

# Xinger®

## Ultra Low Profile 0404 Balun 50Ω to 200Ω Balanced

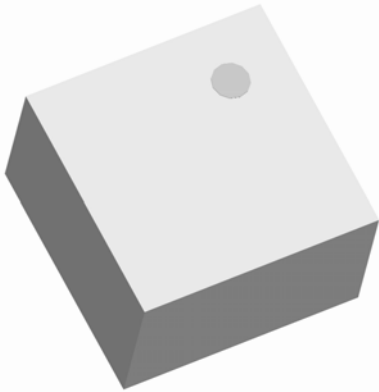

### Description

The BD2425N50200A00 is a low cost, low profile sub-miniature unbalanced to balanced transformer designed for differential inputs and output locations on modern chipsets in an easy to use surface mount package. The BD2425N50200A00 is ideal for high volume manufacturing and delivers higher performance than traditional ceramic baluns. The BD2425N50200A00 has an unbalanced port impedance of 50Ω and a 200Ω balanced port impedance. This transformation enables single ended signals to be applied to differential ports on modern integrated chipsets. The output ports have equal amplitude (-3dB) with 180 degree phase differential. The BD2425N50200A00 is available on tape and reel for pick and place high volume manufacturing.

### Detailed Electrical Specifications: Specifications subject to change without notice.

Features:	Parameter	ROOM (25°C)			Unit
		Min.	Typ.	Max	
<ul style="list-style-type: none"> <li>• 2400 – 2500 MHz</li> <li>• 0.65mm Height Profile</li> <li>• 50 Ohm to 2 x 100 Ohm</li> <li>• Low Insertion Loss</li> <li>• 802.11 b+g</li> <li>• MIMO b+g</li> <li>• Bluetooth</li> <li>• Zigbee</li> <li>• Surface Mountable</li> <li>• Tape &amp; Reel</li> <li>• Non-conductive</li> <li>• RoHS Compliant</li> </ul>	Frequency	2400		2500	MHz
	Unbalanced Port Impedance		50		Ω
	Balanced Port Impedance		200		Ω
	Return Loss	21	27		dB
	Insertion Loss*		0.6	0.7	dB
	Amplitude Balance		0.5	1.0	dB
	Phase Balance		2	6	Degrees
	CMRR		29		dB
	Power Handling			1	Watts
	Operating Temperature	-55		+85	°C

\* Insertion Loss stated at room temperature (Insertion Loss is approximately 0.1 dB higher at +85 °C)

### Outline Drawing

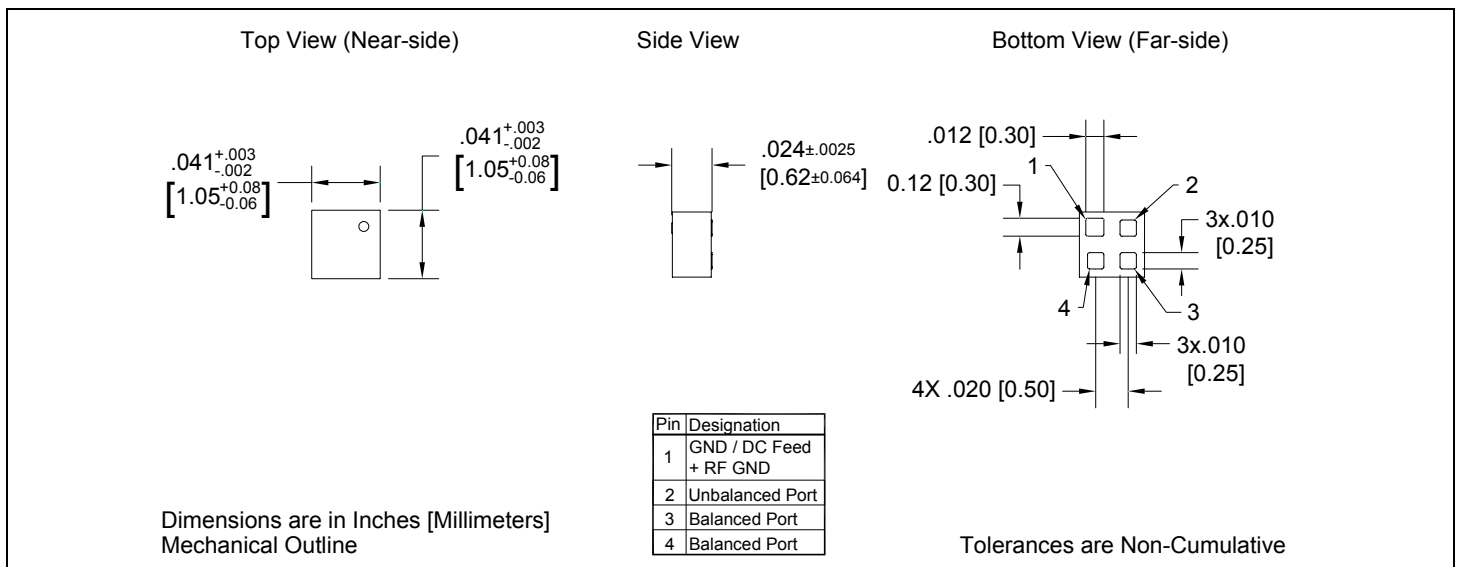

Typical Performance: 2400 MHz. to 2500 MHz.

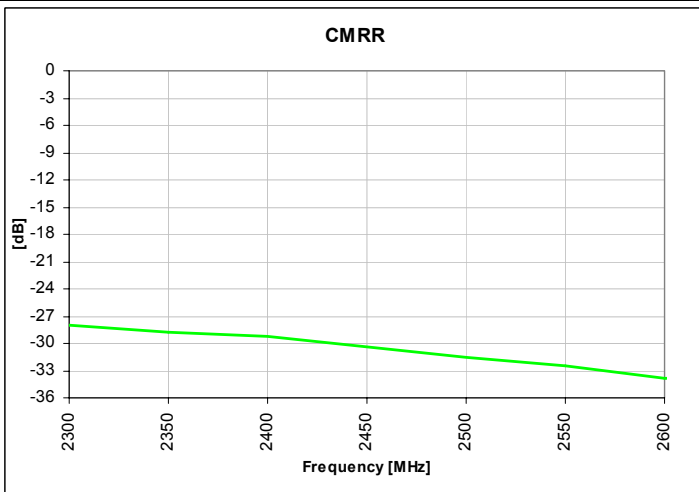
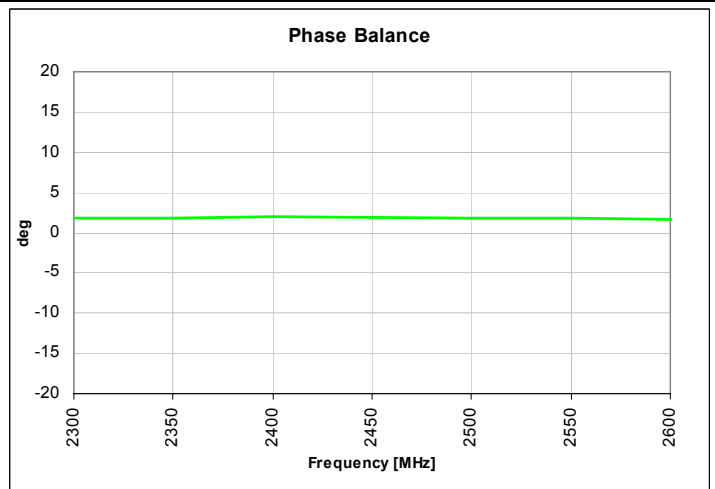
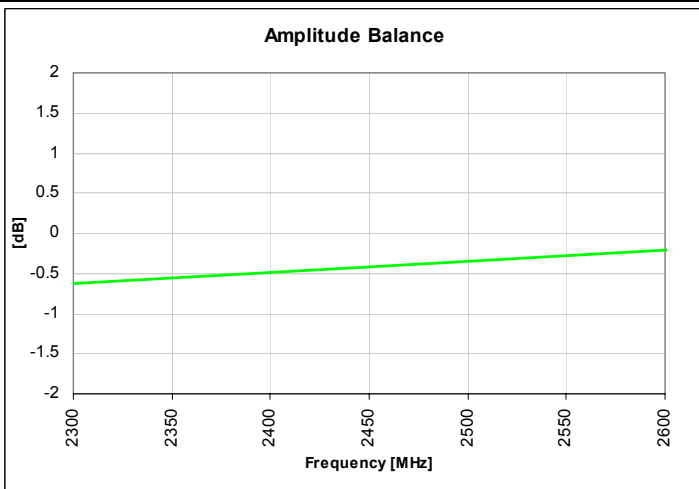
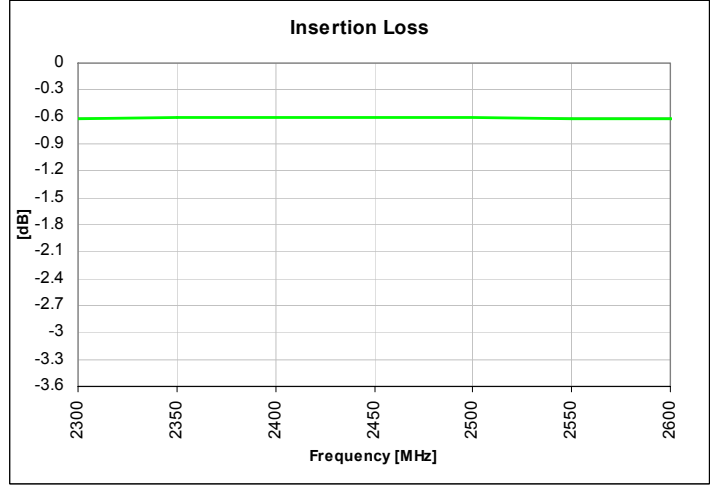
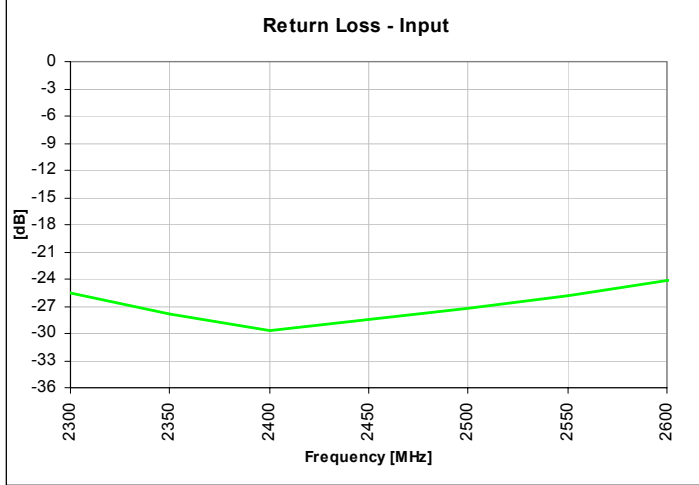

### Wide Band Performance: 500 MHz. to 8500 MHz.

**Insertion Loss**

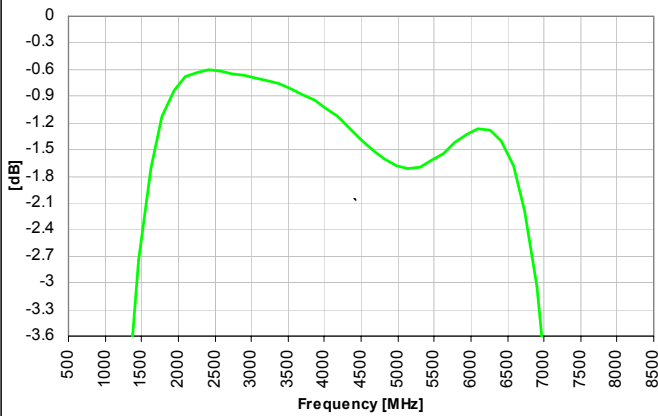

**Return Loss - Input**

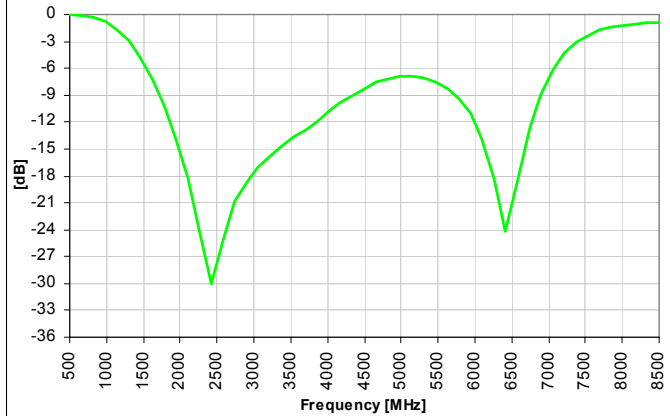

**Amplitude Balance**

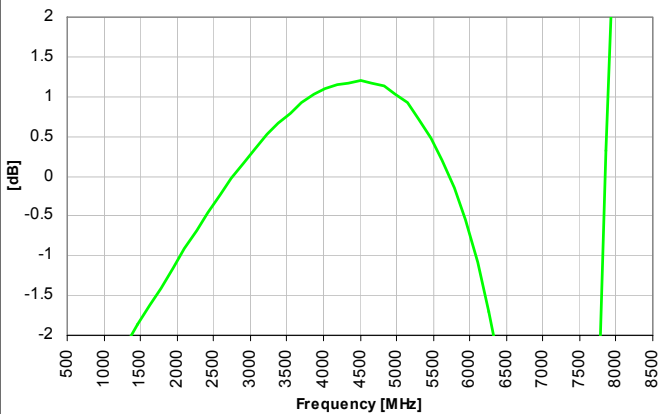

**Phase Balance**

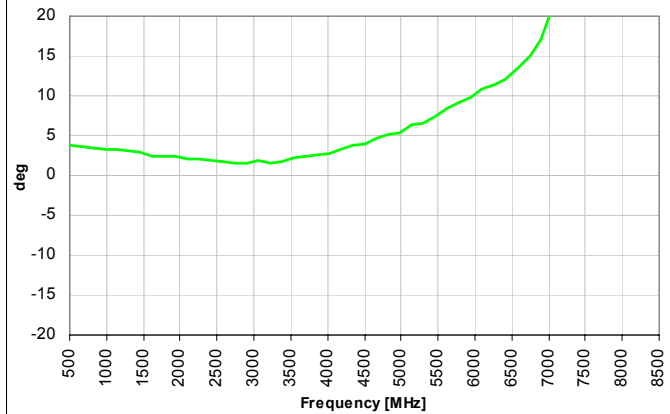

**CMRR**

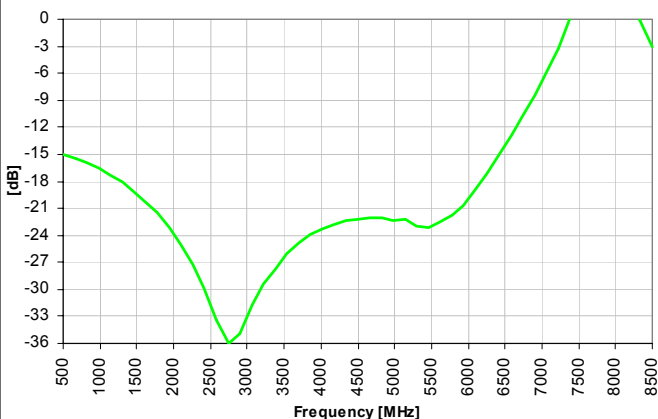

**Mounting Configuration:**

In order for Xinger surface mount components to work optimally, the proper impedance transmission lines must be used to connect to the RF ports. If this condition is not satisfied, insertion loss, Isolation and VSWR may not meet published specifications.

All of the Xinger components are constructed from ceramic filled PTFE composites which possess excellent electrical and mechanical stability having X and Y thermal coefficient of expansion (CTE) of 17 ppm/°C.

An example of the PCB footprint used in the testing of these parts is shown below. An example of a DC-biased footprint is also shown below. In specific designs, the transmission line widths need to be adjusted to the unique dielectric coefficients and thicknesses as well as varying pick and place equipment tolerances

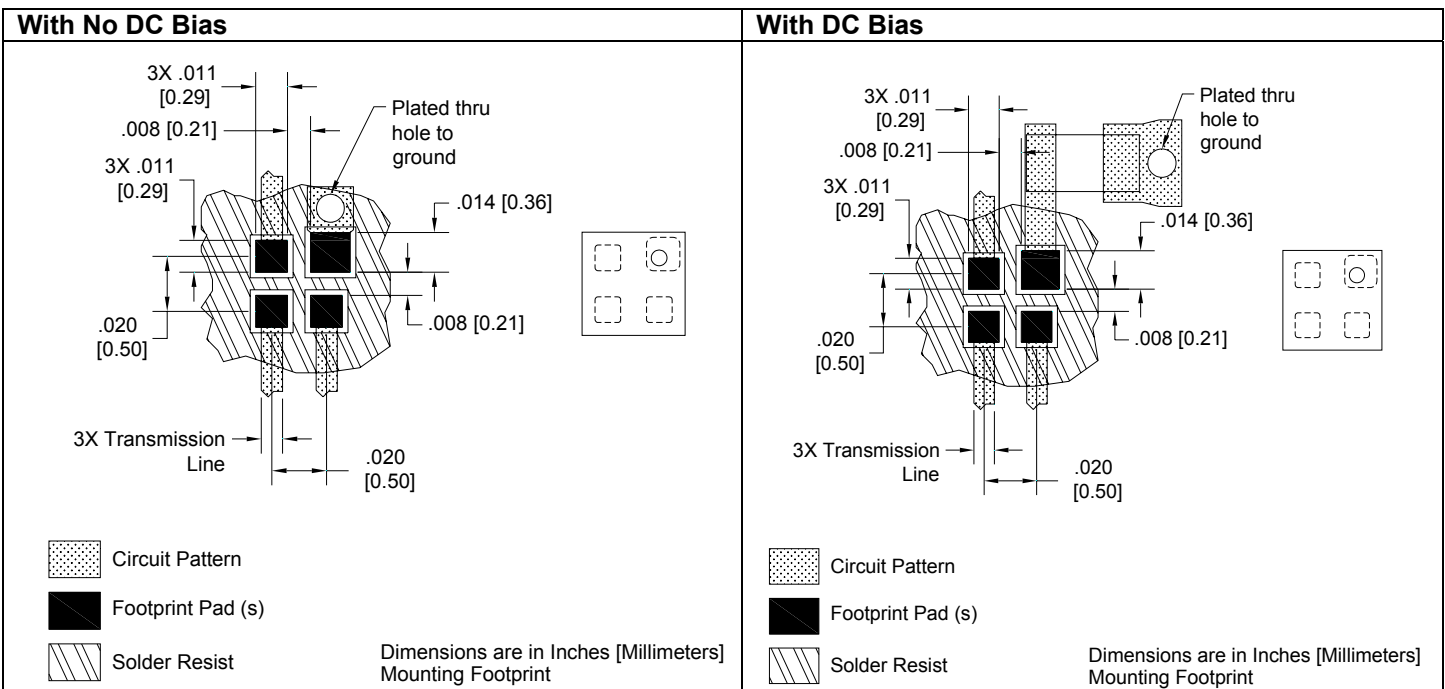

### Packaging and Ordering Information

Parts are available in reel and are packaged per EIA 481-2. Parts are oriented in tape and reel as shown below. Minimum order quantities are 4000 per reel. See Model Numbers below for further ordering information.

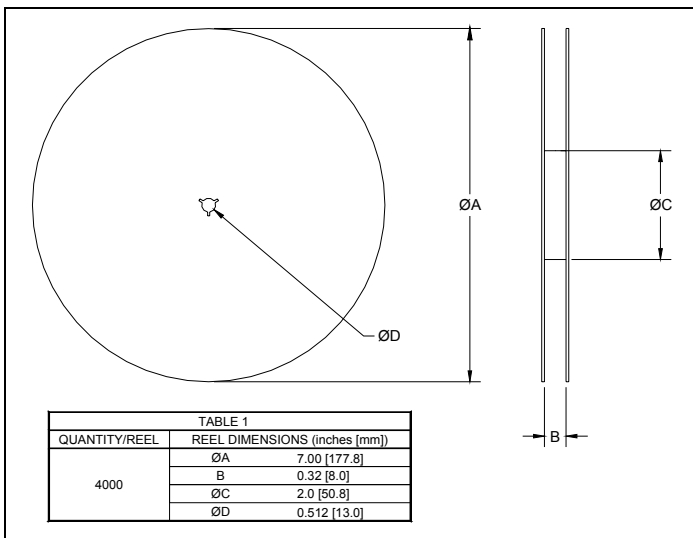
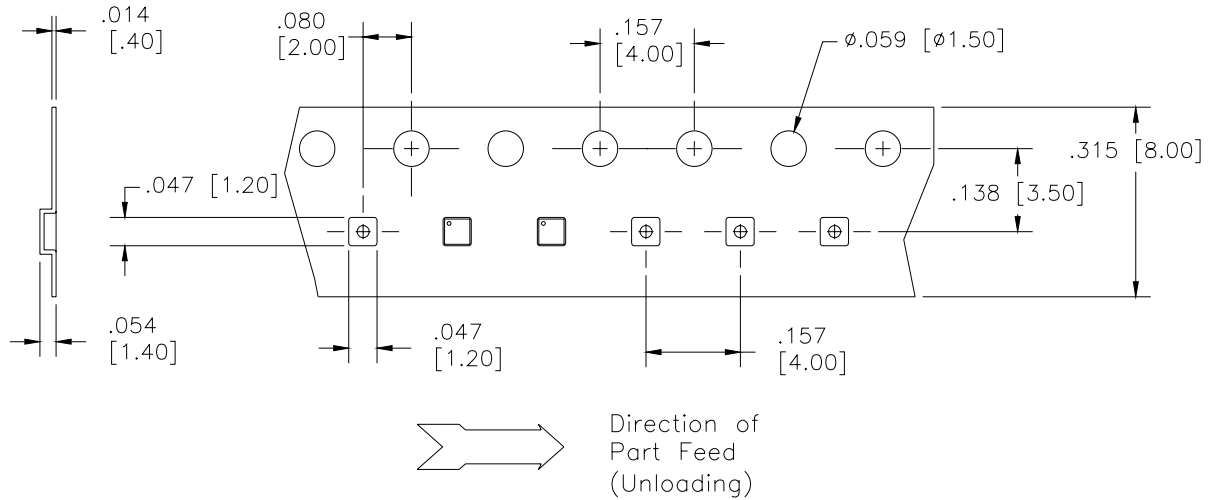

# BD 2425 J 50 100 A 00

Function	Frequency	Package Dimensions	Unbalanced Impedance	Balanced Impedance + Coupling	Plating Finish	Codes
<b>B = Balun</b> <b>BD = Balun + DC</b> <b>F = Filter</b> <b>FB = Filter / Balun</b> <b>C = 3dB Coupler</b> <b>DC = Directional</b> <b>J = RF Jumper</b> <b>X = RF cross over</b>	<b>0110 = 100 – 1000 MHz</b> <b>0810 = 800 – 1000 MHz</b> <b>0922 = 950 – 2150 MHz</b> <b>0826 = 800 – 6200 MHz</b> <b>1222 = 1200 – 2200 MHz</b> <b>1416 = 1400 – 1600 MHz</b> <b>1722 = 1700 – 2200 MHz</b> <b>2326 = 2300 – 2600 MHz</b> <b>2425 = 2400 – 2500 MHz</b> <b>3150 = 3100 – 5000 MHz</b> <b>3436 = 3400 – 3600 MHz</b> <b>4859 = 4800 – 5900MHz</b> <b>5153 = 5100 – 5300 MHz</b> <b>5159 = 5100 – 5900 MHz</b> <b>5759 = 5700 – 5900 MHz</b>	<b>A = 150 x 150 mils</b> <small>(4mm x 4mm)</small> <b>C = 120 x 120 mils</b> <small>(3mm x 3mm)</small> <b>E = 100 x 80 mils</b> <small>(2.5mm x 2mm)</small> <b>J = 80 x 50 mils</b> <small>(2mm x 1.25mm)</small> <b>L = 60 x 30 mils</b> <small>(1.5mm x 0.75mm)</small> <b>N = 40 x 40 mils</b> <small>(1mm x 1mm)</small>	<b>50 = 50 Ohm</b> <b>75 = 75 Ohm</b>	<b>25 = 25 Ω Balanced</b> <b>30 = 30 Ω Balanced</b> <b>50 = 50 Ω Balanced</b> <b>75 = 75 Ω Balanced</b> <b>100 = 100 Ω Balanced</b> <b>150 = 150 Ω Balanced</b> <b>200 = 200 Ω Balanced</b> <b>300 = 300 Ω Balanced</b> <b>400 = 400 Ω Balanced</b> <b>03 = 3dB Hybrid</b> <b>10 = 10dB Directional</b> <b>20 = 20dB Directional</b>	<b>A = Gold</b> <b>P = Tin-Lead</b>	

USA/Canada: (315) 432-8909  
 Toll Free: (800) 411-6596  
 Europe: +44 2392-232392

Available on Tape and Reel for Pick and Place Manufacturing.



**Anaren**

What'll we think of next?™