

***LCD Controllers /Drivers***

***Liquid Crystal Display***

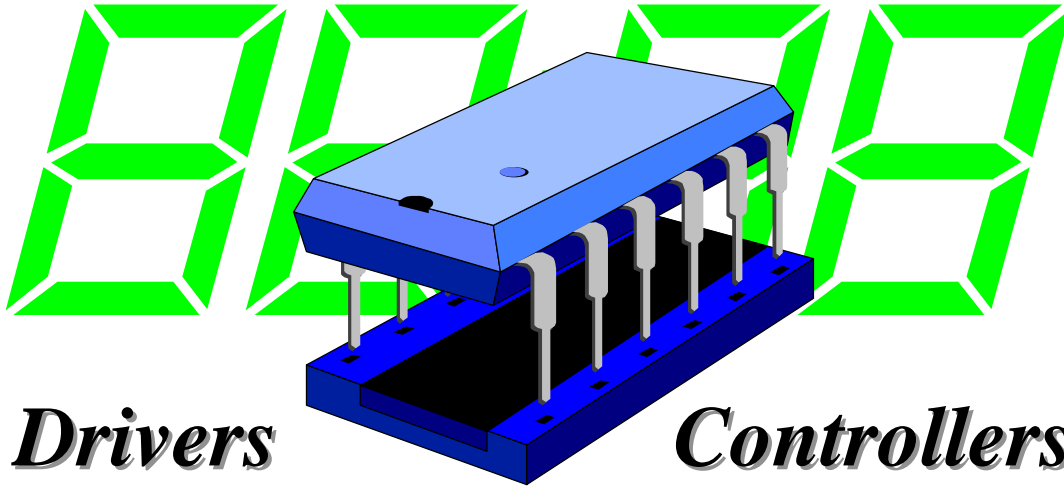

***SHORT FORM***

<b><u>Contents</u></b>	
<b><i>General Overview .....</i></b>	<b><i>2</i></b>
<b><i>Column Drivers .....</i></b>	<b><i>3</i></b>
<b><i>Common Drivers .....</i></b>	<b><i>4</i></b>
<b><i>Segment Controllers .....</i></b>	<b><i>5</i></b>
<b><i>Dot Matrix Character Controllers .....</i></b>	<b><i>6</i></b>
<b><i>New Products .....</i></b>	<b><i>7</i></b>
<b><i>Package Technology .....</i></b>	<b><i>8</i></b>
<b><i>Line-up / Product Codes .....</i></b>	<b><i>9</i></b>

# LCD Controllers /Drivers

## GENERAL OVERVIEW

Hitachi's family of LCD controllers and drivers is divided into three different product groups. Each group has different features, so that it is possible to cover a wide range of applications in different segments.

The first group of Column/Common drivers is able to control a wide variety of graphic type displays. Good compatibility between these products provides a great flexibility of driving different display configurations.

When driving Dot Matrix Character displays there is a second product group available which is based on the popular LCDII (HD44780).

Finally, the third group is dedicated for standard 7-segment displays which are often used in low-end consumer applications.

Nowadays, it is extremely important that LCD controllers incorporate technical features such as 3V operation, DC-DC converter, keypad-scan, TCP technology etc. to follow the trend of current and future applications. The main applications can be seen in the telecom area (feature phone, all types of handy phone) and in the automotive area (dashboard, car radio). Further applications can be identified in the consumer, office automation and industrial market due to the change to more highly sophisticated and mixed-structure displays. All these demands are covered by Hitachi's LCD controllers, a very well established product family which fits to the LCD concepts for the future.

## THE FAMILY

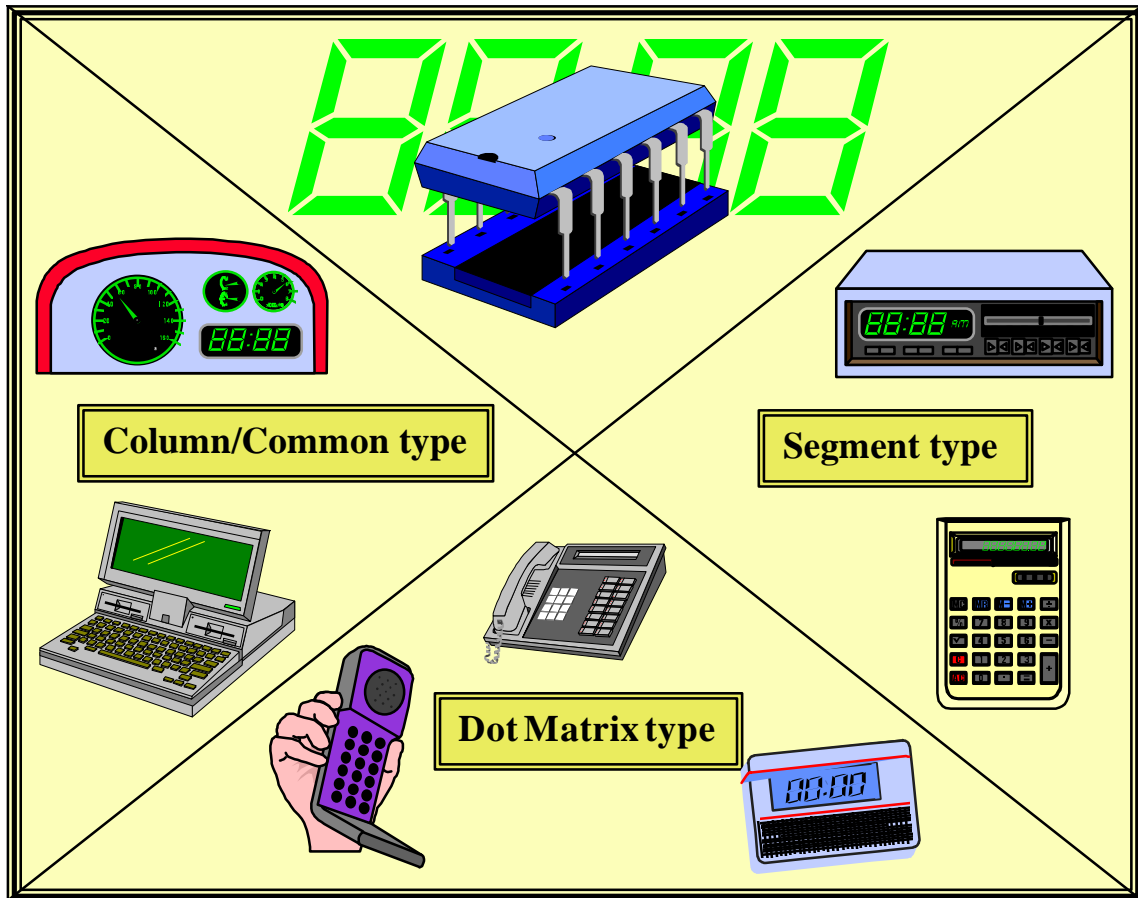

# *LCD Controllers /Drivers*

## COLUMN DRIVERS

Column (and Common) LCD drivers are able to drive small, medium and large graphic-type LCD panels.

Usually small and medium displays have multiplex ratios (Duty) from Static drive up to 1/64 whereas large displays can be multiplexed from 1/64 up to 1/480.

The Column driver group falls into three sub-groups which are suitable for different display types and configurations. These are drivers to extend the display driving capability, drivers with on-chip display RAM for direct output of display data and drivers with a high pin-count for high resolution displays.

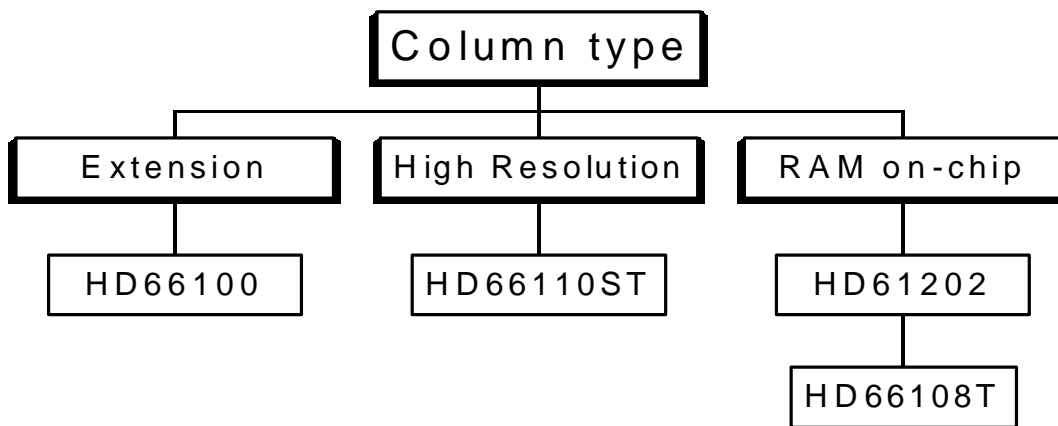

Device Name	HD 66100	HD 66110ST	HD 61202	HD 66108T
Supply Voltage (V)	4.5 - 5.5	2.7 - 5.5	4.5 - 5.5	2.7 - 5.5
LCD Voltage (V)	6	40	17	15
Duty	Static - 1/ 16	1/ 100 - 1/ 480	1/ 32 - 1/ 128	1/ 32 - 1/ 64
ROM	---	---	---	---
RAM	---	---	512 x 8	165 x 65
Column Lines	80	160	64	100 - 165
Common Lines	---	---	---	0 - 65
Features	---	---	Display RAM	Display RAM Timing Circuit
Package Types	FP-100	Slim -TCP-191	FP-100 TFP-100	TCP-208

# LCD Controllers /Drivers

## COMMON DRIVERS

Common drivers can be easily combined with the respective Column drivers to configure the required display application. For example, the technical solution to drive a graphic display with 128x64 dots consists of three devices only. One HD61203 with 64 common outputs,

on-chip timing circuit and data interface to the microcontroller together with two additional column drivers HD61602 with 64 column outputs each and the respective display RAM on-chip are necessary to build up the overall display system.

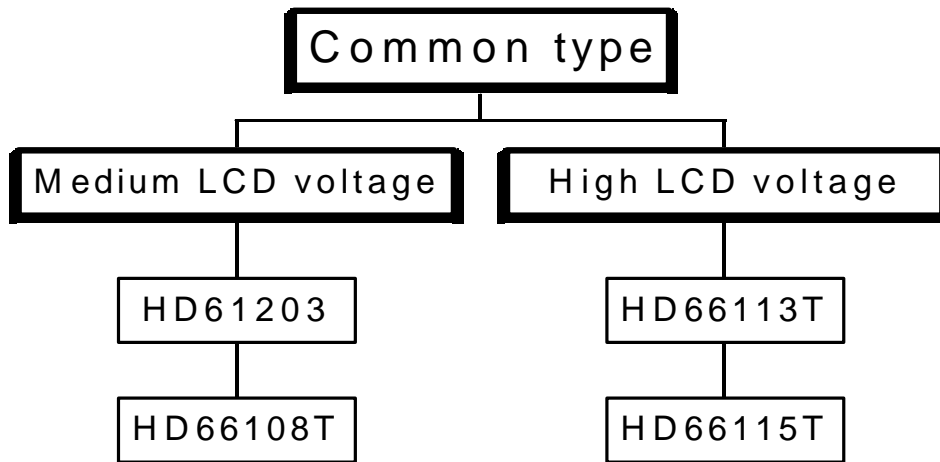

Device Name	HD 66113T	HD 66115T	HD 61203	HD 66108T
Supply Voltage (V)	2.7 - 5.5	2.7 - 5.5	4.5 - 5.5	2.7 - 5.5
LCD Voltage (V)	40	40	17	15
Duty	1/ 100 - 1/ 480	1/ 100 - 1/ 480	1/ 32 - 1/ 64	1/ 32 - 1/ 64
ROM	---	---	---	---
RAM	---	---	---	165 x 65
Column Lines	---	---	---	100 - 165
Common Lines	120	160	64	0 - 65
Features	---	---	Timing Circuit	Display RAM Timing Circuit
Package Types	Slim -TCP-140	Slim -TCP-181	FP-100 TFP-100	TCP-208

# *LCD Controllers /Drivers*

## SEGMENT CONTROLLERS

Segment LCD drivers from Hitachi are able to drive 7-segment displays from 51 segments in static mode up to 208 segments in 1/4 duty mode. These products fit perfectly to battery-

driven applications due to features like 3V operation, standby operation, low voltage static display RAM and on-chip power supply circuit for the liquid display driver

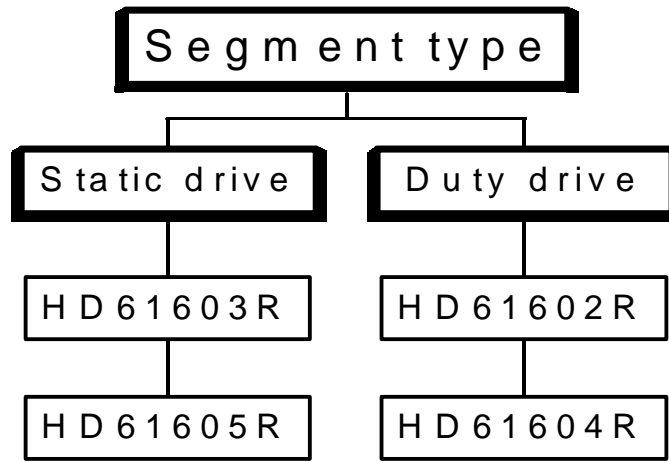

Device Name	HD61602R	HD61603R	HD61604R	HD61605R
Supply Voltage (V)	2.7 - 5.5	2.7 - 5.5	4.5 - 5.5	4.5 - 5.5
LCD Voltage (V)	5	5	5	5
Duty	Static - 1/4	Static	Static - 1/4	Static
ROM	---	---	---	---
RAM	204	64	204	64
Column Lines	51	64	51	64
Common Lines	4	1	4	1
Features	Display RAM	Timing Circuit	Standby Mode	Bus Interface
Package Types	FP-80	FP-80	FP-80	FP-80

# LCD Controllers /Drivers

## DOT MATRIX CONTROLLERS

Dot Matrix Character Controllers can display 5x8 dots and 5x11 dots characters as well as standard segments. This brings a high flexibility in driving complex displays with one, two or four character lines plus additional icons. These products are equipped with features such

as character RAM/ROM, 3V operation, low power modes, serial/parallel communication interface, DC-DC converter and extension facilities. Furthermore there are different character sets available as well as the option to provide a custom character MASK ROM.

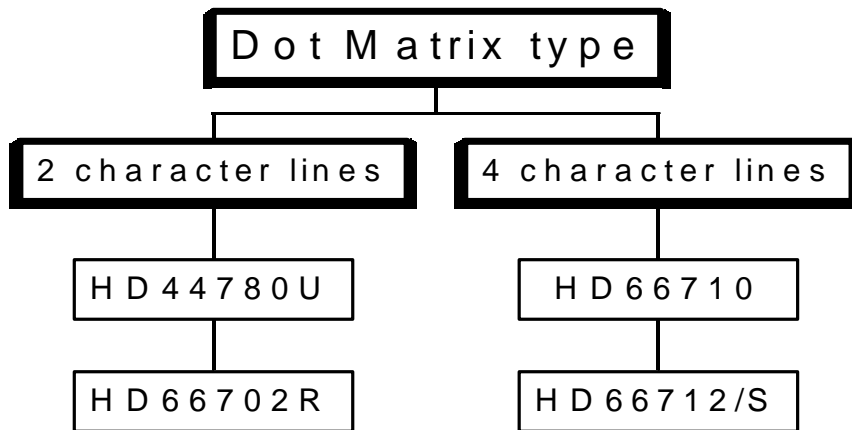

Device Name	HD44780U	HD66702R	HD66710	HD66712/S
Supply Voltage (V)	2.7 - 5.5	2.7 - 5.5	2.7 - 5.5	2.7 - 5.5
LCD Voltage (V)	3 - 11	3 - 7	3 - 13	3 - 13
Duty	1/ 8 - 1/ 16	1/ 8 - 1/ 16	1/ 17 - 1/ 33	1/ 17 - 1/ 33
ROM	9920	7200	9600	9600
RAM	64 + 80	64 + 80	64 + 80	64 + 80
Column Lines	40	100	40	60
Common Lines	16	16	33	33
Features	Mask	Mask	Mask, LPM DC-DC, SD	Mask, LPM DC-DC, SCI, SD
Package Types	FP-80	FP-144	FP-100 TFP-100	FP-128 TCP-128

# LCD Controllers /Drivers

## NEW PRODUCTS

Concentrating on mixed-structure and high resolution graphic displays, Hitachi will develop three new Dot Matrix controllers and five new Column/Common type drivers.

These are

Dot Matrix: HD66720, HD66717, HD66730

Column: HD66112, HD66120, HD66520

Common: HD66503, HD66410

Features like Keypad Scan (KS), Low Power Modes (LPM), LED Drive (LD), DC-DC Converter (DC-DC), Serial Communications Interface (SCI) and Static Segment Drive (SSD or SD) are standard now. By providing these functions, these new devices allow the configuration of highly integrated display systems in telecom and consumer applications

### **DOT MATRIX**

- **HD66720**
- **HD66717**
- **HD66730**

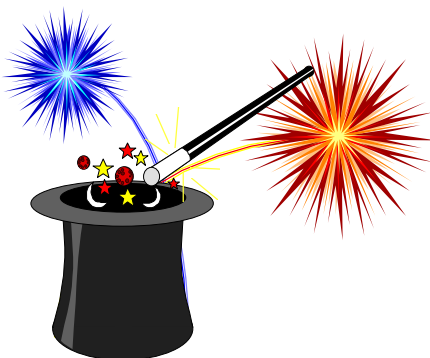

### **COLUMN/COMMON**

- **HD66520**
- **HD66503**
- **HD66112**
- **HD66120**
- **HD66410**

Device Name	HD66720	HD66717	HD66730	HD66112	HD66120	HD66410	HD66503	HD66520
Supply Voltage (V)	2.7 - 5.5	2.7 - 5.5	2.7 - 5.5	2.7 - 5.5	2.7 - 5.5	2.2 - 3.6	2.7 - 5.5	3.0 - 3.6
LCD Voltage (V)	3 - 11	3 - 7	3 - 13	14 - 40	14 - 40	3 - 13	8 - 28	8 - 28
Duty	1/ 8 - 1/ 16	1/ 8 - 1/ 16	1/ 14 - 1/ 53	1/ 100-1/ 480	1/ 100-1/ 480	1/ 17 - 1/ 33	1/ 120-1/ 240	1/ 64 -1/ 240
ROM x 1	9920	7200	510K	---	---	---	---	---
RAM x 8	64 + 40	64 + 80	208 + 80	---	---	528	---	76800
Column Lines	40	100	71	160	240	128	---	160
Common Lines	16	16	26	---	---	33	240	---
Features	Mask SSD, SD, LD SCI, DC-DC	Mask KPS, SD, LD SCI, DC-DC	Kanji Mask SD, SCI DC-DC	---	---	SD, DC-DC Disp. RAM	LCD Timing Circuit	Disp. RAM Grey-scale
Package Types	FP-80	FP-144	FP-128	Slim- TCP 191	Slim- TCP 271	TCP-239	TCP-272	TCP-208

Please contact Hitachi sales office for availability of all devices

# ***LCD Controllers /Drivers***

## **PACKAGE TECHNOLOGY**

Generally, Hitachi's LCD controllers/drivers are available in QFP and TQFP (1.2mm high) packages. Following the market trend to increase the pin-count and to decrease the package size, the Tape Carrier packages (TCP) have been developed. TCP is the generic name for packages fabricated by TAB technology (Tape Automatic Bonding), using a tape wired with copper-foil patterns. This designation has been adopted by the EIAJ Semiconductor External Standards Committee.

Compared to conventional packages the structure and the materials of TCP provide the following features:

1. Lightweight
2. Thin
3. Fine pitch capability
4. Flexible design

Fine pitch leads mean a reduced pad pitch on the device, enabling more functionality to be put into the same package size. Combined with thickness less than 1.0mm (typically 0.65mm), this feature translates into thinner LCD modules with higher definition, or into compact, high performance systems.

Flexible design includes the possibility of customisation of pattern layout and TCP design. Currently, Hitachi offers tape-carrier-packaged LCD products for Graphic and Dot Matrix Character displays.

These LCD drivers combine a device that withstands high voltages and gives high definition and a tape carrier package which promises excellent reliability, making possible applications that would not be feasible with a conventional QFP.

## **TAPE CARRIER PACKAGES**



# LCD Controllers /Drivers

## LINE-UP / PRODUCT CODES

<u>COLUMN</u>					
Part name	Package	Comment	Part name	Package	Comment
HD66100F	1420-QFP-100	FP-100A package	HD61202	1420-QFP-100	Standard
HD66100FH	1414-QFP-100	FP-100B package	HD61202TFIA	1420-TQFP-100	TFP-package
HD66110STB0*	Slim-TCP-189	92µm pitch	HD66108T00	TCP-208	400µm pitch
HD66110STB2*	Slim-TCP-189	92µm pitch	HD66108TA0	TCP-208	280µm pitch
HD66110STB4*	Slim-TCP-189	80µm pitch	HD66108TB0	TCP-208	250µm pitch-fold
HD66110STB5	Slim-TCP-189	180µm pitch	HD66108Txx*	TCP-208	Custom TCP
HD66110STB8*	Slim-TCP-189	200µm pitch			
HD66110STBx*	Slim-TCP-189	Custom TCP			
<u>COMMON</u>					
Part name	Package	Comment	Part name	Package	Comment
HD61203	1420-QFP-100	Standard	HD66113TA0	TCP-140	190µm pitch
HD61203J	1420-QFP-100	J-Temp. spec.	HD66113TA1*	TCP-140	240µm pitch
HD61203TFIA	1420-TQFP-100	TFP-package	HD66113Txx*	TCP-140	Custom TCP
HD66108T00	TCP-208	400µm pitch	HD66115TA0	TCP-181	180µm pitch
HD66108TA0	TCP-208	280µm pitch	HD66115TA1*	TCP-181	250µm pitch
HD66108TB0	TCP-208	250µm pitch-fold	HD66115TA3*	TCP-181	250µm pitch
HD66108Txx*	TCP-208	Custom TCP	HD66115Txx*	TCP-181	Custom TCP
<u>SEGMENT</u>					
Part name	Package	Comment	Part name	Package	Comment
HD61602R	1420-QFP-80	Standard	HD61604R	1420-QFP-80	Standard
HD61603R	1420-QFP-80	Standard	HD61605R	1420-QFP-80	Standard
<u>DOT MATRIX</u>					
Part name	Package	Comment	Part name	Package	Comment
HD44780UA00FS	1420-QFP-80	Standard Mask	HD66710A00FS	1420-QFP-100	Standard Mask
HD44780UA0xFS	1420-QFP-80	Mask 01/02	HD66710BxxFS	1420-QFP-100	Custom Mask
HD44780UBxxFS*	1420-QFP-80	Custom Mask	HD66712A00TA0	TCP-128	Standard Mask
HD66702RA00F	2020-QFP-144	Standard Mask	HD66712A0xTA0	TCP-128	Mask 01/02
HD66702RA00FL	2020-QFP-144	Standard Mask	HD66712BxxTA0	TCP-128	Custom Mask
HD66702RA0xF	2020-QFP-144	Mask 01/02	HD66712A00FS	1420-QFP-128	Standard Mask
HD66702RBxxF*	2020-QFP-144	Custom Mask	HD66712A0xFS	1420-QFP-128	Mask 01/02
HD66702RBxxFL*	2020-QFP-144	Custom Mask	HD66712BxxFS	1420-QFP-128	Custom Mask

\* Please contact Hitachi sales office for availability