

STANDARD RECOVERY DIODES

Stud Version

Features

- Alloy diode
- Peak reverse voltage up to 1000V
- Popular series for rough service
- Standard JEDEC types
- Stud cathode and stud anode version

250A
300A

Typical Applications

- Welders
- Power supplies
- Motor controls
- Battery chargers
- General industrial current rectification

Major Ratings and Characteristics

Parameters	70U	300U	Units
$I_{F(AV)}$	250	300	A
@ T_C	150	130	°C
I_{FSM} @ 50Hz	6550		A
@ 60Hz	6850		A
I^2t @ 50Hz	214		KA ² s
@ 60Hz	195		KA ² s
V_{RRM} range	100 to 1000	50 to 1000	V
T_J	-65 to 200		°C

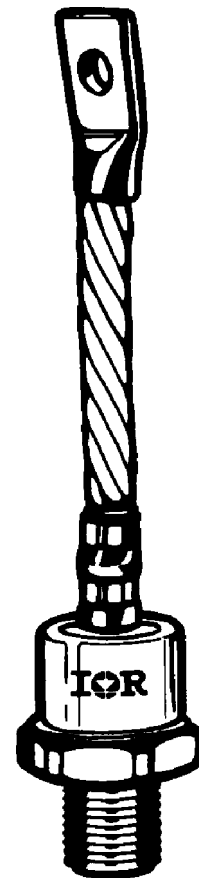

case style
DO-205AB (DO-9)

ELECTRICAL SPECIFICATIONS

Voltage Ratings

Type number *	Voltage Code	V_{RRM} , maximum repetitive peak reverse voltage V	V_{RSM} , maximum non-repetitive peak rev. voltage V	I_{RRM} max. $T_J = 200^\circ\text{C}$ mA
70U	10	100	200	60
	20	200	300	
	40	400	500	
	60	600	720	
	80	800	960	
	100	1000	1200	
Type number	Voltage Code	V_{RRM} , maximum repetitive peak reverse voltage V	V_{RSM} , maximum non-repetitive peak rev. voltage V	I_{RRM} max. $T_J = 175^\circ\text{C}$ mA
300U	5	50	100	40
	10	100	200	40
	20	200	300	40
	30	300	400	40
	40	400	500	40
	60	600	720	40
	80	800	960	35
	100	1000	1200	30

* Also available as JEDEC series: 1N3735 through 1N3743; 1N2054 through 1N2068; 1N4044 through 1N4056.

Forward Conduction

Parameter	70U	300U	Units	Conditions
$I_{F(AV)}$ Max. average forward current @ Case temperature	250	300	A	180° conduction, half sine wave
	150	130	°C	
I_{FSM} Max. peak, one-cycle forward, non-repetitive surge current	6550	A	A	t = 10ms No voltage reappplied
	6850			t = 8.3ms reappplied
	5500			t = 10ms 100% V_{RRM} reappplied
	5750			t = 8.3ms reappplied
I^2t Maximum I^2t for fusing	214	KA ² s	KA ² s	t = 10ms No voltage reappplied
	195			t = 8.3ms reappplied
	151			t = 10ms 100% V_{RRM} reappplied
	138			t = 8.3ms reappplied
$I^2\sqrt{t}$ Maximum $I^2\sqrt{t}$ for fusing	2140		KA ² √s	t = 0.1 to 10ms, no voltage reappplied
$V_{F(TO)}$ Max. value of threshold voltage	0.610		V	$T_J = 200^\circ\text{C}$
r_f Max. value of forward slope resistance	0.751		mΩ	
V_{FM} Max. peak forward voltage	1.30	--	V	$(I_{FM} \times \pi \times I_{F(AV)})$ (785A peak), $T_J = 25^\circ\text{C}$
	--	1.40	V	$(I_{FM} \times \pi \times I_{F(AV)})$ (942A peak), $T_J = 25^\circ\text{C}$

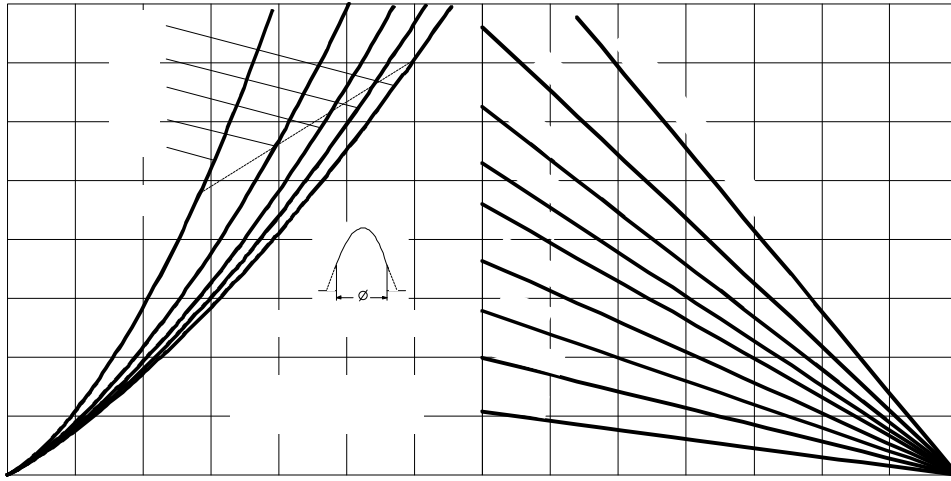

Fig. 3 - Forward Power Loss Characteristics

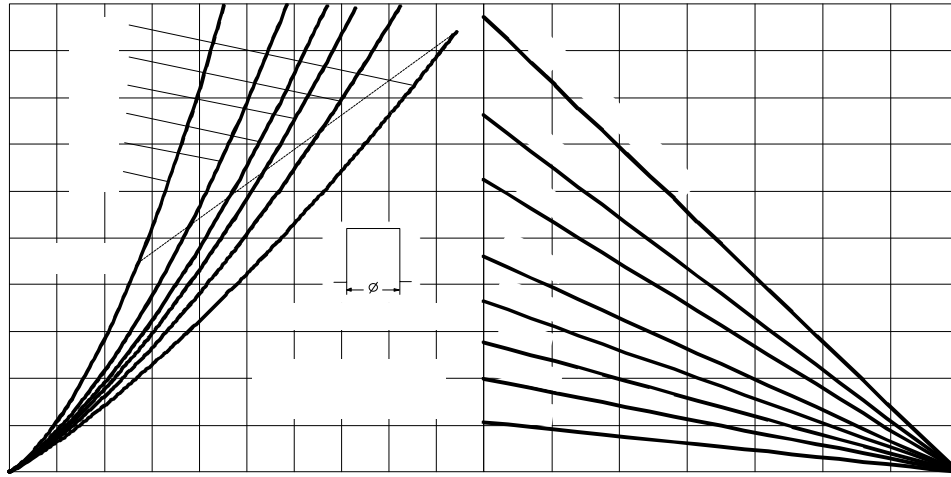
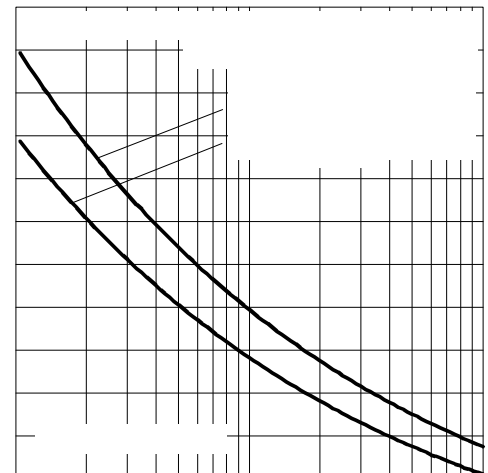
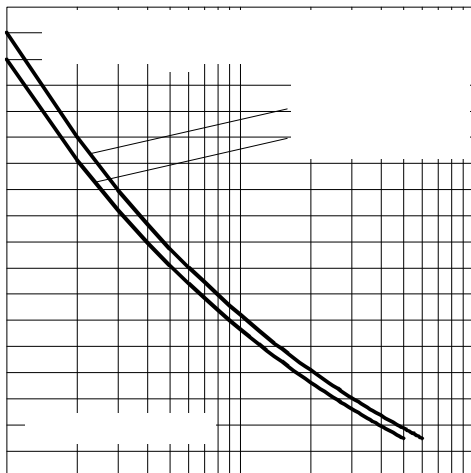

Fig. 4 - Forward Power Loss Characteristics



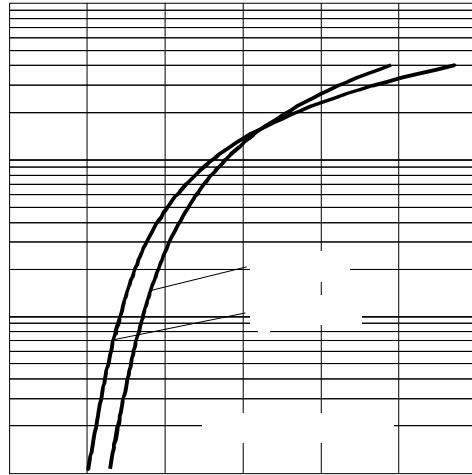
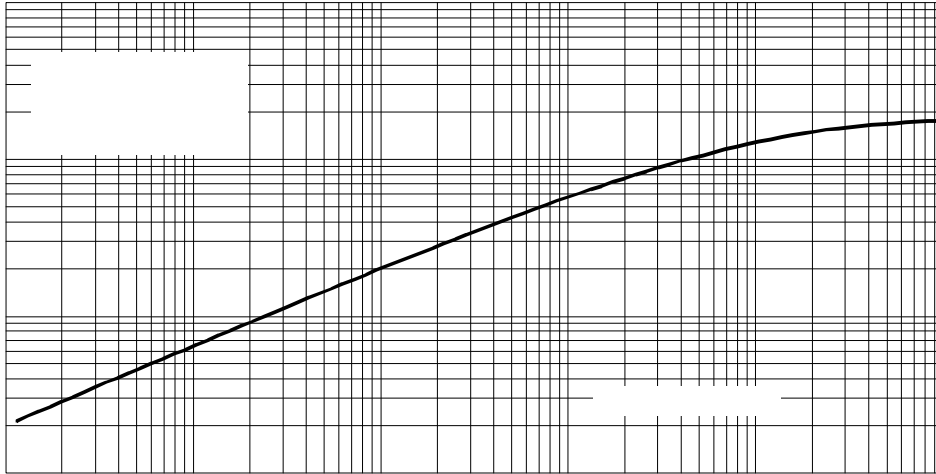

Fig. 7 - Forward Voltage Drop Characteristics

Fig. 8 - Thermal Impedance Z_{thJC} Characteristic

Thermal and Mechanical Specifications

Parameter	70/300U(R)	Units	Conditions
T _J Max. junction operating temperature range	-65 to 200	°C	
T _{stg} Max. storage temperature range	-65 to 200		
R _{thJC} Max. thermal resistance, junction to case	0.18	K/W	DC operation
R _{thCS} Max. thermal resistance, case to heatsink	0.08		Mounting surface, smooth, flat and greased
T Max. allowed mounting torque +0 -20%	37	Nm	Not lubricated threads
	28		Lubricated threads
wt Approximate weight	250	g	
Case style	DO-205AB (DO-9)**		JEDEC (See Outline Table)

** 302U-A uses IR case style B-26

 ΔR_{thJC} Conduction

(The following table shows the increment of thermal resistance R_{thJC} when devices operate at different conduction angles than DC)

Conduction angle	Sinusoidal conduction	Rectangular conduction	Units	Conditions
180°	0.020	0.015	K/W	T _J = T _J max.
120°	0.024	0.025		
90°	0.031	0.034		
60°	0.045	0.047		
30°	0.077	0.077		

Ordering Information Table

Device Code

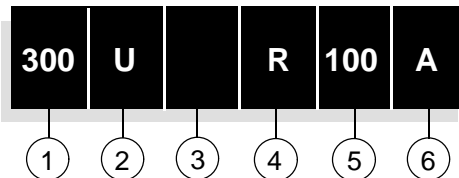

- 1** - 300 = Standard 300U device
70 = Standard 70U device
302 = 300U Top Threaded version
72 = 70U with Pinch Bolt
- 2** - U = Essential Part Number
- 3** - F = Flat Base, available only on 72UF Series
None = Normal Stud
- 4** - R = Stud Reverse Polarity (Anode to Stud)
None = Stud Normal Polarity (Cathode to Stud)
- 5** - Voltage code: Code x 10 = V_{RRM} (See Voltage Ratings table)
- 6** - A = Essential Part Number only for 300U Series
None = 70U Series

NOTE: For longer lead Contact Factory

70/300U(R) Series

Outline Table

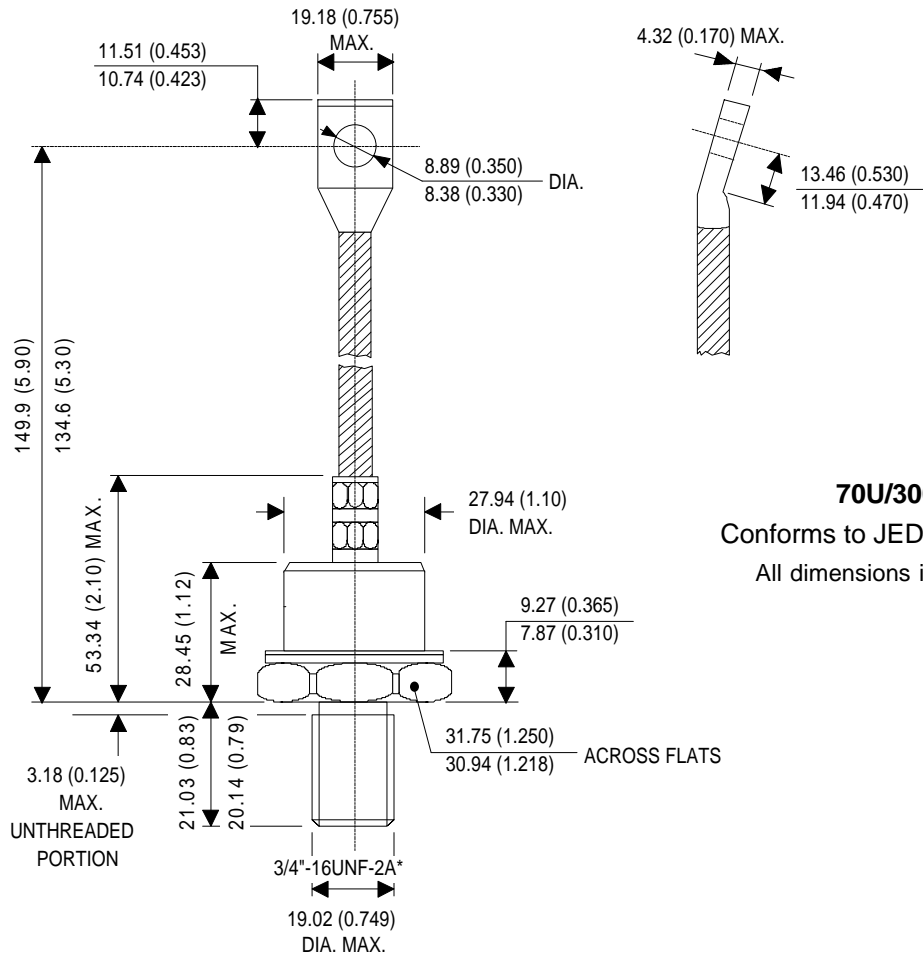

70U/300U-A Series
 Conforms to JEDEC DO-205AB (DO-9)
 All dimensions in millimeters (inches)

* METRIC DEVICE. M16 X 1.5 FOR 300U..AM
 METRIC DEVICE. M20 X 1.5 FOR 300U..AMA

302U-A Series
 IR Case Style B26
 All dimensions in millimeters (inches)

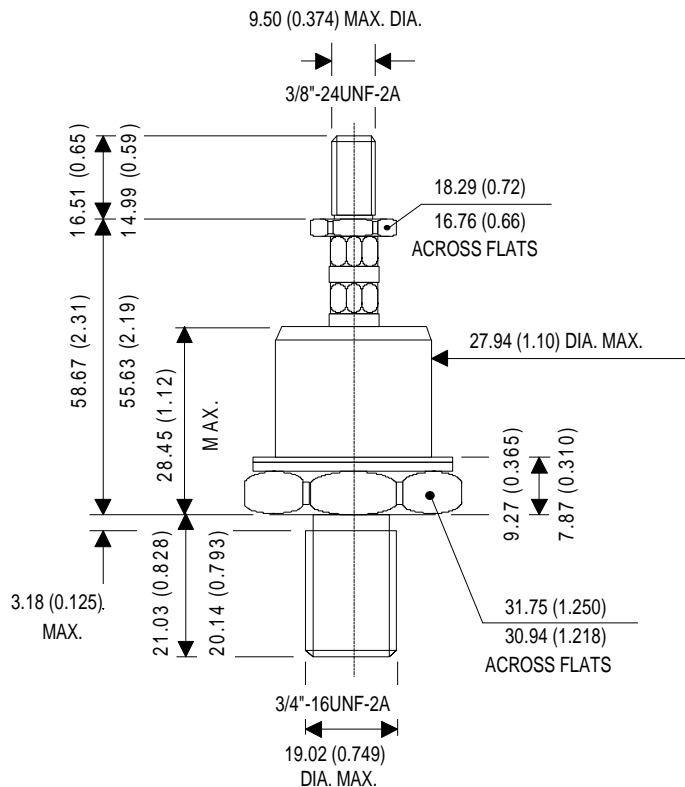

Outline Table

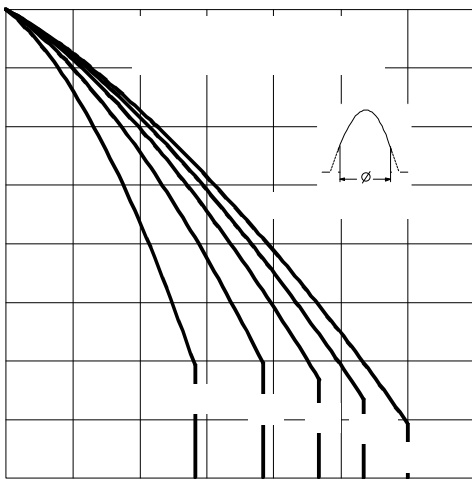
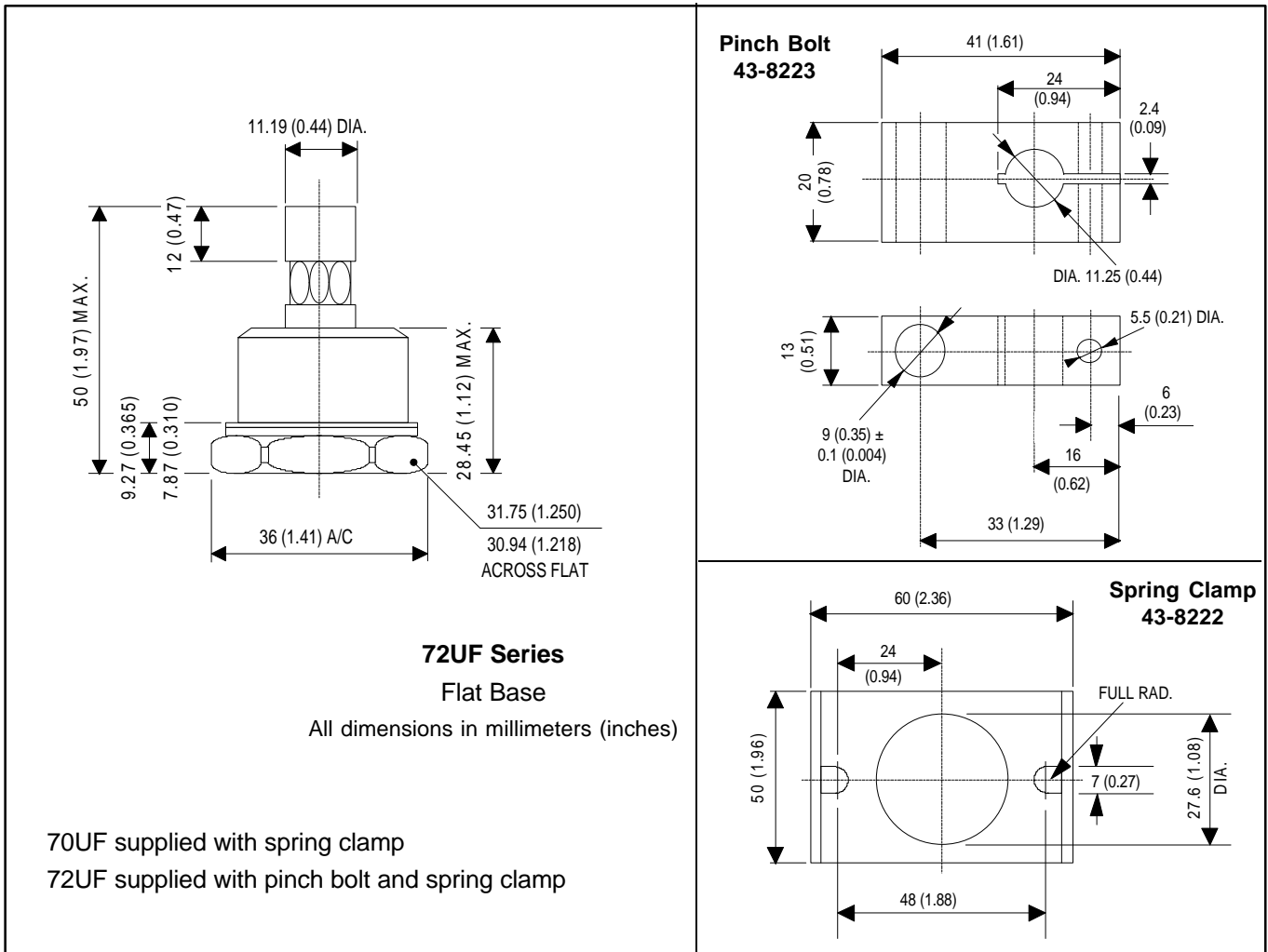

Fig. 1 - Current Ratings Characteristics

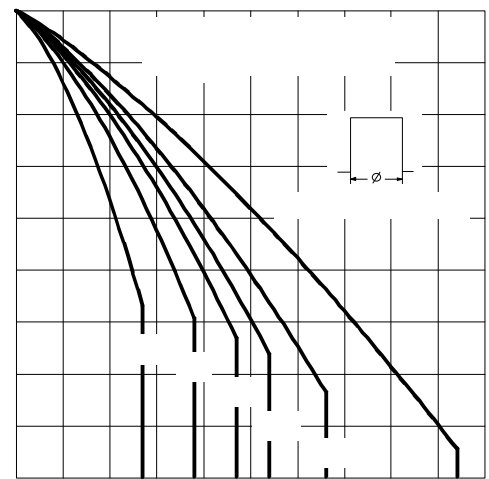

Fig. 2 - Current Ratings Characteristics