

Transistors for TV Display Video Output Use

Features *Excellent HF characteristic. *Small reverse transfer capacitance. *Complementary PNP and NPN types.
*Adoption of MBIT, FBET processes. *Highly resistant to dielectric breakdown.

Case Outline (unit:mm)
SANYO:CP

1:Base, 2:Emitter,
3:Collector

General-Purpose Type (*: Tc=25°C) For PNP, (-) sign is omitted.

Type No.	Package	Absolute Maximum Ratings/Ta=25°C				Electrical Characteristics/Ta=25°C					
		V _{CB0} (V)	V _{CEO} (V)	I _C (A)	P _C (W)	f _T typ (MHz)	V _{CE} / I _C (V/mA)	C _{ob} typ (PF)	C _{re} (PF)	V _{CB} (V)	h _{FE}
2SC2857	N P	180	180	50m	0.5	min50	30 / 10	4	-	10	40 ~ 320
2SA1689/2SC4449		300	300	50m	0.6	70	30 / 10	2.4/1.5	1.5/1	30	100 ~ 320
2SC5291	FLP	180	160	1.5	1.5	120	10 / 50	14	-	10	100 ~ 400
2SC4075	TO-220ML	300	300	0.2	*10	min50	30 / 10	5.3	-	50	40 ~ 200

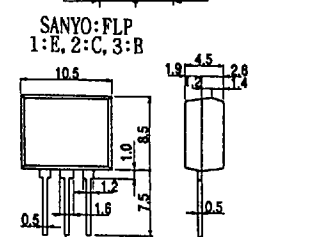
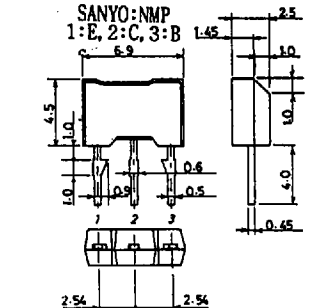
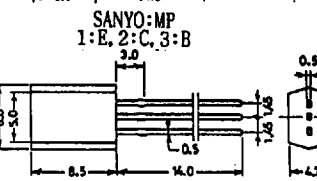
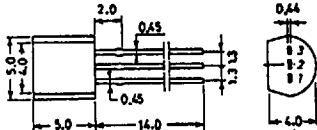
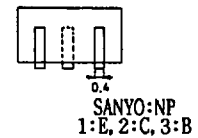
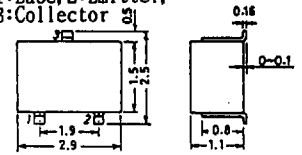

High-Definition CRT Display Use

2SA1580/2SC4104	C P	70	60	50m	0.2	700	10 / 10	1.7/1.3	1.3/1	10	60 ~ 270
2SA1433/2SC3504	M P				0.9	700	10 / 10	1.7	1.3/1	10	60 ~ 320
2SA1370/2SC3467		N P	200	200	0.1	1.0	150	30 / 10	2.6/1.7	1.7/1.2	30
2SA1371/2SC3468	NMP		300	300	0.1	1.0	150	30 / 10	3.1/2.6	2.3/1.8	30
2SA1710/2SC4490		FLP	300	300	0.1	1.0	70	30 / 10	3.1/2.6	2.3/1.8	30
2SA1787/2SC4650	TO-126		200	200	0.1	1.0	150	30 / 10	2.6/1.7	1.7/1.2	30
2SA1828/2SC4732		TO-126ML	200	200	0.1	1.3	150	30 / 10	2.6/1.7	1.7/1.2	30
2SA1829/2SC4733	TO-220		300	300	0.1	1.3	150	30 / 10	3.1/2.6	2.3/1.8	30
2SC4884		TO-220	300	300	0.1	1.5	70	30 / 10	2.6	1.8	30
2SA1352/2SC3416	TO-220		200	200	0.1	1.2	70	30 / 10	2.6/1.7	1.7/1.2	30
2SA1353/2SC3417		TO-220	300	300	0.1	1.2	70	30 / 10	3.1/2.6	2.3/1.8	30
2SA1380/2SC3502	TO-220		200	200	0.1	1.2	150	30 / 10	2.6/1.7	1.7/1.2	30
2SA1381/2SC3503		TO-220	300	300	0.1	1.2	150	30 / 10	3.1/2.6	2.3/1.8	30
2SA1478/2SC3788	TO-220		200	200	0.1	1.3	150	30 / 10	2.6/1.7	1.7/1.2	30
2SA1479/2SC3789		TO-220	300	300	0.1	1.5	70	30 / 10	3.1/2.6	2.3/1.8	30
2SA1480/2SC3790	TO-220		300	300	0.1	1.5	150	30 / 10	3.1/2.6	2.3/1.8	30
2SC4217		TO-220	300	300	0.2	1.5	70	10 / 10	3.5	-	50
2SC4378	TO-220		300	300	0.2	1.5	100	30 / 10	3.9	3.2	30
2SC4188		TO-220	200	200	0.1	*10	150	30 / 10	1.8	1.3	30

Underlined type Nos. are before mass production.

*Classification by h_{FE}

40	C	80	60	D	120	100	E	200	160	F	320
(CP type)											
60		3	120	90	4	180	135	5	270		

2SC5291(100~400)

100	R	200	140	S	280	200	T	400
-----	---	-----	-----	---	-----	-----	---	-----

*Equivalent Circuit for Video Output Use

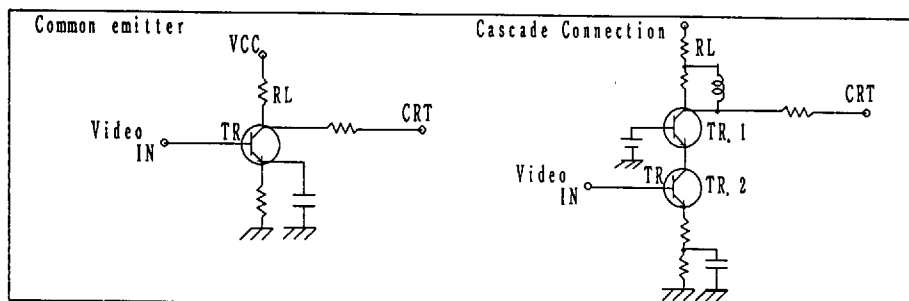

SANYO:TO-220ML 1:B, 2:C, 3:E

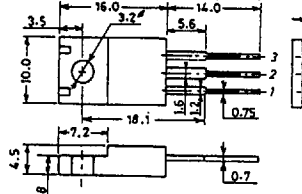

SANYO:TO-220

1:Base, 2:Collector, 3:Emitter

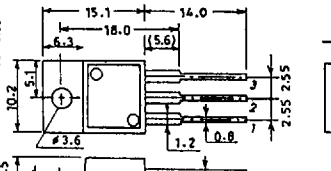

SANYO:TO-126

1:E, 2:C, 3:B

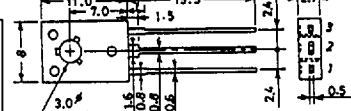

SANYO:TO-126ML

1:E, 2:C, 3:B

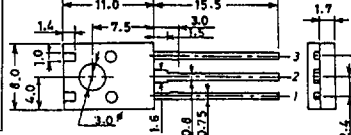

SANYO:TO-220ML 1:B, 2:C, 3:E

These specifications are subject to change without notice.

SANYO Discrete Device Package Outlines (unit:mm)

Small-Signal Transistors

Outlines name SSFP, SMCP, MCP, MCP4/6, CP, CP4/5/6, CPH3/5/6, PCP, PCP4/5, XP5/6, TP, TP-FA, MFP6, TSSOP8, SOP8, SPA, NP, MP, NMP, FLP, TO-126, TO-126ML, TO-126LP

Large-Signal Transistors

ZP, SMP, SMP-FD, TO-220, TO-220C1, TO-220ML, TO-220FI (LS), TO-220MF, TO-3PB, TO-3PML, TO-3PBL, TO-3JML

SANYO Transistor Package Name List.

Surface Mount Types

SSFP Super Small Flat Package
 SMCP Super Mini Chip Pack.
 MCP Mini Chip Pack.
 MCP4/6 Mini Chip Pack. (FH type)
 CP Chip Pack.
 CP5/6 Chip Pack. (FC type)
 CPH3/5/6 * Chip Pack high-power
 PCP Power Chip Pack.
 PCP4/5 Power Chip Pack. (FP type)
 XP (FX type)
 TSSOP8 (FTS, FTD type)
 SOP8 (FW, FSS type)
 TP-FA Tiny Package
 SMP-FD For large signal
 ZP For large signal

Lead Types

NMP New MP
 FLP Full Mold Large Package
 TO-126LP Large-Power
 TO-126ML Micaless
 TO-220, 220ML ML:Micaless type
 TO-220C1 CI:Compact Isolation
 TO-220FI (LS) Full Isolation (leade short type)
 TO-220MF Mini Fin Short fin type.
 TO-3PB, 3PML Bushless, ML:Micaless
 TO-3PML Micaless
 TO-3PBL Bushless Large
 TO-3JML Jumbo Micaless

PB, BL:no insulating needed.

Notes

Nomenclature of house NOS.
 The first several letters of the type Nos. of the FSS, FTD, FW, FTS, FC, FP, FH, series mean:

- 1'st F : Packages for complex type devices. (CP5/6, MCP4/6, PCP4/5, XP5/6, SOP8, TSSOP8)
- 2'nd S: SOP8 package
- 2'nd W: Double chips
- 2'nd T: TSSOP8 package
- 2'nd C: CP5/6 package
- 2'nd P: PCP4/5 package
- 2'nd X: XP5/6 package
- 2'nd D: Dual type
- 2'nd H: Ultra high freq. type
- 3'rd S: Single

Type Nos. of 1XX or 1XXX are p-channel types.
 Type Nos. of 2XX or 2XXX are N-channel types.
 XP package is excluded.

*:How to name CPH3/6 devices. Package name followed by 1, 2, 3 or 4 and then tow-digit consecutive Nos. Figures following the package names mean: 1:PNP Tr, 2:NPN Tr, 3:P-ch MOSFET, 4:N-ch MOSFET.

Surface Mount Type Outlines (JEDEC and EIAJ name are in parentheses.)

Top View Pin Nos. of top view are CAD register Nos. Bottom side : Heat sink side.

SANYO:SSFP Device weight:0.002g SANYO:SMCP(SC-75A) Device weight:0.003g SANYO:MCP(SC-70), MCP4(SC-82, A), MCP6 Device weight:0.006g, 0.007g, 0.007g

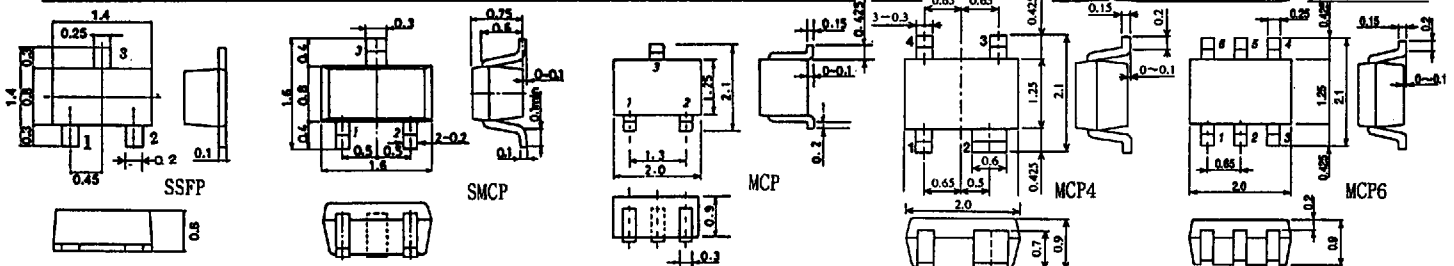

SANYO:CP(SC-59, TO-236) Device weight:0.013g SANYO:CP4, CP5, CP6(SC-61, SC-74A, SC-74, SOT143) Device weight:0.013g, 0.014g, 0.015g SANYO:CPH3, CPH5 Device weight:0.013g, 0.015g

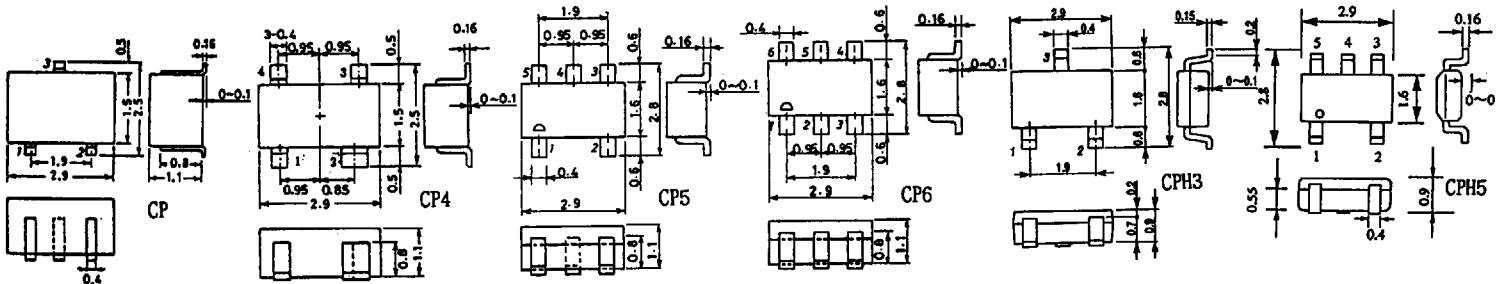

SANYO:CPH6 Device weight:0.015g SANYO:PCP, PCP4/5(SC-62, SOT89) Bottom View Device weight:0.058g, 0.052g SANYO:XP5 Bottom View Device weight:0.062g

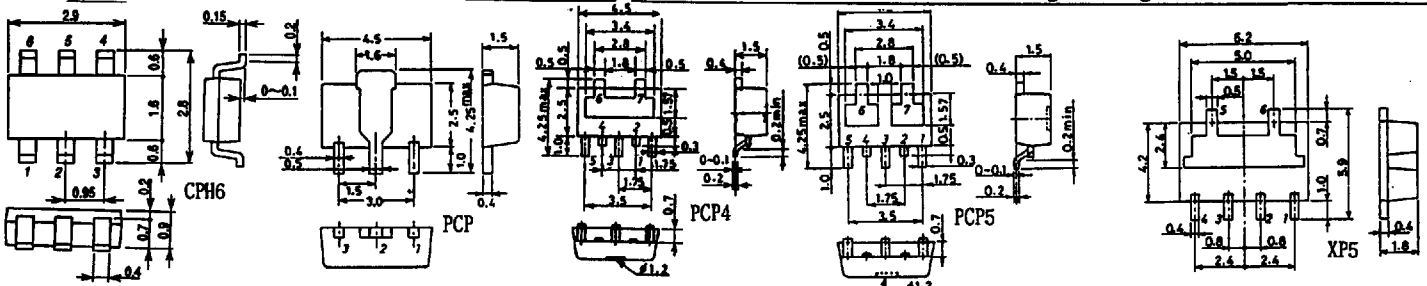

SANYO:XP6 Bottom View Device weight:0.062g SANYO:MFP6 Device weight:0.089g SANYO:SOP8 Device weight:0.093g SANYO:TSSOP8 Device weight:0.04g

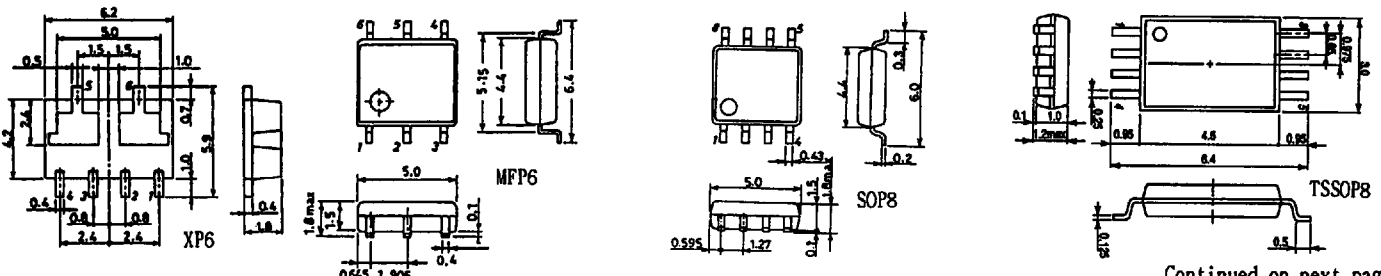

Continued on next page

SANYO Discrete Device Package Outlines (unit:mm)

Surface Mount Type Outlines (JEDEC and EIAJ name are in parentheses.)
 Top View Pin Nos. of top view are CAD register Nos. Bottom side: Heat sink side.

SANYO:TP, TP-FA(SC-64, SC-63, TO-251)
 Device weight:0.315g, 0.282g

SANYO:SMP, SMP-FD(forming type)(SC-83)
 Device weight:1.4g

SANYO:ZP
 Device weight:0.62g

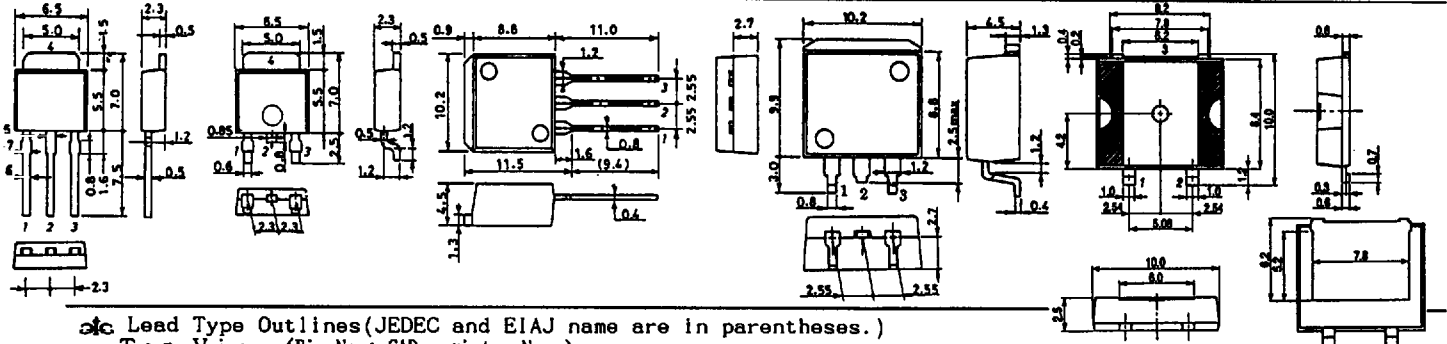

Lead Type Outlines (JEDEC and EIAJ name are in parentheses.)
 Top View (Pin No.: CAD register Nos.)

SANYO:SPA(TO-18, TO-39)
 Device weight:0.098g

SANYO:NP(SC-43A, TO-92, SOT-54)
 Device weight:0.269g

SANYO:MP(SC-51, TO-226)
 Device weight:0.578g

SANYO:NMP(SC-71)
 Device weight:0.21g, AN use:0.275g

SANYO:FLP
 Device weight:1.1g

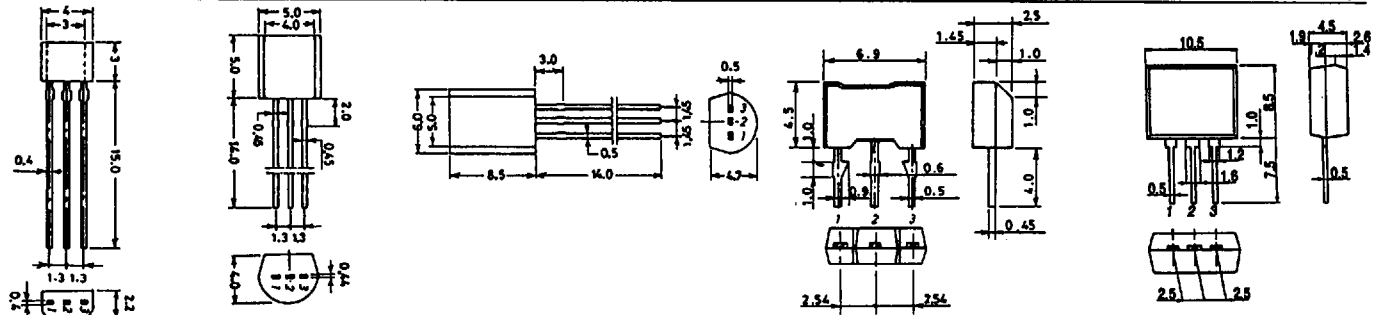

SANYO:TO-126(TO-126, TO-225, SOT-32), TO-126LP, TO-126ML(SOT-82)
 Device weight:0.675g, 0.7g, 0.97g

SANYO:TO-220AB, AB(SC-45, 46, TO-220AA)
 Device weight:1.9g

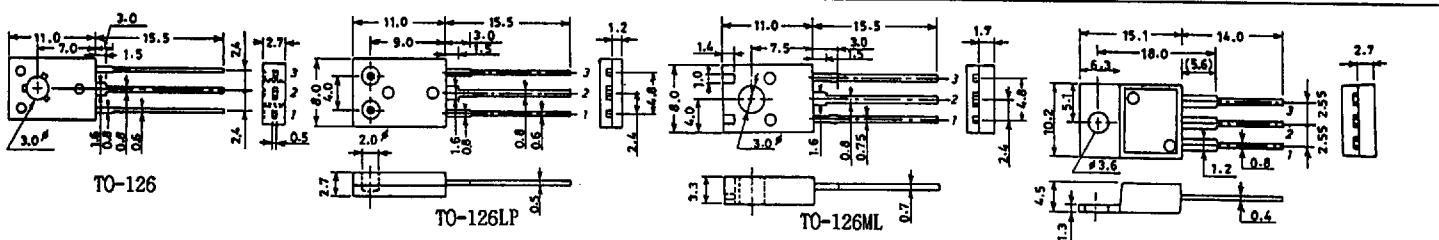

SANYO:TO-220CI
 Device weight:1.75g

SANYO:TO-220ML(SC-67, SOT-186)
 Device weight:1.9g

SANYO:TO-220FI(LS)(SC-67, SOT-189)
 Device weight:1.8g

SANYO:TO-220MF
 Device weight:1.4g

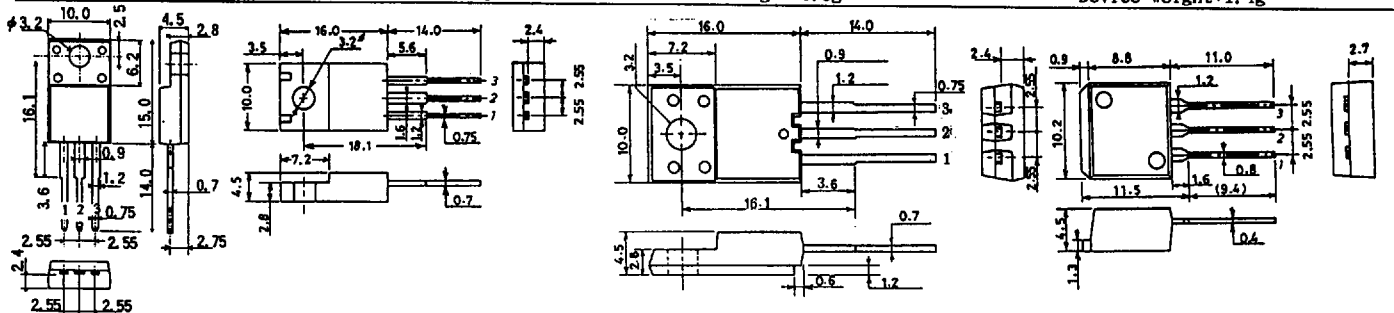

SANYO:TO-3PB(SC-65, TO-218)
 Device weight:5.8g

SANYO:TO-3PML(1SOWATT218)
 Device weight:5.3g

SANYO:TO-3PBL(TO-247)
 Device weight:9.2g

SANYO:TO-3JML
 Device weight:9.2g

