

**Features**

- -3 dB bandwidth = 120 MHz,  $A_V = 1$
- -3 dB bandwidth = 110 MHz,  $A_V = 2$
- 0.01% differential gain and 0.01° differential phase (NTSC, PAL)
- 0.05% differential gain and 0.02° differential phase (HDTV)
- Slew rate 2000 V/ $\mu$ s
- 65 mA output current
- Drives  $\pm 10V$  into 200 $\Omega$  load
- Characterized at  $\pm 5V$  and  $\pm 15V$
- Low voltage noise
- Current mode feedback
- Settling time of 40 ns to 0.25% for a 10V step
- Output short circuit protected
- Low cost

**Applications**

- Video gain block
- Video distribution amplifier
- HDTV amplifier
- Residue amplifiers in ADC
- Current to voltage converter
- Coax cable driver

**Ordering Information**

Part No.	Temp. Range	Package	Outline #
EL2030CN	-40°C to +85°C	8-Pin P-DIP	MDP0031
EL2030CM	-40°C to +85°C	20-Lead SOL	MDP0027

**General Description**

The EL2030 is a very fast, wide bandwidth amplifier optimized for gains between -10 and +10. Built using the Elantec monolithic Complementary Bipolar process, this amplifier uses current mode feedback to achieve more bandwidth at a given gain than a conventional voltage feedback operational amplifier.

Due to its wide operating supply range ( $\pm 15V$ ) and extremely high slew rate of 2000 V/ $\mu$ s, the EL2030 drives  $\pm 10V$  into 200 $\Omega$  at a frequency of 30 MHz, while achieving 110 MHz of small signal bandwidth at  $A_V = +2$ . This bandwidth is still 95 MHz for a gain of +10. On  $\pm 5V$  supplies the amplifier maintains a 90 MHz bandwidth for  $A_V = +2$ . When used as a unity gain buffer, the EL2030 has a 120 MHz bandwidth with the gain precision and low distortion of closed loop buffers.

The EL2030 features extremely low differential gain and phase, a low noise topology that reduces noise by a factor of 2 over competing amplifiers, and settling time of 40 ns to 0.25% for a 10V step. The output is short circuit protected. In addition, datasheet limits are guaranteed for  $\pm 5V$  and  $\pm 15V$  supplies.

Elantec's products and facilities comply with applicable quality specifications. See Elantec document, QRA-1: *Processing, Monolithic Integrated Circuits*.

**Connection Diagrams**

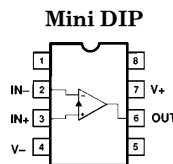

Top View

2030-1

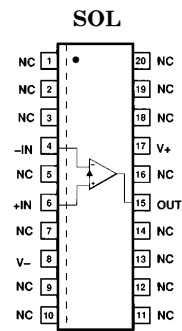

Top View

2030-3

Note: Non-designated pins are no connects and are not electrically connected internally.

Manufactured under U.S. Patent No. 4,893,091.

Note: All information contained in this data sheet has been carefully checked and is believed to be accurate as of the date of publication; however, this data sheet cannot be a "controlled document". Current revisions, if any, to these specifications are maintained at the factory and are available upon your request. We recommend checking the revision level before finalization of your design documentation.

# EL2030C

## 120 MHz Current Feedback Amplifier

### Absolute Maximum Ratings (T<sub>A</sub> = 25°C)

V <sub>S</sub>	Supply Voltage	±18V or 36V	T <sub>A</sub>	Operating Temperature Range	−40°C to +85°C
V <sub>IN</sub>	Input Voltage	±15V or V <sub>S</sub>	T <sub>J</sub>	Operating Junction Temperature	
ΔV <sub>IN</sub>	Differential Input Voltage	±6V		Plastic Packages	150°C
P <sub>D</sub>	Maximum Power Dissipation	See Curves	T <sub>ST</sub>	Storage Temperature	−65°C to +150°C
I <sub>IN</sub>	Input Current	±10 mA			
I <sub>OP</sub>	Peak Output Current	Short Circuit Protected			
	Output Short Circuit Duration	Continuous			
	(Note 1)				

### Important Note:

All parameters having Min/Max specifications are guaranteed. The Test Level column indicates the specific device testing actually performed during production and Quality inspection. Elantec performs most electrical tests using modern high-speed automatic test equipment, specifically the LTX77 Series system. Unless otherwise noted, all tests are pulsed tests, therefore T<sub>J</sub> = T<sub>C</sub> = T<sub>A</sub>.

Test Level	Test Procedure
I	100% production tested and QA sample tested per QA test plan QCX0002.
II	100% production tested at T <sub>A</sub> = 25°C and QA sample tested at T <sub>A</sub> = 25°C, T <sub>MAX</sub> and T <sub>MIN</sub> per QA test plan QCX0002.
III	QA sample tested per QA test plan QCX0002.
IV	Parameter is guaranteed (but not tested) by Design and Characterization Data.
V	Parameter is typical value at T <sub>A</sub> = 25°C for information purposes only.

### Open Loop DC Electrical Characteristics V<sub>S</sub> = ±15V, R<sub>L</sub> = 200Ω, unless otherwise specified

Parameter	Description	Condition	Temp	Min	Typ	Max	Test Level	Units
							EL2030C	
V <sub>OS</sub>	Input Offset Voltage	V <sub>S</sub> = ±15V	25°C		10	20	I	mV
			T <sub>MIN</sub> , T <sub>MAX</sub>			30	III	mV
		V <sub>S</sub> = ±5V	25°C		5	10	I	mV
			T <sub>MIN</sub> , T <sub>MAX</sub>			15	III	mV
ΔV <sub>OS</sub> /ΔT	Offset Voltage Drift			25		V	μV/°C	
+I <sub>IN</sub>	+ Input Current	V <sub>S</sub> = ±5V, ±15V	25°C		5	15	I	μA
			T <sub>MIN</sub> , T <sub>MAX</sub>			25	III	μA
−I <sub>IN</sub>	− Input Current	V <sub>S</sub> = ±5V, ±15V	25°C		10	40	I	μA
			T <sub>MIN</sub> , T <sub>MAX</sub>			50	III	μA
+R <sub>IN</sub>	+ Input Resistance		Full	1.1	2.0		II	MΩ
C <sub>IN</sub>	Input Capacitance		25°C		1		V	pF
CMRR	Common Mode Rejection Ratio (Note 2)	V <sub>S</sub> = ±5V, ±15V	Full	50	60		II	dB
−ICMR	Input Current Common Mode Rejection (Note 2)		25°C		5	10	I	μA/V
			T <sub>MIN</sub> , T <sub>MAX</sub>			20	III	μA/V
PSRR	Power Supply Rejection Ratio (Note 3)		Full	60	70		II	dB
+IPSR	+ Input Current Power Supply Rejection (Note 3)		25°C		0.1	0.5	II	μA/V
			T <sub>MIN</sub> , T <sub>MAX</sub>			1.0	III	μA/V
−IPSR	− Input Current Power Supply Rejection (Note 3)		25°C		0.5	5.0	II	μA/V
			T <sub>MIN</sub> , T <sub>MAX</sub>			8.0	III	μA/V

# EL2030C

## 120 MHz Current Feedback Amplifier

### Open Loop DC Electrical Characteristics

$V_S = \pm 15V$ ,  $R_L = 200\Omega$ , unless otherwise specified — Contd.

Parameter	Description	Condition	Temp	Min	Typ	Max	Test Level	Units
							EL2030C	
$R_{OL}$	Transimpedance ( $\Delta V_{OUT}/\Delta(-I_{IN})$ ) $V_{OUT} = \pm 10V$	$V_S = \pm 15V$	25°C	88	150		II	V/mA
			$T_{MIN}, T_{MAX}$	75			III	V/mA
	$V_{OUT} = \pm 2.5V$ (Note 6)	$V_S = \pm 5V$	25°C	80	120		II	V/mA
			$T_{MIN}, T_{MAX}$		70		III	V/mA
$A_{VOL}$	Open Loop DC Voltage Gain $V_{OUT} = \pm 10V$	$V_S = \pm 15V$	Full	60	70		II	dB
	$V_{OUT} = \pm 2.5V$ (Note 6)	$V_S = \pm 5V$	Full	56	65		II	dB
$V_O$	Output Voltage Swing (Note 6)	$V_S = \pm 15V$	Full	12	13		II	V
		$V_S = \pm 5V$	Full	3	3.5		II	V
$I_{OUT}$	Output Current (Note 9)	$V_S = \pm 15V$	Full	60	65		II	mA
		$V_S = \pm 5V$	Full	30	35		II	mA
$R_{OUT}$	Output Resistance		25°C		5		V	$\Omega$
$I_S$	Quiescent Supply Current		Full		15	21	II	mA
$I_{SC}$	Short Circuit Current		25°C		85		V	mA

### Closed Loop AC Electrical Characteristics

$V_S = \pm 15V$ ,  $A_V = +2$ ,  $R_F = 820\Omega$ ,  $R_G = 820\Omega$  and  $R_L = 200\Omega$

Parameter	Description	Condition	Temp	Min	Typ	Max	Test Level	Units
							EL2030C	
SR	Slew Rate (Note 7)		25°C	1200	2000		IV	V/ $\mu$ s
FPBW	Full Power Bandwidth (Note 4)		25°C	19	31.8		IV	MHz
$t_r, t_f$	Rise Time, Fall Time	$V_{pp} = 250$ mV	25°C		3		V	ns
$t_s$	Settling Time to 0.25% for 10V step (Note 5)		25°C		40		V	ns
$\Delta G$	Differential Gain (Note 8)		25°C		0.01		V	% p-p
$\Delta\phi$	Differential Phase (Note 8)		25°C		0.01		V	° p-p
eN	Input Spot Noise at 1 kHz $R_G = 101$ ; $R_F = 909$		25°C		4		V	nV/ $\sqrt{Hz}$

Note 1: A heat sink is required to keep the junction temperature below absolute maximum when the output is shorted.

Note 2:  $V_{CM} = \pm 10V$  for  $V_S = \pm 15V$ . For  $V_S = \pm 5V$ ,  $V_{CM} = \pm 2.5V$ .

Note 3:  $V_{OS}$  is measured at  $V_S = \pm 4.5V$  and at  $V_S = \pm 18V$ . Both supplies are changed simultaneously.

Note 4: Full Power Bandwidth is specified based on Slew Rate measurement  $FPBW = SR/2\pi V_P$ .

Note 5: Settling Time measurement techniques are shown in: "Take The Guesswork Out of Settling Time Measurements", EDN, September 19, 1985. Available from the factory upon request.

Note 6:  $R_L = 100\Omega$ .

Note 7:  $V_O = \pm 10V$ , tested at  $V_O = \pm 5$ . See test circuit.

Note 8: NTSC (3.58 MHz) and PAL (4.43 MHz).

Note 9: For  $V_S = \pm 15V$ ,  $V_{OUT} = \pm 10V$ . For  $V_S = \pm 5V$ ,  $V_{OUT} = \pm 2.5V$ .

# EL2030C

## 120 MHz Current Feedback Amplifier

### Typical Performance Curves

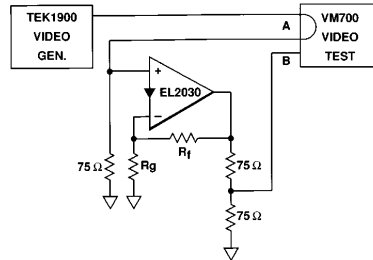

2030-5

Figure 1. NTSC Video Differential Gain and Phase Test Set-Up

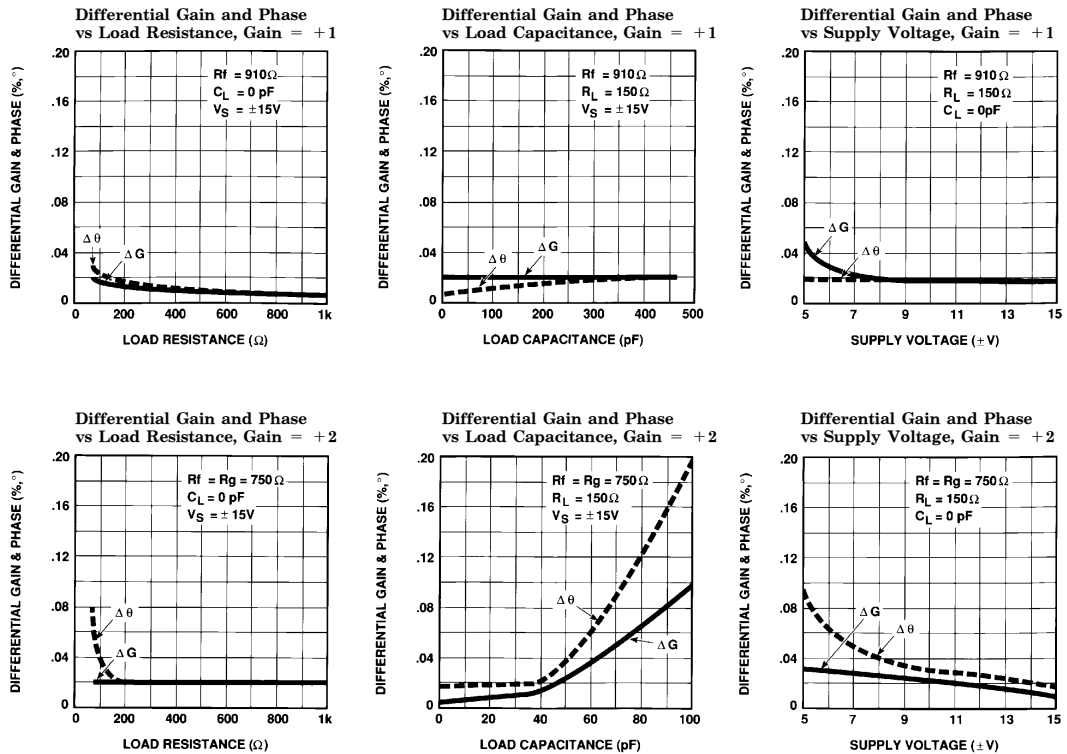

2030-6

# EL2030C

## 120 MHz Current Feedback Amplifier

### Typical Performance Curves — Contd.

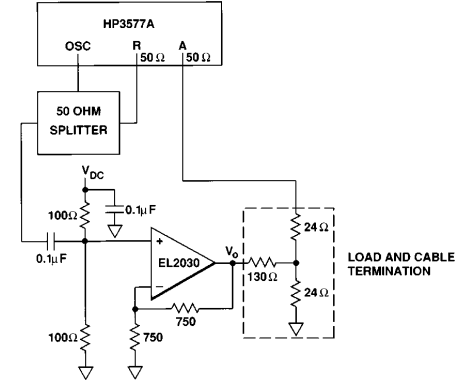

2030-7

Figure 2. HDTV and Wideband Video Differential Gain and Phase Test Set-Up

Differential Gain Error vs Frequency for Various DC Output Levels

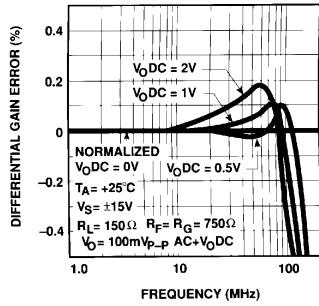

Differential Phase Error vs Frequency for Various DC Output Levels

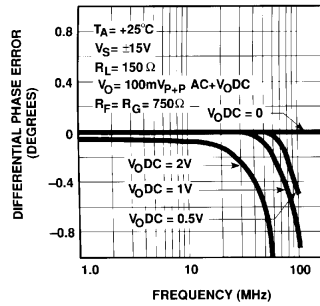

Risetime and Overshoot vs  $R_F$  for  $A_V = +1$

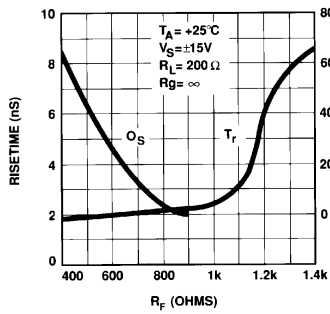

Bandwidth and Peaking vs  $R_F$  for  $A_V = +1$

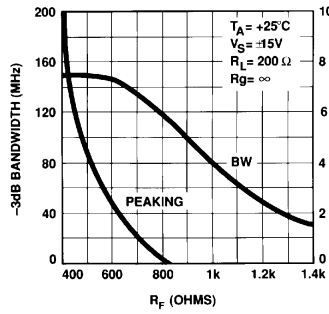

± Slew Rate vs Supply Voltage

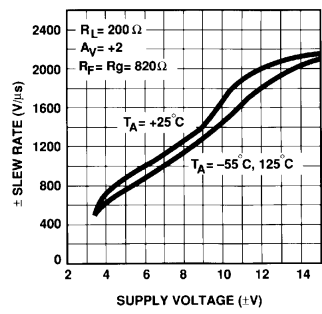

2030-8

# EL2030C

## 120 MHz Current Feedback Amplifier

### Typical Performance Curves — Contd.

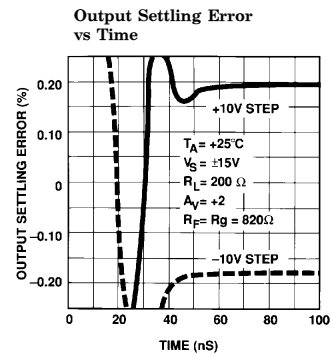
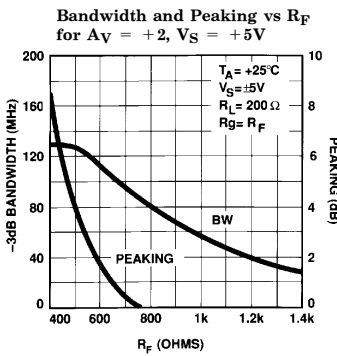
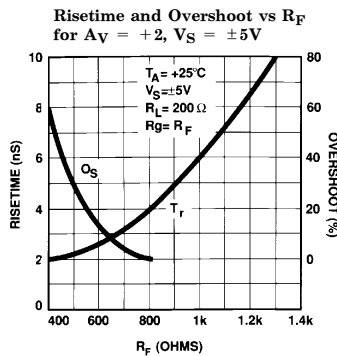
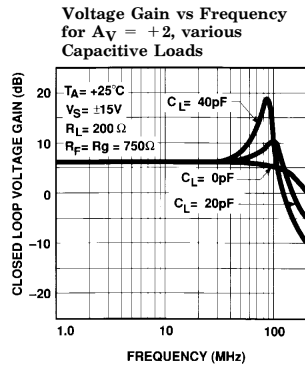
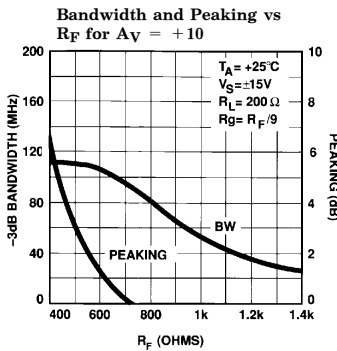
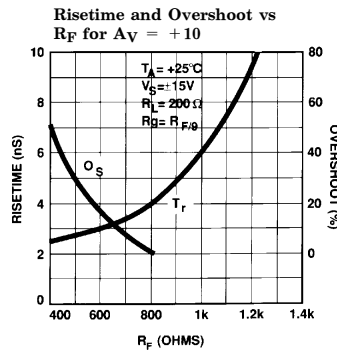
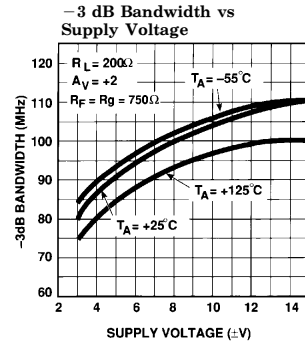
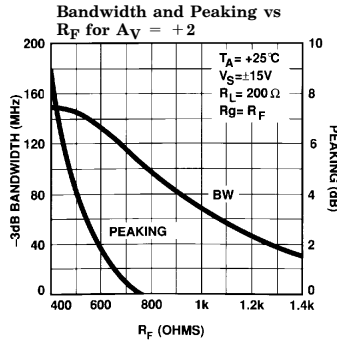
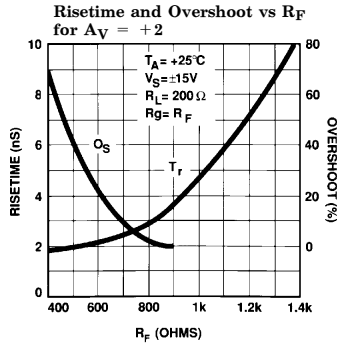

2030-9

# EL2030C

## 120 MHz Current Feedback Amplifier

### Typical Performance Curves — Contd.

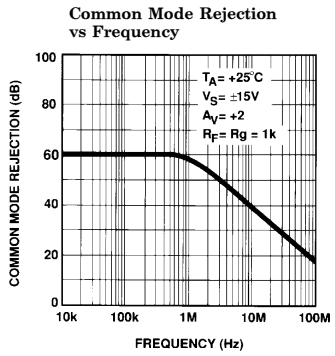
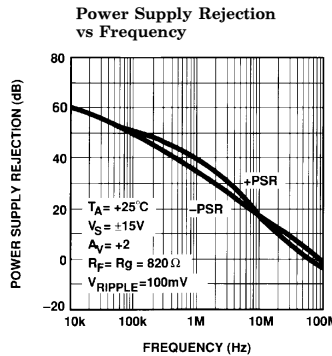
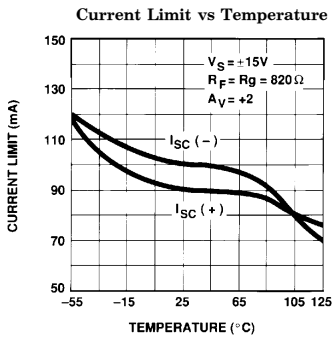
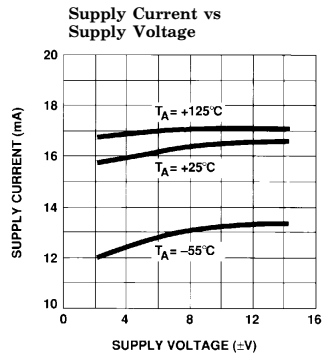
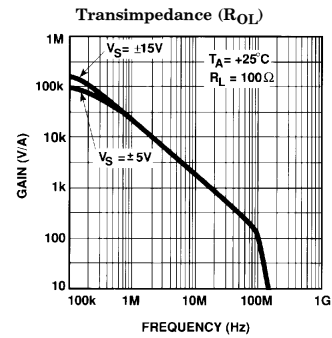
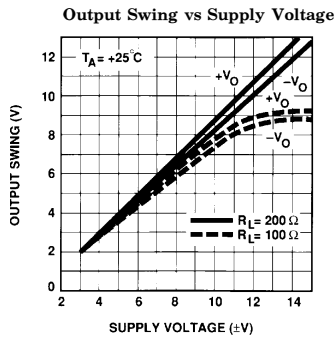
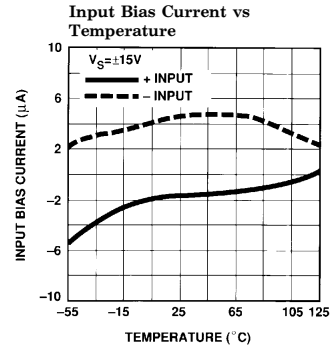
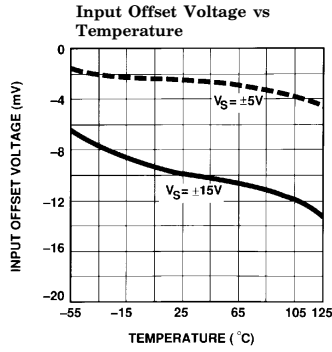
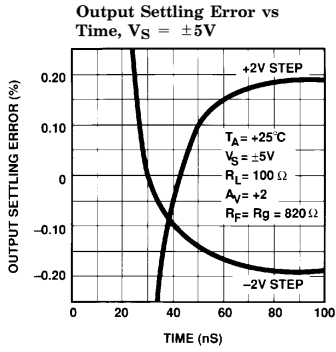

# EL2030C

## 120 MHz Current Feedback Amplifier

### Typical Performance Curves — Contd.

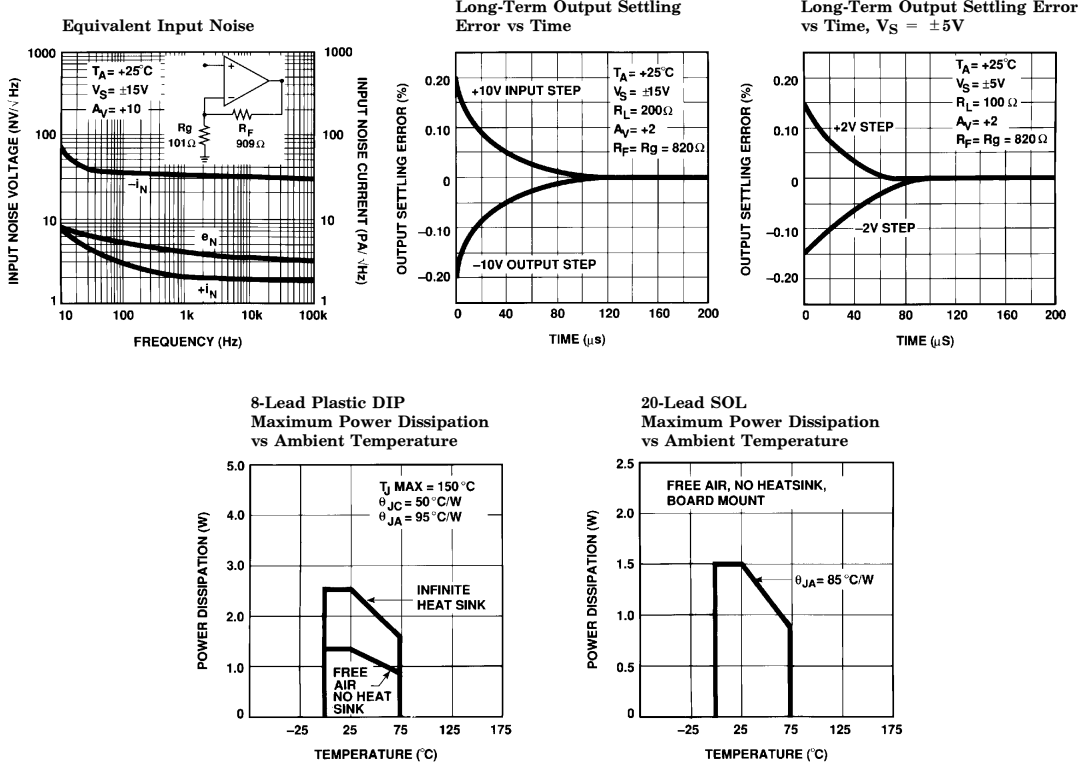

2030-11



# EL2030C

## 120 MHz Current Feedback Amplifier

### Typical Performance Curves — Contd.

**Large Signal Response**

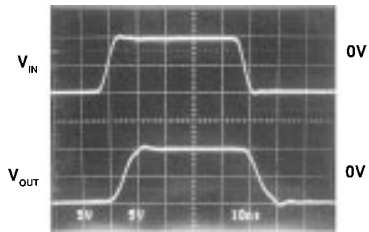

$A_V = +1$ ,  $R_F = 1 \text{ k}\Omega$ ,  
 $R_L = 200\Omega$ ,  $V_S = \pm 15\text{V}$

2030-12

**Large Signal Response**

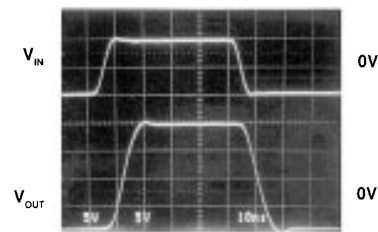

$A_V = +2$ ,  $R_F = R_G = 820\Omega$ ,  
 $R_L = 200\Omega$ ,  $V_S = \pm 15\text{V}$

2030-13

**Large Signal Response**

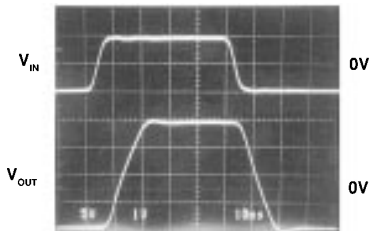

$A_V = +10$ ,  $R_F = 750\Omega$ ,  $R_G = 820\Omega$ ,  
 $R_L = 200\Omega$ ,  $V_S = \pm 15\text{V}$

2030-14

**Large Signal Response**

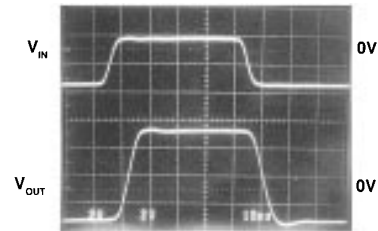

$A_V = +2$ ,  $R_F = R_G = 750\Omega$ ,  
 $R_L = 200\Omega$ ,  $V_S = \pm 15\text{V}$

2030-15

### Burn-In Circuit

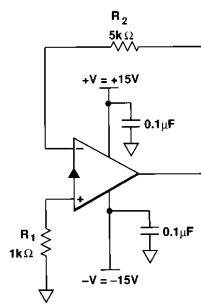

2030-16

ALL PACKAGES USE THE SAME SCHEMATIC.

### Test Circuit

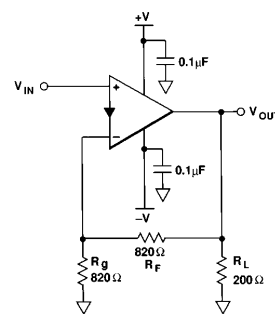

2030-17

# ***EL2030C***

## ***120 MHz Current Feedback Amplifier***

### **Application Information**

#### **Product Description**

The EL2030 is a current mode feedback amplifier similar to the industry standard EL2020, but with greatly improved AC characteristics. Most significant among these are the extremely wide bandwidth and very low differential gain and phase. In addition, the EL2030 is fully characterized and tested at  $\pm 5V$  and  $\pm 15V$  supplies.

#### **Power Supply Bypassing/Lead Dressing**

It is important to bypass the power supplies of the EL2030 with  $0.1 \mu F$  ceramic disc capacitors. Although the lead length is not critical, it should not be more than  $\frac{1}{2}$  inch from the IC pins. Failure to do this will result in oscillation, and possible destruction of the part. Another important detail is the lead length of the inputs. The inputs should be designed with minimum stray capacitance and short lead lengths to avoid ringing and distortion.

#### **Latch Mode**

The EL2030 can be damaged in certain circumstances resulting in catastrophic failure in which destructive supply currents flow in the device. Specifically, an input signal greater than  $\pm 5$  volts at currents greater than 5 mA is applied to the device when the power supply voltages are zero will result in failure of the device.

In addition, the EL2030 will be destroyed or damaged in the same way for momentary power supply voltage reversals. This could happen, for example, during a power turn on transient, or if the power supply voltages were oscillating and the positive rail were instantaneously negative with respect to the negative rail or vice versa.

#### **Differential Gain and Differential Phase**

Composite video signals contain intensity, color, hue, timing and audio information in AM, FM, and Phase Modulation. These video signals pass through many stages during their production, processing, archiving and transmission. It is important that each stage not corrupt these signals to provide a "high fidelity" image to the end viewer.

An industry standard way of measuring the distortion of a video component (or system) is to measure the amount of differential gain and phase error it introduces. A 100 mV peak to peak sine wave at 3.58 MHz for NTSC (4.3 MHz for PAL), with 0V DC component serves as the reference. The reference signal is added to a DC offset, shifting the sine wave from 0V to 0.7V which is then applied to the device under test (DUT). The output signal from the DUT is compared to the reference signal. The Differential Gain is a measure of the change in amplitude of the sine wave and is measured in percent. The Differential Phase is a measure of the change in the phase of the sine wave and is measured in degrees. Typically, the maximum positive and negative deviations are summed to give peak differential gain and differential phase errors. The test setup in Figure 1 was used to characterize the EL2030. For higher than NTSC and PAL frequencies, an alternate Differential Gain and Phase measurement can be made using an HP3577A Network Analyser and the setup shown in Figure 2. The frequency response is normalized to gain or phase with 0V DC at the input. From the normalized value a DC offset voltage is introduced and the Differential Gain or Phase is the deviation from the normalized value.

#### **Video Applications**

The video signals that must be transmitted for modest distances are usually amplified by a device such as the EL2030 and carried via coax cable. There are at least two ways to drive cables, single terminated and double terminated.

When driving a cable, it is important to terminate it properly to avoid unwanted signal reflections. Single termination ( $75\Omega$  to ground at receive end) may be sufficient for less demanding applications. In general, a double terminated cable ( $75\Omega$  in series at drive end and  $75\Omega$  to ground at receive end) is preferred since the impedance match at both ends of the line will absorb signal reflections. However, when double termination is used (a total impedance of  $150\Omega$ ), the received signal is reduced by half; therefore, the amplifier is usually set at a gain of 2 or higher to compensate for attenuation.

# EL2030C

## 120 MHz Current Feedback Amplifier

### Video Applications — Contd.

Video signals are 1V peak-peak in amplitude, from sync tip to peak white. There are 100 IRE (0.714V) of picture (from black to peak white of the transmitted signal) and 40 IRE (0.286V) of sync in a composite video signal (140 IRE = 1V).

For video applications where a gain of two is used (double termination), the output of the video amplifier will be a maximum of 2V peak-peak. With  $\pm 5V$  power supply, the EL2030 output swing of 3.5V is sufficient to satisfy the video output swing requirements. The EL2030 can drive two double terminated coax cables under these conditions. With  $\pm 15V$  supplies, driving four double terminated cables is feasible.

Although the EL2030's video characteristics (differential gain and phase) are impressive with  $\pm 5V$  supplies at NTSC and PAL frequencies, it

can be optimized when the supplies are increased to  $\pm 15V$ , especially at 30 MHz HDTV applications. This is primarily due to a reduction in internal parasitic junction capacitance with increased power supply voltage.

The following table summarizes the behavior of the EL2030 at  $\pm 5V$  and  $\pm 15V$  for NTSC. In addition, 30 MHz HDTV data is included. Refer to the differential gain and phase typical performance curves for more data.

$\pm V_s$	Rload	$A_v$	$\Delta$ Gain	$\Delta$ Phase	Comments
15V	75 $\Omega$	1	0.02%	0.03°	Single terminated
15V	150 $\Omega$	1	0.02%	0.02°	Double terminated
5V	150 $\Omega$	1	0.05%	0.02°	Double terminated
15V	75 $\Omega$	2	0.02%	0.08°	Single terminated
15V	150 $\Omega$	2	0.01%	0.02°	Double terminated
5V	150 $\Omega$	2	0.03%	0.09°	Double terminated
15V	150 $\Omega$	2	0.05%	0.02°	HDTV, Double terminated

### Equivalent Circuit

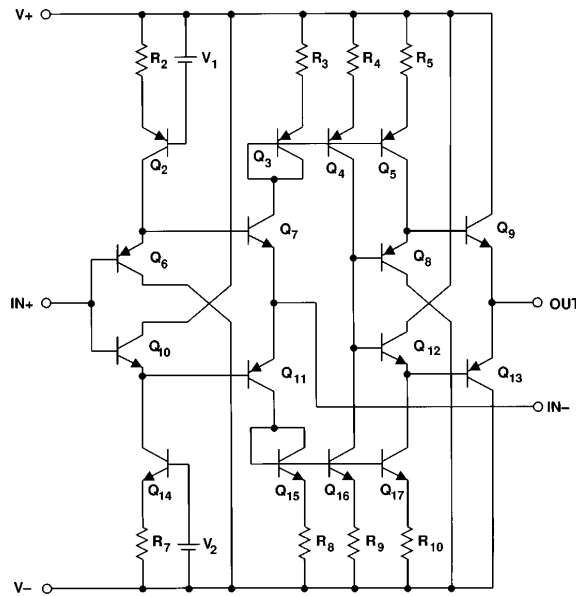

2030-18



# *EL2030C*

## *120 MHz Current Feedback Amplifier*

### **EL2030 Macromodel — Contd.**

```
ios1 7 19 2.5mA
ios2 20 4 2.5mA
*
* Supply Current
*
ips 7 4 9mA
*
* Error Terms
*
ivos 0 23 5mA
vxx 23 0 0V
e4 24 3 1.0
e5 25 0 7 0 1.0
e6 26 0 4 0 1.0
r9 24 23 3K
r10 25 23 1K
r11 26 23 1K
*
* Models
*
.model qn npn (is = 5e-15 bf = 100 tf = 0.1nS)
.model qp pnp (is = 5e-15 bf = 100 tf = 0.1nS)
.model dclamp d(is = 1e-30 ibv = 0.266 bv = 3.7 n = 4)
.ends
```

# EL2030C

## 120 MHz Current Feedback Amplifier

### EL2030 Macromodel — Contd.

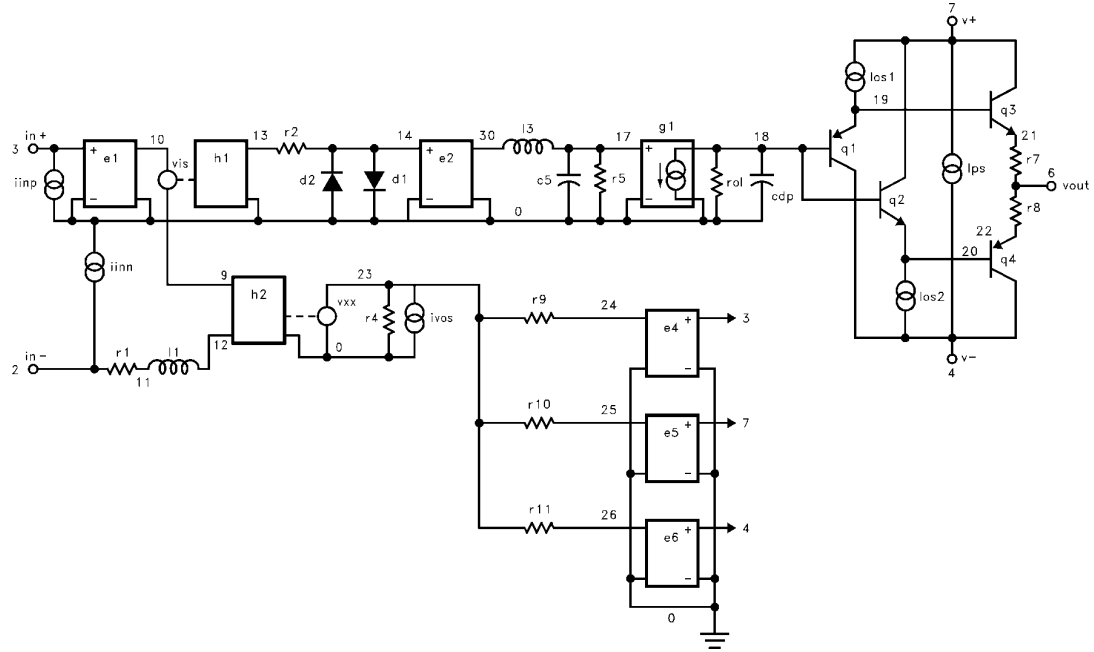

2030-19

**BLANK**

# ***EL2030C***

## ***120 MHz Current Feedback Amplifier***

### **General Disclaimer**

Specifications contained in this data sheet are in effect as of the publication date shown. Elantec, Inc. reserves the right to make changes in the circuitry or specifications contained herein at any time without notice. Elantec, Inc. assumes no responsibility for the use of any circuits described herein and makes no representations that they are free from patent infringement.

***élantec***  
HIGH PERFORMANCE ANALOG INTEGRATED CIRCUITS

### **Elantec, Inc.**

1996 Tarob Court

Milpitas, CA 95035

Telephone: (408) 945-1323

(800) 333-6314

Fax: (408) 945-9305

European Office: 44-71-482-4596

### **WARNING — Life Support Policy**

Elantec, Inc. products are not authorized for and should not be used within Life Support Systems without the specific written consent of Elantec, Inc. Life Support systems are equipment intended to support or sustain life and whose failure to perform when properly used in accordance with instructions provided can be reasonably expected to result in significant personal injury or death. Users contemplating application of Elantec, Inc. products in Life Support Systems are requested to contact Elantec, Inc. factory headquarters to establish suitable terms & conditions for these applications. Elantec, Inc.'s warranty is limited to replacement of defective components and does not cover injury to persons or property or other consequential damages.