

# AVX

A KYOCERA GROUP COMPANY



## AVX Tantalum and Niobium Oxide Capacitors

<Version 2.1>

## SECTION 1: SURFACE MOUNT COMMERCIAL TANTALUM

	<b>Introduction</b> .....	<b>2-4</b>
<b>General</b>	<b>TAJ Series</b> - Standard Tantalum .....	<b>5-8</b>
	<b>TAC Series</b> - Standard TACmicrochip™ .....	<b>9-11</b>
	<b>TLC Series</b> - Tantalum Solid Electrolytic Chip Caps Consumer Series .....	<b>12-13</b>
<b>Low Profile</b>	<b>TAJ Series</b> - Low Profile .....	<b>14-17</b>
	<b>TAC Series</b> - Low Profile TACmicrochip™ .....	<b>18-19</b>
	<b>TAK Series</b> - Low Profile Performance TACmicrochip™ .....	<b>20</b>
<b>Low ESR</b>	<b>TPS Series</b> - Low ESR .....	<b>21-30</b>
	<b>TPS Series III</b> - New Generation Low ESR .....	<b>31-34</b>
	<b>TPM Series</b> - Multianode, Tantalum Ultra Low ESR .....	<b>35-37</b>
	<b>TPC Series</b> - Low ESR TACmicrochip™ .....	<b>38-39</b>
	<b>TCJ Series</b> - Tantalum Solid Electrolytic Chip Caps w/Conductive Polymer Electrode ..	<b>40-41</b>
	<b>TLJ Series</b> - Tantalum Solid Electrolytic Chip Caps Consumer Series .....	<b>41-43</b>
<b>Performance</b>	<b>TRJ Series</b> - Professional Tantalum .....	<b>44-46</b>
	<b>THJ Series</b> - High Temperature (up to 150°C) .....	<b>47-49</b>
<b>High Reliability</b>	<b>TMC Series</b> - Established Reliability TACmicrochip™ .....	<b>50-51</b>
	<b>TAZ Series</b> - CWR09, CWR19, CWR29 and COTS-Plus .....	<b>52-65</b>
	<b>TBJ Series</b> - CWR11 and COTS-Plus .....	<b>66-72</b>
	<b>TBC Series</b> - CWR15 Fixed Chip Capacitors .....	<b>73</b>

## SECTION 2: NIOBIUM OXIDE - OxiCap™

	<b>Niobium Oxide Roadmap</b> .....	<b>74</b>
	<b>NOJ Series</b> - Standard OxiCap™ .....	<b>75-77</b>
	<b>NOJ Series</b> - Low Profile .....	<b>78-79</b>
	<b>NOS Series</b> - Low ESR OxiCap™ .....	<b>80-83</b>
	<b>NOM Series</b> - Low ESR Multianodes .....	<b>84-85</b>

## SECTION 3: LEADED TANTALUM

	<b>Introduction</b> .....	<b>86</b>
	<b>Dipped Radial Capacitors</b> .....	<b>86</b>
	<b>Dipped Radial</b> - TAP Series Wire Form Outline .....	<b>87</b>
	TAP Series .....	<b>88-90</b>
	TAP Series Tape & Reel .....	<b>91-92</b>
	<b>Molded Axial Capacitors</b> - TAR Series .....	<b>93-95</b>
	<b>Hermetic Axial Capacitors</b> - TAA Series .....	<b>96-98</b>
	<b>Axial Capacitors</b> - TAR & TAA Series Tape & Reel .....	<b>99</b>

## SECTION 4: TECHNICAL SUMMARY AND APPLICATION GUIDELINES

	<b>Introduction</b> .....	<b>98-99</b>
	<b>Section 1:</b> Electrical Characteristics and Explanation of Terms .....	<b>100-103</b>
	<b>Section 2:</b> A.C. Operation, Ripple Voltage and Ripple Current .....	<b>104-106</b>
	<b>Section 3:</b> Reliability and Calculation of Failure Rate .....	<b>107-109</b>
	<b>Section 4:</b> Application Guidelines for Tantalum and OxiCap™ Capacitors .....	<b>110-111</b>
	<b>Section 5:</b> Mechanical and Thermal Properties of Capacitors .....	<b>112</b>
	<b>Product Safety and Environmental Information Data</b> .....	<b>113-115</b>
	<b>TAJ, TPS, TRJ, THJ, TPM, TAC, TPC, TLJ, TCJ, TMC Series</b> - Tape & Reel Packaging ..	<b>116-117</b>
	<b>TAZ, CWR09, CWR11, CWR19 Series</b> - Tape & Reel Packaging .....	<b>118</b>
	<b>TAJ, TRJ, THJ, TPS, TPM, NOJ, NOS, NOM, TAC, TPC, TMC, TCJ, TLJ</b> - Marking .....	<b>119</b>

## TAP TECHNICAL SUMMARY AND APPLICATION GUIDELINES

	<b>Section 1:</b> Electrical Characteristics and Explanation of Terms .....	<b>122-125</b>
	<b>Section 2:</b> A.C. Operation, Ripple Voltage and Ripple Current .....	<b>126</b>
	<b>Section 3:</b> Reliability and Calculation of Failure Rate .....	<b>127-129</b>
	<b>Section 4:</b> Application Guidelines for Tantalum Capacitors .....	<b>130</b>
	<b>Questions and Answers</b> .....	<b>131-133</b>

# Section 1: Introduction



## AVX Tantalum

### APPLICATIONS

		
<b>2-16 Volt</b> <b>Low ESR</b> <b>Low Profile Case</b> <b>0603 available</b> <b>Low Failure Rate</b> <b>High Volumetric Efficiency</b> <b>Temperature Stability</b> <b>Stable over Time</b>	<b>50 Volt @ 85°C</b> <b>33 Volt @ 125°C</b> <b>Automotive Range</b> <b>High Reliability</b> <b>Temperature Stability</b> <b>QS9000 Approved</b> <b>TS 16949 Plant Approved</b> <b>Up to 150°C</b> <b>AEC Q200 Approval</b>	<b>2 - 16 Volts</b> <b>Low ESR</b> <b>World's Smallest Tantalum</b> <b>0402 Available</b> <b>High Volumetric Efficiency</b> <b>Low Profile Versions</b>

### QUALITY STATEMENTS

AVX's focus is CUSTOMER satisfaction - customer satisfaction in the broadest sense: product quality, technical support, product availability - all at a competitive price.

In pursuance of the established goals of our corporate wide QV2000 program, it is the stated objective of AVX Tantalum to supply our customers with a world class service in the manufacture and supply of electronic components, while maintaining a positive return on investment.

This world class service shall be defined as consistently supplying product and services of the highest quality and reliability encompassing all aspects of the customer supply chain.

In addition, any new or changed products, processes or services will be qualified to established standards of quality and reliability.

The objectives and guidelines listed above shall be achieved by the following codes of practice:

**1. Continual objective evaluation of customer needs and expectations for the future and the leverage of all AVX resources to meet this challenge.**

**2. Continually fostering and promoting a culture of continuous improvement through ongoing training and empowered participation of employees at all levels of the company.**

**3. Continuous Process Improvement using sound engineering principles to enhance existing equipment, material and processes. This includes the application of the science of S.P.C. focused on improving the Process Capability Index, Cpk.**

The Tantalum division has plants approved to ISO9001:2000 and TS16949:2002 (Automotive Quality System Requirements) with the intention that all facilities world-wide will adopt this as the quality standard.

Dedicated series of tantalum and niobium oxide capacitors meets requirements of AEC-Q200.

The Tantalum division has plants approved to ISO14001 with the intention that all facilities world-wide will adopt this as the quality standard.

# Introduction



## AVX Tantalum

AVX Paignton UK is the Divisional Headquarters for the Tantalum division which has manufacturing locations in Paignton in the UK, Biddeford in Maine, USA, Juarez in Mexico, Lanskrout in the Czech Republic, San Salvador, in El Salvador and Tianjin in P.R. China.

This division manufactures tantalum and niobium oxide capacitors. Tantalum is an element extracted from ores found alongside tin and niobium deposits; the major sources of supply are Canada, Brazil and Australasia.

### TECHNOLOGY TRENDS

The amount of capacitance possible in a tantalum capacitor is directly related to the type of tantalum powder used to manufacture the anode.

The graph following shows how the (capacitance) x (voltage) per gram (CV/g) has steadily increased over time, thus allowing the production of larger and larger capacitances with the same physical volume. CV/g is the measure used to define the volumetric efficiency of a powder, a high CV/g means a higher capacitance from the same volume.

These powder improvements have been achieved through close development with the material suppliers. AVX Tantalum is committed to driving the available technology forward as is clearly demonstrated by extended ratings continually being developed, and new technologies such as TACmicrochip™ and OxiCap™ technology.

If you have any specific requirements, please contact your local AVX sales office for details on how AVX Tantalum can assist you in addressing your future requirements.

### WORKING WITH THE CUSTOMER - ONE STOP SHOPPING

In line with our desire to become the number one supplier in the world for passive and interconnection components, AVX is constantly looking forward and innovating.

It is not good enough to market the best products; the customer must have access to a service system which suits their needs and benefits their business.

The AVX 'one stop shopping' concept is already beneficial in meeting the needs of major OEMs while worldwide partnerships with only the premier division of distributors aids the smaller user.

Helping to market and support our customers across the breadth and depth of our electronic component line card are a dedicated team of sales engineers, applications engineers

Niobium oxide is a ceramic material that can be processed to the same powder form as traditional tantalum capacitors and manufactured in an identical process.

So for high volume tantalum and niobium oxide capacitors with leading edge technology call us first - **AVX your global partner.**

Niobium oxide capacitors have been assigned the OxiCap™ trademark.

Tantalum Powder CV/gm

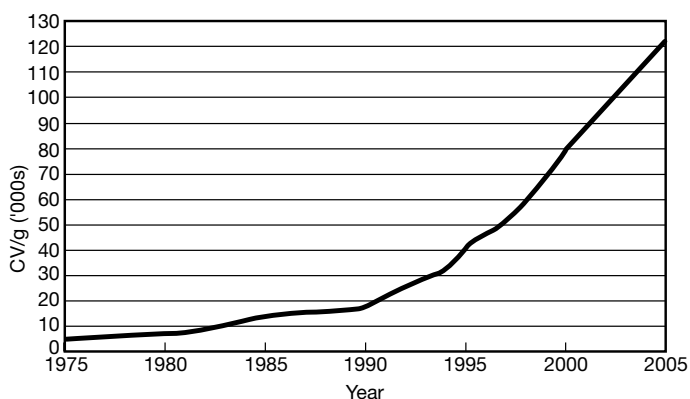

and product marketing managers. Their qualifications are hopefully always appropriate to your commercial needs, but as higher levels of technical expertise are required, access directly to the appropriate department is seamless and transparent.

Total quality starts and finishes with our commitment to customer service. Where cost and quality are perceived as given quantities AVX's first in class service invariably places us in the top rank of any preferred supplier list.

Facilities are equipped with instant worldwide DP and telecommunication links connected to every sales and production site worldwide. That ensures our customers' delivery requirements are consistently met wherever in the world they may be.

\*Niobium Oxide Capacitors are manufactured and sold under patent license from Cabot Corporation, Boyertown, Pennsylvania U.S.A.



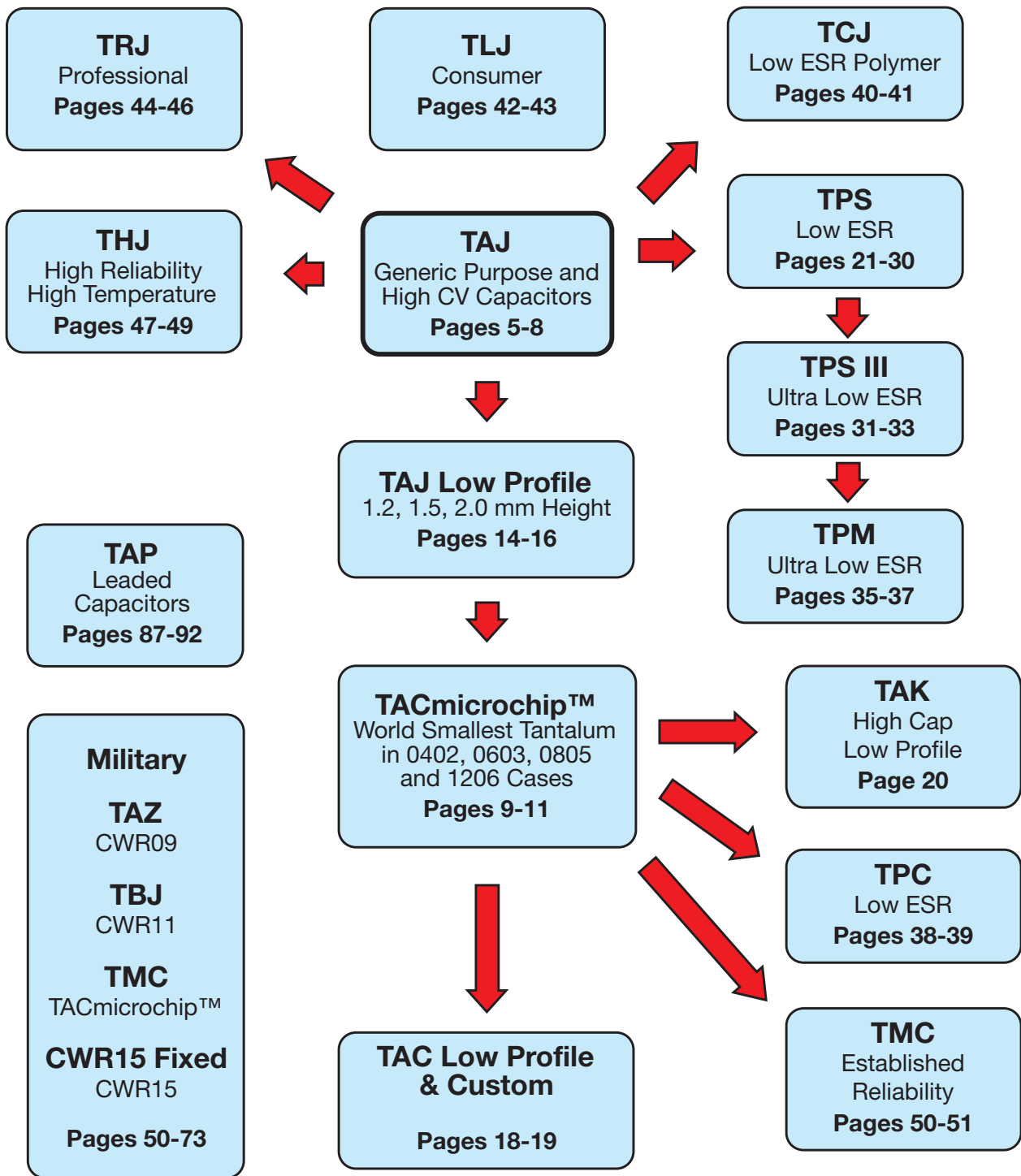

# TAJ Series



## Standard Tantalum



The TAJ standard series encompasses the five key sizes recognized by major OEMs throughout the world. The V case size has been added to the TAJ range to allow high CVs to be offered. The

operational temperature is  $-55^{\circ}\text{C}$  to  $+85^{\circ}\text{C}$  at rated voltage and up to  $+125^{\circ}\text{C}$  with voltage derating in applications utilizing recommended series resistance.

### CASE DIMENSIONS: millimeters (inches)

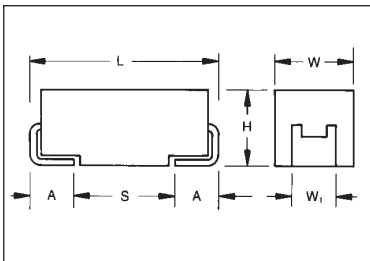

For part marking see page 121

Code	EIA Code	$L \pm 0.20$ (0.008)	$W \pm 0.20$ (0.008) $-0.10$ (0.004)	$H \pm 0.20$ (0.008) $-0.10$ (0.004)	$W_1 \pm 0.20$ (0.008)	$A \pm 0.30$ (0.012) $-0.20$ (0.008)	S Min.
A	3216-18	3.20 (0.126)	1.60 (0.063)	1.60 (0.063)	1.20 (0.047)	0.80 (0.031)	1.10 (0.043)
B	3528-21	3.50 (0.138)	2.80 (0.110)	1.90 (0.075)	2.20 (0.087)	0.80 (0.031)	1.40 (0.055)
C	6032-28	6.00 (0.236)	3.20 (0.126)	2.60 (0.102)	2.20 (0.087)	1.30 (0.051)	2.90 (0.114)
D	7343-31	7.30 (0.287)	4.30 (0.169)	2.90 (0.114)	2.40 (0.094)	1.30 (0.051)	4.40 (0.173)
E	7343-43	7.30 (0.287)	4.30 (0.169)	4.10 (0.162)	2.40 (0.094)	1.30 (0.051)	4.40 (0.173)
V	7361-38	7.30 (0.287)	6.10 (0.240)	$3.45 \pm 0.30$ ( $0.136 \pm 0.012$ )	3.10 (0.120)	1.40 (0.055)	4.40 (0.173)

$W_1$  dimension applies to the termination width for A dimensional area only.

### HOW TO ORDER

**TAJ**

Type

**C**

Case Size  
See table above

**106**

Capacitance Code  
pF code: 1st two digits represent significant figures  
3rd digit represents multiplier (number of zeros to follow)

**M**

Tolerance  
 $K = \pm 10\%$   
 $M = \pm 20\%$

**035**

Rated DC Voltage  
002=2.5Vdc  
004=4Vdc  
006=6.3Vdc  
010=10Vdc  
016=16Vdc  
020=20Vdc  
025=25Vdc  
035=35Vdc  
050=50Vdc

**R**

Packaging  
R = 7" T/R  
(Lead Free since production date 1/1/04)  
S = 13" T/R  
(Lead Free since production date 1/1/04)  
A = Gold Plating  
7" Reel  
B = Gold Plating  
13" Reel

**\*\***

Additional characters may be added for special requirements

### TECHNICAL SPECIFICATIONS

Technical Data:	All technical data relate to an ambient temperature of $+25^{\circ}\text{C}$									
Capacitance Range:	0.1 $\mu\text{F}$ to 1500 $\mu\text{F}$									
Capacitance Tolerance:	$\pm 10\%$ ; $\pm 20\%$									
Rated Voltage ( $V_R$ )	$\leq +85^{\circ}\text{C}$ :	2.5	4	6.3	10	16	20	25	35	50
Category Voltage ( $V_C$ )	$\leq +125^{\circ}\text{C}$ :	1.7	2.7	4	7	10	13	17	23	33
Surge Voltage ( $V_S$ )	$\leq +85^{\circ}\text{C}$ :	3.3	5.2	8	13	20	26	32	46	65
Surge Voltage ( $V_S$ )	$\leq +125^{\circ}\text{C}$ :	2.2	3.4	5	8	13	16	20	28	40
Temperature Range:	$-55^{\circ}\text{C}$ to $+125^{\circ}\text{C}$									
Reliability:	1% per 1000 hours at $85^{\circ}\text{C}$ , $V_R$ with $0.1\Omega/V_R$ series impedance, 60% confidence level									
Qualification:	CECC 30801 - 005 issue 2 EIA 535BAAC									
	Meets requirements of AEC-Q200									



### CAPACITANCE AND RATED VOLTAGE, $V_R$ (VOLTAGE CODE) RANGE (LETTER DENOTES CASE SIZE)

Capacitance		Rated voltage DC ( $V_R$ ) to 85°C								
$\mu\text{F}$	Code	2.5V (e)	4V (G)	6.3V (J)	10V (A)	16V (C)	20V (D)	25V (E)	35V (V)	50V (T)
0.10	104								A	A
0.15	154								A	A/B
0.22	224								A	A/B
0.33	334								A	B
0.47	474							A	A/B	B/C
0.68	684						A	A	A/B	B/C
1.0	105					A	A	A	A/B	B/C
1.5	155				A	A	A	A/B	A/B/C	C/D
2.2	225			A	A	A/B	A/B	A/B	A/B/C	C/D
3.3	335			A	A	A/B	A/B	A/B/C	B/C	C/D
4.7	475		A	A	A/B	A/B	A/B/C	B/C	B/C/D	D
6.8	685		A	A/B	A/B	A/B/C	A/B/C	B/C	C/D	D
10	106		A	A/B	A/B/C	A/B/C	B/C	C/D	C/D/E	D/E
15	156		A/B	A/B	A/B/C	A <sup>(M)</sup> /B/C	B/C/D	C/D	C/D	E
22	226		A	A/B/C	A/B/C	B/C/D	B/C/D	C/D	D/E	V
33	336		A/B	A/B/C	B/C/D	B/C/D	C/D	D/E	D/E/V	
47	476	A	A/B	A/B/C/D	B/C/D	C/D	C/D/E	D/E	D/E	
68	686	A	B/C	B/C/D	B/C/D	C/D	D/E	E/V	V <sup>(M)</sup>	
100	107	B	B/C	B/C/D	B <sup>(M)</sup> /C/D/E	D/E	D/E/V	V		
150	157	B	B/C	C/D	C/D/E	D/E/V	E/V			
220	227	B/D	B <sup>(M)</sup> /C/D	C/D/E	D/E	D/E/V	D/E/V			
330	337	D	C/D/E	C/D/E	D/E/V	E/V	E/V			
470	477	C/D	D/E	D/E/V	E/V	V				
680	687	D/E	D/E	E/V	V					
1000	108	D <sup>(M)</sup> /E	E/V	V <sup>(M)</sup>						
1500	158	E/V	E/V <sup>(M)</sup>							

Non preferred Ratings - not recommended for new designs, higher voltage or smaller case size substitution are offered.

Developmental Ratings - subject to change.

Released codes <sup>(M tolerance only)</sup>

Note: Voltage ratings are minimum values. AVX reserves the right to supply higher ratings in the same case size, to the same reliability standards.

### RATINGS & PART NUMBER REFERENCE

AVX Part No.	Case Size	Capacitance (µF)	Rated Voltage (V)	DCL (µA) Max.	DF % Max.	ESR Max. (Ω) @100kHz
TAJA476*002#	A	47	2.5	0.9	6	3
TAJA686*002#	A	68	2.5	1.4	8	1.5
TAJB107*002#	B	100	2.5	2.5	8	1.4
TAJB157*002#	B	150	2.5	3	10	1.6
TAJB227*002#	B	220	2.5	4.4	16	1.6
TAJD227*002#	D	220	2.5	5.5	8	0.3
TAJD337*002#	D	330	2.5	8.2	8	0.3
TAJC477*002#	C	470	2.5	9.4	12	0.2
TAJD477*002#	D	470	2.5	11.6	8	0.2
TAJD687*002#	D	680	2.5	17	16	0.2
TAJE687*002#	E	680	2.5	17	10	0.2
TAJD108M002#	D	1000	2.5	25	20	0.2
TAJE108*002#	E	1000	2.5	20	14	0.4
TAJE158*002#	E	1500	2.5	37	20	0.2
TAJV158*002#	V	1500	2.5	30	20	0.2
TAJA336*004#	A	33	4	1.3	6	3
TAJA476*004#	A	47	4	1.9	8	2.6
TAJB686*004#	B	68	4	2.7	6	1.8
TAJB107*004#	B	100	4	4	8	0.9
TAJB157*004#	B	150	4	6	8	1.5
TAJC157*004#	C	150	4	6	6	0.3
TAJB227M004#	B	220	4	8.8	12	1.1
TAJC227*004#	C	220	4	8.8	8	1.2
TAJD227*004#	D	220	4	8.8	8	0.9
TAJC337*004#	C	330	4	13.2	8	0.9
TAJD337*004#	D	330	4	13.2	8	0.9
TAJD477*004#	D	470	4	18.8	12	0.9
TAJE477*004#	E	470	4	18.8	10	0.5
TAJD687*004#	D	680	4	27.2	14	0.5
TAJE687*004#	E	680	4	27.2	14	0.9
TAJE108*004#	E	1000	4	40	14	0.4
TAJV108*004#	V	1000	4	40	16	0.4
TAJE158*004#	E	1500	4	60	30	0.2
TAJV158M004#	V	1500	4	60	30	0.2
TAJA106*006#	A	10	6.3	0.6	6	4
TAJA156*006#	A	15	6.3	0.9	6	3.5
TAJA226*006#	A	22	6.3	1.4	6	3
TAJA336*006#	A	33	6.3	2.1	8	2.5
TAJA476*006#	A	47	6.3	2.8	10	1.6
TAJB476*006#	B	47	6.3	3	6	2
TAJC476*006#	C	47	6.3	3	6	1.6
TAJB686*006#	B	68	6.3	4	8	0.9
TAJC686*006#	C	68	6.3	4.3	6	1.5
TAJB107*006#	B	100	6.3	6.3	10	1.7
TAJC107*006#	C	100	6.3	6.3	6	0.9
TAJC157*006#	C	150	6.3	9.5	6	1.3
TAJD157*006#	D	150	6.3	9.5	6	0.9
TAJC227*006#	C	220	6.3	13.9	8	1.2
TAJD227*006#	D	220	6.3	13.9	8	0.9
TAJE227*006#	E	220	6.3	13.9	8	0.9
TAJD337*006#	D	330	6.3	20.8	8	0.4
TAJE337*006#	E	330	6.3	20.8	8	0.4
TAJD477*006#	D	470	6.3	28	12	0.4
TAJE477*006#	E	470	6.3	28	10	0.4
TAJV477*006#	V	470	6.3	28	10	0.4

AVX Part No.	Case Size	Capacitance (µF)	Rated Voltage (V)	DCL (µA) Max.	DF % Max.	ESR Max. (Ω) @100kHz
TAJE687*006#	E	680	6.3	42.8	10	0.5
TAJV687*006#	V	680	6.3	42.8	10	0.5
TAJV108M006#	V	1000	6.3	63	16	0.4
TAJA475*010#	A	4.7	10	0.5	6	5
TAJA685*010#	A	6.8	10	0.7	6	4
TAJA106*010#	A	10	10	1	6	3
TAJA156*010#	A	15	10	1.5	6	3.2
TAJB156*010#	B	15	10	1.5	6	2.8
TAJA226*010#	A	22	10	2.2	8	3
TAJB226*010#	B	22	10	2.2	6	2.4
TAJB336*010#	B	33	10	3.3	6	1.8
TAJC336*010#	C	33	10	3.3	6	1.6
TAJB476*010#	B	47	10	4.7	8	1
TAJC476*010#	C	47	10	4.7	6	1.2
TAJB686*010#	B	68	10	6.8	6	1.4
TAJC686*010#	C	68	10	6.8	6	1.3
TAJB107M010#	B	100	10	10	8	1.4
TAJC107*010#	C	100	10	10	8	1.2
TAJD107*010#	D	100	10	10	6	0.9
TAJC157*010#	C	150	10	15	8	0.9
TAJD157*010#	D	150	10	15	6	0.9
TAJE157*010#	E	150	10	15	8	0.9
TAJD227*010#	D	220	10	22	8	0.5
TAJE227*010#	E	220	10	22	8	0.5
TAJD337*010#	D	330	10	33	8	0.9
TAJE337*010#	E	330	10	33	8	0.9
TAJV337*010#	V	330	10	33	10	0.9
TAJE477*010#	E	470	10	47	10	0.5
TAJV477*010#	V	470	10	47	10	0.5
TAJA225*016#	A	2.2	16	0.5	6	6.5
TAJA335*016#	A	3.3	16	0.5	6	5
TAJB335*016#	B	3.3	16	0.5	6	4.5
TAJA475*016#	A	4.7	16	0.8	6	4
TAJB475*016#	B	4.7	16	0.8	6	3.5
TAJA685*016#	A	6.8	16	1.1	6	3.5
TAJB685*016#	B	6.8	16	1.1	6	2.5
TAJA106*016#	A	10	16	1.6	8	3
TAJB106*016#	B	10	16	1.6	6	2.8
TAJC106*016#	C	10	16	1.6	6	2
TAJA156M016#	A	15	16	2.4	6	2
TAJB156*016#	B	15	16	2.4	6	2.5
TAJC156*016#	C	15	16	2.4	6	1.8
TAJB226*016#	B	22	16	3.5	6	2.3
TAJC226*016#	C	22	16	3.5	6	1.6
TAJD226*016#	D	22	16	3.5	6	1.1
TAJB336*016#	B	33	16	5.3	8	2.1
TAJC336*016#	C	33	16	5.3	6	1.5
TAJD336*016#	D	33	16	5.3	6	0.9
TAJC476*016#	C	47	16	7.5	6	1.4
TAJD476*016#	D	47	16	7.5	6	0.9
TAJC686*016#	C	68	16	10.9	6	1.3
TAJD686*016#	D	68	16	10.9	6	0.9
TAJD107*016#	D	100	16	16	6	0.9
TAJE107*016#	E	100	16	16	6	0.9
TAJD157*016#	D	150	16	24	6	0.9

All technical data relates to an ambient temperature of +25°C. Capacitance and DF are measured at 120Hz, 0.5V RMS with a maximum DC bias of 2.2 volts. DCL is measured at rated voltage after 5 minutes.

\*Insert K for ±10% and M for ±20%

Capacitance Tolerance

# Standard Plating – Insert R for 7" reel and S for 13" reel

# Gold Plating – Insert A for 7" reel and B for 13" reel

**NOTE: AVX reserves the right to supply a higher voltage rating or tighter tolerance part in the same case size, to the same reliability standards.**



### RATINGS & PART NUMBER REFERENCE

AVX Part No.	Case Size	Capacitance (µF)	Rated Voltage (V)	DCL (µA) Max.	DF % Max.	ESR Max. (Ω) @100kHz
TAJE157*016#	E	150	16	24	8	0.3
TAJV157*016#	V	150	16	24	8	0.5
TAJE227*016#	E	220	16	35.2	10	0.5
TAJV227*016#	V	220	16	35.2	8	0.9
TAJA105*020#	A	1	20	0.5	4	9
TAJA155*020#	A	1.5	20	0.5	6	6.5
TAJA225*020#	A	2.2	20	0.5	6	5.3
TAJB225*020#	B	2.2	20	0.5	6	3.5
TAJA335*020#	A	3.3	20	0.7	6	4.5
TAJB335*020#	B	3.3	20	0.7	6	3
TAJA475*020#	A	4.7	20	0.9	6	4
TAJB475*020#	B	4.7	20	0.9	6	3
TAJA685*020#	A	6.8	20	1.4	6	2.5
TAJB685*020#	B	6.8	20	1.4	6	2.5
TAJC685*020#	C	6.8	20	1.4	6	2
TAJB106*020#	B	10	20	2	6	2.1
TAJC106*020#	C	10	20	2	6	1.9
TAJB156*020#	B	15	20	3	6	2
TAJC156*020#	C	15	20	3	6	1.7
TAJB226*020#	B	22	20	4.4	6	1.8
TAJC226*020#	C	22	20	4.4	6	1.6
TAJD226*020#	D	22	20	4.4	6	0.9
TAJC336*020#	C	33	20	6.6	6	1.5
TAJD336*020#	D	33	20	6.6	6	0.9
TAJC476*020#	C	47	20	9.4	6	0.9
TAJD476*020#	D	47	20	9.4	6	0.9
TAJE476*020#	E	47	20	9.4	6	0.9
TAJD686*020#	D	68	20	13.6	6	0.9
TAJE686*020#	E	68	20	13.6	6	0.9
TAJD107*020#	D	100	20	20	6	0.9
TAJE107*020#	E	100	20	20	6	0.9
TAJV107*020#	V	100	20	20	8	0.9
TAJE157*020#	E	150	20	30	8	0.3
TAJV157*020#	V	150	20	30	8	0.5
TAJA474*025#	A	0.47	25	0.5	4	14
TAJA684*025#	A	0.68	25	0.5	4	10
TAJA105*025#	A	1	25	0.5	4	8
TAJA155*025#	A	1.5	25	0.5	6	7.5
TAJB155*025#	B	1.5	25	0.5	6	5
TAJA225*025#	A	2.2	25	0.6	6	7
TAJB225*025#	B	2.2	25	0.6	6	4.5
TAJA335*025#	A	3.3	25	0.8	6	3.7
TAJB335*025#	B	3.3	25	0.8	6	3.5
TAJB475*025#	B	4.7	25	1.2	6	2.8
TAJB685*025#	B	6.8	25	1.7	6	2.8
TAJC685*025#	C	6.8	25	1.7	6	2
TAJC106*025#	C	10	25	2.5	6	1.8
TAJD106*025#	D	10	25	2.5	6	1.2
TAJC156*025#	C	15	25	3.8	6	1.6
TAJD156*025#	D	15	25	3.8	6	1
TAJC226*025#	C	22	25	5.5	6	1.4
TAJD226*025#	D	22	25	5.5	6	0.9
TAJD336*025#	D	33	25	8.3	6	0.9
TAJE336*025#	E	33	25	8.3	6	0.9
TAJD476*025#	D	47	25	11.8	6	0.9
TAJE476*025#	E	47	25	11.8	6	0.9
TAJE686*025#	E	68	25	17	6	0.9
TAJV686*025#	V	68	25	17	6	0.9
TAJV107*025#	V	100	25	25	8	0.4
TAJA104*035#	A	0.1	35	0.5	4	24

AVX Part No.	Case Size	Capacitance (µF)	Rated Voltage (V)	DCL (µA) Max.	DF % Max.	ESR Max. (Ω) @100kHz
TAJA154*035#	A	0.15	35	0.5	4	21
TAJA224*035#	A	0.22	35	0.5	4	18
TAJA334*035#	A	0.33	35	0.5	4	15
TAJA474*035#	A	0.47	35	0.5	4	12
TAJB474*035#	B	0.47	35	0.5	4	10
TAJA684*035#	A	0.68	35	0.5	4	8
TAJB684*035#	B	0.68	35	0.5	4	8
TAJA105*035#	A	1	35	0.5	4	7.5
TAJB105*035#	B	1	35	0.5	4	6.5
TAJA155*035#	A	1.5	35	0.5	6	7.5
TAJB155*035#	B	1.5	35	0.5	6	5.2
TAJC155*035#	C	1.5	35	0.5	6	4.5
TAJB225*035#	B	2.2	35	0.8	6	4.5
TAJB225*035#	B	2.2	35	0.8	6	4.2
TAJC225*035#	C	2.2	35	0.8	6	3.5
TAJB335*035#	B	3.3	35	1.2	6	3.5
TAJC335*035#	C	3.3	35	1.2	6	2.5
TAJB475*035#	B	4.7	35	1.2	6	3.1
TAJC475*035#	C	4.7	35	1.6	6	2.2
TAJD475*035#	D	4.7	35	1.6	6	1.5
TAJC685*035#	C	6.8	35	2.4	6	1.8
TAJD685*035#	D	6.8	35	2.4	6	1.3
TAJC106*035#	C	10	35	3.5	6	1.6
TAJD106*035#	D	10	35	3.5	6	1
TAJE106*035#	E	10	35	3.5	6	0.9
TAJC156*035#	C	15	35	5.3	6	1.4
TAJD156*035#	D	15	35	5.3	6	0.9
TAJD226*035#	D	22	35	7.7	6	0.9
TAJE226*035#	E	22	35	7.7	6	0.9
TAJD336*035#	D	33	35	11.6	6	0.9
TAJE336*035#	E	33	35	11.6	6	0.9
TAJV336*035#	V	33	35	11.6	6	500
TAJE476*035#	E	47	35	16.5	6	0.9
TAJV476*035#	V	47	35	16.5	6	0.4
TAJV686M035#	V	68	35	23.8	6	0.5
TAJA104*050#	A	0.1	50	0.5	4	22
TAJA154*050#	A	0.15	50	0.5	4	15
TAJB154*050#	B	0.15	50	0.5	4	17
TAJA224*050#	A	0.22	50	0.5	4	18
TAJB224*050#	B	0.22	50	0.5	4	14
TAJB334*050#	B	0.33	50	0.5	4	12
TAJB474*050#	B	0.47	50	0.7	4	9.5
TAJC474*050#	C	0.47	50	0.5	4	8
TAJB684*050#	B	0.68	50	0.5	4	8
TAJC684*050#	C	0.68	50	0.5	4	7
TAJB105*050#	B	1	50	0.5	4	7
TAJC105*050#	C	1	50	0.5	4	5.5
TAJC155*050#	C	1.5	50	0.8	6	4.5
TAJD155*050#	D	1.5	50	0.8	6	4
TAJC225*050#	C	2.2	50	1.1	6	3
TAJD225*050#	D	2.2	50	1.1	6	2.5
TAJC335*050#	C	3.3	50	1.7	6	2.5
TAJD335*050#	D	3.3	50	1.7	6	2
TAJD475*050#	D	4.7	50	2.4	6	1.4
TAJD685*050#	D	6.8	50	3.4	6	1
TAJD106*050#	D	10	50	5	6	0.8
TAJE106*050#	E	10	50	5	6	1
TAJE156*050#	E	15	50	7.5	6	0.6
TAJV226*050#	V	22	50	11	8	0.6

All technical data relates to an ambient temperature of +25°C. Capacitance and DF are measured at 120Hz, 0.5V RMS with a maximum DC bias of 2.2 volts. DCL is measured at rated voltage after 5 minutes.

\* Insert K for ±10% and M for ±20% Capacitance Tolerance # **Standard Plating** – Insert R for 7" reel and S for 13" reel # **Gold Plating** – Insert A for 7" reel and B for 13" reel

**NOTE: AVX reserves the right to supply a higher voltage rating or tighter tolerance part in the same case size, to the same reliability standards.**

## Standard Microchip

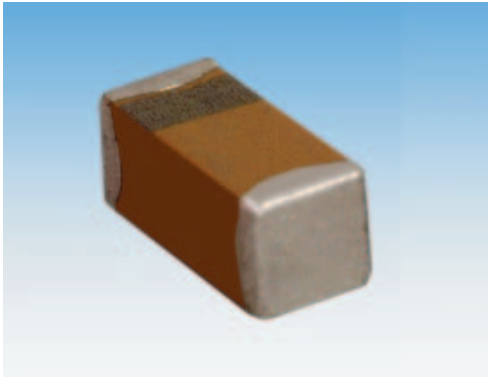

The world's smallest surface mount Tantalum capacitor, small enough to create space providing room for ideas to grow.

TACmicrochip™ is a major breakthrough in miniaturization without reduction in performance.

It offers you the highest energy store in a small case size down to 0402; enhanced high frequency operation through unique ESR performance with temperature and voltage stability is also offered.



LEAD-FREE



HALOGEN-FREE COMPOUNDS

ENVIRONMENTAL FRIENDLY COMPONENT

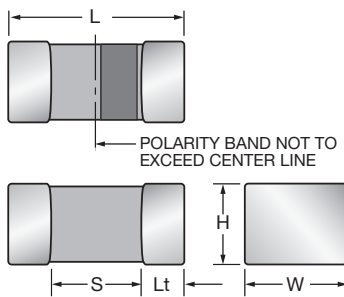

### CASE DIMENSIONS: millimeters (inches)

Code	EIA Code	EIA Metric	Length (L)	Width (W)	Height (H)	Termination Spacing(S)	Minimum Termination Length (Lt)	Average Mass
K	0402	1005-07	1.00 <sup>+0.20</sup> <sub>-0.00</sub> <sup>+0.008</sup> <sub>-0.000</sub> (0.039 -0.000)	0.50 <sup>+0.20</sup> <sub>-0.00</sub> <sup>+0.008</sup> <sub>-0.000</sub> (0.020 -0.000)	0.50 <sup>+0.20</sup> <sub>-0.00</sub> <sup>+0.008</sup> <sub>-0.000</sub> (0.020 -0.000)	0.40 min.	0.10 (0.004)	2.0mg
L	0603	1608-10	1.60 <sup>+0.20</sup> <sub>-0.00</sub> <sup>+0.008</sup> <sub>-0.000</sub> (0.063 -0.000)	0.85 <sup>+0.15</sup> <sub>-0.00</sub> <sup>+0.006</sup> <sub>-0.000</sub> (0.033 -0.000)	0.85 <sup>+0.15</sup> <sub>-0.00</sub> <sup>+0.006</sup> <sub>-0.000</sub> (0.033 -0.000)	0.65 min.	0.15 (0.006)	8.6mg
R	0805	2012-15	2.00 <sup>+0.20</sup> <sub>-0.00</sub> <sup>+0.008</sup> <sub>-0.000</sub> (0.079 -0.000)	1.35 <sup>+0.15</sup> <sub>-0.00</sub> <sup>+0.006</sup> <sub>-0.000</sub> (0.053 -0.000)	1.35 <sup>+0.15</sup> <sub>-0.00</sub> <sup>+0.006</sup> <sub>-0.000</sub> (0.053 -0.000)	0.85 min.	0.15 (0.006)	29.9mg
A	1206	3216-18	3.20±0.20 (0.126±0.008)	1.60±0.20 (0.063±0.008)	1.60±0.20 (0.063±0.008)	2.00 min.	0.15 (0.006)	44.6mg

### HOW TO ORDER

<b>TAC</b>	<b>L</b>	<b>226</b>	<b>M</b>	<b>004</b>	<b>R</b>	<b>TA</b>
Type TACmicrochip™	Case Size 0402=K 0603=L 0805=R 1206=A	Capacitance Code pF code: 1st two digits represent significant figures, 3rd digit represents multiplier (number of zeros to follow)	Tolerance K=±10% M=±20%	Rated DC Voltage 002=2Vdc 003=3Vdc 004=4Vdc 006=6.3Vdc 010=10Vdc 016=16Vdc 020=20Vdc 025=25Vdc 035=35Vdc	Packaging (see table below)	Alternative characters may be used for special requirements

### Packaging Suffix

Reel Size	Standard Tin Termination Plastic Tape	Standard Tin Termination Paper Tape	Gold Termination Plastic Tape
Case	A/R/L	K	A/R/L
7"	RTA	PTA	ATA
4 1/4"	XTA	QTA	FTA

### TECHNICAL SPECIFICATIONS

Technical Data:	All technical data relate to an ambient temperature of +25°C									
Capacitance Range:	0.47µF to 150µF									
Capacitance Tolerance:	±10%; ±20%									
Leakage Current DCL:	0.01CV or 0.5µA whichever is the greater									
Rated Voltage (V <sub>R</sub> )	≧ +85°C:	2	3	4	6.3	10	16	20	25	35
Category Voltage (V <sub>C</sub> )	≧ +125°C:	1.3	2	2.7	4	7	10	13	17	23
Surge Voltage (V <sub>S</sub> )	≧ +85°C:	2.7	3.9	5.2	8	13	20	26	32	46
Surge Voltage (V <sub>S</sub> )	≧ +125°C:	1.7	2.6	3.2	5	8	12	16	20	28
Temperature Range:	-55°C to +125°C									
Reliability:	1% per 1000 hours at 85°C, V <sub>R</sub> with 0.1Ω/V series impedance, 60% confidence level									
Termination Finish:	Nickel and Tin Plating (standard), Nickel and Gold Plating option available upon request									

### STANDARD COMMERCIAL RANGE (EIA Sizes) (LETTER DENOTES CASE SIZE)

Capacitance		Voltage Rating DC (V <sub>R</sub> ) at 85°C								
Cap. (µF)	Code	2.0V	3.0V	4.0V	6.3V	10V	16V	20V	25V	35V
0.33	334									
0.47	474					K/L	L			
0.68	684					K/L	L			
1.0	105				K/L	K/L	L		R	R
1.5	155			L	L	L				
2.2	225		K/L	L	K/L	L	L			
3.3	335	K/L	K/L	L	L	L/R				
4.7	475	K/L	K/L	K/L	L	L/R		R		
6.8	685	L	L	L	L/R	R				
10	106	K/L	K/L	L/R	L/R	L/R	R			
15	156		R	L/R	L/R	R				
22	226	R	L/R	L/R	R	R				
33	336	R	R	R	R	A				
47	476	R	L/R	R	R/A					
68	686	R	R	A						
100	107		R/A	A	A					
150	157									
220	227	A								

Developmental Ratings - subject to change

Standard Height Profile: K, L, R, A Case

Low Profile: N, U, H, T Case

Custom Low Profile: X Case

### RATINGS & PART NUMBER REFERENCE

AVX Part No.	EIA	Case Size	Capacitance (µF)	Rated Voltage (V)	DCL (µA) Max.	DF % Max.	ESR Max. (Ω) @100kHz
TACK335M002#	0402	K	3.3	2.0	0.5	8	15
TACL335*002#	0603	L	3.3	2.0	0.5	6	7.5
TACK475M002#	0402	K	4.7	2.0	0.5	12	15
TACL475*002#	0603	L	4.7	2.0	0.5	6	7.5
TACL685*002#	0603	L	6.8	2.0	0.5	6	7.5
TACK106M002#	0402	K	10	2.0	0.5	15	15
TACL106*002#	0603	L	10	2.0	0.5	10	7.5
TACR226*002#	0805	R	22	2.0	0.7	8	5
TACR336*002#	0805	R	33	2.0	1.0	10	5
TACR476*002#	0805	R	47	2.0	1.5	10	5
TACR686M002#	0805	R	68	2.0	1.4	14	5
TACA157M002#	1206	A	150	2.0	3.0	20	1
TACK225M003#	0402	K	2.2	3.0	0.5	6	15
TACL225*003#	0603	L	2.2	3.0	0.5	6	7.5
TACK335M003#	0402	K	3.3	2.0	0.5	8	15
TACL335*003#	0603	L	3.3	3.0	0.5	6	7.5
TACK475M003#	0402	K	4.7	3.0	0.5	12	15
TACL475*003#	0603	L	4.7	3.0	0.5	6	7.5
TACL685*003#	0603	L	6.8	3.0	0.5	6	7.5
TACK106M003#	0402	K	10	3.0	0.5	15	15
TACL106*003#	0603	L	10	3.0	0.5	10	7.5
TACR156*003#	0805	R	15	3.0	0.5	8	5
TACL226M003#	0603	L	22	3.0	0.7	20	7.5
TACR226*003#	0805	R	22	3.0	0.7	8	5
TACR336*003#	0805	R	33	3.0	1.0	10	5
TACR476*003#	0805	R	47	3.0	1.5	10	5
TACR686M003#	0805	R	68	3.0	2.0	14	5
TACA107M003#	1206	A	100	3.0	3.0	15	1
TACL155*004#	0603	L	1.5	4.0	0.5	6	7.5
TACL225*004#	0603	L	2.2	4.0	0.5	6	7.5
TACL335*004#	0603	L	3.3	4.0	0.5	6	7.5
TACK475M004#	0402	K	4.7	4.0	0.5	15	15
TACL475*004#	0603	L	4.7	4.0	0.5	6	7.5
TACL685*004#	0603	L	6.8	4.0	0.5	8	7.5
TACL106M004#	0603	L	10	4.0	0.5	10	7.5
TACR106*004#	0805	R	10	4.0	0.5	8	5
TACL156M004#	0603	L	15	4.0	0.6	20	7.5
TACR156*004#	0805	R	15	4.0	0.6	8	5
TACL226M004#	0603	L	22	4.0	0.9	20	7.5
TACR226*004#	0805	R	22	4.0	0.9	8	5
TACR336*004#	0805	R	33	4.0	1.3	10	5
TACR476M004#	0805	R	47	4.0	1.9	14	5
TACA686M004#	1206	A	68	4.0	2.7	15	1
TACA107M004#	1206	A	100	4.0	4.0	20	1

AVX Part No.	EIA	Case Size	Capacitance (µF)	Rated Voltage (V)	DCL (µA) Max.	DF % Max.	ESR Max. (Ω) @100kHz
TACK105M006#	0402	K	1.0	6.3	0.5	6	15
TACL105*006#	0603	L	1.0	6.3	0.5	6	7.5
TACL155*006#	0603	L	1.5	6.3	0.5	6	7.5
TACK225M006#	0402	K	2.2	6.3	0.5	8	15
TACL225*006#	0603	L	2.2	6.3	0.5	6	7.5
TACL335*006#	0603	L	3.3	6.3	0.5	6	7.5
TACL475*006#	0603	L	4.7	6.3	0.5	8	7.5
TACL685*006#	0603	L	6.8	6.3	0.5	10	7.5
TACR685*006#	0805	R	6.8	6.3	0.5	8	5
TACL106M006#	0603	L	10	6.3	0.6	10	6
TACR106*006#	0805	R	10	6.3	0.6	8	5
TACL156M006#	0603	L	15	6.0	0.9	20	7.5
TACR156*006#	0805	R	15	6.3	0.9	8	5
TACR226*006#	0805	R	22	6.3	1.4	10	5
TACR336*006#	0805	R	33	6.3	2.1	12	5
TACA476M006#	1206	A	47	6.3	3.0	15	1
TACA107M006#	1206	A	100	6.3	6.3	20	1
TACK474M010#	0402	K	0.47	10.0	0.5	6	15
TACL474*010#	0603	L	0.47	10.0	0.5	6	7.5
TACK684M010#	0402	K	0.68	10.0	0.5	8	15
TACL684*010#	0603	L	0.68	10.0	0.5	6	7.5
TACK105M010#	0402	K	1.0	10.0	0.5	6	15
TACL105*010#	0603	L	1.0	10.0	0.5	6	7.5
TACL155*010#	0603	L	1.5	10.0	0.5	6	7.5
TACL225*010#	0603	L	2.2	10.0	0.5	6	7.5
TACL335*010#	0603	L	3.3	10.0	0.5	8	7.5
TACR335*010#	0805	R	3.3	10.0	0.5	8	5
TACL475M010#	0603	L	4.7	10.0	0.5	10	6
TACR475*010#	0805	R	4.7	10.0	0.5	8	6
TACR685*010#	0805	R	6.8	10.0	0.7	8	5
TACL106M010#	0603	L	10	10.0	1.0	20	7.5
TACR106*010#	0805	R	10	10.0	1.0	8	5
TACR156*010#	0805	R	15	10.0	1.5	10	5
TACR226M010#	0805	R	22	10.0	2.2	14	5
TACA226M010#	1206	A	22	10.0	2.2	10	1
TACA336M010#	1206	A	33	10.0	3.3	12	1
TACL474*016#	0603	L	0.47	16.0	0.5	6	7.5
TACL684*016#	0603	L	0.68	16.0	0.5	6	7.5
TACL105*016#	0603	L	1.0	16.0	0.5	6	7.5
TACL225M016#	0603	L	2.2	16.0	0.5	10	7.5
TACR106*016#	0805	R	10	16.0	1.6	10	5
TACR475M020#	0805	R	4.7	20.0	0.9	8	5
TACR105*025#	0805	R	1.0	25.0	0.5	8	5

All technical data relates to an ambient temperature of +25°C. Capacitance and DF are measured at 120Hz, 0.5V RMS with a maximum DC bias of 2.2 volts. DCL is measured at rated voltage after 5 minutes.

\* Insert K for ±10% and M for ±20% Capacitance Tolerance

# Refer to packaging suffix for options

**NOTE: AVX reserves the right to supply a higher voltage rating or tighter tolerance part in the same case size, to the same reliability standards.**

# TLC Series



## Tantalum Solid Electrolytic Chip Capacitors Consumer Series

- Super High Volumetric Efficiency
- Environmentally Friendly Component
- Small & Low Profile Case Sizes
- Leadfree Assembly Systems
- Consumer Applications

The consumer TLC series of tantalum capacitors offers high capacitance vs. voltage ratio based on stable MnO<sub>2</sub> electrode capacitors. The TLC series complies with RoHS requirements and it is an environmentally friendly component ready for lead-free assembly systems. The TLC series is suitable for wide range of consumer electronic applications such as the latest portable handheld electronics, cellular phones, PDAs or other digital equipment and cameras.



LEAD-FREE

LEAD-FREE COMPATIBLE COMPONENT



HALOGEN-FREE COMPOUNDS

ENVIRONMENTAL FRIENDLY COMPONENT

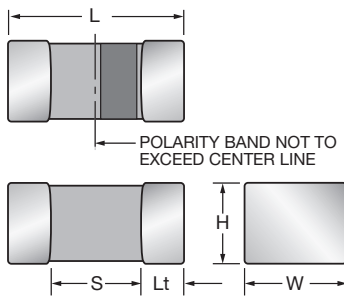

### CASE DIMENSIONS: millimeters (inches)

Code	EIA Code	EIA Metric	Length (L)	Width (W)	Height (H)	Termination Spacing(S)	Minimum Termination Length (Lt)	Average Mass
K	0402	1005-07	1.00 <sup>+0.20</sup> <sub>-0.00</sub> (0.039 <sup>+0.008</sup> <sub>-0.000</sub> )	0.50 <sup>+0.20</sup> <sub>-0.00</sub> (0.020 <sup>+0.008</sup> <sub>-0.000</sub> )	0.50 <sup>+0.20</sup> <sub>-0.00</sub> (0.020 <sup>+0.008</sup> <sub>-0.000</sub> )	0.40 min. (0.016 min)	0.10 (0.004)	2.0mg
L	0603	1608-10	1.60 <sup>+0.20</sup> <sub>-0.00</sub> (0.063 <sup>+0.008</sup> <sub>-0.000</sub> )	0.85 <sup>+0.15</sup> <sub>-0.00</sub> (0.033 <sup>+0.006</sup> <sub>-0.000</sub> )	0.85 <sup>+0.15</sup> <sub>-0.00</sub> (0.033 <sup>+0.006</sup> <sub>-0.000</sub> )	0.65 min. (0.025 min)	0.15 (0.006)	8.6mg
R	0805	2012-15	2.50 <sup>+0.20</sup> <sub>-0.00</sub> (0.098 <sup>+0.008</sup> <sub>-0.000</sub> )	1.35 <sup>+0.15</sup> <sub>-0.00</sub> (0.053 <sup>+0.006</sup> <sub>-0.000</sub> )	1.35 <sup>+0.15</sup> <sub>-0.00</sub> (0.053 <sup>+0.006</sup> <sub>-0.000</sub> )	0.85 min. (0.033 min)	0.15 (0.006)	29.9mg
T	3528	3528-12	3.50 <sup>+0.20</sup> <sub>-0.00</sub> (0.138 <sup>+0.008</sup> <sub>-0.000</sub> )	2.80 <sup>+0.15</sup> <sub>-0.00</sub> (0.117 <sup>+0.006</sup> <sub>-0.000</sub> )	1.20 max (0.047 max)	2.30 min. (0.091 min)	0.15 (0.006)	65mg

### Packaging Suffix/Quantity

Case Size	Standard Tin Termination		Gold Termination		Tape Type/Width
	4¼ inch Reel	7 inch Reel	4¼ inch Reel	7 inch Reel	
K	QTA / 1,000	PTA / 10,000	—	—	Paper / 8mm
L	XTA / 500	RTA / 3,500	FTA / 500	ATA / 3,500	Plastic / 8mm
R	XTA / 500	RTA / 2,500	FTA / 500	ATA / 2,500	Plastic / 8mm
T	XTA / 500	RTA / 2,500	—	—	Plastic / 8mm

## HOW TO ORDER

**TLC**

Type

**L**

Case Size  
See table above

**226**

Capacitance Code  
pF code: 1st two digits represent significant figures, 3rd digit represents multiplier (number of zeros to follow)

**M**

Tolerance  
M=±20%

**006**

Rated DC Voltage  
003=3Vdc  
004=4Vdc  
006=6.3Vdc  
010=10Vdc

**R**

Packaging  
See table above

## TECHNICAL SPECIFICATIONS

Technical Data:	All technical data relate to an ambient temperature of +25°C				
Capacitance Range:	4.7µF to 68µF				
Capacitance Tolerance:	±20%				
Rated Voltage (V <sub>R</sub> )	-55°C ≤ +40°C:	3	4	6.3	10
Category Voltage (V <sub>C</sub> )	at 85°C:	1.5	2	3.2	5
Category Voltage (V <sub>C</sub> )	at 125°C:	0.6	0.8	1.3	2
Temperature Range:	-55°C to +125°C with category voltage				
Reliability:	0.2% per 1000 hours at 85°C, 0.5xV <sub>R</sub> , with 0.1Ω/V series impedance with 60% confidence level				



# TLC Series



## Tantalum Solid Electrolytic Chip Capacitors Consumer Series

### COMMERCIAL RANGE (LETTER DENOTES CASE SIZE)

Capacitance		Voltage Rating DC ( $V_R$ ) at 85°C			
Cap. ( $\mu\text{F}$ )	Code	3.0V	4.0V	6.3V	10V
4.7	475		K	K	
6.8	685				
10	106	K	K		
15	156				
22	226			L	
33	336		L		
47	476	L		R	
68	686		R		
100	107	R			T

Developmental Ratings - subject to change

### RATINGS & PART NUMBER REFERENCE

AVX Part No.	EIA	Case Size	Capacitance ( $\mu\text{F}$ )	Rated Voltage (V)	DCL ( $\mu\text{A}$ ) Max.	ESR max @100kHz ( $\Omega$ )
TLCK106M003#	0402	K	10	3.0	0.5	15
TLCK475M004#	0402	K	4.7	4.0	0.5	15
TLCR686M004#	0805	R	68	4.0	2.7	5
TLCL226M006#	0603	L	22	6.3	1.4	7.5
TLCR476M006#	0805	R	47	6.3	3.0	5

# Refer to packaging suffix table for options.

All technical data relates to an ambient temperature of +25°C. Capacitance and DF are measured at 120Hz, 0.5 RMS with DC bias of 1.5V. DCL is measured at rated voltage after 5 minutes.

ESR allowed to move up to 1.25 times catalog limit post mounting.

DCL allowed to move up to 2.00 times catalog limit post mounting.

**NOTE: AVX reserves the right to supply a higher voltage rating in the same case size, to the same reliability standards.**

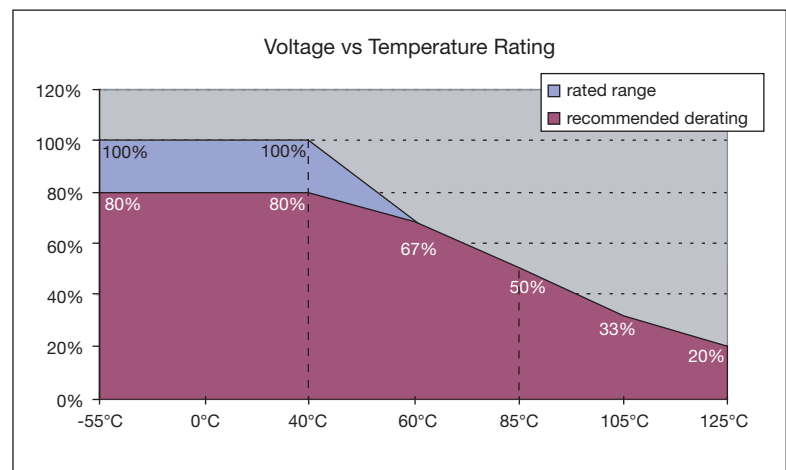

## Low Profile



Five additional case sizes are available in the TAJ range offering low profile solid tantalum chip capacitors. Designed for applications where maximum height of components above or below board are of prime consideration, this height of 1.2,

1.5 and 2.0mm equates to that of a standard integrated circuit package after mounting. The S&T footprints are identical to the A&B case size parts and the W&Y footprints to C&D case size parts.

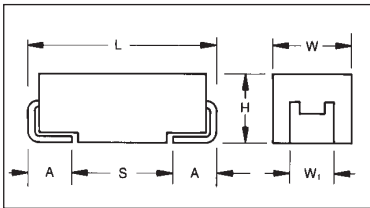

For part marking see page 121

### CASE DIMENSIONS: millimeters (inches)

Code	EIA Code	L±0.20 (0.008)	W+0.20 (0.008) -0.10 (0.004)	H Max.	W <sub>1</sub> ±0.20 (0.008)	A+0.30 (0.012) -0.20 (0.008)	S Min.
R*	2012-12	2.05 (0.081)	1.30 (0.051)	1.20 (0.047)	1.0±0.1 (0.039±0.004)	0.50 (0.020)	0.85 (0.033)
P	2012-15	2.05 (0.081)	1.35 (0.053)	1.50 (0.059)	1.0±0.1 (0.039±0.004)	0.50 (0.020)	0.85 (0.033)
S**	3216-12	3.20 (0.126)	1.60 (0.063)	1.20 (0.047)	1.20 (0.047)	0.80 (0.031)	1.10 (0.043)
T**	3528-12	3.50 (0.138)	2.80 (0.110)	1.20 (0.047)	2.20 (0.087)	0.80 (0.031)	1.40 (0.055)
W**	6032-15	6.00 (0.236)	3.20 (0.126)	1.50 (0.059)	2.20 (0.087)	1.30 (0.051)	2.90 (0.114)
Y**	7343-20	7.30 (0.287)	4.30 (0.169)	2.00 (0.079)	2.40 (0.094)	1.30 (0.051)	4.40 (0.173)
X**	7343-15	7.30 (0.287)	4.30 (0.169)	1.50 (0.059)	2.40 (0.094)	1.30 (0.051)	4.40 (0.173)

\* 0805 Footprint Compatible  
 \*\* Low Profile Versions of A & B & C & D Case, respectively  
 W<sub>1</sub> dimension applies to the termination width for A dimensional area only.

### HOW TO ORDER

**TAJ**

Type

**Y**

Case Size  
See table above

**107**

Capacitance Code  
pF code: 1st two digits represent significant figures  
3rd digit represents multiplier (number of zeros to follow)

**M**

Tolerance  
K=±10%  
M=±20%

**010**

Rated DC Voltage  
002=2.5Vdc  
004=4Vdc  
006=6.3Vdc  
010=10Vdc  
016=16Vdc  
020=20Vdc  
025=25Vdc  
035=35Vdc  
050=50Vdc

**R**

Packaging  
R = 7" T/R  
(Lead Free since production date 1/1/04)  
S = 13" T/R  
(Lead Free since production date 1/1/04)  
A = Gold Plating  
7" Reel  
B = Gold Plating  
13" Reel

**\*\***

Additional characters may be added for special requirements

### TECHNICAL SPECIFICATIONS

Technical Data:	All technical data relate to an ambient temperature of +25°C									
Capacitance Range:	0.1µF to 680µF									
Capacitance Tolerance:	±10%; ±20%									
Rated Voltage (V <sub>R</sub> )	≧ +85°C:	2.5	4	6.3	10	16	20	25	35	50
Category Voltage (V <sub>C</sub> )	≧ +125°C:	1.7	2.7	4	7	10	13	17	23	33
Surge Voltage (V <sub>S</sub> )	≧ +85°C:	3.3	5.2	8	13	20	26	32	46	65
Surge Voltage (V <sub>S</sub> )	≧ +125°C:	2.2	3.4	5	8	13	16	20	28	40
Temperature Range:	-55°C to +125°C									
Reliability:	1% per 1000 hours at 85°C, V <sub>R</sub> with 0.1Ω/V series impedance, 60% confidence level									
	Meets requirements of AEC-Q200									

### CAPACITANCE AND VOLTAGE RANGE, $V_R$ (VOLTAGE CODE) RANGE (LETTER DENOTES CASE SIZE)

Capacitance		Rated voltage DC ( $V_R$ ) to 85°C								
$\mu\text{F}$	Code	2.5V (e)	4V (G)	6.3V (J)	10V (A)	16V (C)	20V (D)	25V (E)	35V (V)	50V (T)
0.10	104						R/S		R/S	S
0.15	154						R/S	R	R/S	S
0.22	224						R/S	R	R/S	S
0.33	334						R/S	R	R/S	T
0.47	474						R/S	R/S	R/S/T	T
0.68	684					R/S	R/S/T	R/S	S/T	
1.0	105				R/S	R/S/T	R/S/T	S	S/T	W
1.5	155			R/S	R/S	R/S	R/S/T	S/T	T	W
2.2	225		R/S	R/S	R/S	R/S/T	S/T	T	T	
3.3	335		R/S	R/S	R/S/T	R/S/T	T	T/W	W	Y
4.7	475	R	R/S	R/S/T	R/S/T	P/S/T	T	W	W	
6.8	685	R	R/S/T	R/S/T	P/R/S/T	S/T	T	W	Y	
10	106	R/S	R/S/T	R/S/T	P <sup>(M)</sup> /S/T	T/W	W	W	X/Y	
15	156	R	R/S/T	P/R/S/T	S/T/W	T <sup>(M)</sup> /W	W	Y	Y	
22	226	P/R	P/R/S/T	P <sup>(M)</sup> /S/T/W	T/W	W	W/Y	Y		
33	336	P/S	P <sup>(M)</sup> /S/T/W	T/W	W	W/Y	X/Y			
47	476	P <sup>(M)</sup> /S	T/W	T/W	W/Y	W/X/Y	Y			
68	686	T	T/W	W	W/Y	X/Y	Y			
100	107	T/W	T <sup>(M)</sup> /W	W/Y	W/X/Y	Y				
150	157	T <sup>(M)</sup> /W	W/Y	W/X/Y	X <sup>(M)</sup> /Y					
220	227	Y	W/X/Y	X/Y	Y					
330	337	Y	X	Y						
470	477	Y	Y							
680	687	Y								
1000	108	Y <sup>(M)</sup>								

Released codes <sup>(M tolerance only)</sup>

Developmental Ratings - subject to change.

Note: Voltage ratings are minimum values. AVX reserves the right to supply higher ratings in the same case size, to the same reliability standards.



### RATINGS & PART NUMBER REFERENCE

AVX Part No.	Case Size	Capacitance (μF)	Rated Voltage (V)	DCL (μA) Max.	DF % Max.	ESR Max. (Ω) @100kHz
TAJR475*002#	R	4.7	2.5	0.5	6	20
TAJR685*002#	R	6.8	2.5	0.5	6	20
TAJR106*002#	R	10	2.5	0.5	8	4.5
TAJS106*002#	S	10	2.5	0.5	6	8
TAJR156*002#	R	15	2.5	0.5	8	4.1
TAJP226*002#	P	22	2.5	0.5	8	3.5
TAJR226*002#	R	22	2.5	0.5	8	3.8
TAJP336*002#	P	33	2.5	0.7	8	3.5
TAJS336*002#	S	33	2.5	0.7	8	1.5
TAJP476M002#	P	47	2.5	1.2	12	3.2
TAJS476*002#	S	47	2.5	1.2	8	1.6
TAJT686*002#	T	68	2.5	1.4	8	1.5
TAJT107*002#	T	100	2.5	2.5	15	1.3
TAJW107*002#	W	100	2.5	2.5	8	0.4
TAJT157M002#	T	150	2.5	3.8	18	1.2
TAJW157*002#	W	150	2.5	3.8	8	0.3
TAJY227*002#	Y	220	2.5	5.5	8	0.3
TAJY337*002#	Y	330	2.5	8.2	8	0.3
TAJY477*002#	Y	470	2.5	11	12	0.2
TAJY687*002#	Y	680	2.5	17	12	0.2
TAJY108M002#	Y	108	2.5	25	30	0.2
TAJR225*004#	R	2.2	4	0.5	6	25
TAJS225*004#	S	2.2	4	0.5	6	25
TAJR335*004#	R	3.3	4	0.5	6	20
TAJS335*004#	S	3.3	4	0.5	6	18
TAJR475*004#	R	4.7	4	0.5	6	12
TAJS475*004#	S	4.7	4	0.5	6	10
TAJR685*004#	R	6.8	4	0.5	6	5.2
TAJS685*004#	S	6.8	4	0.5	6	8
TAJT685*004#	T	6.8	4	0.5	6	6
TAJR106*004#	R	10	4	0.5	6	7
TAJS106*004#	S	10	4	0.5	6	6
TAJT106*004#	T	10	4	0.6	6	5
TAJR156*004#	R	15	4	0.6	8	4
TAJS156*004#	S	15	4	0.6	8	4
TAJT156*004#	T	15	4	0.6	6	2
TAJP226*004#	P	22	4	0.9	8	5
TAJR226*004#	R	22	4	0.9	8	3.8
TAJS226*004#	S	22	4	0.9	8	3.5
TAJT226*004#	T	22	4	0.9	6	1.9
TAJP336M004#	P	33	4	1.3	8	3.4
TAJS336*004#	S	33	4	1.3	8	1.7
TAJT336*004#	T	33	4	1.3	6	1.7
TAJW336*004#	W	33	4	1.3	6	0.6
TAJT476*004#	T	47	4	1.9	10	2
TAJW476*004#	W	47	4	1.9	6	0.5
TAJT686*004#	T	68	4	2.7	15	1.5
TAJW686*004#	W	68	4	2.7	6	0.4
TAJT107M004#	T	100	4	4	14	1.4
TAJW107*004#	W	100	4	4	6	1.3
TAJW157*004#	W	150	4	6	6	1.3
TAJY157*004#	Y	150	4	6	6	0.4
TAJW227*004#	W	220	4	8.8	8	1.2
TAJX227*004#	X	220	4	8.8	8	0.9
TAJY227*004#	Y	220	4	8.8	8	0.3
TAJX337*004#	X	330	4	13.2	8	0.1
TAJY477*004#	Y	470	4	18.8	14	0.9
TAJR155*006#	R	1.5	6.3	0.5	6	25
TAJS155*006#	S	1.5	6.3	0.5	6	25
TAJR225*006#	R	2.2	6.3	0.5	6	20
TAJS225*006#	S	2.2	6.3	0.5	6	18

AVX Part No.	Case Size	Capacitance (μF)	Rated Voltage (V)	DCL (μA) Max.	DF % Max.	ESR Max. (Ω) @100kHz
TAJR335*006#	R	3.3	6.3	0.5	6	12
TAJS335*006#	S	3.3	6.3	0.5	6	9
TAJR475*006#	R	4.7	6.3	0.5	6	7
TAJS475*006#	S	4.7	6.3	0.5	6	7.5
TAJT475*006#	T	4.7	6.3	0.5	6	6
TAJR685*006#	R	6.8	6.3	0.5	8	7
TAJS685*006#	S	6.8	6.3	0.5	6	2.6
TAJT685*006#	T	6.8	6.3	0.5	6	5
TAJR106*006#	R	10	6.3	0.6	8	6
TAJS106*006#	S	10	6.3	0.6	6	6
TAJT106*006#	T	10	6.3	0.6	6	4
TAJP156*006#	P	15	6.3	0.9	8	3.5
TAJR156*006#	R	15	6.3	0.9	8	4.1
TAJS156*006#	S	15	6.3	0.9	8	4
TAJT156*006#	T	15	6.3	0.9	6	3.5
TAJP226M006#	P	22	6.3	1.3	8	3.8
TAJR226*006#	R	22	6.3	1.3	10	1.8
TAJT226*006#	T	22	6.3	1.4	8	2.5
TAJW226*006#	W	22	6.3	1.3	6	0.6
TAJT336*006#	T	33	6.3	2.1	10	2.5
TAJW336*006#	W	33	6.3	2.1	6	1.8
TAJT476*006#	T	47	6.3	2.8	10	1.6
TAJW476*006#	W	47	6.3	3	6	1.5
TAJW686*006#	W	68	6.3	4.3	6	1.5
TAJY107*006#	Y	100	6.3	6.3	6	0.9
TAJW107*006#	W	100	6.3	6.3	6	0.9
TAJW157*006#	W	157	6.3	9	8	0.3
TAJX157*006#	X	150	6.3	9.5	6	0.9
TAJY157*006#	Y	150	6.3	9	6	0.4
TAJX227*006#	X	220	6.3	13.2	8	0.3
TAJY227*006#	Y	220	6.3	13.9	10	0.9
TAJY337*006#	Y	330	6.3	20.8	8	0.9
TAJR105*010#	R	1	10	0.5	4	25
TAJS105*010#	S	1	10	0.5	4	25
TAJR155*010#	R	1.5	10	0.5	6	20
TAJS155*010#	S	1.5	10	0.5	6	20
TAJR225*010#	R	2.2	10	0.5	6	15
TAJS225*010#	S	2.2	10	0.5	6	12
TAJR335*010#	R	3.3	10	0.5	6	8
TAJS335*010#	S	3.3	10	0.5	6	8
TAJT335*010#	T	3.3	10	0.5	6	6
TAJR475*010#	R	4.7	10	0.5	6	9
TAJS475*010#	S	4.7	10	0.5	6	5
TAJT475*010#	T	4.7	10	0.5	6	5
TAJP685*010#	P	6.8	10	0.7	6	4
TAJR685*010#	R	6.8	10	0.7	6	5.2
TAJS685*010#	S	6.8	10	0.7	6	4
TAJT685*010#	T	6.8	10	0.7	6	4
TAJP106M010#	P	10	10	1	8	6
TAJS106*010#	S	10	10	1	8	4
TAJT106*010#	T	10	10	1	6	3
TAJS156*010#	S	15	10	1.5	6	2
TAJT156*010#	T	15	10	1.5	8	2.8
TAJW156*010#	W	15	10	1.5	6	0.7
TAJT226*010#	T	22	10	2.2	8	2.2
TAJW226*010#	W	22	10	2.2	6	0.6
TAJW336*010#	W	33	10	3.3	6	1.6
TAJW476*010#	W	47	10	4.7	6	1.4
TAJY476*010#	Y	47	10	4.7	6	0.5
TAJY686*010#	Y	68	10	6.8	6	0.9

All technical data relates to an ambient temperature of +25°C. Capacitance and DF are measured at 120Hz, 0.5V RMS with a maximum DC bias of 2.2 volts. DCL is measured at rated voltage after 5 minutes.

\* Insert K for ±10% and M for ±20%  
Capacitance Tolerance

# Standard Plating – Insert R for 7" reel and S for 13" reel  
# Gold Plating – Insert A for 7" reel and B for 13" reel

NOTE: AVX reserves the right to supply a higher voltage rating or tighter tolerance part in the same case size, to the same reliability standards.



## Low Profile

### RATINGS & PART NUMBER REFERENCE

AVX Part No.	Case Size	Capacitance (μF)	Rated Voltage (V)	DCL (μA) Max.	DF % Max.	ESR Max. (Ω) @100kHz
TAJW686*010#	W	68	10	6.8	6	1.3
TAJW107*010#	W	100	10	10	6	0.4
TAJX107*010#	X	100	10	10	8	0.9
TAJY107*010#	Y	100	10	10	6	0.9
TAJX157M010#	X	150	10	15	6	0.3
TAJY157*010#	Y	150	10	15	6	1.2
TAJY227*010#	Y	220	10	22	10	0.5
TAJR684*016#	R	0.68	16	0.5	4	25
TAJS684*016#	S	0.68	16	0.5	4	25
TAJR105*016#	R	1	16	0.5	4	20
TAJS105*016#	S	1	16	0.5	4	15
TAJT105*016#	T	1	16	0.5	4	5
TAJR155*016#	R	1.5	16	0.5	6	10
TAJS155*016#	S	1.5	16	0.5	6	12
TAJR225*016#	R	2.2	16	0.5	6	6.5
TAJS225*016#	S	2.2	16	0.5	6	6
TAJT225*016#	T	2.2	16	0.5	6	6.5
TAJR335*016#	R	3.3	16	0.5	8	5
TAJS335*016#	S	3.3	16	0.5	6	5
TAJT335*016#	T	3.3	16	0.5	6	5
TAJP475*016#	P	4.7	16	0.8	8	5
TAJS475*016#	S	4.7	16	0.8	8	4.5
TAJT475*016#	T	4.7	16	0.8	6	3.1
TAJS685*016#	S	6.8	16	1.1	8	2.4
TAJT685*016#	T	6.8	16	1.1	6	3.5
TAJT106*016#	T	10	16	1.6	8	2.2
TAJW106*016#	W	10	16	1.6	6	2
TAJT156M016#	T	15	16	2.4	6	2
TAJW156*016#	W	15	16	2.4	6	0.7
TAJW226*016#	W	22	16	3.5	6	1.6
TAJW336*016#	W	33	16	5.3	6	1.5
TAJY336*016#	Y	33	16	5.3	6	0.9
TAJW476*016#	W	47	16	7.5	6	0.4
TAJX476*016#	X	47	16	7.5	6	0.9
TAJY476*016#	Y	47	16	7.5	6	0.7
TAJX686*016#	X	68	16	10.9	8	0.6
TAJY686*016#	Y	68	16	10.9	6	0.9
TAJY107*016#	Y	100	16	16	8	0.9
TAJR104*020#	R	0.1	20	0.5	4	25
TAJS104*020#	S	0.1	20	0.5	4	25
TAJR154*020#	R	0.15	20	0.5	4	25
TAJS154*020#	S	0.15	20	0.5	4	25
TAJR224*020#	R	0.22	20	0.5	4	25
TAJS224*020#	S	0.22	20	0.5	4	25
TAJR334*020#	R	0.33	20	0.5	4	25
TAJS334*020#	S	0.33	20	0.5	4	25
TAJR474*020#	R	0.47	20	0.5	4	25
TAJS474*020#	S	0.47	20	0.5	4	25
TAJR684*020#	R	0.68	20	0.5	4	20
TAJS684*020#	S	0.68	20	0.5	4	25
TAJT684*020#	T	0.68	20	0.5	4	15
TAJR105*020#	R	1	20	0.5	4	20
TAJS105*020#	S	1	20	0.5	4	12
TAJT105*020#	T	1	20	0.5	4	9
TAJR155*020#	R	1.5	20	0.5	6	9.6
TAJS155*020#	S	1.5	20	0.5	6	5
TAJT155*020#	T	1.5	20	0.5	6	6.5
TAJS225*020#	S	2.2	20	0.5	6	3
TAJT225*020#	T	2.2	20	0.5	6	6
TAJT335*020#	T	3.3	20	0.7	6	3

AVX Part No.	Case Size	Capacitance (μF)	Rated Voltage (V)	DCL (μA) Max.	DF % Max.	ESR Max. (Ω) @100kHz
TAJT475*020#	T	4.7	20	0.9	6	3
TAJT685*020#	T	6.8	20	1.4	6	2.6
TAJW106*020#	W	10	20	2	6	1.9
TAJW156*020#	W	15	20	3	6	1.7
TAJY226*020#	Y	22	20	4.4	6	0.9
TAJW226*020#	W	22	20	4.4	6	1.6
TAJX336*020#	X	33	20	6.6	6	0.5
TAJY336*020#	Y	33	20	6.6	6	0.5
TAJY476*020#	Y	47	20	9.4	6	0.4
TAJY686*020#	Y	68	20	13.6	6	0.4
TAJR154*025#	R	0.15	25	0.5	4	24
TAJR224*025#	R	0.22	25	0.5	4	21
TAJR334*025#	R	0.33	25	0.5	4	17
TAJR474*025#	R	0.47	25	0.5	4	15
TAJS474*025#	S	0.47	25	0.5	4	14
TAJR684*025#	R	0.68	25	0.5	4	13
TAJS684*025#	S	0.68	25	0.5	4	10
TAJS105*025#	S	1	25	0.5	4	8
TAJS155*025#	S	1.5	25	0.5	6	5.4
TAJT155*025#	T	1.5	25	0.5	6	5
TAJT225*025#	T	2.2	25	0.6	6	4.5
TAJT335*025#	T	3.3	25	0.8	6	3.5
TAJW335*025#	W	3.3	25	0.8	6	1.6
TAJW475*025#	W	4.7	25	1.2	6	1.2
TAJW685*025#	W	6.8	25	1.7	6	2
TAJW106*025#	W	10	25	2.5	6	1.8
TAJY156*025#	Y	15	25	3.8	6	1
TAJY226*025#	Y	22	25	5.5	6	0.9
TAJR104*035#	R	0.1	35	0.5	4	29
TAJS104*035#	S	0.1	35	0.5	4	24
TAJR154*035#	R	0.15	35	0.5	4	24
TAJS154*035#	S	0.15	35	0.5	4	21
TAJR224*035#	R	0.22	35	0.5	4	21
TAJS224*035#	S	0.22	35	0.5	4	18
TAJR334*035#	R	0.33	35	0.5	4	17
TAJS334*035#	S	0.33	35	0.5	4	15
TAJR474*035#	R	0.47	35	0.5	4	15
TAJS474*035#	S	0.47	35	0.5	4	12
TAJT474*035#	T	0.47	35	0.5	4	10
TAJS684*035#	S	0.68	35	0.5	4	8
TAJT684*035#	T	0.68	35	0.5	4	8
TAJS105*035#	S	1	35	0.5	4	7.5
TAJT105*035#	T	1	35	5	4	6.5
TAJT155*035#	T	1.5	35	0.5	6	5.2
TAJT225*035#	T	2.2	35	0.8	6	4.2
TAJW335*035#	W	3.3	35	1.2	6	1.6
TAJW475*035#	W	4.7	35	1.6	6	2.2
TAJY685*035#	Y	6.8	35	2.3	6	0.9
TAJX106*035#	X	10	35	3.5	6	0.7
TAJY106*035#	Y	10	35	3.5	6	1
TAJY156*035#	Y	15	35	5.3	6	0.6
TAJS104*050#	S	0.1	50	0.5	4	19
TAJS154*050#	S	0.15	50	0.5	4	16
TAJS224*050#	S	0.22	50	0.5	4	13
TAJT334*050#	T	0.33	50	0.5	4	11
TAJT474*050#	T	0.47	50	0.5	4	9.5
TAJW105*050#	W	1	50	0.5	6	4.4
TAJW155*050#	W	1.5	50	0.8	6	3.1
TAJY335*050#	Y	3.3	50	1.7	4	1.7

All technical data relates to an ambient temperature of +25°C. Capacitance and DF are measured at 120Hz, 0.5V RMS with a maximum DC bias of 2.2 volts. DCL is measured at rated voltage after 5 minutes.

\* Insert K for ±10% and M for ±20%      # Standard Plating      – Insert R for 7" reel and S for 13" reel  
Capacitance Tolerance                      # Gold Plating                      – Insert A for 7" reel and B for 13" reel

NOTE: AVX reserves the right to supply a higher voltage rating or tighter tolerance part in the same case size, to the same reliability standards.

## Low Profile

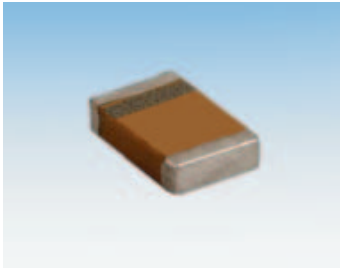

The flexibility of the TACmicrochip™ product line is once more demonstrated by our ability to produce parts with a profile as low as 0.60mm (maximum) with a maximum CV of 4.7µF at 4V in an 0805 (2012M) footprint.



LEAD-FREE



HALOGEN-FREE COMPOUNDS  
ENVIRONMENTAL FRIENDLY COMPONENT

### CASE DIMENSIONS: millimeters (inches)

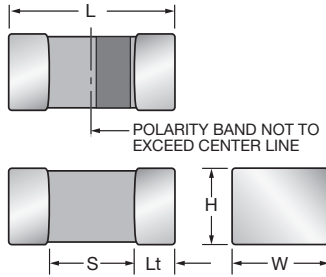

Code	EIA Code	EIA Metric	Length (L)	Width (W)	Height (H)	Termination Spacing(S)	Minimum Termination Length (Lt)	Average Mass
N	0402	1005-05	1.00 ±0.05 (0.039 ±0.002)	0.50 <sup>+0.00</sup> <sub>-0.10</sub> (0.020 <sup>+0.000</sup> <sub>-0.004</sub> )	0.50 max. (0.020 max.)	0.40 min.	0.10 (0.004)	1.5mg
U	0805	2012-06	2.00 <sup>+0.20</sup> <sub>-0.00</sub> (0.079 <sup>+0.008</sup> <sub>-0.000</sub> )	1.35 <sup>+0.15</sup> <sub>-0.00</sub> (0.053 <sup>+0.006</sup> <sub>-0.000</sub> )	0.60 max. (0.024 max.)	0.85 min.	0.15 (0.006)	8.9mg
H	0805	2012-10	2.00 <sup>+0.20</sup> <sub>-0.00</sub> (0.079 <sup>+0.008</sup> <sub>-0.000</sub> )	1.35 <sup>+0.15</sup> <sub>-0.00</sub> (0.053 <sup>+0.006</sup> <sub>-0.000</sub> )	1.00 max. (0.039 max.)	0.85 min.	0.15 (0.006)	17.1mg
T	3528	3528-12	3.50 <sup>+0.20</sup> <sub>-0.20</sub> (0.138 <sup>+0.008</sup> <sub>-0.008</sub> )	2.80 <sup>+0.20</sup> <sub>-0.10</sub> (0.110 <sup>+0.008</sup> <sub>-0.004</sub> )	1.20 max. (0.047 max.)	2.30 min.	0.15 (0.006)	65mg

### CUSTOM CASE DIMENSIONS: millimeters (inches)

Code	EIA Code	EIA Metric	Length (L)	Width (W)	Height (H)	Termination Spacing(S)	Minimum Termination Length (Lt)	Average Mass
X	1105	3015-15	3.00±0.10 (0.118±0.004)	1.45±0.10 (0.057±0.004)	1.45±0.10 (0.057±0.004)	2.00 min.	0.15 (0.006)	39.4mg

## HOW TO ORDER

<b>TAC</b>	<b>U</b>	<b>475</b>	<b>M</b>	<b>004</b>	<b>R</b>	<b>TA</b>
Type TACmicrochip™	Case Size 0402=N 0805=U 0805=H 3528=T 1105=X	Capacitance Code pF code: 1st two digits represent significant figures, 3rd digit represents multiplier (number of zeros to follow)	Tolerance K=±10% M=±20%	Rated DC Voltage 002=2Vdc 003=3Vdc 004=4Vdc 006=6.3Vdc 010=10Vdc 016=16Vdc	Packaging (see table below)	Alternative characters may be used for special requirements

### Packaging Suffix

Reel Size	Standard Tin Termination Plastic Tape	Standard Tin Termination Paper Tape	Gold Termination Plastic Tape
Case	T/H/J	N	T/H/J
7"	RTA	PTA	ATA
4½"	XTA	QTA	FTA

## TECHNICAL SPECIFICATIONS

Technical Data:	All technical data relate to an ambient temperature of +25°C						
Capacitance Range:	1.0µF to 68µF						
Capacitance Tolerance:	±10%; ±20%						
Leakage Current DCL:	0.01CV or 0.5µA whichever is the greater						
Rated Voltage (V <sub>R</sub> )	≧ +85°C:	2	3	4	6.3	10	16
Category Voltage (V <sub>C</sub> )	≧ +125°C:	1.3	2	2.7	4	7	10
Surge Voltage (V <sub>S</sub> )	≧ +85°C:	2.7	3.9	5.2	8	13	20
Surge Voltage (V <sub>S</sub> )	≧ +125°C:	1.7	2.6	3.2	5	8	12
Temperature Range:	-55°C to +125°C						
Reliability:	1% per 1000 hours at 85°C, V with 0.1Ω/V series impedance, 60% confidence level						
Termination Finish:	Nickel and Tin Plating (standard), Nickel and Gold Plating option available upon request						

## Low Profile

### LOW PROFILE & CUSTOM RANGE

(LETTER DENOTES CASE SIZE)

Capacitance		Voltage Rating DC (V <sub>R</sub> ) at 85°C					
Cap. (µF)	Code	2.0V	3.0V	4.0V	6.3V	10V	16V
0.33 0.47 0.68	334 474 684						
1.0 1.5 2.2	105 155 225				N	U	U
3.3 4.7 6.8	335 475 685			U	U U		
10 15 22	106 156 226	U			H H	H	
33 47 68	336 476 686		H X	H	T	T	
100 150 220	107 157 227				T		
330 470 680	107 157 227						

Developmental Ratings - subject to change

### RATINGS & PART NUMBER REFERENCE

AVX Part No.	EIA	Case Size	Capacitance (µF)	Rated Voltage (V)	DCL (µA) Max.	DF % Max.	ESR Max. (Ω) @100kHz
TACN105M006#	0402	N	1.0	6.3	0.5	8	20
TACU106M002#	0805	U	10	2.0	0.5	8	5
TACU475M004#	0805	U	4.7	4.0	0.5	8	5
TACU335M006#	0805	U	3.3	6.3	0.5	8	5
TACU225M010#	0805	U	2.2	10.0	0.5	8	5
TACU105M016#	0805	U	1.0	16.0	0.5	8	5
TACH476M003#	0805	H	47	3.0	1.5	14	5
TACH336M004#	0805	H	33	4.0	1.3	14	5
TACH156*006#	0805	H	15	6.3	0.9	8	5
TACH226*006#	0805	H	22	6.3	1.4	10	5
TACH106M010#	0805	H	10	10.0	1.0	8	5
TACT476M010#	3528-12**	T	47	10.0	4.7	10	1
TACT686M006#	3528-12**	T	68	6.3	4.3	12	1
TACT107M006#	3528-12**	T	100	6.3	6.3	12	1
TACX686*003#	special	X	68	3.0	1.5	12	1

Developmental Ratings - subject to change

All technical data relates to an ambient temperature of +25°C. Capacitance and DF are measured at 120Hz, 0.5V RMS with a maximum DC bias of 2.2 volts. DCL is measured at rated voltage after 5 minutes.

\* Insert K for ±10% and M for ±20% Capacitance Tolerance

# Refer to packaging suffix for options

**NOTE: AVX reserves the right to supply a higher voltage rating or tighter tolerance part in the same case size, to the same reliability standards.**

\*\* EIA Metric

Standard Height Profile: K, L, R, A Case

Low Profile: N, U, H, T, W Case

Custom Low Profile: X Case

# TAK Series



## Low Profile - Performance TACmicrochip™



### KEY FEATURES

Building on the miniature substrate design concept of the TACmicrochip™ product, a new TAK™ construction has been developed to enable higher CV offerings (in excess of 100µF at 6V) in a low profile format.

Profile height for the 100µF at 6.3V product will be 1.0mm and the 150µF-220µF will be 1.2mm max. This product is configured as a two-terminal device.

The substrate top plate allows for efficient dissipation of heat thus improving ripple current handling capabilities.

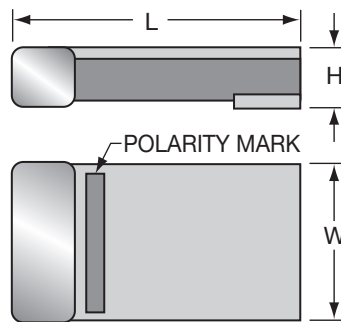

### DIMENSIONS: millimeters (inches)

Case Code	EIA Metric	Length	Width	Height Max.
W	7343-25	7.30 (0.287)	4.30 (0.169)	2.50 (0.098)
Y	7343-20	7.30 (0.287)	4.30 (0.169)	2.00 (0.079)
X	7343-15	7.30 (0.287)	4.30 (0.169)	1.50 (0.059)
F	7343-12	7.30 (0.287)	4.30 (0.169)	1.20 (0.047)
H	7343-10	7.30 (0.287)	4.30 (0.169)	1.00 (0.039)

All TAK products based on "D" case footprint

### COMMERCIAL RANGE (LETTER DENOTES CASE SIZE)

Capacitance		Voltage Rating DC (V <sub>R</sub> ) at 85°C				
Cap. (µF)	Code	3.0V	4.0V	6.3V	10V	16V
33	336					
47	476				H	
68	686			H	H	F
100	107		H	H	F	X
150	157	H	H	F	X	
220	227	H	F	X		
330	337	F	X		Y	
470	477	X		Y	W	
680	687		Y	W		
1000	108	Y	W			
1500	158	W				
2200	228					

Developmental Ratings - subject to change

### RATINGS & PART NUMBER REFERENCE

AVX Part No.	EIA	Case Size	Capacitance (µF)	Rated Voltage (V)	DCL (µA) Max.	DF % Max.	ESR Max. (mΩ) @100kHz
TAKH107M006#	7343-10	H	100	6.3	6.3	12	200
TAKF157M006#	7343-12	F	150	6.3	9.5	12	200
TAKX227M006#	7343-15	X	220	6.3	13.9	12	200
TAKY108M003#	7343-20	Y	1000	3.0	30	20	100

Items highlighted in red are subject to technical specification change.



# TPS Series



## Low ESR



TPS surface mount products have inherently low ESR (equivalent series resistance) and are capable of higher ripple current handling, producing lower ripple voltages, less power and heat dissipation than standard product for the most efficient use of circuit power. TPS has been designed, manufactured, and preconditioned for

optimum performance in typical power supply applications. By combining the latest improvements in tantalum powder technology, improved manufacturing processes, and application specific preconditioning tests, AVX is able to provide a technologically superior alternative to the standard range.

### CASE DIMENSIONS: millimeters (inches)

Code	EIA Code	Dimension Low Profile	L±0.20 (0.008)	W+0.20 (0.008) -0.10 (0.004)	H+0.20 (0.008) -0.10 (0.004)	W <sub>1</sub> ±0.20 (0.008)	A+0.30 (0.012) -0.20 (0.008)	S Min.
A	3216-18	-	3.20 (0.126)	1.60 (0.063)	1.60 (0.063)	1.20 (0.047)	0.80 (0.031)	1.10 (0.043)
B	3528-21	-	3.50 (0.138)	2.80 (0.110)	1.90 (0.075)	2.20 (0.087)	0.80 (0.031)	1.40 (0.055)
C	6032-28	-	6.00 (0.236)	3.20 (0.126)	2.6 (0.102)	2.20 (0.087)	1.30 (0.051)	2.90 (0.114)
D	7343-31	-	7.30 (0.287)	4.30 (0.169)	2.90 (0.114)	2.40 (0.094)	1.30 (0.051)	4.40 (0.173)
E	7343-43	-	7.30 (0.287)	4.30 (0.169)	4.10 (0.162)	2.40 (0.094)	1.30 (0.051)	4.40 (0.173)
P*	2012-15	-	2.05 (0.081)	1.35 (0.053)	1.50 (0.059) max.	1.0 ±0.1 (0.039±0.004)	0.50 (0.020)	0.85 (0.033)
R*	2012-12	R Case (1.20)	2.05 (0.081)	1.30 (0.051)	1.20 (0.047) max.	1.0 ±0.1 (0.039±0.004)	0.50 (0.020)	0.85 (0.033)
S**	3216-12	A Case (1.20)	3.20 (0.126)	1.60 (0.063)	1.20 (0.047) max.	1.20 (0.047)	0.80 (0.031)	1.10 (0.043)
T**	3528-12	B Case (1.20)	3.50 (0.138)	2.80 (0.110)	1.20 (0.047) max.	2.20 (0.087)	0.80 (0.031)	1.40 (0.055)
V	7361-38	-	7.30 (0.287)	6.10 (0.240)	3.45 ±0.30 (0.136 ±0.012)	3.10 (0.120)	1.40 (0.055)	4.40 (0.173)
W**	6032-15	C Case (1.50)	6.00 (0.236)	3.20 (0.126)	1.50 (0.059) max.	2.20 (0.087)	1.30 (0.051)	2.90 (0.114)
X**	7343-15	D Case (1.50)	7.30 (0.287)	4.30 (0.169)	1.50 (0.059) max.	2.40 (0.094)	1.30 (0.051)	4.40 (0.173)
Y**	7343-20	D Case (2.00)	7.30 (0.287)	4.30 (0.169)	2.00 (0.079) max.	2.40 (0.094)	1.30 (0.051)	4.40 (0.173)

W<sub>1</sub> dimension applies to the termination width for A dimensional area only.

\* 0805 Footprint Compatible \*\* Low Profile Versions of A & B & C & D Case

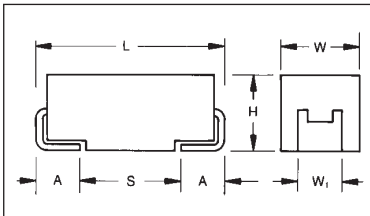

For part marking see page 121

### HOW TO ORDER

TPS

Type

C

Case Size  
See table above

107

Capacitor Code  
pF code: 1st two digits represent significant figures, 3rd digit represents multiplier (number of zeros to follow)

M

Tolerance  
K = ±10%  
M = ±20%

010

Rated DC Voltage  
002 = 2.5Vdc  
004 = 4Vdc  
006 = 6.3Vdc  
010 = 10Vdc  
016 = 16Vdc  
020 = 20Vdc  
025 = 25Vdc  
035 = 35Vdc  
050 = 50Vdc

R

Packaging  
R = 7" T/R  
(Lead Free since production date 1/1/04)  
S = 13" T/R  
(Lead Free since production date 1/1/04)  
A = Gold Plating  
7" Reel  
B = Gold Plating  
13" Reel

0100

Maximum ESR in Milliohms  
See note below

NOTE: The EIA & CECC standards for low ESR Solid Tantalum Capacitors allow an ESR movement to 1.25 times catalog limit post mounting.

### TECHNICAL SPECIFICATIONS

Technical Data:	All technical data relate to an ambient temperature of +25°C									
Capacitance Range:	0.15µF to 1500µF									
Capacitance Tolerance:	±10%; ±20%									
Rated Voltage (V <sub>R</sub> )	≤ +85°C:	2.5	4	6.3	10	16	20	25	35	50
Category Voltage (V <sub>C</sub> )	≤ +125°C:	1.7	2.7	4	7	10	13	17	23	33
Surge Voltage (V <sub>S</sub> )	≤ +85°C:	3.3	5.2	8	13	20	26	32	46	65
Surge Voltage (V <sub>S</sub> )	≤ +125°C:	2.2	3.4	5	8	13	16	20	28	40
Temperature Range:	-55°C to +125°C									
Environmental Classification:	55/125/56 (IEC 68-2)									
Reliability:	1% per 1000 hours at 85°C, V <sub>R</sub> with 0.1Ω/V series impedance, 60% confidence level									
	Meets requirements of AEC-Q200									



### CAPACITANCE AND RATED VOLTAGE, $V_R$ (VOLTAGE CODE) RANGE (LETTER DENOTES CASE SIZE)

Capacitance		Rated Voltage DC ( $V_R$ ) to 85°C								
$\mu\text{F}$	Code	2.5V (e)	4V (G)	6.3V (J)	10V (A)	16V (C)	20V (D)	25V (E)	35V (V)	50V (T)
0.15	154									A(9000)
0.22	224								A(6000)	A(7000)
0.33	334								A(6000)	
0.47	474							A(7000)	A(6000) B(4000)	
0.68	684							A(6000)	A(6000)	
1	105				R(9000)		A(3000), R(6000) S(6000), T(2000)		A(3000) B(2000)	C(2500)
1.5	155							A(3000) B(1800)	B(2500)	C(1500,2000)
2.2	225			R(7000)	A(1800)	A(1800,3500) T(2000)	A(3000)	B(900,1200,2500)	A(1500), B(750, 1500,2000), C(1000)	D(1200)
3.3	335				T(1500)	A(3500)	A(2500) B(1300)	A(1000,1500) B(750,1500,2000)	B(1000) C(700)	D(800)
4.7	475			S(4000)	A(1400) R(3000,5000)	A(2000) B(800,1500)	A(1800) B(750,1000)	B(700,900,1500)	B(700,1500) C(600)	D(300,500,700)
6.8	685			A(1800)	A(1800) T(1800)	A(1500) B(600,1200)	A(1000) B(600,1000) C(700)	B(700) C(500,600,700)	C(350) D(150,400,500)	D(300,500,600)
10	106		R(3000)	A(1500) R(1000,1500,3000)	A(900,1800) P(2000) <sup>M</sup> T(1000,2000)	B(500,800), C(500) T(800,1000) W(500,600)	B(500,1000) C(500,700)	C(300,500)	D(125,300) E(200)	E(400,500)
15	156			A(700,1500)	A(1000) B(450,600)	B(500,800)	B(500) C(400,450)	C(220,300) D(100,300)	C(350,450) D(100,300) Y(250)	E(250)
22	226			A(500,900) B(375,600) S(900)	B(400,500,700) C(300) T(800)	B(400,600) C(150,250,300,375) W(500)	B(400,600) C(100,150,400) D(200,300)	C(275,400) D(100,200,300)	D(125,200, 300,400) E(125,200,300)	
33	336			A(600) B(250,350,450,600) T(800)	B(250,425,500,650) C(150,375,500) W(350)	B(350,500) C(100,150,225,300) D(200), W(140,175, 250,400,500) Y(300,400)	C(300) D(100,200)	D(100,200,300) E(100,175, 200,300)	D(200,300) E(100,250,300) V(200)	
47	476		A(500)	A(800) B(250,350,500) C(300)	B(250,350,500,650) C(200,350) D(100) W(125,150,250)	C(110,350) D(80,100, 150,200) W(200) Y(250), X(180)	D(75,100,200) E(70,125,150, 200,250)	D(125,150,250) E(80,100,125)	E(200,250) V(150,200)	
68	686			B(250,350,500) C(150,200) W(110,125,250)	B(600) C(80,100,200,300) D(100,150), Y(100,200) W(100,150)	C(125,200) D(70,100,150) Y(200,250), X(150)	D(70,150, 200,300) E(125,150,200)	E(125,200) V(80,95,150,200)	V(150,200) <sup>M</sup>	
100	107	B(200)	B(200,250, 350,500) W(100)	B(250,400) C(75,150) Y(100) W(100)	B(400) <sup>M</sup> C(75,100,150,200) D(50,65,80,100,125, 150) E(125) W(150) X(85,150,200) Y(100,150,200)	D(60,100, 125,150) E(55,100, 125,150)	D(85,100,150) E(100,150,200) V(60,85,100,200)	V(100)		
150	157	B(150)	B(250) C(70,80)	C(50,90,150,200,250) D(50,125), Y(40)	D(50,85,100), E(100) X(100) <sup>M</sup> , Y(100,150,200)	D(60,85,100,125,150) E(100), V(45,75)	V(80)			
220	227	B(150, 200,600) D(45)	D(40,50,100) Y(40)	C(70,100,125,250) D(50,100,125) E(100) Y(100,150)	D(50,100,150) E(50,60,70,100, 125,150) Y(150,200)	E(100,150) V(50,75, 100,150)				
330	337	Y(40)	C(100) D(35,45,100) X(100)	D(45,50,70,100) E(50,100,125,150) V(100), Y(150)	D(50,65,100,150) E(40,50,60,100) V(40,60,100)					
470	477	D(35) Y(100)	D(45,100) E(35,45,100)	D(45,60,100,200) E(45,50,60,100,200) V(40,55,100)	E(45,50,60,100,200) V(40,60,100)					
680	687	D(35,50) E(35,50) Y(100)	D(45,60,100) E(40,60,100)	E(45,60,100) V(35,40,50)						
1000	108	E(30,40) Y(100) <sup>M</sup>	E(60) V(25,35,40,50)	V(40,50) <sup>M</sup>						
1500	158	E(50) V(30,40)	E(50,75) V(50,75) <sup>M</sup>							

For C, D and E case ratings in TPS Series, ESR ratings are printed on capacitor side in the following format:  
T x x x -where x x x is ESR limit in milliohms i.e. T100 represents max. ESR of 100 milliohms.

ESR limits quoted in brackets (milliohms)

Released codes <sup>M</sup> tolerance only

**NOTE: The EIA & CECC standards for low ESR Solid Tantalum Capacitors allow an ESR movement to 1.25 times catalog limit post mounting.**

















### RATINGS & PART NUMBER REFERENCE

AVX Part No.	Case Size	Capacitance (μF)	Rated Voltage (V)	DCL (μA) Max.	DF % Max.	ESR Max. (mΩ) @100kHz	100kHz Ripple Current Ratings (A)			100kHz Ripple Voltage Ratings (V)		
							25°C	85°C	125°C	25°C	85°C	125°C
TPSE226*035#0300	E	22	35	7.7	6	300	0.742	0.667	0.297	0.222	0.200	0.089
TPSD336*035#0200	D	33	35	11.6	6	200	0.866	0.779	0.346	0.173	0.156	0.069
TPSD336*035#0300	D	33	35	11.6	6	300	0.707	0.636	0.283	0.212	0.191	0.085
TPSE336*035#0100	E	33	35	11.6	6	100	1.285	1.156	0.514	0.128	0.116	0.051
TPSE336*035#0250	E	33	35	11.6	6	250	0.812	0.731	0.325	0.203	0.183	0.081
TPSE336*035#0300	E	33	35	11.6	6	300	0.742	0.667	0.297	0.222	0.200	0.089
TPSV336*035#0200	V	33	35	11.6	6	200	1.118	1.006	0.447	0.224	0.201	0.089
TPSE476*035#0200	E	47	35	16.5	6	200	0.908	0.817	0.363	0.182	0.163	0.073
TPSE476*035#0250	E	47	35	16.5	6	250	0.812	0.731	0.325	0.203	0.183	0.081
TPSV476*035#0150	V	47	35	16.5	6	150	1.291	1.162	0.516	0.194	0.174	0.077
TPSV476*035#0200	V	47	35	16.5	6	200	1.118	1.006	0.447	0.224	0.201	0.089
TPSV686M035#0150	V	68	35	23.8	6	150	1.291	1.162	0.516	0.194	0.174	0.077
TPSV686M035#0200	V	68	35	23.8	6	200	1.118	1.006	0.447	0.224	0.201	0.089
TPSA154*050#9000	A	0.15	50	0.5	4	9000	0.091	0.082	0.037	0.822	0.739	0.329
TPSA224*050#7000	A	0.22	50	0.5	4	7000	0.104	0.093	0.041	0.725	0.652	0.290
TPSC105*050#2500	C	1	50	0.5	4	2500	0.210	0.189	0.084	0.524	0.472	0.210
TPSC155*050#1500	C	1.5	50	0.8	6	1500	0.271	0.244	0.108	0.406	0.366	0.162
TPSC155*050#2000	C	1.5	50	0.8	6	2000	0.235	0.211	0.094	0.469	0.422	0.188
TPSD225*050#1200	D	2.2	50	1.1	6	1200	0.354	0.318	0.141	0.424	0.382	0.170
TPSD335*050#0800	D	3.3	50	1.7	6	800	0.433	0.390	0.173	0.346	0.312	0.139
TPSD475*050#0300	D	4.7	50	2.4	6	300	0.707	0.636	0.283	0.212	0.191	0.085
TPSD475*050#0500	D	4.7	50	2.4	6	500	0.548	0.493	0.219	0.274	0.246	0.110
TPSD475*050#0700	D	4.7	50	2.4	6	700	0.463	0.417	0.185	0.324	0.292	0.130
TPSD685*050#0300	D	6.8	50	3.4	6	300	0.707	0.636	0.283	0.212	0.191	0.085
TPSD685*050#0500	D	6.8	50	3.4	6	500	0.548	0.493	0.219	0.274	0.246	0.110
TPSD685*050#0600	D	6.8	50	3.4	6	600	0.500	0.450	0.200	0.300	0.270	0.120
TPSE106*050#0400	E	10	50	5	6	400	0.642	0.578	0.257	0.257	0.231	0.103
TPSE106*050#0500	E	10	50	5	6	500	0.574	0.517	0.230	0.287	0.259	0.115
TPSE156*050#0250	E	15	50	5	6	250	0.812	0.731	0.325	0.203	0.183	0.081

All technical data relates to an ambient temperature of +25°C.  
 Capacitance and DF are measured at 120Hz, 0.5V RMS with a maximum DC bias of 2.2 volts. DCL is measured at rated voltage after 5 minutes.  
 \* Insert K for ±10% and M for ±20% Capacitance Tolerance

# **Standard Plating** – Insert R for 7" reel and S for 13" reel  
 # **Gold Plating** – Insert A for 7" reel and B for 13" reel

# TPS Series III

## New Generation Low ESR

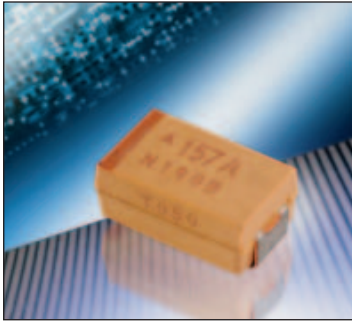

Current application trends in circuit designs for switch-mode power supplies, micro-processors, and digital circuits call for higher operating frequencies and smoother filtering. In order to function properly, components with low ESR, high capacitance and high reliability are required. The New Third generation TPS Low ESR series is based on the traditional MnO<sub>2</sub> process

that offers very low ESR levels previously only seen by other technologies. Further, continuous improvements in MnO<sub>2</sub> technology has allowed reductions in the resistance of the capacitor electrodes in order to further reduce ESR levels. Traditional MnO<sub>2</sub> technology guarantees excellent line and field performance, humidity stability and high electrical and thermal stress resistance.

### CASE DIMENSIONS: millimeters (inches)

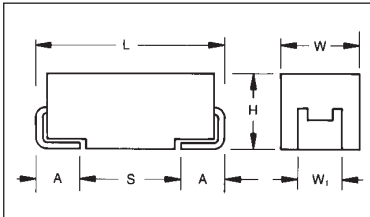

For part marking see page 121

Code	EIA Code	L±0.20 (0.008)	W+0.20 (0.008) -0.10 (0.004)	H+0.20 (0.008) -0.10 (0.004)	W <sub>1</sub> ±0.20 (0.008)	A+0.30 (0.012) -0.20 (0.008)	S Min.
B	3528-21	3.50 (0.138)	2.80 (0.110)	1.90 (0.075)	2.20 (0.087)	0.80 (0.031)	1.40 (0.055)
C	6032-28	6.00 (0.236)	3.20 (0.126)	2.60 (0.102)	2.20 (0.087)	1.30 (0.051)	2.90 (0.114)
D	7343-31	7.30 (0.287)	4.30 (0.169)	2.90 (0.114)	2.40 (0.094)	1.30 (0.051)	4.40 (0.173)
E	7343-43	7.30 (0.287)	4.30 (0.169)	4.10 (0.162)	2.40 (0.094)	1.30 (0.051)	4.40 (0.173)
V	7361-38	7.30 (0.287)	6.10 (0.240)	3.45±0.30 (0.136±0.012)	3.10 (0.120)	1.40 (0.055)	4.40 (0.173)
W*	6032-15	6.00 (0.236)	3.20 (0.126)	1.50 (0.059) max.	2.20 (0.087)	1.30 (0.051)	2.90 (0.114)
Y**	7343-20	7.30 (0.287)	4.30 (0.169)	2.00 (0.079) max.	2.40 (0.094)	1.30 (0.051)	4.40 (0.173)

W<sub>1</sub> dimension applies to the termination width for A dimensional area only.

\* Low Profile Version of C Case (max. height 1.5 [0.059])

\*\* Low Profile Version of D Case (max. height 2.0 [0.079])

### HOW TO ORDER

**TPS**

Type

**D**

Case Size  
See table above

**227**

Capacitor Code  
pF code: 1st two digits represent significant figures, 3rd digit represents multiplier (number of zeros to follow)

**K**

Capacitance Tolerance  
K=±10%  
M=±20%

**010**

Rated DC Voltage  
002=2.5Vdc  
004=4Vdc  
006=6.3Vdc  
010=10Vdc  
016=16Vdc  
020=20Vdc  
025=25Vdc  
035=35Vdc  
050=50Vdc

**R**

Packaging  
R = 7" T/R  
(Lead Free since production date 1/1/04)  
S = 13" T/R  
(Lead Free since production date 1/1/04)  
A = Gold Plating  
7" Reel  
B = Gold Plating  
13" Reel

**0050**

Maximum ESR in Milliohms  
See note below

**NOTE:** The EIA & CECC standards for low ESR Solid Tantalum Capacitors allow an ESR movement to 1.25 times catalog limit post mounting.

### TECHNICAL SPECIFICATIONS

Technical Data:

All technical data relate to an ambient temperature of +25°C

Capacitance Range: 4.7µF to 1500µF

Capacitance Tolerance: ±10%; ±20%

Rated Voltage (V <sub>R</sub> )	≤ +85°C:	2.5	4	6.3	10	16	20	25	35	50
Category Voltage (V <sub>C</sub> )	≤ +125°C:	1.7	2.7	4	7	10	13	17	23	33
Surge Voltage (V <sub>S</sub> )	≤ +85°C:	3.3	5.2	8	13	20	26	32	46	65
Surge Voltage (V <sub>S</sub> )	≤ +125°C:	2.2	3.4	5	8	13	16	20	28	40

Temperature Range: -55°C to +125°C

Environmental Classification: 55/125/56 (IEC 68-2)

Reliability: 1% per 1000 hours at 85°C, V<sub>R</sub> with 0.1/V series impedance, 60% confidence level

Meets requirements of AEC-Q200





# TPS Series III



## New Generation Low ESR

**CAPACITANCE AND RATED VOLTAGE,  $V_R$  (VOLTAGE CODE) RANGE  
LETTER DENOTES CASE SIZE (ESR in m $\Omega$ )**

### SERIES III MATRIX

Capacitance		Rated Voltage DC ( $V_R$ ) to 85°C								
$\mu$ F	Code	2.5V (e)	4V (G)	6.3V (J)	10V (A)	16V (C)	20V (D)	25V (E)	35V (V)	50V (T)
4.7	475									D(300)
6.8	685									
10	106								D(125)	
15	156							D(100)	D(100)	
22	226					C(150)	C(100)	D(100)	D(125) E(125)	
33	336				C(150)	W(140)	D(100)	D(100) E(100)	D(200) E(100) V(80)	
47	476			B(250)	W(125)	D(80)	D(75) E(70)	E(80)	V(100)	
68	686			W(110)	Y(70,100)	D(70)	D(70)	E(125) V(80)		
100	107			C(75) Y(65,100)	C(75) D(50) Y(65,100)	D(60) E(55) Y(65,100)	V(60)			
150	157			D(50)	D(50) Y(65,100)	E(50) V(45)				
220	227	D(45)	D(40)	D(50) Y(65,100)	D(50) E(50)	V(45,50)				
330	337		D(35)	D(45)	E(40) V(40)					
470	477		D(45) E(35)	E(45)	E(45) V(40)					
680	687		E(40)	E(45) V(35)						
1000	108	E(30)	V(25) E(40)							
1500	158	V(30)								

Red - Developmental Ratings - subject to change

For TPS series and the case sizes C, D and E the ESR limits are printed on capacitor side in the following format:

T x x x - where x x x is ESR limit in milliohms i.e. T100 represents max. ESR of 100 milliohms.

ESR limits quoted in brackets (milliohms)

**NOTE: The EIA & CECC standards for low ESR Solid Tantalum Capacitors allow an ESR movement to 1.25 times catalog limit post mounting.**

# TPS Series III



## New Generation Low ESR

### RATINGS & PART NUMBER REFERENCE

AVX Part No.	Case Size	Capacitance (μF)	Rated Voltage (V)	DCL (μA) Max.	DF % Max.	ESR Max. (mΩ) @100kHz	100kHz Ripple Current Ratings (A)			100kHz Ripple Voltage Ratings (V)		
							25°C	85°C	125°C	25°C	85°C	125°C
TPSD227*002#0045	D	220	2.5	4.4	8	45	1.826	1.643	0.730	0.082	0.074	0.033
TPSE108*002#0030	E	1000	2.5	20	14	30	2.345	2.111	0.938	0.070	0.063	0.028
TPSV158*002#0030	V	1500	2.5	30	20	30	2.887	2.598	1.155	0.087	0.078	0.035
TPSD227*004#0040	D	220	4	8.8	8	40	1.936	1.743	0.775	0.077	0.070	0.031
TPSD337*004#0035	D	330	4	13.2	8	35	2.070	1.863	0.828	0.072	0.065	0.029
TPSD477*004#0045	D	470	4	18.8	12	45	1.826	1.643	0.730	0.082	0.074	0.033
TPSE477*004#0035	E	470	4	18.8	10	35	2.171	1.954	0.868	0.076	0.068	0.030
TPSE687*004#0040	E	680	4	27.2	10	40	2.031	1.828	0.812	0.081	0.073	0.032
TPSV108*004#0025	V	1000	4	40	16	25	3.162	2.846	1.265	0.079	0.071	0.032
TPSB476*006#0250	B	47	6.3	3	6	250	0.583	0.525	0.233	0.146	0.131	0.058
TPSW686*006#0110	W	68	6.3	4.3	6	110	0.905	0.814	0.362	0.099	0.090	0.040
TPSC107*006#0075	C	100	6.3	6.3	6	75	1.211	1.090	0.484	0.091	0.082	0.036
TPSY107*006#0100	Y	100	6.3	6.3	6	100	1.118	1.006	0.447	0.112	0.101	0.045
TPSD157*006#0050	D	150	6.3	9.5	6	50	1.732	1.559	0.693	0.087	0.078	0.035
TPSD227*006#0050	D	220	6.3	13.9	8	50	1.732	1.559	0.693	0.087	0.078	0.035
TPSY108*006#0100	Y	220	6.3	13.9	10	100	1.118	1.006	0.447	0.112	0.101	0.045
TPSD337*006#0045	D	330	6.3	20.8	8	45	1.826	1.643	0.730	0.082	0.074	0.033
TPSE477*006#0045	E	470	6.3	29.6	10	45	1.915	1.723	0.766	0.086	0.078	0.034
TPSE687*006#0045	E	680	6.3	42.8	10	45	1.915	1.723	0.766	0.086	0.078	0.034
TPSV687*006#0035	V	680	6.3	42.8	14	35	2.673	2.405	1.069	0.094	0.084	0.037
TPSC336*010#0150	C	33	10	3.3	6	150	0.856	0.771	0.343	0.128	0.116	0.051
TPSW476*010#0125	W	47	10	4.7	6	125	0.849	0.764	0.339	0.106	0.095	0.042
TPSY686*010#0100	Y	68	10	6.8	6	100	1.118	1.006	0.447	0.112	0.101	0.045
TPSC107*010#0075	C	100	10	10	8	75	1.211	1.090	0.484	0.091	0.082	0.036
TPSD107*010#0050	D	100	10	10	6	50	1.732	1.559	0.693	0.087	0.078	0.035
TPSY107*010#0100	Y	100	10	10	6	100	1.118	1.006	0.447	0.112	0.101	0.045
TPSD157*010#0050	D	150	10	15	6	50	1.732	1.559	0.693	0.087	0.078	0.035
TPSY157*010#0100	Y	150	10	15	6	100	1.118	1.006	0.447	0.112	0.101	0.045
TPSD227*010#0050	D	220	10	22	8	50	1.732	1.559	0.693	0.087	0.078	0.035
TPSE227*010#0050	E	220	10	22	8	50	1.817	1.635	0.727	0.091	0.082	0.036
TPSE337*010#0040	E	330	10	33	8	40	2.031	1.828	0.812	0.081	0.073	0.032
TPSV337*010#0040	V	330	10	33	10	40	2.500	1.250	1.000	0.100	0.090	0.040
TPSE477*010#0045	E	470	10	47	10	45	1.915	1.723	0.766	0.086	0.078	0.034
TPSV477*010#0040	V	470	10	47	10	40	2.500	2.250	1.000	0.100	0.090	0.040
TPSC226*016#0150	C	22	16	3.5	6	150	0.856	0.771	0.343	0.128	0.116	0.051
TPSW336*016#0140	W	33	16	5.3	6	140	0.802	0.722	0.321	0.112	0.101	0.045
TPSD476*016#0080	D	47	16	7.5	6	80	1.369	1.232	0.548	0.110	0.099	0.044
TPSD686*016#0070	D	68	16	10.8	6	70	1.464	1.317	0.586	0.102	0.092	0.041
TPSD107*016#0060	D	100	16	16	6	60	1.581	1.423	0.632	0.095	0.085	0.038
TPSE107*016#0055	E	100	16	16	6	55	1.732	1.559	0.693	0.095	0.086	0.038
TPSY107*016#0100	Y	100	16	16	8	100	1.118	1.006	0.447	0.112	0.101	0.045
TPSV157*016#0045	V	150	16	24	6	45	2.357	2.121	0.943	0.106	0.095	0.042
TPSV227*016#0050	V	220	16	35.2	8	50	2.236	2.012	0.894	0.112	0.101	0.045

All technical data relates to an ambient temperature of +25°C.  
 Capacitance and DF are measured at 120Hz, 0.5V RMS with a maximum DC bias of 2.2 volts. DCL is measured at rated voltage after 5 minutes.  
 \* Insert K for ±10% and M for ±20% Capacitance Tolerance

# Standard Plating – Insert R for 7" reel and S for 13" reel  
 # Gold Plating – Insert A for 7" reel and B for 13" reel

**NOTE: AVX reserves the right to supply a higher voltage rating or tighter tolerance part in the same case size, to the same reliability standards.**



# TPS Series III

## New Generation Low ESR



### RATINGS & PART NUMBER REFERENCE

AVX Part No.	Case Size	Capacitance (μF)	Rated Voltage (V)	DCL (μA) Max.	DF % Max.	ESR Max. (mΩ) @100kHz	100kHz Ripple Current Ratings (A)			100kHz Ripple Voltage Ratings (V)		
							25°C	85°C	125°C	25°C	85°C	125°C
TPSC226*020#0100	C	22	20	4.4	6	100	1.049	0.944	0.420	0.105	0.094	0.042
TPSD336*020#0100	D	33	20	6.6	6	100	1.225	1.102	0.490	0.122	0.110	0.049
TPSD476*020#0075	D	47	20	9.4	6	75	1.414	1.273	0.566	0.106	0.095	0.042
TPSE476*020#0070	E	47	20	9.4	6	70	1.535	1.382	0.614	0.107	0.097	0.043
TPSD686*020#0070	D	68	20	13.6	6	70	1.464	1.317	0.586	0.102	0.092	0.041
TPSV107*020#0060	V	100	20	20	8	60	2.041	1.837	0.816	0.122	0.110	0.049
TPSD156*025#0100	D	15	25	3.8	6	100	1.225	1.102	0.490	0.122	0.110	0.049
TPSD226*025#0100	D	22	25	5.5	6	100	1.225	1.102	0.490	0.122	0.110	0.049
TPSD336*025#0100	D	33	25	8.3	6	100	1.225	1.102	0.490	0.122	0.110	0.049
TPSE336*025#0100	E	33	25	8.3	6	100	1.285	1.156	0.514	0.128	0.116	0.051
TPSE476*025#0080	E	47	25	8.3	6	80	1.436	1.293	0.574	0.115	0.103	0.046
TPSE686*025#0125	E	68	25	17	6	125	1.149	1.034	0.460	0.144	0.129	0.057
TPSV686*025#0080	V	68	25	17	6	80	1.768	1.591	0.707	0.141	0.127	0.057
TPSD106*035#0125	D	10	35	3.5	6	125	1.095	0.986	0.438	0.137	0.123	0.055
TPSD156*035#0100	D	15	35	5.3	6	100	1.225	1.102	0.490	0.122	0.110	0.049
TPSD226*035#0125	D	22	35	7.7	6	125	1.095	0.986	0.438	0.137	0.123	0.055
TPSE226*035#0125	E	22	35	7.7	6	125	1.149	1.034	0.460	0.144	0.129	0.057
TPSD336*035#0200	D	33	35	11.6	6	200	0.866	0.779	0.346	0.173	0.156	0.069
TPSE336*035#0100	E	33	35	11.6	6	100	1.285	1.156	0.514	0.128	0.116	0.051
TPSD475*050#0300	D	4.7	50	2.4	6	300	0.707	0.636	0.283	0.212	0.191	0.085

All technical data relates to an ambient temperature of +25°C.  
 Capacitance and DF are measured at 120Hz, 0.5V RMS with a maximum DC bias of 2.2 volts. DCL is measured at rated voltage after 5 minutes.

\* Insert K for ±10% and M for ±20% Capacitance Tolerance

# **Standard Plating** – Insert R for 7" reel and S for 13" reel  
 # **Gold Plating** – Insert A for 7" reel and B for 13" reel

**NOTE: AVX reserves the right to supply a higher voltage rating or tighter tolerance part in the same case size, to the same reliability standards.**



# TPM Multianode

## Tantalum Ultra Low ESR Capacitor

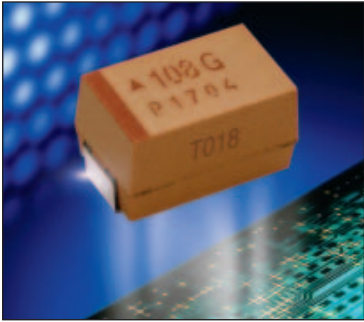

Low ESR, high capacitance and high ripple current are the key parameters for processor filtering. Multianode configuration within a standard E case package meets these requirements. Parameters such as ESR

15mΩ, capacitance 1500μF and ripple current above 4A rms makes TPM series ready to use with the latest processor families.

### CASE DIMENSIONS: millimeters (inches)

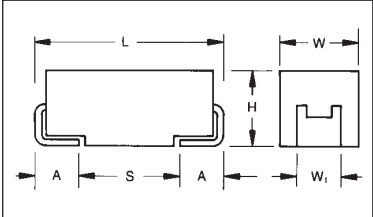

Code	EIA Code	L±0.20 (0.008)	W+0.20 (0.008) -0.10 (0.004)	H+0.20 (0.008) -0.10 (0.004)	W <sub>1</sub> ±0.20 (0.008)	A+0.30 (0.012) -0.20 (0.008)	S Min.
E	7343-43	7.30 (0.287)	4.30 (0.169)	4.10 (0.162)	2.40 (0.094)	1.30 (0.051)	4.40 (0.173)
V	7361-38	7.30 (0.287)	6.10 (0.240)	3.45 ±0.30 (0.136 ±0.012)	3.10 (0.120)	1.40 (0.055)	4.40 (0.173)

W<sub>1</sub> dimension applies to the termination width for A dimensional area only.

For part marking see page 121

### HOW TO ORDER

**TPM**  
Type

**E**  
Case Size  
See table above

**108**  
Capacitance Code  
pF code: 1st two digits represent significant figures, 3rd digit represents multiplier (number of zeros to follow)

**\***  
Capacitance Tolerance  
K=±10%  
M=±20%

**004**  
Rated DC Voltage  
002=2.5Vdc  
004=4Vdc  
006=6.3Vdc  
010=10Vdc  
016=16Vdc  
020=20Vdc  
025=25Vdc  
035=35Vdc  
050=50Vdc

**R**  
Packaging  
R = 7" T/R  
Lead Free  
S = 13" T/R  
Lead Free

**0018**  
Maximum ESR in Milliohms  
See note below

**NOTE:** The EIA & CECC standards for low ESR Solid Tantalum Capacitors allow an ESR movement to 1.25 times catalog limit post mounting.

### TECHNICAL SPECIFICATIONS

Technical Data:	All technical data relate to an ambient temperature of +25°C									
Capacitance Range:	10μF to 1500μF									
Capacitance Tolerance:	±10%, ±20%									
Rated Voltage (V <sub>R</sub> )	≤ +85°C:	2.5	4	6.3	10	16	20	25	35	50
Category Voltage (V <sub>C</sub> )	≤ +125°C:	1.7	2.7	4	7	10	13	17	23	33
Surge Voltage (V <sub>S</sub> )	≤ +85°C:	3.3	5.2	8	13	20	26	32	46	65
Surge Voltage (V <sub>S</sub> )	≤ +125°C:	2.2	3.4	5	8	13	16	20	28	40
Temperature Range:	-55°C to +125°C									
Reliability:	1% per 1000 hours at 85°C, V <sub>R</sub> with 0.1Ω/V series impedance, 60% confidence level									

# TPM Multianode



## Tantalum Ultra Low ESR Capacitor

### CAPACITANCE AND RATED VOLTAGE RANGE LETTER DENOTES CASE SIZE ESR LIMIT IN BRACKETS

Capacitance		Rated Voltage DC (V <sub>R</sub> ) to 85°C								
μF	Code	2.5V (e)	4V (G)	6.3V (J)	10V (A)	16V (C)	20V (D)	25V (E)	35V (V)	50V (T)
10	106									E(120)
15	156									E
22	226								E(60,100)	E
33	336								E(50,65)	
47	476								E(55,65)	
68	686							E(45,55)	V	
100	107						E(35,45)	E		
150	157					E(30,40)	E			
220	227					E(25,40)				
330	337				E(23,35)	E				
470	477			E(18,23,30)	E(23,30)					
680	687		E(18,23)	E(18,23), V(23)	E					
1000	108		E(18,23), V(18)	E						
1500	158	E(12,15,18)	E(15,18)							
2200	228	E(18,25)								

Developmental Ratings - subject to change, AVX reserve rights to change ESR specification prior to release.

Note: Voltage ratings are minimum values. AVX reserves the right to supply higher ratings in the same case size, to the same reliability standards.

# TPM Multianode



## Tantalum Ultra Low ESR Capacitor

### RATINGS & PART NUMBER REFERENCE

AVX Part No.	Case Size	Capacitance (µF)	Rated Voltage (V)	DCL (µA) Max.	DF % Max.	ESR Max. (mΩ) @100kHz	100kHz Ripple Current Ratings (A)			100kHz Ripple Voltage Ratings (V)		
							25°C	85°C	125°C	25°C	85°C	125°C
<b>2.5 Volt @ 85°C (1.7 Volt @ 125°C)</b>												
TPME158*002#0012	E	1500	2.5	38	6	12	4.743	4.269	1.897	0.057	0.051	0.023
TPME158*002#0015	E	1500	2.5	38	6	15	4.243	3.818	1.697	0.064	0.057	0.025
TPME158*002#0018	E	1500	2.5	38	6	18	3.873	3.486	1.549	0.070	0.063	0.028
<b>4 Volt @ 85°C (2.7 Volt @ 125°C)</b>												
TPME687*004#0018	E	680	4	27	6	18	3.873	3.486	1.549	0.070	0.063	0.028
TPME687*004#0023	E	680	4	27	6	23	3.426	3.084	1.370	0.079	0.071	0.032
TPME108*004#0018	E	1000	4	40	6	18	3.873	3.486	1.549	0.070	0.063	0.028
TPME108*004#0023	E	1000	4	40	6	23	3.426	3.084	1.370	0.079	0.071	0.032
TPMV108*004#0018	V	1000	4	40	6	18	3.979	3.581	1.592	0.072	0.064	0.029
TPME158*004#0015	E	1500	4	40	6	15	4.243	3.818	1.697	0.064	0.057	0.025
TPME158*004#0018	E	1500	4	40	6	18	3.873	3.486	1.549	0.070	0.063	0.028
<b>6.3 Volt @ 85°C (4 Volt @ 125°C)</b>												
TPME477*006#0018	E	470	6.3	28	6	18	3.873	3.486	1.549	0.070	0.063	0.028
TPME477*006#0023	E	470	6.3	28	6	23	3.426	3.084	1.370	0.079	0.071	0.032
TPME477*006#0030	E	470	6.3	28	6	30	3.000	2.700	1.200	0.090	0.081	0.036
TPME687*006#0018	E	680	6.3	41	6	18	3.873	3.486	1.549	0.070	0.063	0.028
TPME687*006#0023	E	680	6.3	41	6	23	3.426	3.084	1.370	0.079	0.071	0.032
TPMV687*006#0023	V	680	6.3	41	6	23	3.520	3.168	1.408	0.081	0.073	0.032
<b>10 Volt @ 85°C (7 Volt @ 125°C)</b>												
TPME337*010#0023	E	330	10	33	6	23	3.426	3.084	1.370	0.079	0.071	0.032
TPME337*010#0035	E	330	10	33	6	35	2.777	2.500	1.111	0.097	0.087	0.039
TPME477M010#0023	E	470	10	47	6	23	3.426	3.084	1.370	0.079	0.071	0.032
TPME477M010#0030	E	470	10	47	6	30	3.000	2.700	1.200	0.090	0.081	0.036
<b>16 Volt @ 85°C (10 Volt @ 125°C)</b>												
TPME157*016#0030	E	150	16	24	6	30	3.000	2.700	1.200	0.090	0.081	0.036
TPME157*016#0040	E	150	16	24	6	40	2.598	2.338	1.039	0.104	0.094	0.042
TPME227*016#0025	E	220	16	35	6	25	3.286	2.958	1.315	0.082	0.074	0.033
TPME227*016#0040	E	220	16	35	6	40	2.598	2.338	1.039	0.104	0.094	0.042
<b>20 Volt @ 85°C (13 Volt @ 125°C)</b>												
TPME107*020#0035	E	100	20	20	6	35	2.777	2.500	1.111	0.097	0.087	0.039
TPME107*020#0045	E	100	20	20	6	45	2.449	2.205	0.980	0.110	0.099	0.044
<b>25 Volt @ 85°C (17 Volt @ 125°C)</b>												
TPME686*025#0045	E	68	25	17	6	45	2.449	2.205	0.980	0.110	0.099	0.044
TPME686*025#0055	E	68	25	17	6	55	2.216	1.994	0.886	0.122	0.110	0.049
<b>35 Volt @ 85°C (23 Volt @ 125°C)</b>												
TPME226*335#0060	E	22	35	8	6	60	2.121	1.909	0.849	0.127	0.115	0.051
TPME226*035#0100	E	22	35	8	6	100	1.643	1.479	0.657	0.164	0.148	0.066
TPME336*035#0050	E	33	35	12	6	50	2.324	2.091	0.930	0.116	0.105	0.046
TPME336*035#0065	E	33	35	12	6	65	2.038	1.834	0.815	0.132	0.119	0.053
TPME476*035#0055	E	47	35	16	6	55	2.216	1.994	0.886	0.122	0.110	0.049
TPME476*035#0065	E	47	35	16	6	65	2.038	1.834	0.815	0.132	0.119	0.053
<b>50 Volt @ 85°C (33 Volt @ 125°C)</b>												
TPME106*050#0120	E	10	50	5	6	120	1.500	1.350	0.600	0.180	0.162	0.072

All technical data relates to an ambient temperature of +25°C.  
 Capacitance and DF are measured at 120Hz,  
 0.5V RMS with maximum DC bias of 2.2 volts.  
 DCL is measured at rated voltage after 5 minutes.

\* Insert K for ±10% and M for ±20% Capacitance Tolerance

### TPM MULTIANODE CONSTRUCTION

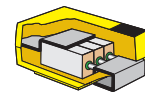

# TPC Series



## Low ESR TACmicrochip™

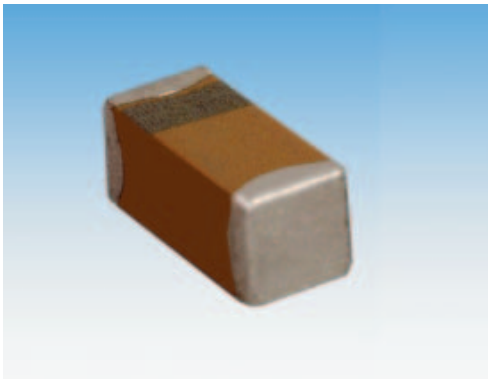

The world's smallest surface mount Tantalum capacitor, small enough to create space providing room for ideas to grow.

TACmicrochip™ is a major breakthrough in miniaturization without reduction in performance.

It offers you the highest energy store in an 0603 or 0805 case size; enhanced high frequency operation through unique ESR performance with temperature and voltage stability.



LEAD-FREE



HALOGEN-FREE COMPOUNDS

ENVIRONMENTAL FRIENDLY COMPONENT

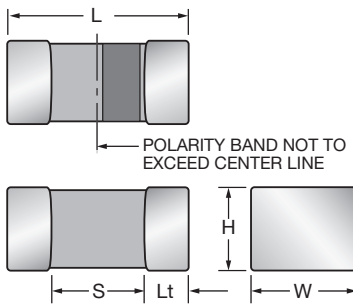

### CASE DIMENSIONS: millimeters (inches)

Code	EIA Code	EIA Metric	Length (L)	Width (W)	Height (H)	Termination Spacing(S)	Minimum Termination Length (Lt)	Average Mass
L	0603	1608-10	1.60 +0.20 -0.00 (0.063 +0.008 -0.000)	0.85 +0.15 -0.00 (0.033 +0.006 -0.000)	0.85 +0.15 -0.00 (0.033 +0.006 -0.000)	0.65 min	0.15 (0.006)	8.6mg
R	0805	2012-15	2.00 +0.20 -0.00 (0.079 +0.008 -0.000)	1.35 +0.15 -0.00 (0.053 +0.006 -0.000)	1.35 +0.15 -0.00 (0.053 +0.006 -0.000)	0.85 min	0.15 (0.006)	29.9mg

### HOW TO ORDER

<b>TPC</b>	<b>R</b>	<b>106</b>	<b>M</b>	<b>010</b>	<b>R</b>	<b>1800</b>
Type TACmicrochip™	Case Size 0603=L 0805=R	Capacitance Code pF code: 1st two digits represent significant figures, 3rd digit represents multiplier (number of zeros to follow)	Tolerance K=±10% M=±20%	Rated DC Voltage 002=2Vdc 003=3Vdc 004=4Vdc 006=6.3Vdc 010=10Vdc 016=16Vdc 020=20Vdc 025=25Vdc	Packaging (see table below)	Maximum ESR in Milliohms See note below

**NOTE:** The EIA & CECC standards for low ESR Solid Tantalum Capacitors allow an ESR movement to 1.25 times catalog limit post mounting.

### Packaging Suffix

Reel Size	Standard Tin Termination Plastic Tape	Gold Termination Plastic Tape
Case	R/L	R/L
7"	Rxxxx	Axxxx
4 1/2"	Xxxxx	Fxxxx

**NOTE:** xxxx = ESR Value in Milliohms

### TECHNICAL SPECIFICATIONS

Technical Data:	All technical data relate to an ambient temperature of +25°C							
Capacitance Range:	3.3µF to 47µF							
Capacitance Tolerance:	±10%; ±20%							
Leakage Current DCL:	0.01CV or 0.5µA whichever is the greater							
Rated Voltage (V <sub>R</sub> )	≧ +85°C:	3	4	6.3	10	16	20	25
Category Voltage (V <sub>C</sub> )	≧ +125°C:	2	2.7	4	7	10	13	17
Surge Voltage (V <sub>S</sub> )	≧ +85°C:	3.9	5.2	8	13	20	26	32
Surge Voltage (V <sub>S</sub> )	≧ +125°C:	2.6	3.2	5	8	12	16	20
Temperature Range:	-55°C to +125°C							
Reliability:	1% per 1000 hours at 85°C, V with 0.1Ω/V series impedance, 60% confidence level							
Termination Finish:	Nickel and Tin Plating (standard), Nickel and Gold Plating option available upon request							



# TPC Series



## Low ESR TACmicrochip™

### LOW ESR RANGE

(LETTER DENOTES CASE SIZE) (ESR in mΩ)

Capacitance		Voltage Rating DC (V <sub>R</sub> ) at 85°C							
Cap. (μF)	Code	2.0V	3.0V	4.0V	6.3V	10V	16V	20V	25V
0.33 0.47 0.68	334 474 684								
1.0 1.5 2.2	105 155 225								R(3000)
3.3 4.7 6.8	335 475 685					L(5000) L(5000)			
10 15 22	106 156 226			R(1800)	L(4000) R(1800) R(1500)	L(4000),R(1800) R(1500)	R(1800)		
33 47 68	336 476 686		R(1800) R(1500)	R(1500)					
100 150 220	107 157 227								

### RATINGS & PART NUMBER REFERENCE

AVX Part No.	EIA	Case Size	Capacitance (μF)	Rated Voltage (V)	DCL (μA) Max.	DF % Max.	ESR Max. (mΩ) @100kHz	100kHz Ripple Current Ratings (A)			100kHz Ripple Voltage Ratings (V)		
								25°C	85°C	125°C	25°C	85°C	125°C
TPCR336*003#	0805	R	33	3.0	1.0	10	1800	0.158	0.142	0.063	0.285	0.256	0.114
TPCR476*003#	0805	R	47	3.0	1.5	10	1500	0.173	0.156	0.069	0.260	0.234	0.104
TPCR226*004#	0805	R	22	4.0	0.9	8	1800	0.158	0.142	0.063	0.285	0.256	0.114
TPCR336*004#	0805	R	33	4.0	1.3	10	1500	0.173	0.156	0.069	0.260	0.234	0.104
TPCL106M006#	0603	L	10	6.3	0.6	10	4000	0.079	0.071	0.032	0.316	0.285	0.126
TPCR156*006#	0805	R	15	6.3	0.9	8	1800	0.158	0.142	0.063	0.285	0.256	0.114
TPCR226*006#	0805	R	22	6.3	1.4	10	1500	0.173	0.156	0.069	0.260	0.234	0.104
TPCL335*010#	0603	L	3.3	10.0	0.5	8	5000	0.071	0.064	0.028	0.354	0.318	0.141
TPCL475M010#	0603	L	4.7	10.0	0.5	10	5000	0.071	0.064	0.028	0.354	0.318	0.141
TPCL106M010#	0603	L	10	10.0	1.0	20	4000	0.079	0.071	0.032	0.316	0.285	0.126
TPCR106*010#	0805	R	10	10.0	1.0	8	1800	0.158	0.142	0.063	0.285	0.256	0.114
TPCR156*010#	0805	R	15	10.0	1.5	10	1500	0.173	0.156	0.069	0.260	0.234	0.104
TPCR106*016#	0805	R	10	16.0	1.6	10	1800	0.158	0.142	0.063	0.285	0.256	0.114
TPCR105*025#	0805	R	1.0	25.0	0.5	8	3000	0.122	0.110	0.049	0.367	0.331	0.147

All technical data relates to an ambient temperature of +25°C. Capacitance and DF are measured at 120Hz, 0.5V RMS with a maximum DC bias of 2.2 volts. DCL is measured at rated voltage after 5 minutes.

\* Insert K for ±10% and M for ±20% Capacitance Tolerance

**NOTE: AVX reserves the right to supply a higher voltage rating or tighter tolerance part in the same case size, to the same reliability standards.**

The EIA & CECC standards for Low ESR Solid Tantalum Capacitors allow an ESR movement to 1.25 times catalog limit post mounting.





# TCJ Series



## Tantalum Solid Electrolytic Chip Capacitors with Conductive Polymer Electrode



The TCJ Series of tantalum capacitors with a conductive polymer electrode offers lower ESR, safer non-ignition failure mode and better capacitance retention compared to the conventional MnO<sub>2</sub> electrode capacitors. The TCJ series is suitable for power management systems with operating temperatures up to 125°C. In addition the TCJ series complies with RoHS requirements and it is an environmentally friendly component ready for lead-free assembly systems up to 3x reflow with 260°C peak temperature. Small A and B case sizes are ideal for use with the latest portable handheld electronics such as cellular phones, PDAs or other digital equipment such as cameras.



LEAD-FREE

LEAD-FREE COMPATIBLE COMPONENT



HALOGEN-FREE COMPOUNDS

ENVIRONMENTAL FRIENDLY COMPONENT

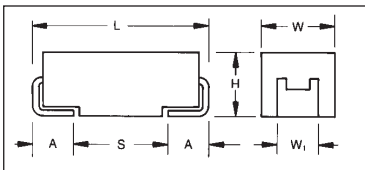

### CASE DIMENSIONS: millimeters (inches)

Code	EIA Code	L±0.20 (0.008)	W+0.20 (0.008) -0.10 (0.004)	H+0.20 (0.008) -0.10 (0.004)	W <sub>1</sub> ±0.20 (0.008)	A+0.30 (0.012) -0.20 (0.008)	S Min.
A	3216-18	3.20 (0.126)	1.60 (0.063)	1.60 (0.063)	1.20 (0.047)	0.80 (0.031)	1.10 (0.043)
B	3528-21	3.50 (0.138)	2.80 (0.110)	1.90 (0.075)	2.20 (0.087)	0.80 (0.031)	1.40 (0.055)
T	3528-12	3.50 (0.138)	2.80 (0.110)	1.20 (0.047) max	2.20 (0.087)	0.80 (0.031)	1.40 (0.055)
W	6032-15	6.00 (0.236)	3.20 (0.126)	1.50 (0.059) max	2.20 (0.087)	1.30 (0.051)	2.90 (0.114)
Y	7343-20	7.30 (0.287)	4.30 (0.169)	2.00 (0.079) max	2.40 (0.094)	1.30 (0.051)	4.40 (0.173)

W<sub>1</sub> dimension applies to the termination width for A dimensional area only.

### Marking

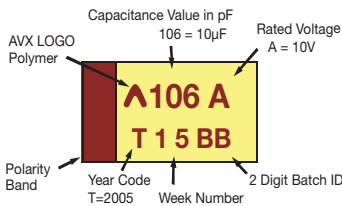

### Packaging Suffix

Reel Quantity	R = 7" Reel	S = 13" Reel	Tape Width
A Case	2000	8000	8 mm
B Case	2000	8000	8 mm
T Case	2500	10000	8 mm
W Case	1000	5000	12 mm
Y Case	1000	4000	12 mm

### HOW TO ORDER

**TCJ**

Type

**A**

Case Size  
See table above

**226**

Capacitance Code  
pF code: 1st two digits represent significant figures, 3rd digit represents multiplier (number of zeros to follow)

**M**

Tolerance  
M=±20%

**004**

Rated DC Voltage  
002=2.5Vdc  
004=4Vdc  
006=6.3Vdc  
010=10Vdc

**R**

Packaging  
R=7" T/R  
S=13" T/R

**0300**

ESR in mΩ

### TECHNICAL SPECIFICATIONS

Technical Data:

All technical data relate to an ambient temperature of +25°C

Capacitance Range: 10µF to 100µF

Capacitance Tolerance: ±20%

Leakage Current DCL: 0.1CV

Rated Voltage (V <sub>R</sub> )	≤ +85°C:	2.5	4	6.3	10
Category Voltage (V <sub>C</sub> )	≤ +125°C:	1.7	2.7	4	7
Surge Voltage (V <sub>S</sub> )	≤ +85°C:	3.3	5.2	8	13
Surge Voltage (V <sub>S</sub> )	≤ +125°C:	2.0	3.4	5.0	8

Temperature Range: -55°C to +125°C

Reliability: 1% per 1000 hours at 85°C, V<sub>R</sub> with 0.1Ω/V<sub>R</sub> series impedance, 60% confidence level



# TCJ Series



## Tantalum Solid Electrolytic Chip Capacitors with Conductive Polymer Electrode

### CAPACITANCE AND RATED VOLTAGE, $V_R$ (VOLTAGE CODE) RANGE (LETTER DENOTES CASE SIZE)

Capacitance		Rated Voltage DC ( $V_R$ ) to 85°C		
Cap. ( $\mu$ F)	Code	4V (G)	6.3V (J)	10V (A)
10	106		A (300)	A (300)
15	156	A (300)	A (300)	
22	226	A (300)		B (300)
33	336			B (200)
47	476		T (80), B (70)	B (70)
68	686	B (70)	B (70)	
100	107	B (70)	B (70)	
150	157	W (70)	W (70), Y (25)	
220	227	Y (25)	Y (25)	

Developmental Ratings - subject to change.

Available Ratings, (ESR ratings in mOhms in brackets)

The EIA and CECC standards for low ESR solid Tantalum capacitors allow an ESR movement to 1.25 times catalog limit post mounting.

### RATINGS & PART NUMBER REFERENCE

AVX Part No.	Case Size	Capacitance ( $\mu$ F)	Rated Voltage (V)	DCL ( $\mu$ A) Max.	DF % Max.	ESR Max. (m $\Omega$ ) @100kHz	100kHz RMS Current (mA)			100kHz RMS Voltage (mV)			
							25°C	85°C	125°C	25°C	85°C	125°C	
<b>4 Volt @ 85°C (2.7 Volt @ 125°C)</b>													
TCJA156M004#0300	A	15	4	6.0	6	300	500	450	200	150	135	60	
TCJA226M004#0300	A	22	4	8.8	6	300	500	450	200	150	135	60	
TCJB686M004#0070	B	68	4	27.2	6	70	1102	992	441	77	69	31	
TCJB107M004#0070	B	100	4	40.0	8	70	1102	992	441	77	69	31	
<b>6.3 Volt @ 85°C (4 Volt @ 125°C)</b>													
TCJA106M006#0300	A	10	6.3	6.0	6	300	500	450	200	150	135	60	
TCJA156M006#0300	A	15	6.3	9.0	6	300	500	450	200	150	135	60	
TCJB476M006#0070	B	47	6.3	28.2	6	70	1102	992	441	77	69	31	
TCJT476M006#0080	T	47	6.3	28.2	8	80	1000	900	400	80	72	32	
TCJB686M006#0070	B	68	6.3	40.8	8	70	1102	992	441	77	69	31	
TCJB107M006#0070	B	100	6.3	60.0	10	70	1102	992	441	77	69	31	
<b>10 Volt @ 85°C (7 Volt @ 125°C)</b>													
TCJA106M010#0300	A	10	10	10.0	6	300	500	450	200	150	135	60	
TCJB226M010#0300	B	22	10	22.0	6	300	532	479	213	160	144	64	
TCJB336M010#0200	B	33	10	33.0	6	200	652	587	261	130	117	52	
TCJB476M010#0070	B	47	10	47.0	6	70	1102	992	441	77	69	31	

# insert R for 7" reel or S for 13" reel

All technical data relates to an ambient temperature of +25°C. Capacitance and DF are measured at 120Hz, 0.5 RMS with DC bias of 2.2 volts. DCL is measured at rated voltage after 5 minutes.

**NOTE: AVX reserves the right to supply a higher voltage rating in the same case size, to the same reliability standards.**

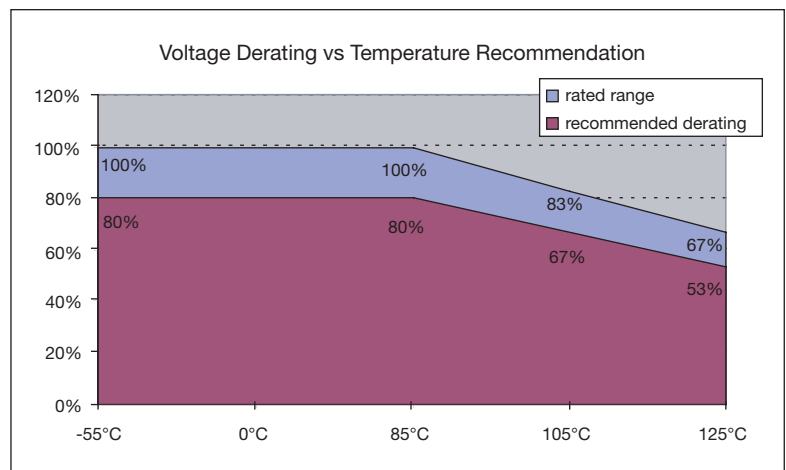

# TLJ Series

## Tantalum Solid Electrolytic Chip Capacitors Consumer Series

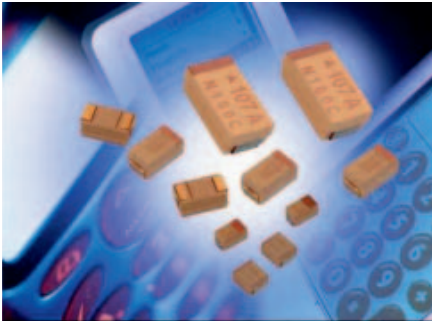

The consumer TLJ series of tantalum capacitors offers high capacitance vs. voltage ratio based on stable MnO<sub>2</sub> electrode capacitors. The TLJ series complies with RoHS requirements and it is an environmentally friendly component ready for lead-free assembly systems up to 3x reflow with 260°C peak temperature. The TLJ series is suitable for wide range of consumer electronic applications such as the latest portable handheld electronics, cellular phones, PDAs or other digital equipment and cameras.

- High Volumetric Efficiency
- Environmentally Friendly
- Small & Low Profile Cases
- 3x Reflow 260°C Compatible
- Consumer Applications

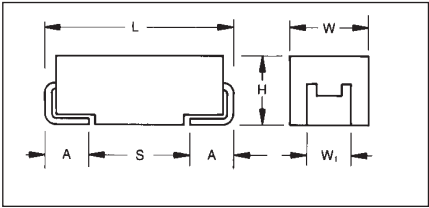

**LEAD-FREE**  
LEAD-FREE COMPATIBLE COMPONENT



**HALOGEN-FREE COMPOUNDS**  
ENVIRONMENTAL FRIENDLY COMPONENT

### Marking

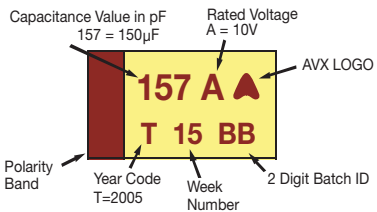

### CASE DIMENSIONS: millimeters (inches)

Code	EIA Code	L±0.20 (0.008)	W+0.20 (0.008) -0.10 (0.004)	H+0.20 (0.008) -0.10 (0.004)	W <sub>1</sub> ±0.20 (0.008)	A+0.30 (0.012) -0.20 (0.008)	S Min.
A	3216-18	3.20 (0.126)	1.60 (0.063)	1.60 (0.063)	1.20 (0.047)	0.80 (0.031)	1.10 (0.043)
B	3528-21	3.50 (0.138)	2.80 (0.110)	1.90 (0.075)	2.20 (0.087)	0.80 (0.031)	1.40 (0.055)
R	2012-12	2.05 (0.081)	1.30 (0.051)	1.20 (0.047) max	1.0±0.1 (0.039±0.004)	0.50 (0.020)	0.85 (0.033)
T	3528-12	3.50 (0.138)	2.80 (0.110)	1.20 (0.047) max	2.20 (0.087)	0.80 (0.031)	1.40 (0.055)
W	6032-15	6.00 (0.236)	3.20 (0.126)	1.50 (0.059) max	2.20 (0.087)	1.30 (0.051)	2.90 (0.114)

W<sub>1</sub> dimension applies to the termination width for A dimensional area only.

### Packaging Suffix

Reel Quantity	R = 7" Reel	S = 13" Reel	Tape Width
A Case	2000	10000	8 mm
B Case	2000	10000	8 mm
R Case	2500	10000	8 mm
T Case	2500	10000	8 mm
W Case	1000	5000	12 mm

### HOW TO ORDER

**TLJ**

Type

**W**

Case Size  
See table above

**157**

Capacitance Code  
pF code: 1st two digits represent significant figures, 3rd digit represents multiplier (number of zeros to follow)

**M**

Tolerance  
M=±20%

**010**

Rated DC Voltage  
002=2.5Vdc  
004=4Vdc  
006=6.3Vdc  
010=10Vdc  
016=16Vdc

**R**

Packaging  
R=7" T/R  
S=13" T/R

**0200**

ESR in mΩ

### TECHNICAL SPECIFICATIONS

Technical Data:	All technical data relate to an ambient temperature of +25°C					
Capacitance Range:	10µF to 150µF					
Capacitance Tolerance:	±20%					
Rated Voltage (V <sub>R</sub> )	-55°C ≤ +40°C:	4	6.3	10	16	
Category Voltage (V <sub>C</sub> )	at 85°C:	2	3.15	5	8	
Category Voltage (V <sub>C</sub> )	at 125°C:	0.8	1.26	2	3.2	
Temperature Range:	-55°C to +125°C with category voltage					
Reliability:	0.2% per 1000 hours at 85°C, 0.5xV <sub>R</sub> , with 0.1Ω/V series impedance with 60% confidence level					

# TLJ Series



## Tantalum Solid Electrolytic Chip Capacitors Consumer Series

### CAPACITANCE AND RATED VOLTAGE, $V_R$ (VOLTAGE CODE) RANGE (LETTER DENOTES CASE SIZE)

Capacitance		Rated Voltage DC to 40°C / 0.5DC to 85°C / 0.2DC to 125°C				
Cap. (µF)	Code	2.5V (e)	4V (G)	6.3V (J)	10V (A)	16V (C)
3.3	335					
4.7	475					Q
6.8	685					R
10	106				Q*/R(3000)	P
15	156			Q*	Q*/R	P/S
22	226			Q*/R(3500)	P	A/T(600)
33	336		Q/R	P/R(3000)	S	T
47	476	Q/R	P/R(3000)	S	A/T(600)	B
68	686	P	S	A/T*	A/T	B/W
100	107	S	A(500)	A(500,800)/T*	T	W
150	157	A	A/T*	T	B(500)/W(200)	
220	227	A/T	T	B*/W*		
330	337	T	B*/W*	B		
470	477	B*/W*	B*			
680	687					
1000	108					

Red - Developmental Ratings - subject to change

Violet - Please Contact Manufacturer

Available Ratings, (ESR ratings in mOhms in brackets)

### RATINGS & PART NUMBER REFERENCE

AVX Part No.	Case Size	Capacitance (µF)	Rated Voltage (V)	Maximum Surge Current (A)*	DCL (µA) Max.	ESR Max. (mΩ) @100kHz	100kHz Ripple Current (mA)		100kHz Ripple Voltage (mV)			
							25°C	85°C	25°C	85°C	125°C	
<b>4 Volt @ 40°C (2 Volt @ 85°C, 0.8 Volt @ 125°C)</b>												
TLJR476M004#3000	R	47	4	0.6	1.9	3000	135	122	54	406	366	162
TLJA107M004#0500	A	100	4	2.1	4.0	500	387	349	155	194	174	77
<b>6.3 Volt @ 40°C (3.15 Volt @ 85°C, 1.26 Volt @ 125°C)</b>												
TLJR226M006#3500	R	22	6.3	0.8	1.3	3500	125	113	50	439	395	175
TLJR336M006#3000	R	33	6.3	0.9	2.0	3000	135	122	54	406	366	162
TLJA107M006#0500	A	100	6.3	3.3	6.0	500	387	349	155	194	174	77
TLJA107M006#0800	A	100	6.3	2.5	6.0	800	306	276	122	245	220	98
<b>10 Volt @ 40°C (5 Volt @ 85°C, 2 Volt @ 125°C)</b>												
TLJR106M010#3000	R	10	10	1.4	1.0	3000	135	122	54	406	366	162
TLJT476M010#0600	T	47	10	4.8	4.7	600	365	329	146	219	197	88
TLJB157M010#0500	B	150	10	5.3	15.0	500	412	371	165	206	186	82
TLJW157M010#0200	W	150	10	7.7	15.0	200	671	604	268	134	121	54
<b>16 Volt @ 40°C (8 Volt @ 85°C, 3.2 Volt @ 125°C)</b>												
TLJT226M016#0600	T	22	16	7.6	3.5	600	365	329	146	219	197	88

# insert R for 7" reel or S for 13" reel

All technical data relates to an ambient temperature of +25°C. Capacitance and DF are measured at 120Hz, 0.5 RMS with DC bias of 2.2 volts. DCL is measured at rated voltage after 5 minutes. TLJ series is MSL level 3 device.

ESR allowed to move up to 1.25 times catalog limit post mounting.

DCL allowed to move up to 2.00 times catalog limit post mounting.

**NOTE: AVX reserves the right to supply a higher voltage rating in the same case size, to the same reliability standards.**

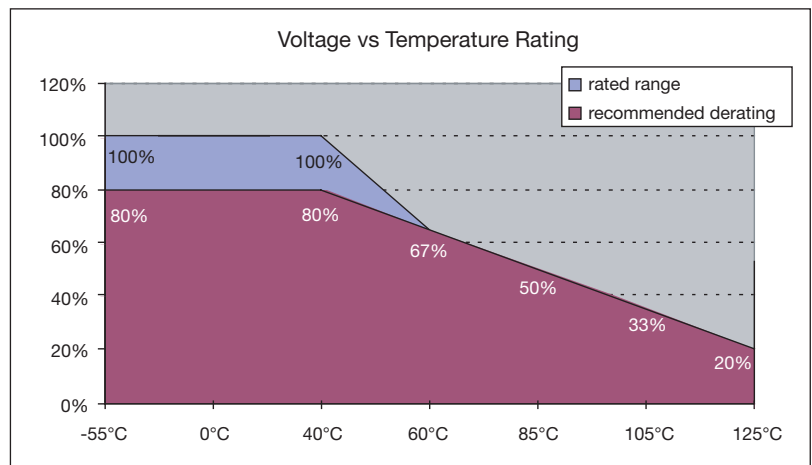

# TRJ Series



## Professional Tantalum Chip Capacitor (also available as COTS-Plus option)



The TRJ surface mount series employs established Tantalum technology together with new process improvements and advanced manufacturing techniques. This robust series enables extension of the guaranteed 0.5% reliability level to 1000 hours at rated voltage, rated temperature and 0.1Ω/volt circuit impedance. The moisture penetration barrier, thicker external dielectric layer and modified manganising process make the capacitor more robust against higher thermo-mechanical stresses during assembly process (“lead-free”

soldering) and also more robust against more severe working conditions in Automotive, Medical, Aerospace, Military and other applications. The temperature range is -55°C to 125°C and voltage range is 6.3V to 35V.

These components do not contain any lead either in the internal structure or in the termination plating. They are compatible with all SnPb and “lead-free” solders and are qualified for higher reflow temperature necessary for new lead-free assembly process.

### CASE DIMENSIONS: millimeters (inches)

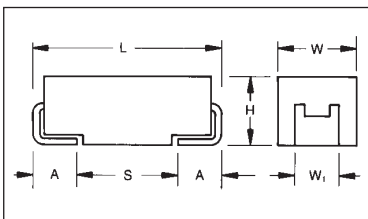

For part marking see page 121

Code	EIA Code	L±0.20 (0.008)	W+0.20 (0.008) -0.10 (0.004)	H+0.20 (0.008) -0.10 (0.004)	W <sub>1</sub> ±0.20 (0.008)	A+0.30 (0.012) -0.20 (0.008)	S Min.
A	3216-18	3.20 (0.126)	1.60 (0.063)	1.60 (0.063)	1.20 (0.047)	0.80 (0.031)	1.10 (0.043)
B	3528-21	3.50 (0.138)	2.80 (0.110)	1.90 (0.075)	2.20 (0.087)	0.80 (0.031)	1.40 (0.055)
C	6032-28	6.00 (0.236)	3.20 (0.126)	2.60 (0.102)	2.20 (0.087)	1.30 (0.051)	2.90 (0.114)
D	7343-31	7.30 (0.287)	4.30 (0.169)	2.90 (0.114)	2.40 (0.094)	1.30 (0.051)	4.40 (0.173)
E	7343-43	7.30 (0.287)	4.30 (0.169)	4.10 (0.162)	2.40 (0.094)	1.30 (0.051)	4.40 (0.173)

W<sub>1</sub> dimension applies to the termination width for A dimensional area only.

### HOW TO ORDER

**TRJ**

Type

**B**

Case Size  
See table above

**105**

Capacitor Code  
pF code: 1st two digits represent significant figures, 3rd digit represents multiplier (number of zeros to follow)

**\***

Tolerance  
K=±10%  
M=±20%

**035**

Rated DC Voltage  
006 = 6.3V  
010 = 10V  
016 = 16V  
020 = 20V  
025 = 25V  
035 = 35V  
050 = 50V

**R**

Packaging/  
Termination Plating  
R = 7" T/R  
Lead Free  
S = 13" T/R  
Lead Free  
A = Gold Plating  
7" Reel  
B = Gold Plating  
13" Reel

**RJ**

Additional characters may be added for special requirements

### TECHNICAL SPECIFICATIONS

Technical Data:	All technical data relate to an ambient temperature of +25°C							
Capacitance Range:	0.1µF to 470µF							
Capacitance Tolerance:	±10%; ±20%							
Leakage Current DCL:	0.0075CV							
Rated Voltage (V <sub>R</sub> )	≤ +85°C:	6.3	10	16	20	25	35	50
Category Voltage (V <sub>C</sub> )	≤ +125°C:	4	7	10	13	17	23	33
Surge Voltage (V <sub>S</sub> )	≤ +85°C:	8	13	20	26	32	46	65
Surge Voltage (V <sub>S</sub> )	≤ +125°C:	5	8	13	16	20	28	40
Temperature Range:	-55°C to +125°C							
Reliability:	0.5% per 1000 hours at 85°C, V <sub>R</sub> with 0.1Ω/V series impedance, 60% confidence level							
Termination Plating:	Sn Plating (standard), Gold and SnPb Plating upon request Meets requirements of AEC-Q200							

### CAPACITANCE AND RATED VOLTAGE, $V_R$ (VOLTAGE CODE) RANGE LETTER DENOTES CASE SIZE

Capacitance		Rated Voltage DC ( $V_R$ ) to 85°C						
$\mu\text{F}$	Code	6.3V (J)	10V (A)	16V (C)	20V (D)	25V (E)	35V (V)	50V (T)
0.10	104						A	
0.15	154						A	
0.22	224						A	
0.33	334						A	
0.47	474					A	A	
0.68	684					A	A	
1.0	105				A	A	A/B	
1.5	155				A	A	A/B	
2.2	225			A	A	A/B	B	
3.3	335			A	A/B	B	B/C	D
4.7	475		A	A/B	A/B	B	B/C	D
6.8	685		A	A/B	B	B/C	C	D
10	106	A	A/B	B	B/C	C	C/D	E
15	156	A/B	A/B	B	B/C	C/D	C/D	
22	226	A/B	B	C	C/D	C/D	D	
33	336	B	B/C	C	C/D	D	D/E	
47	476	B/C	C	C/D	D	D/E		
68	686	C	C	D	D/E			
100	107	C	D	D/E	D/E			
150	157	C/D	D/E	E				
220	227	D	D/E					
330	337	E	E					
470	477	E						

Note: Voltage ratings are minimum values. AVX reserves the right to supply higher ratings in the same reliability standards.

Developmental Ratings - subject to change

### HOW TO ORDER – FOR COTS-Plus PRODUCTS

**TRJ**

Type

**B**

Case Size

**105**

Capacitance Code  
pF code: 1st two digits represent significant figures  
3rd digit represents multiplier (number of zeros to follow)

**M**

Tolerance  
K=±10%  
M=±20%

**035**

Rated DC Voltage  
006=6.3Vdc  
010=10Vdc  
016=16Vdc  
020=20Vdc  
025=25Vdc  
035=35Vdc

**E**

Packaging/  
Termination Plating  
E = non modular quantity tin/lead termination finish

**C000**

Additional characters may be added for special requirements (see below)

#### Suffix details

##### First digit

C = for COTS-Plus

##### Second digit

0 (zero) = for no surge requirement  
S = for 10 cycles, 25°C surge  
T = for 10 cycles, -55 and 85°C surge

##### Third digit

0 (zero) = standard ESR  
L = for low ESR

##### Fourth digit

0 (zero) = standard M/L level reliability  
B = for Weibull grade "B"  
C = for Weibull grade "C"  
Z = for non ER

### RATINGS & PART NUMBER REFERENCE

AVX Part No.	Case Size	Capacitance (µF)	DCL (µA) Max.	DF % Max.	ESR Max. (Ω) @ 100 kHz
<b>Voltage Rating 6.3 v @ 85°C (4 v @ 125°C)</b>					
TRJA106*006#	A	10	0.45	6	2.2
TRJA156*006#	A	15	0.68	6	2.0
TRJB156*006#	B	15	0.68	6	2.0
TRJB226*006#	B	22	0.99	6	1.9
TRJB336*006#	B	33	1.5	6	1.7
TRJB476*006#	B	47	2.1	6	1.6
TRJC476*006#	C	47	2.1	6	0.5
TRJC686*006#	C	68	3.1	6	0.5
TRJC107*006#	C	100	4.5	6	0.4
TRJD157*006#	D	150	6.8	6	0.4
TRJD227*006#	D	220	9.9	8	0.4
TRJE337*006#	E	330	14	8	0.3
<b>Voltage Rating 10 v @ 85°C (7 v @ 125°C)</b>					
TRJA475*010#	A	4.7	0.35	6	3.2
TRJA685*010#	A	6.8	0.51	6	2.6
TRJA106*010#	A	10	0.75	6	2.2
TRJB106*010#	B	10	0.75	6	2.2
TRJB156*010#	B	15	1.1	6	2.0
TRJB226*010#	B	22	1.7	6	1.9
TRJC336*010#	C	33	2.5	6	0.6
TRJC476*010#	C	47	3.5	6	0.5
TRJC686*010#	C	68	5.1	6	0.5
TRJD107*010#	D	100	7.5	6	0.4
TRJD157*010#	D	150	11	8	0.4
TRJE157*010#	E	150	11	8	0.4
TRJE227*010#	E	220	17	8	0.4
<b>Voltage Rating 16 v @ 85°C (10 v @ 125°C)</b>					
TRJA225*016#	A	2.2	0.30	6	4.5
TRJA335*016#	A	3.3	0.40	6	3.7
TRJA475*016#	A	4.7	0.56	6	3.2
TRJB475*016#	B	4.7	0.56	6	3.2
TRJB685*016#	B	6.8	0.82	6	2.6
TRJB106*016#	B	10	1.2	6	2.2
TRJB156*016#	B	15	1.8	6	2.0
TRJC226*016#	C	22	2.6	6	0.7
TRJC336*016#	C	33	4.0	6	0.6
TRJC476*016#	C	47	5.6	6	0.5
TRJD476*016#	D	47	5.6	6	0.5
TRJD686*016#	D	68	8.2	6	0.5
TRJD107*016#	D	100	12	6	0.4
TRJE107*016#	E	100	12	6	0.4

All technical data relates to an ambient temperature of +25°C. Capacitance and DF are measured at 120Hz, 0.5V RMS with a maximum DC bias of 2.2 volts. DCL is measured at rated voltage after 5 minutes.

\* Insert K for ±10% and M for ±20%

# Termination finished and packaging reel size

**NOTE: AVX reserves the right to supply higher specification parts in the same case size, to the same reliability standards.**

### COTS-Plus Low ESR options available for:

Case	Capacitance	Volts	ESR Max. (mΩ) @ 100 kHz
B	33	6	600
C	100	6	150
D	220	6	100
E	330	6	100
E	470	6	50
B	22	10	700
D	100	10	100
D	150	10	150
B	15	16	800
C	22	16	375
C	47	16	350
D	47	16	150
D	100	16	125
D	33	20	200
E	68	20	150
C	10	25	500
D	22	25	200
C	4.7	35	600
D	10	35	300
D	22	35	400

AVX Part No.	Case Size	Capacitance (µF)	DCL (µA) Max.	DF % Max.	ESR Max. (Ω) @ 100 kHz
<b>Voltage Rating 20 v @ 85°C (13 v @ 125°C)</b>					
TRJA105*020#	A	1	0.30	4	6.6
TRJA155*020#	A	1.5	0.30	6	5.5
TRJA225*020#	A	2.2	0.33	6	4.5
TRJA335*020#	A	3.3	0.50	6	3.7
TRJB335*020#	B	3.3	0.50	6	3.7
TRJB475*020#	B	4.7	0.71	6	3.2
TRJB685*020#	B	6.8	1.0	6	2.6
TRJB106*020#	B	10	1.5	6	2.2
TRJC106*020#	C	10	1.5	6	0.8
TRJC156*020#	C	15	2.3	6	0.7
TRJC226*020#	C	22	3.3	6	0.7
TRJD226*020#	D	22	3.3	6	0.7
TRJC336*020#	C	33	5.0	6	0.6
TRJD336*020#	D	33	5.0	6	0.6
TRJD476*020#	D	47	7.1	6	0.5
TRJD686*020#	D	68	10	6	0.5
TRJE686*020#	E	68	10	6	0.5
<b>Voltage Rating 25 v @ 85°C (17 v @ 125°C)</b>					
TRJA474*025#	A	0.47	0.30	4	9.5
TRJA684*025#	A	0.68	0.30	4	8.0
TRJA105*025#	A	1	0.30	4	6.6
TRJA155*025#	A	1.5	0.30	6	5.5
TRJB225*025#	B	2.2	0.41	6	4.5
TRJB335*025#	B	3.3	0.62	6	3.7
TRJB475*025#	B	4.7	0.88	6	3.2
TRJC685*025#	C	6.8	1.3	6	1.1
TRJC106*025#	C	10	1.9	6	0.8
TRJC156*025#	C	15	2.8	6	0.7
TRJD156*025#	D	15	2.8	6	0.7
TRJD226*025#	D	22	4.1	6	0.7
TRJD336*025#	D	33	6.2	6	0.6
TRJE476*025#	E	47	8.8	6	0.5
<b>Voltage Rating 35 v @ 85°C (23 v @ 125°C)</b>					
TRJA104*035#	A	0.1	0.30	4	20
TRJA154*035#	A	0.15	0.30	4	16
TRJA224*035#	A	0.22	0.30	4	14
TRJA334*035#	A	0.33	0.30	4	11
TRJA474*035#	A	0.47	0.30	4	9.5
TRJA684*035#	A	0.68	0.30	4	8.0
TRJA105*035#	A	1	0.30	4	6.6
TRJB105*035#	B	1	0.30	4	3.4
TRJB155*035#	B	1.5	0.39	6	5.5
TRJB225*035#	B	2.2	0.58	6	4.5
TRJB335*035#	B	3.3	0.87	6	3.7
TRJC335*035#	C	3.3	0.87	6	1.8
TRJC475*035#	C	4.7	1.2	6	1.4
TRJC685*035#	C	6.8	1.8	6	1.1
TRJC106*035#	C	10	2.6	6	0.8
TRJD106*035#	D	10	2.6	6	0.8
TRJD156*035#	D	15	3.9	6	0.7
TRJD226*035#	D	22	5.8	6	0.7
TRJE336*035#	E	33	8.7	6	0.6
<b>Voltage Rating 50 v @ 85°C (33 v @ 125°C)</b>					
TRJD335*050#	D	3.3	1.20	4.5	1.1
TRJD475*050#	D	4.7	1.80	4.5	0.9
TRJD685*050#	D	6.8	2.60	4.5	0.7
TRJE106*050#	E	10	3.80	4.5	0.7

# THJ Series



## High Temperature Tantalum Chip Capacitor



The THJ surface mount series combines high temperature operation and higher basic reliability for optimal performance in typical automotive applications. The operational temperature is up to +150°C with derating voltage. The level of reliability of this tantalum product is 0.5% / 1000 hours at rated voltage, rated tempera-

ture and 0.1Ω/volt circuit impedance. The capacitors are produced in black encapsulation with white polarity marking. The THJ series encompasses the 4 case sizes with dimensions identical to TAJ standard series. The voltage range available today is 6.3V through to 35V.

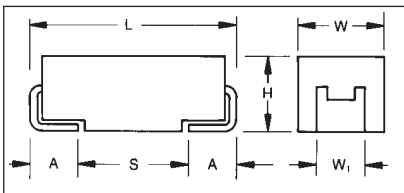

For part marking see page 121

### CASE DIMENSIONS: millimeters (inches)

Code	EIA Code	L±0.20 (0.008)	W+0.20 (0.008) -0.10 (0.004)	H±0.20 (0.008) -0.10 (0.004)	W <sub>1</sub> ±0.20 (0.008)	A+0.30 (0.012) -0.20 (0.008)	S Min.
A	3216-18	3.20 (0.126)	1.60 (0.063)	1.60 (0.063)	1.20 (0.047)	0.80 (0.031)	1.10 (0.043)
B	3528-21	3.50 (0.138)	2.80 (0.110)	1.90 (0.075)	2.20 (0.087)	0.80 (0.031)	1.40 (0.055)
C	6032-28	6.00 (0.236)	3.20 (0.126)	2.60 (0.102)	2.20 (0.087)	1.30 (0.051)	2.90 (0.114)
D	7343-31	7.30 (0.287)	4.30 (0.169)	2.90 (0.114)	2.40 (0.094)	1.30 (0.051)	4.40 (0.173)
E	7343-43	7.30 (0.287)	4.30 (0.169)	4.10 (0.162)	2.40 (0.094)	1.30 (0.051)	4.40 (0.173)

W<sub>1</sub> dimension applies to the termination width for A dimensional area only.

### HOW TO ORDER

**THJ**

Type

**B**

Case Size  
See table above

**105**

Capacitance Code  
pF code: 1st two digits represent significant figures  
3rd digit represents multiplier (number of zeros to follow)

**\***

Tolerance  
K=±10%  
M=±20%

**035**

Rated DC Voltage  
006=6.3Vdc  
010=10Vdc  
016=16Vdc  
020=20Vdc  
025=25Vdc  
035=35Vdc  
050=50Vdc

**R**

Packaging  
R = 7" T/R  
Lead Free  
S = 13" T/R  
Lead Free  
A = Gold Plating  
7" Reel  
B = Gold Plating  
13" Reel

**JN**

Additional characters may be added for special requirements

### TECHNICAL SPECIFICATIONS

Technical Data:	All technical data relate to an ambient temperature of +25°C							
Capacitance Range:	0.1μF to 150μF							
Capacitance Tolerance:	±10%; ±20%							
Rated Voltage (V <sub>R</sub> )	≤ +85°C:	6.3	10	16	20	25	35	50
Category Voltage (V <sub>C</sub> )	≤ +125°C	4	7	10	13	17	23	33
	≤ +150°C	3	5	8	10	12	17	25
Surge Voltage (V <sub>S</sub> )	≤ +85°C	8	13	20	26	32	46	65
	≤ +125°C	5	8	13	16	20	28	40
	≤ +150°C	4	6	10	12	15	21	30
Temperature Range:	Up to 150°C with 50% derating (up to 170°C, 15 hours at 0v)							
Reliability:	0.5% per 1000 hours at 85°C, V <sub>R</sub> with 0.1Ω/V series impedance, 60% confidence level, 3.5 Fits at 40°C, 0.5V <sub>R</sub>							
Termination Finish:	Sn Plating (standard), Gold Plating available on request							
	Meets requirements of AEC-Q200							



# THJ Series



## High Temperature Tantalum Chip Capacitor

### CAPACITANCE AND VOLTAGE RANGE (LETTER DENOTES CASE SIZE)

Capacitance		Rated voltage ( $V_R$ ) to 85°C (Voltage Code)						
$\mu\text{F}$	Code	6.3V (J)	10V (A)	16V (C)	20V (D)	25V (E)	35V (V)	50V (T)
0.10	104						A	
0.15	154						A	
0.22	224						A	
0.33	334						A	
0.47	474					A	B	
0.68	684					A	B	
1.0	105				A	A	A/B	
1.5	155			A			C	
2.2	225			A		B	C	
3.3	335	A	A	A	B		C	D
4.7	475			B			C	
6.8	685			A/B		C	D	
10	106	B		B		C	D	
15	156	B			C		D	
22	226	B	B	C		D	D	
33	336	B	C	C	D	D		
47	476	C		D				
68	686	C		D				
100	107	D	D					
150	157							
220	227							
330	337							
470	477							
680	687							
1000	108							

# THJ Series



## High Temperature Tantalum Chip Capacitor

### RATINGS & PART NUMBER REFERENCE

AVX Part No.	Case Size	Capacitance (μF)	Rated Voltage (V)	DCL (μA) Max.	DF % Max.	ESR Max. (Ω) @ 100 kHz
<b>Voltage Rating 6.3 v @ 85°C (3 v @ 150°C) / J</b>						
THJA475*006#JN	A	4.7	6.3	0.5	6	6
THJB156*006#JN	B	15	6.3	0.9	6	2.5
THJB226*006#JN	B	22	6.3	1.4	6	2.5
THJB336*006#JN	B	33	6.3	1.9	6	1.7
THJC476*006#JN	C	47	6.3	3.0	6	1.6
THJC686*006#JN	C	68	6.3	4.3	6	1.5
THJD157*006#JN	D	150	6.3	9.5	6	0.9
<b>Voltage Rating 10 v @ 85°C (5 v @ 150°C) / A</b>						
THJA335*010#JN	A	3.3	10	0.5	6	5.5
THJB226*010#JN	B	22	10	2.2	6	1.9
THJC336*010#JN	C	33	10	3.3	6	1.6
THJD107*010#JN	D	100	10	10	6	0.9
<b>Voltage Rating 16 v @ 85°C (8 v @ 150°C) / C</b>						
THJA225*016#JN	A	2.2	16	0.5	6	6.5
THJB475*016#JN	B	4.7	16	0.8	6	3.5
THJA335*016#JN	A	3.3	16	0.5	6	3.7
THJA685*016#JN	A	6.8	16	1.1	6	2.6
THJB685*016#JN	B	6.8	16	1.1	6	2.5
THJB106*016#JN	B	10	16	1.6	6	2.8
THJC226*016#JN	C	22	16	3.5	6	1.6
THJC336*016#JN	C	33	16	5.3	6	0.6
THJD476*016#JN	D	47	16	7.5	6	0.9
THJD686*016#JN	D	68	16	10.9	6	0.9
<b>Voltage Rating 20 v @ 85°C (10 v @ 150°C) / D</b>						
THJA155*020#JN	A	1.5	20	0.5	6	6.5
THJB335*020#JN	B	3.3	20	0.7	6	3
THJC156*020#JN	C	15	20	3.0	6	1.7
THJD336*020#JN	D	33	20	6.6	6	0.9

AVX Part No.	Case Size	Capacitance (μF)	Rated Voltage (V)	DCL (μA) Max.	DF % Max.	ESR Max. (Ω) @ 100 kHz
<b>Voltage Rating 25 v @ 85°C (12 v @ 150°C) / E</b>						
THJA474*025#JN	A	0.47	25	0.5	4	14
THJA684*025#JN	A	0.68	25	0.5	4	10
THJA105*025#JN	A	1.0	25	0.5	3	5.2
THJB225*025#JN	B	2.2	25	0.6	6	4.5
THJC685*025#JN	C	6.8	25	1.7	6	2
THJC106*025#JN	C	10	25	2.5	6	1.8
THJD226*025#JN	D	22	25	5.5	6	0.9
<b>Voltage Rating 35 v @ 85°C (17 v @ 150°C) / V</b>						
THJA104*035#JN	A	0.1	35	0.5	4	24
THJA154*035#JN	A	0.15	35	0.5	4	21
THJA224*035#JN	A	0.22	35	0.5	4	18
THJA334*035#JN	A	0.33	35	0.5	4	15
THJB474*035#JN	B	0.47	35	0.5	4	10
THJB684*035#JN	B	0.68	35	0.5	4	8
THJA105*035#JN	A	1.0	35	0.5	4	6.6
THJB105*035#JN	B	1.0	35	0.5	4	6.5
THJC155*035#JN	C	1.5	35	0.5	6	4.5
THJC225*035#JN	C	2.2	35	0.8	6	3.5
THJC335*035#JN	C	3.3	35	1.2	6	2.5
THJC475*035#JN	C	4.7	35	1.6	6	2.2
THJD685*035#JN	D	6.8	35	2.4	6	1.3
THJD106*035#JN	D	10	35	3.5	6	1
THJD156*035#JN	D	15	35	5.3	6	0.9
THJD226*035#JN	D	22	35	7.7	6	0.9
THJD336*035#JN	D	33	35	8.3	6	0.5
<b>Voltage Rating 50 v @ 85°C (25 v @ 150°C) / IT</b>						
THJD475*050#JN	D	4.7	50	2.4	6	1.2

For parametric information on development codes, please contact your local AVX sales office.

All technical data relates to an ambient temperature of +25°C. Capacitance and DF are measured at 120Hz, 0.5V RMS with a maximum DC bias of 2.2 volts. DCL is measured at rated voltage after 5 minutes.

\* Insert K for ±10% and M for ±20%

**NOTE: AVX reserves the right to supply higher specification parts in the same case size, to the same reliability standards.**

# **Standard Plating** – Insert R for 7" reel and S for 13" reel

# **Gold Plating** – Insert A for 7" reel and B for 13" reel

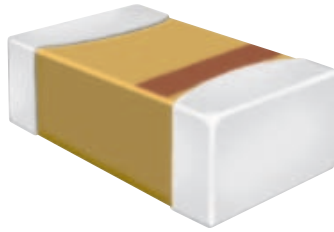

### KEY FEATURES

- Weibull graded
- Reliability 0.1% / k hrs
- Low leakage
- Conformance testing (Lot by Lot)
- Extended traceability
- Approved for use in life support and implantable medical devices



HALOGEN-FREE COMPOUNDS  
ENVIRONMENTAL FRIENDLY COMPONENT

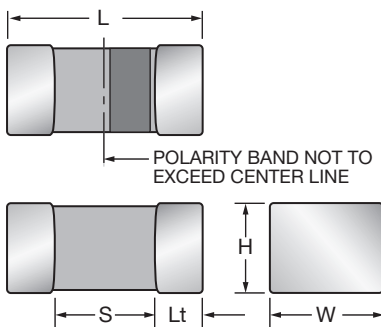

### CASE DIMENSIONS: millimeters (inches)

Code	EIA Code	EIA Metric	Length (L)	Width (W)	Height (H)	Termination Spacing(S)	Minimum Termination Length (Lt)	Average Mass
K	0402	1005-07	1.00 <sup>+0.20</sup> <sub>-0.00</sub> (0.039 <sup>+0.008</sup> <sub>-0.000</sub> )	0.50 <sup>+0.20</sup> <sub>-0.00</sub> (0.020 <sup>+0.008</sup> <sub>-0.000</sub> )	0.50 <sup>+0.20</sup> <sub>-0.00</sub> (0.020 <sup>+0.008</sup> <sub>-0.000</sub> )	0.40 min.	0.10 (0.004)	2.0mg
L	0603	1608-10	1.60 <sup>+0.20</sup> <sub>-0.00</sub> (0.063 <sup>+0.008</sup> <sub>-0.000</sub> )	0.85 <sup>+0.15</sup> <sub>-0.00</sub> (0.033 <sup>+0.006</sup> <sub>-0.000</sub> )	0.85 <sup>+0.15</sup> <sub>-0.00</sub> (0.033 <sup>+0.006</sup> <sub>-0.000</sub> )	0.65 min.	0.15 (0.006)	8.6mg
R	0805	2012-15	2.00 <sup>+0.20</sup> <sub>-0.00</sub> (0.079 <sup>+0.008</sup> <sub>-0.000</sub> )	1.35 <sup>+0.15</sup> <sub>-0.00</sub> (0.053 <sup>+0.006</sup> <sub>-0.000</sub> )	1.35 <sup>+0.15</sup> <sub>-0.00</sub> (0.053 <sup>+0.006</sup> <sub>-0.000</sub> )	0.85 min.	0.15 (0.006)	29.9mg
A	1206	3216-18	3.20±0.20 (0.126±0.008)	1.60±0.20 (0.063±0.008)	1.60±0.20 (0.063±0.008)	2.00 min.	0.15 (0.006)	44.6mg
T	3528	3528-12	3.50 <sup>+0.20</sup> <sub>-0.20</sub> (0.138 <sup>+0.008</sup> <sub>-0.008</sub> )	2.80 <sup>+0.20</sup> <sub>-0.10</sub> (0.110 <sup>+0.008</sup> <sub>-0.004</sub> )	1.20 max. (0.047 max.)	2.30 min.	0.15 (0.006)	65mg

### HOW TO ORDER

<b>TMC</b>	<b>R</b>	<b>106</b>	<b>M</b>	<b>010</b>	<b>E</b>	<b>HS</b>
Type TACmicrochip™	Case Size 0402=K 0603=L 0805=R 1206=A	Capacitance Code pF code: 1st two digits represent significant figures, 3rd digit represents multiplier (number of zeros to follow)	Tolerance K=±10% M=±20%	Rated DC Voltage 002=2Vdc 003=3Vdc 004=4Vdc 006=6.3Vdc 010=10Vdc 016=16Vdc 020=20Vdc	Packaging E = Non Modular qty. supplied on 7" reel	Termination and Special Requirements HS = Tin Termination HR = Gold Termination Alternative characters may be used for special requirements.

### TECHNICAL SPECIFICATIONS

Technical Data:	All technical data relate to an ambient temperature of +25°C							
Capacitance Range:	0.47µF to 68µF							
Capacitance Tolerance:	±10%; ±20%							
Leakage Current DCL:	0.005CV or 0.2µA whichever is the greater							
Rated Voltage (V <sub>R</sub> )	≧ +85°C:	3	4	6.3	10	16	20	
Category Voltage (V <sub>C</sub> )	≧ +125°C:	2	2.7	4	7	10	13	
Surge Voltage (V <sub>S</sub> )	≧ +85°C:	3.9	5.2	8	13	20	26	
Surge Voltage (V <sub>S</sub> )	≧ +125°C:	2.6	3.2	5	8	12	16	
Temperature Range:	-55°C to +125°C							
Reliability:	HRC5000, Weibull B grade, 0.1% per 1,000 hours							
Termination Finish:	Nickel and Tin Plating (standard), Nickel and Gold Plating option available upon request							

### ESTABLISHED RELIABILITY RANGE (EIA Sizes) (LETTER DENOTES CASE SIZE)

Capacitance		Voltage Rating DC (V <sub>R</sub> ) at 85°C						
Cap. (μF)	Code	2.0V	3.0V	4.0V	6.3V	10V	16V	20V
0.33 0.47 0.68	334 474 684					Ⓚ/L K/L	Ⓛ Ⓛ	
1.0 1.5 2.2	105 155 225				K K	K/L L L	L Ⓛ	
3.3 4.7 6.8	335 475 685				L R	L/R L/R R		R
10 15 22	106 156 226		R	R R R	R Ⓡ	R R	R	
33 47 68	336 476 686		R	R A	A	T		
100 150 220	107 157 227							

Developmental Ratings - subject to change

**NOTE:** Encircled letters designate codes where qualification is pending, contact local sales office for current status.

# TAZ Series



## Including CWR09, CWR19, CWR29 and COTS-Plus



The TAZ part has fully molded, compliant leadframe construction designed for use in applications utilizing solder (Reflow, Wave or Vapor Phase), conductive adhesive or thermal compression bonding techniques. Each chip is marked with polarity, capacitance code and rated voltage.

The series comprises ten case sizes (see dimensional chart below) with the maximum size V case giving capacitance values to 470  $\mu$ F. The C case, with its non-standard aspect ratio, is retained as a QPL (Qualified Product List) only special.

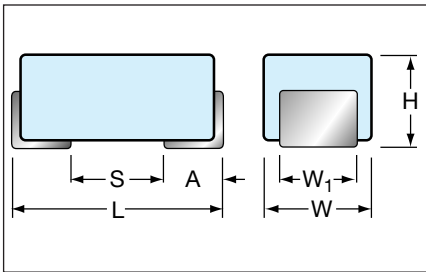

### TAZ & CWR09, CWR19, CWR29 CASE DIMENSIONS:

millimeters (inches)

Case Code	Length (L) $\pm 0.38$ (0.015)	Width (W) $\pm 0.38$ (0.015)	Height (H) $\pm 0.38$ (0.015)	Term. Width (W <sub>1</sub> )	Term. Length (A) $\pm 0.13$ (0.005)	S min
A	2.54 (0.100)	1.27 (0.050)	1.27 (0.050)	1.27 $\pm$ 0.13 (0.050 $\pm$ 0.005)	0.76 (0.030)	0.38 (0.015)
B	3.81 (0.150)	1.27 (0.050)	1.27 (0.050)	1.27 $\pm$ 0.13 (0.050 $\pm$ 0.005)	0.76 (0.030)	1.65 (0.065)
C*	5.08 (0.200)	1.27 (0.050)	1.27 (0.050)	1.27 $\pm$ 0.13 (0.050 $\pm$ 0.005)	0.76 (0.030)	2.92 (0.115)
D	3.81 (0.150)	2.54 (0.100)	1.27 (0.050)	2.41 $\pm$ 0.13/-0.25 (0.095 $\pm$ 0.005/-0.010)	0.76 (0.030)	1.65 (0.065)
E	5.08 (0.200)	2.54 (0.100)	1.27 (0.050)	2.41 $\pm$ 0.13/-0.25 (0.095 $\pm$ 0.005/-0.010)	0.76 (0.030)	2.92 (0.115)
F	5.59 (0.220)	3.43 (0.135)	1.78 (0.070)	3.30 $\pm$ 0.13 (0.130 $\pm$ 0.005)	0.76 (0.030)	3.43 (0.135)
G	6.73 (0.265)	2.79 (0.110)	2.79 (0.110)	2.67 $\pm$ 0.13 (0.105 $\pm$ 0.005)	1.27 (0.050)	3.56 (0.140)
H	7.24 (0.285)	3.81 (0.150)	2.79 (0.110)	3.68 $\pm$ 0.13/-0.51 (0.145 $\pm$ 0.005/-0.020)	1.27 (0.050)	4.06 (0.160)
X**	6.93 Max (0.273)	5.41 Max (0.213)	2.74 Max (0.108)	3.05 $\pm$ 0.13 (0.120 $\pm$ 0.005)	1.19 (0.047)	N/A

### MARKING

(White marking on black body)



**Polarity Stripe (+)**

**Capacitance Code  
Rated Voltage**

\* C case available in CWR09 series only (non standard)

\*\* X case available in CWR19/CWR29 series only

Case sizes A through E share a common (0.050" nom) height profile, compatible with PCMCIA type II applications. These allow downsizing in all portable applications, ranging from sub-miniature hard-disc drive (HDD)/computer to portable communications/GPS systems. The F case at 0.070" nom offers the versatility of a low profile design, while allowing capacitance ratings to 100  $\mu$ F for low voltage filtering applications.

Cases G and H offer lower profile and greater volumetric efficiency than their nearest EIA sized counterparts (ref. CWR11). These are especially suited to power supply applications. The regular configuration allows for banking (brickwalling) applications where maximum capacitance with minimal ESR and inductance are required in a limited board space.

Technical Data:	Unless otherwise specified, all technical data relate to an ambient temperature of 25°C									
Capacitance Range:	0.1 to 470 $\mu$ F									
Capacitance Tolerance:	$\pm 20\%$ , $\pm 10\%$ , $\pm 5\%$									
Rated DC Voltage: (V <sub>R</sub> )	$\leq 85^\circ\text{C}$ :	4	6	10	16	20	25	35	50	
Category Voltage: (V <sub>C</sub> )	125°C:	2.7	4	7	10	13	17	23	33	
Surge Voltage: (V <sub>S</sub> )	$\leq 85^\circ\text{C}$ :	5.2	8	13	20	26	33	46	65	
	125°C:	3.5	5	9	12	16	21	28	40	
Operating Temperature Range:	-55°C to +125°C									

## CWR09

### CWR09 - MIL-PRF-55365/4

Fully qualified to MIL-PRF-55365/4, this series represents the most flexible of surface mount form factors, offering eight case sizes (A through H). This series is fully interchangeable with CWR06 conformal types, while offering the advantages of molded body/compliant termination construction, polarity and capacitance. The molded construction is compatible with a wide range of SMT board assembly processes including wave or reflow solder, conductive epoxy or compression bonding techniques. The five smaller cases are characterized

by their low profile construction, with the A case being the world's smallest molded military tantalum. There are three termination finishes available: fused solder plated ("K" per MIL-PRF-55365), hot solder dipped ("C") and gold plated ("B"). In addition, the molding compound has been selected to meet the requirements of UL94V-0 and outgassing requirements of NASA SP-R-0022A.

### PART NUMBERING SYSTEM



### ORIGINAL RANGE - TAZ PROFESSIONAL AND CWR09 MILITARY (MIL PRF-55365/4)

Capacitance and Voltage Range (letter denotes case size)									
Capacitance		Rated voltage DC (V <sub>R</sub> ) at 85°C							
µF	Code	4V	6V	10V	15V	20V	25V	35V	50V
0.1	104								A
0.15	154								A
0.22	224							A	B
0.33	334						A		B
0.47	474					A		B	C
0.68	684				A	B	B	C	D
1.0	105			A		B	C	D	E
1.5	155		A		B	C	D	E	F
2.2	225	A		B	C	D	E		F
3.3	335		B	C	D	E		F	G
4.7	475	B	C	D	E		F	G	H
6.8	685	C	D	E		F	G	H	
10	106	D	E		F		G		
15	156	E		F		G	H		
22	226		F		G	H			
33	336	F		G	H				
47	476		G	H					
68	686	G	H						
100	107	H							

NOTE: TAZ Standard Range ratings are also available as CWR09 Military parts, see page 52.

# Surface Mount Military



## CWR09 - MIL-PRF-55365/4 and TAZ COTS-Plus

AVX Part Number	QPL Part Number (for reference only)	DC rated voltage (85°C) (volts)	Cap (nom) µF	DC Leakage (max)			Dissipation Factor (max)			ESR (max) 100 kHz +25°C (Ohms)	Case Size
				+25°C (µA)	+85°C (µA)	+125°C (µA)	+25°C (%)	+85/125°C (%)	-55°C (%)		
TAZA225*004C□#@0^++	CWR09C^225*@+□	4	2.2	1.0	10	12	6	8	8	8.0	A
TAZB475*004C□#@0^++	CWR09C^475*@+□	4	4.7	1.0	10	12	6	8	8	8.0	B
TAZC685*004C□#@0^++	CWR09C^685*@+□	4	6.8	1.0	10	12	6	8	8	5.5	C
TAZD106*004C□#@0^++	CWR09C^106*@+□	4	10.0	1.0	10	12	8	8	10	4.0	D
TAZE156*004C□#@0^++	CWR09C^156*@+□	4	15.0	1.0	10	12	8	10	12	3.5	E
TAZF336*004C□#@0^++	CWR09C^336*@+□	4	33.0	2.0	20	24	8	10	12	2.2	F
TAZG686*004C□#@0^++	CWR09C^686*@+□	4	68.0	3.0	30	36	10	12	12	1.1	G
TAZH107*004C□#@0^++	CWR09C^107*@+□	4	100.0	4.0	40	48	10	12	12	0.9	H
TAZA155*006C□#@0^++	CWR09D^155*@+□	6	1.5	1.0	10	12	6	8	8	8.0	A
TAZB335*006C□#@0^++	CWR09D^335*@+□	6	3.3	1.0	10	12	6	8	8	8.0	B
TAZC475*006C□#@0^++	CWR09D^475*@+□	6	4.7	1.0	10	12	6	8	8	5.5	C
TAZD685*006C□#@0^++	CWR09D^685*@+□	6	6.8	1.0	10	12	6	8	8	4.5	D
TAZE106*006C□#@0^++	CWR09D^106*@+□	6	10.0	1.0	10	12	8	10	12	3.5	E
TAZF226*006C□#@0^++	CWR09D^226*@+□	6	22.0	2.0	20	24	8	10	12	2.2	F
TAZG476*006C□#@0^++	CWR09D^476*@+□	6	47.0	3.0	30	36	10	12	12	1.1	G
TAZH686*006C□#@0^++	CWR09D^686*@+□	6	68.0	4.0	40	48	10	12	12	0.9	H
TAZA105*010C□#@0^++	CWR09F^105*@+□	10	1.0	1.0	10	12	6	8	8	10.0	A
TAZB225*010C□#@0^++	CWR09F^225*@+□	10	2.2	1.0	10	12	6	8	8	8.0	B
TAZC335*010C□#@0^++	CWR09F^335*@+□	10	3.3	1.0	10	12	6	8	8	5.5	C
TAZD475*010C□#@0^++	CWR09F^475*@+□	10	4.7	1.0	10	12	6	8	8	4.5	D
TAZE685*010C□#@0^++	CWR09F^685*@+□	10	6.8	1.0	10	12	6	8	8	3.5	E
TAZF156*010C□#@0^++	CWR09F^156*@+□	10	15.0	2.0	20	24	8	8	10	2.5	F
TAZG336*010C□#@0^++	CWR09F^336*@+□	10	33.0	3.0	30	36	10	12	12	1.1	G
TAZH476*010C□#@0^++	CWR09F^476*@+□	10	47.0	5.0	50	60	10	12	12	0.9	H
TAZA684*015C□#@0^++	CWR09H^684*@+□	15	0.68	1.0	10	12	6	8	8	12.0	A
TAZB155*015C□#@0^++	CWR09H^155*@+□	15	1.5	1.0	10	12	6	8	8	8.0	B
TAZC225*015C□#@0^++	CWR09H^225*@+□	15	2.2	1.0	10	12	6	8	8	5.5	C
TAZD335*015C□#@0^++	CWR09H^335*@+□	15	3.3	1.0	10	12	6	8	8	5.0	D
TAZE475*015C□#@0^++	CWR09H^475*@+□	15	4.7	1.0	10	12	6	8	8	4.0	E
TAZF106*015C□#@0^++	CWR09H^106*@+□	15	10.0	2.0	20	24	6	8	8	2.5	F
TAZG226*015C□#@0^++	CWR09H^226*@+□	15	22.0	4.0	40	48	6	8	8	1.1	G
TAZH336*015C□#@0^++	CWR09H^336*@+□	15	33.0	5.0	50	60	8	8	10	0.9	H
TAZA474*020C□#@0^++	CWR09J^474*@+□	20	0.47	1.0	10	12	8	10	10	14.0	A
TAZB684*020C□#@0^++	CWR09J^684*@+□	20	0.68	1.0	10	12	6	8	8	10.0	B
TAZB105*020C□#@0^++	CWR09J^105*@+□	20	1.0	1.0	10	12	6	8	8	12.0	B
TAZC155*020C□#@0^++	CWR09J^155*@+□	20	1.5	1.0	10	12	6	8	8	6.0	C
TAZD225*020C□#@0^++	CWR09J^225*@+□	20	2.2	1.0	10	12	6	8	8	5.0	D
TAZE335*020C□#@0^++	CWR09J^335*@+□	20	3.3	1.0	10	12	6	8	8	4.0	E
TAZF685*020C□#@0^++	CWR09J^685*@+□	20	6.8	2.0	20	24	6	8	8	2.4	F
TAZG156*020C□#@0^++	CWR09J^156*@+□	20	15.0	3.0	30	36	6	8	8	1.1	G
TAZH226*020C□#@0^++	CWR09J^226*@+□	20	22.0	4.0	40	48	6	8	8	0.9	H

Following the voltage code, C designates Standard, L designates Low ESR Ratings

CWR19, CWR29 DESIGNATIONS ARE INCLUDED FOR REFERENCE ONLY – USE TAZ P/N TO ORDER

### Part Number Designations

**^ = Termination Finish:**<sup>1</sup>  
For TAZ p/n:

9 = Gold Plated  
8 = Hot Solder Dipped  
0 = Solder Fused

For CWR p/n:  
B = Gold Plated  
C = Hot Solder Dipped  
K = Solder Fused

**# = Inspection Level:**

S = Std. Conformance  
L = Group A

For CWR p/n:  
M = Military  
Conformance per  
MIL-PRF-55365

**\* = Tolerance:**

M = ±20%  
K = ±10%  
J = ±5% (Special  
order only)

**@ = Failure Rate Level:**

Weibull: B = 0.1%/1000 Hrs.  
(90% C = 0.01%/1000 Hrs.  
conf.)  
Comm: Z = Non ER

**+ = Surge Option:**

For TAZ p/n:  
00 = None  
23 = 10 cycles, +25°C  
24 = 10 cycles, -55°C & +85°C  
45 = 10 cycles, -55°C & +85°C before Weibull  
For CWR p/n:  
A = 10 cycles, +25°C  
B = 10 cycles, -55°C & +85°C  
C = 10 cycles, -55°C & +85°C before Weibull  
Z = None (required for CWR19 & CWR29 only)

**□ = Packaging:**

For TAZ p/n:  
B = Bulk  
R = 7" T&R  
S = 13" T&R  
For CWR p/n:  
Bulk = Standard  
TR = 7" T&R  
TR13 = 13" T&R  
W = Waffle

# Surface Mount Military



## CWR09 - MIL-PRF-55365/4 and TAZ COTS-Plus

AVX Part Number	QPL Part Number (for reference only)	DC rated voltage (85°C) (volts)	Cap (nom) µF	DC Leakage (max)			Dissipation Factor (max)			ESR (max) 100 kHz +25°C (Ohms)	Case Size
				+25°C (µA)	+85°C (µA)	+125°C (µA)	+25°C (%)	+85/125°C (%)	-55°C (%)		
TAZA334*020C□#@0^++	CWR09K^334*@+□	25	0.33	1.0	10	12	6	8	8	15.0	A
TAZB684*020C□#@0^++	CWR09K^684*@+□	25	0.68	1.0	10	12	6	8	8	7.5	B
TAZC105*025C□#@0^++	CWR09K^105*@+□	25	1.0	1.0	10	12	6	8	8	6.5	C
TAZD155*020C□#@0^++	CWR09K^155*@+□	25	1.5	1.0	10	12	6	8	8	6.5	D
TAZE225*020C□#@0^++	CWR09K^225*@+□	25	2.2	1.0	10	12	6	8	8	3.5	E
TAZF475*020C□#@0^++	CWR09K^475*@+□	25	4.7	2.0	20	24	6	8	8	2.5	F
TAZG685*020C□#@0^++	CWR09K^685*@+□	25	6.8	2.0	20	24	6	8	8	1.2	G
TAZG106*020C□#@0^++	CWR09K^106*@+□	25	10.0	3.0	30	36	6	8	8	1.4	G
TAZH156*020C□#@0^++	CWR09K^156*@+□	25	15.0	4.0	40	48	6	8	8	1.0	H
TAZA224*035C□#@0^++	CWR09M^224*@+□	35	0.22	1.0	10	12	6	8	8	18.0	A
TAZB474*035C□#@0^++	CWR09M^474*@+□	35	0.47	1.0	10	12	6	8	8	10.0	B
TAZC684*035C□#@0^++	CWR09M^684*@+□	35	0.68	1.0	10	12	6	8	8	8.0	C
TAZD105*035C□#@0^++	CWR09M^105*@+□	35	1.0	1.0	10	12	6	8	8	6.5	D
TAZE155*035C□#@0^++	CWR09M^155*@+□	35	1.5	1.0	10	12	6	8	8	4.5	E
TAZF335*035C□#@0^++	CWR09M^335*@+□	35	3.3	1.0	10	12	6	8	8	2.5	F
TAZG475*035C□#@0^++	CWR09M^475*@+□	35	4.7	2.0	20	24	6	8	8	1.5	G
TAZH685*035C□#@0^++	CWR09M^685*@+□	35	6.8	3.0	30	36	6	8	8	1.3	H
TAZA104*050C□#@0^++	CWR09N^104*@+□	50	0.10	1.0	10	12	6	8	8	22.0	A
TAZA154*050C□#@0^++	CWR09N^154*@+□	50	0.15	1.0	10	12	6	8	8	17.0	A
TAZB224*050C□#@0^++	CWR09N^224*@+□	50	0.22	1.0	10	12	6	8	8	14.0	B
TAZB334*050C□#@0^++	CWR09N^334*@+□	50	0.33	1.0	10	12	6	8	8	12.0	B
TAZC474*050C□#@0^++	CWR09N^474*@+□	50	0.47	1.0	10	12	6	8	8	8.0	C
TAZD684*050C□#@0^++	CWR09N^684*@+□	50	0.68	1.0	10	12	6	8	8	7.0	D
TAZE105*050C□#@0^++	CWR09N^105*@+□	50	1.0	1.0	10	12	6	8	8	6.0	E
TAZF155*050C□#@0^++	CWR09N^155*@+□	50	1.5	1.0	10	12	6	8	8	4.0	F
TAZF225*050C□#@0^++	CWR09N^225*@+□	50	2.2	2.0	20	24	6	8	8	2.5	F
TAZG335*050C□#@0^++	CWR09N^335*@+□	50	3.3	2.0	20	24	6	8	8	2.0	G
TAZH475*050C□#@0^++	CWR09N^475*@+□	50	4.7	3.0	30	36	6	8	8	1.5	H

Following the voltage code, C designates Standard, L designates Low ESR Ratings

CWR19, CWR29 DESIGNATIONS ARE INCLUDED FOR REFERENCE ONLY – USE TAZ P/N TO ORDER

### Part Number Designations

**^ = Termination Finish:**<sup>1</sup>

**For TAZ p/n:**

9 = Gold Plated  
8 = Hot Solder Dipped  
0 = Solder Fused

**For CWR p/n:**

B = Gold Plated  
C = Hot Solder Dipped  
K = Solder Fused

**# = Inspection Level:**

S = Std. Conformance

L = Group A

**For CWR p/n:**

M = Military  
Conformance per  
MIL-PRF-55365

**\* = Tolerance:**

M = ±20%

K = ±10%

J = ±5% (Special  
order only)

**@ = Failure Rate Level:**

Weibull: B = 0.1%/1000 Hrs.

(90% C = 0.01%/1000 Hrs.

conf.)  
Comm: Z = Non ER

**+ = Surge Option:**

**For TAZ p/n:**

00 = None  
23 = 10 cycles, +25°C  
24 = 10 cycles, -55°C & +85°C  
45 = 10 cycles, -55°C & +85°C before Weibull

**For CWR p/n:**

A = 10 cycles, +25°C  
B = 10 cycles, -55°C & +85°C  
C = 10 cycles, -55°C & +85°C before Weibull  
Z = None (required for CWR19 & CWR29 only)

**□ = Packaging:**

**For TAZ p/n:**

B = Bulk  
R = 7" T&R  
S = 13" T&R

**For CWR p/n:**

Bulk = Standard  
TR = 7" T&R  
TR13 = 13" T&R  
W = Waffle



# Surface Mount Military



## CWR19

### CWR19 - MIL-PRF-55365/11

An extended range of capacitor ratings beyond CWR09 that is fully qualified to MIL-PRF-55365/11, this series represents the most flexible of surface mount form factors, offering nine case sizes. The molded construction is compatible with a wide range of SMT board assembly processes including wave or reflow solder, conductive epoxy or compression bonding techniques. The five smaller cases are characterized

by their low profile construction; with the A case being the world's smallest molded military tantalum. There are three termination finishes available: fused solder plated ("K" per MIL-PRF-55365), hot solder dipped ("C") and gold plated ("B"). In addition, the molding compound has been selected to meet the requirements of UL94V-0 (Flame Retardancy) and requirements of NASA SP-R-0022A (Outgassing).

### PART NUMBERING SYSTEM

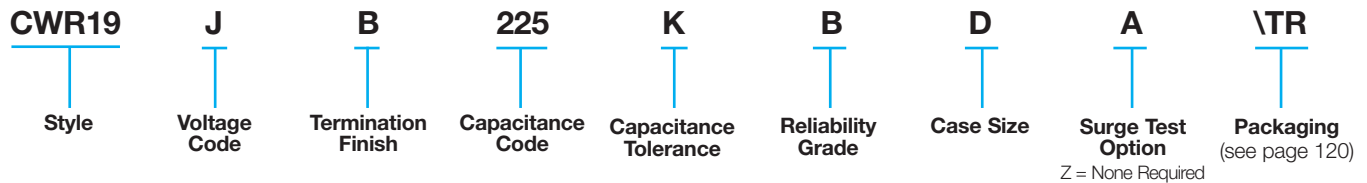

### EXTENDED RANGE - TAZ PROFESSIONAL AND CWR19 MILITARY (MIL PRF-55365/11)

Capacitance and Voltage Range (letter denotes case size)									
Capacitance		Rated voltage DC (V <sub>R</sub> ) at 85°C (Voltage Code)							
µF	Code	4V(C)	6.3V(D)	10V(F)	15V(H)	20V(J)	25V(K)	35V(M)	50V(N)
0.33	334						A	A	C
0.47	474						A		
0.68	684					A		C	
1.0	105				A	A	B/C		
1.5	155				A	B/C			
2.2	225			A	A/C	B	D		
3.3	335	A	A	A/C	B	D	E		
4.7	475	A	A/C	B/C	B/C/D	E			
6.8	685	A/C	B	B/C/D	D/E	E	F	G	
10	106	B	B	B/C/D/E	D/E	E/F		H	
15	156	B	B/D/E	D/E	E/F	F	G	X	
22	226	B/D	D/E	E	F	G	G/H/X		
33	336	D/E	E	F	F/G	H	H/X		
47	476	E	F	F/G	G/H	H/X			
68	686	E	F/G	G	G/H				
100	107	F	G	G/H	H				
150	157	G	G	H/X					
220	227	G	H	H					
330	337	H	H						



# Surface Mount Military



## TAZ Professional and CWR19 - MIL-PRF-55365/11

AVX Part Number	QPL Part Number	DC rated voltage (85°C) (volts)	Cap (nom) μF	DC Leakage (max)			Dissipation Factor (max)			ESR (max) 100 kHz +25°C (Ohms)	Case Size
				+25°C (μA)	+85°C (μA)	+125°C (μA)	+25°C (%)	+85/125°C (%)	-55°C (%)		
TAZA335*004C#@0^++	CWR19C-335*@A+□	4	3.3	1	10	12	6	8	8	12	A
TAZA475*004C#@0^++	CWR19C-475*@A+□	4	4.7	1	10	12	6	8	8	12	A
TAZA685*004C#@0^++	CWR19C-685*@A+□	4	6.8	1	10	12	6	8	8	12	A
TAZC685*004C#@0^++	CWR19C-685*@C+□	4	6.8	1	10	12	6	8	8	5.5	C
TAZB106*004C#@0^++	CWR19C-106*@B+□	4	10	1	10	12	8	10	10	8	B
TAZB156*004C#@0^++	CWR19C-156*@B+□	4	15	1	10	12	8	10	10	8	B
TAZB226*004C#@0^++	CWR19C-226*@B+□	4	22	1	10	12	8	10	10	8	B
TAZD226*004C#@0^++	CWR19C-226*@D+□	4	22	1	10	12	8	10	12	4	D
TAZD336*004C#@0^++	CWR19C-336*@D+□	4	33	2	20	24	8	10	12	4	D
TAZE336*004C#@0^++	CWR19C-336*@E+□	4	33	2	20	24	8	10	12	3	E
TAZE476*004C#@0^++	CWR19C-476*@E+□	4	47	2	20	24	8	10	12	3	E
TAZE686*004C#@0^++	CWR19C-686*@E+□	4	68	3	30	36	8	10	12	3	E
TAZF107*004C#@0^++	CWR19C-107*@F+□	4	100	4	40	48	10	12	12	2	F
TAZG157*004C#@0^++	CWR19C-157*@G+□	4	150	6	60	72	10	12	12	1	G
TAZG227*004C#@0^++	CWR19C-227*@G+□	4	220	8	80	96	10	12	12	1	G
TAZH337*004C#@0^++	CWR19C-337*@H+□	4	330	10	100	120	10	12	12	0.9	H
TAZA335*006C#@0^++	CWR19D-335*@A+□	6	3.3	1	10	12	6	8	8	12	A
TAZA475*006C#@0^++	CWR19D-475*@A+□	6	4.7	1	10	12	6	8	8	12	A
TAZC475*006C#@0^++	CWR19D-475*@C+□	6	4.7	1	10	12	6	8	8	5.5	C
TAZB685*006C#@0^++	CWR19D-685*@B+□	6	6.8	1	10	12	6	8	8	8	B
TAZB106*006C#@0^++	CWR19D-106*@B+□	6	10	1	10	12	6	8	8	8	B
TAZB156*006C#@0^++	CWR19D-156*@B+□	6	15	1	10	12	8	10	10	8	B
TAZD156*006C#@0^++	CWR19D-156*@D+□	6	15	1	10	12	8	10	12	5	D
TAZE156*006C#@0^++	CWR19D-156*@E+□	6	15	1	10	12	8	10	12	3	E
TAZD226*006C#@0^++	CWR19D-226*@D+□	6	22	1	10	12	6	8	8	5	D
TAZD226*006C#@0^++	CWR19D-226*@E+□	6	22	2	20	24	8	10	12	3.5	E
TAZE336*006C#@0^++	CWR19D-336*@E+□	6	33	2	20	24	6	8	8	3.5	E
TAZF476*006C#@0^++	CWR19D-476*@F+□	6	47	3	30	36	8	10	12	3.5	F
TAZF686*006C#@0^++	CWR19D-686*@F+□	6	68	4	40	48	10	12	12	1.5	F
TAZG686*006C#@0^++	CWR19D-686*@G+□	6	68	4	40	48	10	12	12	1	G
TAZG107*006C#@0^++	CWR19D-107*@G+□	6	100	6	60	72	10	12	12	1.1	G
TAZG157*006C#@0^++	CWR19D-157*@G+□	6	150	10	100	120	10	12	12	1.1	G
TAZH227*006C#@0^++	CWR19D-227*@H+□	6	220	10	100	120	10	12	12	0.9	H
TAZH337*006C#@0^++	CWR19D-337*@H+□	6	330	20	200	240	10	12	12	0.9	H
TAZA225*010C#@0^++	CWR19F-225*@A+□	10	2.2	1	10	12	6	8	8	12	A
TAZA335*010C#@0^++	CWR19F-335*@A+□	10	3.3	1	10	12	6	8	8	12	A
TAZC335*010C#@0^++	CWR19F-335*@C+□	10	3.3	1	10	12	6	8	8	5.5	C
TAZB475*010C#@0^++	CWR19F-475*@B+□	10	4.7	1	10	12	6	8	8	8	B
TAZC475*010C#@0^++	CWR19F-475*@C+□	10	4.7	1	10	12	6	8	8	5.5	C
TAZB685*010C#@0^++	CWR19F-685*@B+□	10	6.8	1	10	12	6	8	8	8	B
TAZC685*010C#@0^++	CWR19F-685*@C+□	10	6.8	1	10	12	6	8	8	5.5	C
TAZD685*010C#@0^++	CWR19F-685*@D+□	10	6.8	1	10	12	6	8	8	5	D
TAZB106*010C#@0^++	CWR19F-106*@B+□	10	10	1	10	12	8	10	10	8	B

Following the voltage code, C designates Standard, L designates Low ESR Ratings

CWR19, CWR29 DESIGNATIONS ARE INCLUDED FOR REFERENCE ONLY – USE TAZ P/N TO ORDER

### Part Number Designations

**\* = Tolerance:**

M = ±20%  
K = ±10%  
J = ±5% (Special order only)

**# = Inspection Level:**

S = Std. Conformance  
L = Group A  
**For CWR p/n:**  
M = Military Conformance per MIL-PRF-55365

**@ = Failure Rate Level:**

Weibull: B = 0.1%/1000 Hrs. (90% C = 0.01%/1000 Hrs. conf.)  
Comm: Z = Non ER

**+ = Surge Option:**

**For TBJ p/n:**  
00 = None  
23 = 10 cycles, +25°C  
24 = 10 cycles, -55°C & +85°C  
45 = 10 cycles, -55°C & +85°C before Weibull  
**For CWR p/n:**  
A = 10 cycles, +25°C  
B = 10 cycles, -55°C & +85°C  
C = 10 cycles, -55°C & +85°C before Weibull  
Z = None (required for CWR19 & CWR29 only)

**□ = Packaging:**

**For TBJ p/n:**  
B = Bulk  
R = 7" T&R  
S = 13" T&R  
**For CWR p/n:**  
Bulk = Standard  
VTR = 7" T&R  
VTR13 = 13" T&R  
W = Waflle



# Surface Mount Military



## TAZ Professional and CWR19 - MIL-PRF-55365/11

AVX Part Number	QPL Part Number	DC rated voltage (85°C) (volts)	Cap (nom) μF	DC Leakage (max)			Dissipation Factor (max)			ESR (max) 100 kHz +25°C (Ohms)	Case Size
				+25°C (μA)	+85°C (μA)	+125°C (μA)	+25°C (%)	+85/125°C (%)	-55°C (%)		
TAZC106*010C#@0^++	CWR19F-106*@C+□	10	10	1	10	12	6	8	8	5.5	C
TAZD106*010C#@0^++	CWR19F-106*@D+□	10	10	1	10	12	6	8	8	4	D
TAZE106*010C#@0^++	CWR19F-106*@E+□	10	10	1	10	12	6	8	8	3.5	E
TAZD156*010C#@0^++	CWR19F-156*@D+□	10	15	2	20	24	6	8	8	5	D
TAZE156*010C#@0^++	CWR19F-156*@E+□	10	15	2	20	24	8	10	10	3	E
TAZE226*010C#@0^++	CWR19F-226*@E+□	10	22	3	30	36	8	10	10	2	E
TAZF336*010C#@0^++	CWR19F-336*@F+□	10	33	3	30	36	8	10	10	1.5	F
TAZF476*010C#@0^++	CWR19F-476*@F+□	10	47	4	40	48	10	12	12	1.5	F
TAZG476*010C#@0^++	CWR19F-476*@G+□	10	47	4	40	48	10	12	12	1	G
TAZG686*010C#@0^++	CWR19F-686*@G+□	10	68	6	60	72	10	12	12	1.1	G
TAZG107*010C#@0^++	CWR19F-107*@G+□	10	100	10	100	120	10	12	12	1.1	G
TAZH107*010C#@0^++	CWR19F-107*@H+□	10	100	10	100	120	10	12	12	0.9	H
TAZH157*010C#@0^++	CWR19F-157*@H+□	10	150	15	150	180	10	12	12	0.9	H
TAZH157*010C#@0^++	CWR19F-157*@X+□	10	150	15	150	180	10	12	12	0.9	X
TAZH227*010C#@0^++	CWR19F-227*@H+□	10	220	20	200	240	10	12	12	0.9	H
TAZA105*015C#@0^++	CWR19H-105*@A+□	15	1	1	10	12	6	8	8	15	A
TAZA155*015C#@0^++	CWR19H-155*@A+□	15	1.5	1	10	12	6	8	8	15	A
TAZA225*015C#@0^++	CWR19H-225*@A+□	15	2.2	1	10	12	6	8	8	15	A
TAZC225*015C#@0^++	CWR19H-225*@C+□	15	2.2	1	10	12	6	8	8	5.5	C
TAZB335*015C#@0^++	CWR19H-335*@B+□	15	3.3	1	10	12	6	8	8	9	B
TAZB475*015C#@0^++	CWR19H-475*@B+□	15	4.7	1	10	12	6	8	8	5	B
TAZC475*015C#@0^++	CWR19H-475*@C+□	15	4.7	1	10	12	6	8	8	5.5	C
TAZD475*015C#@0^++	CWR19H-475*@D+□	15	4.7	1	10	12	6	8	8	6	D
TAZD685*015C#@0^++	CWR19H-685*@D+□	15	6.8	1	10	12	6	8	8	6	D
TAZE685*015C#@0^++	CWR19H-685*@E+□	15	6.8	1	10	12	8	10	12	3	E
TAZD106*015C#@0^++	CWR19H-106*@D+□	15	10	2	20	24	6	8	8	6	D
TAZE106*015C#@0^++	CWR19H-106*@E+□	15	10	2	20	24	6	8	8	4	E
TAZE156*015C#@0^++	CWR19H-156*@E+□	15	15	2	20	24	6	8	8	4	E
TAZF156*015C#@0^++	CWR19H-156*@F+□	15	15	2	20	24	8	10	10	3	F
TAZF226*015C#@0^++	CWR19H-226*@F+□	15	22	3	30	36	8	10	10	3	F
TAZF336*015C#@0^++	CWR19H-336*@F+□	15	33	5	50	60	6	8	8	3	F
TAZG336*015C#@0^++	CWR19H-336*@G+□	15	33	6	60	72	8	10	10	1.1	G
TAZG476*015C#@0^++	CWR19H-476*@G+□	15	47	10	100	120	8	10	10	1.1	G
TAZH476*015C#@0^++	CWR19H-476*@H+□	15	47	10	100	120	8	10	10	0.9	H
TAZG686*015C#@0^++	CWR19H-686*@G+□	15	68	10	100	120	8	10	10	1.1	G
TAZH686*015C#@0^++	CWR19H-686*@H+□	15	68	10	100	120	8	10	10	0.9	H
TAZH107*015C#@0^++	CWR19H-107*@H+□	15	100	15	150	180	10	12	12	0.9	H
TAZA684*020C#@0^++	CWR19J-684*@A+□	20	0.68	1	10	12	6	8	8	15	A
TAZA105*020C#@0^++	CWR19J-105*@A+□	20	1	1	10	12	6	8	8	15	A
TAZB155*020C#@0^++	CWR19J-155*@B+□	20	1.5	1	10	12	6	8	8	9	B
TAZC155*020C#@0^++	CWR19J-155*@C+□	20	1.5	1	10	12	6	8	8	6	C
TAZB225*020C#@0^++	CWR19J-225*@B+□	20	2.2	1	10	12	6	8	8	9	B
TAZD335*020C#@0^++	CWR19J-335*@D+□	20	3.3	1	10	12	6	8	8	6	D

Following the voltage code, C designates Standard, L designates Low ESR Ratings

CWR19, CWR29 DESIGNATIONS ARE INCLUDED FOR REFERENCE ONLY – USE TAZ P/N TO ORDER

### Part Number Designations

**^ = Termination Finish:**  
**For TAZ p/n:**  
 9 = Gold Plated  
 8 = Hot Solder Dipped  
 0 = Solder Fused  
**For CWR p/n:**  
 B = Gold Plated  
 C = Hot Solder Dipped  
 K = Solder Fused

**# = Inspection Level:**  
 S = Std. Conformance  
 L = Group A  
**For CWR p/n:**  
 M = Military  
 Conformance per MIL-PRF-55365

**\* = Tolerance:**  
 M = ±20%  
 K = ±10%  
 J = ±5% (Special order only)

**@ = Failure Rate Level:**  
 Weibull: B = 0.1%/1000 Hrs.  
 (90% C = 0.01%/1000 Hrs. conf.)  
 Comm: Z = Non ER

**+ = Surge Option:**  
**For TAZ p/n:**  
 00 = None  
 23 = 10 cycles, +25°C  
 24 = 10 cycles, -55°C & +85°C  
 45 = 10 cycles, -55°C & +85°C before Weibull  
**For CWR p/n:**  
 A = 10 cycles, +25°C  
 B = 10 cycles, -55°C & +85°C  
 C = 10 cycles, -55°C & +85°C before Weibull  
 Z = None (required for CWR19 & CWR29 only)

**□ = Packaging:**  
**For TAZ p/n:**  
 B = Bulk  
 R = 7" T&R  
 S = 13" T&R  
**For CWR p/n:**  
 Bulk = Standard  
 \TR = 7" T&R  
 \TR13 = 13" T&R  
 \W = Waffle



# Surface Mount Military



## TAZ Professional and CWR19 - MIL-PRF-55365/11

AVX Part Number	QPL Part Number	DC rated voltage (85°C) (volts)	Cap (nom) $\mu$ F	DC Leakage (max)			Dissipation Factor (max)			ESR (max) 100 kHz +25°C (Ohms)	Case Size
				+25°C ( $\mu$ A)	+85°C ( $\mu$ A)	+125°C ( $\mu$ A)	+25°C (%)	+85/125°C (%)	-55°C (%)		
TAZE475*020C#@0^++	CWR19J-475*@E+□	20	4.7	1	10	12	6	8	8	6	E
TAZE685*020C#@0^++	CWR19J-685*@E+□	20	6.8	2	20	24	6	8	8	5	E
TAZE106*020C#@0^++	CWR19J-106*@E+□	20	10	2	20	24	6	8	8	5	E
TAZF106*020C#@0^++	CWR19J-106*@F+□	20	10	2	20	24	6	8	8	3	F
TAZF156*020C#@0^++	CWR19J-156*@F+□	20	15	3	30	36	6	8	8	3	F
TAZG226*020C#@0^++	CWR19J-226*@G+□	20	22	4	40	48	6	8	8	2.5	G
TAZH336*020C#@0^++	CWR19J-336*@H+□	20	33	6	60	72	8	10	10	0.9	H
TAZH476*020C#@0^++	CWR19J-476*@H+□	20	47	10	100	120	8	10	10	0.9	H
TAZX476*020C#@0^++	CWR19J-476*@X+□	20	47	10	100	120	8	10	10	0.9	X
TAZA474*025C#@0^++	CWR19K-474*@A+□	25	0.47	1	10	12	6	8	8	15	A
TAZB105*025C#@0^++	CWR19K-105*@B+□	25	1	1	10	12	6	8	8	10	B
TAZC105*025C#@0^++	CWR19K-105*@C+□	25	1	1	10	12	6	8	8	6.5	C
TAZD225*025C#@0^++	CWR19K-225*@D+□	25	2.2	1	10	12	6	8	8	6	D
TAZE335*025C#@0^++	CWR19K-335*@E+□	25	3.3	1	10	12	6	8	8	4	E
TAZF685*025C#@0^++	CWR19K-685*@F+□	25	6.8	2	20	24	6	8	8	3	F
TAZG156*025C#@0^++	CWR19K-156*@G+□	25	15	4	40	48	6	8	8	1.4	G
TAZG226*025C#@0^++	CWR19K-226*@G+□	25	22	6	60	72	6	8	8	1.4	G
TAZH226*025C#@0^++	CWR19K-226*@H+□	25	22	6	60	72	6	8	8	0.9	H
TAZX226*025C#@0^++	CWR19K-226*@X+□	25	22	6	60	72	6	8	8	0.9	X
TAZH336*025C#@0^++	CWR19K-336*@H+□	25	33	10	100	120	8	10	10	0.9	H
TAZX336*025C#@0^++	CWR19K-336*@X+□	25	33	10	100	120	8	10	10	0.9	X
TAZA334*035C#@0^++	CWR19M-334*@A+□	35	0.33	1	10	12	6	8	8	22	A
TAZC684*035C#@0^++	CWR19M-684*@C+□	35	0.68	1	10	12	6	8	8	10	C
TAZG685*035C#@0^++	CWR19M-685*@G+□	35	6.8	3	30	36	6	8	8	1.5	G
TAZH106*035C#@0^++	CWR19M-106*@H+□	35	10	4	40	48	8	10	10	0.9	H
TAZX156*035C#@0^++	CWR19M-156*@X+□	35	15	6	60	72	6	8	8	0.9	X
TAZC474*050C#@0^++	CWR19N-474*@C+□	50	0.47	1	10	12	6	8	8	8	C

Following the voltage code, C designates Standard, L designates Low ESR Ratings

CWR19, CWR29 DESIGNATIONS ARE INCLUDED FOR REFERENCE ONLY – USE TAZ P/N TO ORDER

### Part Number Designations

<b>^ = Termination Finish:<sup>1</sup></b> For TAZ p/n: 9 = Gold Plated 8 = Hot Solder Dipped 0 = Solder Fused For CWR p/n: B = Gold Plated C = Hot Solder Dipped K = Solder Fused	<b># = Inspection Level:</b> S = Std. Conformance L = Group A For CWR p/n: M = Military Conformance per MIL-PRF-55365	<b>* = Tolerance:</b> M = $\pm$ 20% K = $\pm$ 10% J = $\pm$ 5% (Special order only)	<b>@ = Failure Rate Level:</b> Weibull: B = 0.01%/1000 Hrs. (90% C = 0.01%/1000 Hrs. conf.) Comm: Z = Non ER	<b>+ = Surge Option:</b> For TAZ p/n: 00 = None 23 = 10 cycles, +25°C 24 = 10 cycles, -55°C & +85°C 45 = 10 cycles, -55°C & +85°C before Weibull For CWR p/n: A = 10 cycles, +25°C B = 10 cycles, -55°C & +85°C C = 10 cycles, -55°C & +85°C before Weibull Z = None (required for CWR19 & CWR29 only)	<b>□ = Packaging:</b> For TAZ p/n: B = Bulk R = 7" T&R S = 13" T&R For CWR p/n: Bulk = Standard VTR = 7" T&R VTR13 = 13" T&R W = Waffle
--	--	--	--	--	--



# Surface Mount Military



## CWR29

### CWR29 - MIL-PRF-55365/11

A low ESR version of CWR09 and CWR19 that is fully qualified to MIL-PRF-55365/11, this series represents the most flexible of surface mount form factors, offering nine case sizes. The molded construction is compatible with a wide range of SMT board assembly processes including wave or reflow solder, conductive epoxy or compression bonding techniques. The five smaller cases are characterized by their

low profile construction; with the A case being the world's smallest molded military tantalum. There are three termination finishes available: fused solder plated ("K" per MIL-PRF-55365), hot solder dipped ("C") and gold plated ("B"). In addition, the molding compound has been selected to meet the requirements of UL94V-0 (Flame Retardancy) and requirements of NASA SP-R-0022A (Outgassing).

### PART NUMBERING SYSTEM

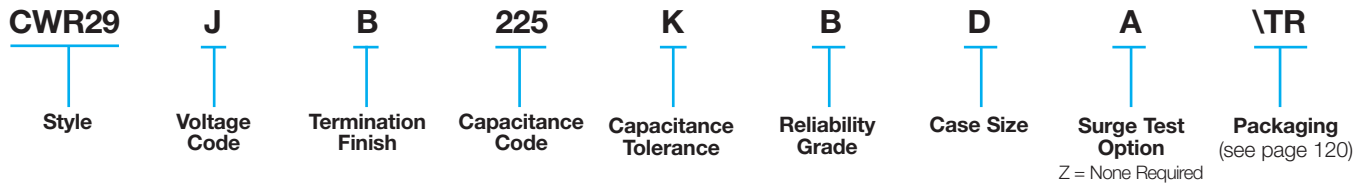

### LOW ESR RANGE - TAZ PROFESSIONAL AND CWR29 MILITARY (MIL PRF-55365/11)

Capacitance and Voltage Range (letter denotes case size)									
Capacitance		Rated voltage DC (V <sub>R</sub> ) at 85°C							
μF	Code	4V(C)	6.3V(D)	10V(F)	15V(H)	20V(J)	25V(K)	35V(M)	50V(N)
0.10	104								A
0.15	154								A
0.22	224							A	B
0.33	334						A	A	B
0.47	474				A	A	A	B	C
0.68	684				A	A/B	B	C	D
1.0	105			A	A	A/B	B/C	D	E
1.5	155		A	A/B	A/B	B/C	D	E	F
2.2	225	A		A/B	A/C	B/D	D/E		F
3.3	335	A	A/B	A/C	B/D	D/E	E	F	G
4.7	475	A/B	A/C	B/C/D	B/C/D/E	E	F	G	H
6.8	685	A/C	B/D	B/C/D/E	D/E	E/F	F/G	G/H	
10	106	B/D	B/E	B/C/D/E	D/E/F	E/F	G	H	
15	156	B/E	B/D/E	D/E/F	E/F	F/G	G/H	X	
22	226	B/D	D/E/F	E	F/G	G/H	G/H/X		
33	336	D/E/F	E	F/G	F/G/H	H	H/X		
47	476	E	F/G	F/G/H	G/H	H/X			
68	686	E/G	F/G/H	G	G/H				
100	107	F/H	G	G/H	H				
150	157	G	G	H/X					
220	227	G	H	H					
330	337	H	H						



# Surface Mount Military

## CWR29 - MIL-PRF-55365/11 and TAZ COTS-Plus



AVX Part Number	QPL Part Number	DC rated voltage (85°C) (volts)	Cap (nom) μF	DC Leakage (max)			Dissipation Factor (max)			ESR (max) 100 kHz +25°C (Ohms)	Case Size
				+25°C (μA)	+85°C (μA)	+125°C (μA)	+25°C (%)	+85/125°C (%)	-55°C (%)		
TAZA225*004L#@0^++	CWR29C-225*@A+□	4	2.2	1	10	12	6	8	8	4	A
TAZA335*004L#@0^++	CWR29C-335*@A+□	4	3.3	1	10	12	6	8	8	6	A
TAZA475*004L#@0^++	CWR29C-475*@A+□	4	4.7	1	10	12	6	8	8	6	A
TAZB475*004L#@0^++	CWR29C-475*@B+□	4	4.7	1	10	12	6	8	8	3.2	B
TAZA685*004L#@0^++	CWR29C-685*@A+□	4	6.8	1	10	12	6	8	8	6	A
TAZC685*004L#@0^++	CWR29C-685*@C+□	4	6.8	1	10	12	6	8	8	2.2	C
TAZB106*004L#@0^++	CWR29C-106*@B+□	4	10	1	10	12	8	10	10	3.2	B
TAZD106*004L#@0^++	CWR29C-106*@D+□	4	10	1	10	12	8	8	10	1.3	D
TAZB156*004L#@0^++	CWR29C-156*@B+□	4	15	1	10	12	8	10	10	3.2	B
TAZE156*004L#@0^++	CWR29C-156*@E+□	4	15	1	10	12	8	10	12	1	E
TAZB226*004L#@0^++	CWR29C-226*@B+□	4	22	1	10	12	8	10	10	3.2	B
TAZD226*004L#@0^++	CWR29C-226*@D+□	4	22	1	10	12	8	10	12	1.3	D
TAZD336*004L#@0^++	CWR29C-336*@D+□	4	33	2	20	24	8	10	12	1.3	D
TAZE336*004L#@0^++	CWR29C-336*@E+□	4	33	2	20	24	8	10	12	0.9	E
TAZF336*004L#@0^++	CWR29C-336*@F+□	4	33	2	20	24	8	10	12	0.6	F
TAZE476*004L#@0^++	CWR29C-476*@E+□	4	47	2	20	24	8	10	12	0.9	E
TAZE686*004L#@0^++	CWR29C-686*@E+□	4	68	3	30	36	8	10	12	0.9	E
TAZG686*004L#@0^++	CWR29C-686*@G+□	4	68	3	30	36	10	12	12	0.275	G
TAZF107*004L#@0^++	CWR29C-107*@F+□	4	100	4	40	48	10	12	12	0.55	F
TAZH107*004L#@0^++	CWR29C-107*@H+□	4	100	4	40	48	10	12	12	0.18	H
TAZG157*004L#@0^++	CWR29C-157*@G+□	4	150	6	60	72	10	12	12	0.25	G
TAZG227*004L#@0^++	CWR29C-227*@G+□	4	220	8	80	96	10	12	12	0.2	G
TAZH337*004L#@0^++	CWR29C-337*@H+□	4	330	10	100	120	10	12	12	0.18	
TAZA155*006L#@0^++	CWR29D-155*@A+□	6	1.5	1	10	12	6	8	8	4	A
TAZA335*006L#@0^++	CWR29D-335*@A+□	6	3.3	1	10	12	6	8	8	6	A
TAZB335*006L#@0^++	CWR29D-335*@B+□	6	3.3	1	10	12	6	8	8	3.2	B
TAZA475*006L#@0^++	CWR29D-475*@A+□	6	4.7	1	10	12	6	8	8	6	A
TAZC475*006L#@0^++	CWR29D-475*@C+□	6	4.7	1	10	12	6	8	8	2.2	C
TAZB685*006L#@0^++	CWR29D-685*@B+□	6	6.8	1	10	12	6	8	8	3.2	B
TAZD685*006L#@0^++	CWR29D-685*@D+□	6	6.8	1	10	12	6	8	8	1.5	D
TAZB106*006L#@0^++	CWR29D-106*@B+□	6	10	1	10	12	6	8	8	3.2	B
TAZE106*006L#@0^++	CWR29D-106*@E+□	6	10	1	10	12	8	10	12	1	E
TAZB156*006L#@0^++	CWR29D-156*@B+□	6	15	1	10	12	8	10	10	3.2	B
TAZD156*006L#@0^++	CWR29D-156*@D+□	6	15	1	10	12	8	10	12	1.7	D
TAZE156*006L#@0^++	CWR29D-156*@E+□	6	15	1	10	12	8	10	12	0.9	E
TAZD226*006L#@0^++	CWR29D-226*@D+□	6	22	1	10	12	6	8	8	1.7	D
TAZE226*006L#@0^++	CWR29D-226*@E+□	6	22	2	20	24	8	10	12	1	E
TAZF226*006L#@0^++	CWR29D-226*@F+□	6	22	2	20	24	8	10	12	0.6	F
TAZE336*006L#@0^++	CWR29D-336*@E+□	6	33	2	20	24	6	8	8	1	E
TAZF476*006L#@0^++	CWR29D-476*@F+□	6	47	3	30	36	8	10	12	1	F
TAZG476*006L#@0^++	CWR29D-476*@G+□	6	47	3	30	36	10	12	12	0.275	G
TAZF686*006L#@0^++	CWR29D-686*@F+□	6	68	4	40	48	10	12	12	0.4	F
TAZG686*006L#@0^++	CWR29D-686*@G+□	6	68	4	40	48	10	12	12	0.25	G

Following the voltage code, C designates Standard, L designates Low ESR Ratings  
 CWR19, CWR29 DESIGNATIONS ARE INCLUDED FOR REFERENCE ONLY – USE TAZ P/N TO ORDER

### Part Number Designations

- ^ = Termination Finish:**<sup>1</sup>
- For TAZ p/n:** 9 = Gold Plated, 8 = Hot Solder Dipped, 0 = Solder Fused
- For CWR p/n:** B = Gold Plated, C = Hot Solder Dipped, K = Solder Fused
- # = Inspection Level:** S = Std. Conformance, L = Group A
- For CWR p/n:** M = Military, Conformance per MIL-PRF-55365
- \* = Tolerance:** M = ±20%, K = ±10%, J = ±5% (Special order only)
- @ = Failure Rate Level:** Weibull: B = 0.1%/1000 Hrs. (90% C = 0.01%/1000 Hrs. conf.), Comm: Z = Non ER
- + = Surge Option:** For TAZ p/n: 00 = None, 23 = 10 cycles, +25°C, 24 = 10 cycles, -55°C & +85°C, 45 = 10 cycles, -55°C & +85°C before Weibull
- For CWR p/n:** A = 10 cycles, +25°C, B = 10 cycles, -55°C & +85°C, C = 10 cycles, -55°C & +85°C before Weibull, Z = None (required for CWR19 & CWR29 only)
- = Packaging:** For TAZ p/n: B = Bulk, R = 7" T&R, S = 13" T&R
- For CWR p/n:** Bulk = Standard, \TR = 7" T&R, \TR13 = 13" T&R, \W = Waffle



# Surface Mount Military



## CWR29 - MIL-PRF-55365/11 and TAZ COTS-Plus

AVX Part Number	QPL Part Number	DC rated voltage (85°C) (volts)	Cap (nom) μF	DC Leakage (max)			Dissipation Factor (max)			ESR (max) 100 kHz +25°C (Ohms)	Case Size
				+25°C (μA)	+85°C (μA)	+125°C (μA)	+25°C (%)	+85/125°C (%)	-55°C (%)		
TAZH686*006L#@0^++	CWR29D-686*@H+□	6	68	4	40	48	10	12	12	0.18	H
TAZG107*006L#@0^++	CWR29D-107*@G+□	6	100	6	60	72	10	12	12	0.275	G
TAZG157*006L#@0^++	CWR29D-157*@G+□	6	150	10	100	120	10	12	12	0.275	G
TAZH227*006L#@0^++	CWR29D-227*@H+□	6	220	10	100	120	10	12	12	0.18	H
TAZH337*006L#@0^++	CWR29D-337*@H+□	6	330	20	200	240	10	12	12	0.18	H
TAZA105*010L#@0^++	CWR29F-105*@A+□	10	1	1	10	12	6	8	8	5	A
TAZA225*010L#@0^++	CWR29F-225*@A+□	10	2.2	1	10	12	6	8	8	6	A
TAZB225*010L#@0^++	CWR29F-225*@B+□	10	2.2	1	10	12	6	8	8	3.2	B
TAZA335*010L#@0^++	CWR29F-335*@A+□	10	3.3	1	10	12	6	8	8	6	A
TAZC335*010L#@0^++	CWR29F-335*@C+□	10	3.3	1	10	12	6	8	8	2.2	C
TAZB475*010L#@0^++	CWR29F-475*@B+□	10	4.7	1	10	12	6	8	8	3.2	B
TAZC475*010L#@0^++	CWR29F-475*@C+□	10	4.7	1	10	12	6	8	8	2.2	C
TAZD475*010L#@0^++	CWR29F-475*@D+□	10	4.7	1	10	12	6	8	8	1.5	D
TAZB685*010L#@0^++	CWR29F-685*@B+□	10	6.8	1	10	12	6	8	8	3.2	B
TAZC685*010L#@0^++	CWR29F-685*@C+□	10	6.8	1	10	12	6	8	8	2.2	C
TAZD685*010L#@0^++	CWR29F-685*@D+□	10	6.8	1	10	12	6	8	8	1.7	D
TAZE685*010L#@0^++	CWR29F-685*@E+□	10	6.8	1	10	12	6	8	8	1	E
TAZB106*010L#@0^++	CWR29F-106*@B+□	10	10	1	10	12	8	10	10	3.2	B
TAZC106*010L#@0^++	CWR29F-106*@C+□	10	10	1	10	12	6	8	8	2.2	C
TAZD106*010L#@0^++	CWR29F-106*@D+□	10	10	1	10	12	6	8	8	1.3	D
TAZE106*010L#@0^++	CWR29F-106*@E+□	10	10	1	10	12	6	8	8	1	E
TAZ156*010L#@0^++	CWR29F-156*@D+□	10	15	2	20	24	6	8	8	1.7	D
TAZE156*010L#@0^++	CWR29F-156*@E+□	10	15	2	20	24	8	10	10	0.9	E
TAZF156*010L#@0^++	CWR29F-156*@F+□	10	15	2	20	24	8	8	10	0.7	F
TAZE226*010L#@0^++	CWR29F-226*@E+□	10	22	3	30	36	8	10	10	0.6	E
TAZF336*010L#@0^++	CWR29F-336*@F+□	10	33	3	30	36	8	10	10	0.4	F
TAZG336*010L#@0^++	CWR29F-336*@G+□	10	33	3	30	36	10	12	12	0.275	G
TAZF476*010L#@0^++	CWR29F-476*@F+□	10	47	4	40	48	10	12	12	0.4	F
TAZG476*010L#@0^++	CWR29F-476*@G+□	10	47	4	40	48	10	12	12	0.25	G
TAZH476*010L#@0^++	CWR29F-476*@H+□	10	47	5	50	60	10	12	12	0.18	H
TAZG686*010L#@0^++	CWR29F-686*@G+□	10	68	6	60	72	10	12	12	0.275	G
TAZG107*010L#@0^++	CWR29F-107*@G+□	10	100	10	100	120	10	12	12	0.275	G
TAZH107*010L#@0^++	CWR29F-107*@H+□	10	100	10	100	120	10	12	12	0.18	H
TAZH157*010L#@0^++	CWR29F-157*@H+□	10	150	15	150	180	10	12	12	0.18	H
TAZX157*010L#@0^++	CWR29F-157*@X+□	10	150	15	150	180	10	12	12	0.065	X
TAZH227*010L#@0^++	CWR29F-227*@H+□	10	220	20	200	240	10	12	12	0.18	H
TAZA684*015L#@0^++	CWR29H^684*@A+□	15	0.68	1	10	12	6	8	8	6	A
TAZA105*015L#@0^++	CWR29H^105*@A+□	15	1	1	10	12	6	8	8	7.5	A
TAZA155*015L#@0^++	CWR29H^155*@A+□	15	1.5	1	10	12	6	8	8	7.5	A
TAZB155*015L#@0^++	CWR29H^155*@B+□	15	1.5	1	10	12	6	8	8	3.2	B
TAZA225*015L#@0^++	CWR29H^225*@A+□	15	2.2	1	10	12	6	8	8	7.5	A
TAZC225*015L#@0^++	CWR29H^225*@C+□	15	2.2	1	10	12	6	8	8	2.2	C
TAZB335*015L#@0^++	CWR29H^335*@B+□	15	3.3	1	10	12	6	8	8	3.6	B
TAZD335*015L#@0^++	CWR29H^335*@D+□	15	3.3	1	10	12	6	8	8	1.7	D

Following the voltage code, C designates Standard, L designates Low ESR Ratings  
 CWR19, CWR29 DESIGNATIONS ARE INCLUDED FOR REFERENCE ONLY – USE TAZ P/N TO ORDER

### Part Number Designations

- ^ = Termination Finish:**<sup>1</sup>  
**For TAZ p/n:**  
 9 = Gold Plated  
 8 = Hot Solder Dipped  
 0 = Solder Fused  
**For CWR p/n:**  
 B = Gold Plated  
 C = Hot Solder Dipped  
 K = Solder Fused
- # = Inspection Level:**  
 S = Std. Conformance  
 L = Group A  
**For CWR p/n:**  
 M = Military  
 Conformance per MIL-PRF-55365
- \* = Tolerance:**  
 M = ±20%  
 K = ±10%  
 J = ±5% (Special order only)
- @ = Failure Rate Level:**  
 Weibull: B = 0.1%/1000 Hrs. (90% C = 0.01%/1000 Hrs. conf.)  
 Comm: Z = Non ER
- + = Surge Option:**  
**For TAZ p/n:**  
 00 = None  
 23 = 10 cycles, +25°C  
 24 = 10 cycles, -55°C & +85°C  
 45 = 10 cycles, -55°C & +85°C before Weibull  
**For CWR p/n:**  
 A = 10 cycles, +25°C  
 B = 10 cycles, -55°C & +85°C  
 C = 10 cycles, -55°C & +85°C before Weibull  
 Z = None (required for CWR19 & CWR29 only)
- = Packaging:**  
**For TAZ p/n:**  
 B = Bulk  
 R = 7" T&R  
 S = 13" T&R  
**For CWR p/n:**  
 Bulk = Standard  
 \TR = 7" T&R  
 \TR13 = 13" T&R  
 \W = Waffle



# Surface Mount Military



## CWR29 - MIL-PRF-55365/11 and TAZ COTS-Plus

AVX Part Number	QPL Part Number	DC rated voltage (85°C) (volts)	Cap (nom) µF	DC Leakage (max)			Dissipation Factor (max)			ESR (max) 100 kHz +25°C (Ohms)	Case Size
				+25°C (µA)	+85°C (µA)	+125°C (µA)	+25°C (%)	+85/125°C (%)	-55°C (%)		
TAZB475*015L#@0^++	CWR29H-475*@B+□	15	4.7	1	10	12	6	8	8	2	B
TAZC475*015L#@0^++	CWR29H-475*@C+□	15	4.7	1	10	12	6	8	8	2.2	C
TAZD475*015L#@0^++	CWR29H-475*@D+□	15	4.7	1	10	12	6	8	8	2	D
TAZE475*015L#@0^++	CWR29H-475*@E+□	15	4.7	1	10	12	6	8	8	1.2	E
TAZD685*015L#@0^++	CWR29H-685*@D+□	15	6.8	1	10	12	6	8	8	2	D
TAZE685*015L#@0^++	CWR29H-685*@E+□	15	6.8	1	10	12	8	10	12	0.9	E
TAZD106*015L#@0^++	CWR29H-106*@D+□	15	10	2	20	24	6	8	8	2	D
TAZE106*015L#@0^++	CWR29H-106*@E+□	15	10	2	20	24	6	8	8	1.2	E
TAZF106*015L#@0^++	CWR29H-106*@F+□	15	10	2	20	24	6	8	8	0.667	F
TAZE156*015L#@0^++	CWR29H-156*@E+□	15	15	2	20	24	6	8	8	1.2	E
TAZF156*015L#@0^++	CWR29H-156*@F+□	15	15	2	20	24	8	10	10	0.8	F
TAZF226*015L#@0^++	CWR29H-226*@F+□	15	22	3	30	36	8	10	10	0.8	F
TAZG226*015L#@0^++	CWR29H-226*@G+□	15	22	4	40	48	6	8	8	0.275	G
TAZF336*015L#@0^++	CWR29H-336*@F+□	15	33	5	50	60	6	8	8	0.8	F
TAZG336*015L#@0^++	CWR29H-336*@G+□	15	33	6	60	72	8	10	10	0.275	G
TAZH336*015L#@0^++	CWR29H-336*@H+□	15	33	5	50	60	8	8	10	0.18	H
TAZG476*015L#@0^++	CWR29H-476*@G+□	15	47	10	100	120	8	10	10	0.275	G
TAZH476*015L#@0^++	CWR29H-476*@H+□	15	47	10	100	120	8	10	10	0.18	H
TAZG686*015L#@0^++	CWR29H-686*@G+□	15	68	10	100	120	8	10	10	0.275	G
TAZH686*015L#@0^++	CWR29H-686*@H+□	15	68	10	100	120	8	10	10	0.18	H
TAZH107*015L#@0^++	CWR29H-107*@H+□	15	100	15	150	180	10	12	12	0.18	H
TAZA474*020L#@0^++	CWR29J-474*@A+□	20	0.47	1	10	12	8	8	10	7.5	A
TAZA684*020L#@0^++	CWR29J-684*@A+□	20	0.68	1	10	12	6	8	8	7.5	A
TAZB684*020L#@0^++	CWR29J-684*@B+□	20	0.68	1	10	12	6	8	8	5.6	B
TAZA105*020L#@0^++	CWR29J-105*@A+□	20	1	1	10	12	6	8	8	7.5	A
TAZB105*020L#@0^++	CWR29J-105*@B+□	20	1	1	10	12	6	8	8	4.8	B
TAZB155*020L#@0^++	CWR29J-155*@B+□	20	1.5	1	10	12	6	8	8	3.6	B
TAZC155*020L#@0^++	CWR29J-155*@C+□	20	1.5	1	10	12	6	8	8	2.4	C
TAZB225*020L#@0^++	CWR29J-225*@B+□	20	2.2	1	10	12	6	8	8	3.6	B
TAZD226*020L#@0^++	CWR29J-225*@D+□	20	2.2	1	10	12	6	8	8	1.7	D
TAZD335*020L#@0^++	CWR29J-335*@D+□	20	3.3	1	10	12	6	8	8	2	D
TAZE335*020L#@0^++	CWR29J-335*@E+□	20	3.3	1	10	12	6	8	8	1.2	E
TAZE475*020L#@0^++	CWR29J-475*@E+□	20	4.7	1	10	12	6	8	8	1.7	E
TAZE685*020L#@0^++	CWR29J-685*@E+□	20	6.8	2	20	24	6	8	8	1.5	E
TAZF685*020L#@0^++	CWR29J-685*@F+□	20	6.8	2	20	24	6	8	8	0.7	F
TAZE106*020L#@0^++	CWR29J-106*@E+□	20	10	2	20	24	6	8	8	1.5	E
TAZF106*020L#@0^++	CWR29J-106*@F+□	20	10	2	20	24	6	8	8	0.8	F
TAZF156*020L#@0^++	CWR29J-156*@F+□	20	15	3	30	36	6	8	8	0.8	F
TAZG156*020L#@0^++	CWR29J-156*@G+□	20	15	3	30	36	6	8	8	0.275	G
TAZG226*020L#@0^++	CWR29J-226*@G+□	20	22	4	40	48	6	8	8	0.625	G
TAZH226*020L#@0^++	CWR29J-226*@H+□	20	22	4	40	48	6	8	8	0.18	H
TAZH336*020L#@0^++	CWR29J-336*@H+□	20	33	6	60	72	8	10	10	0.18	H
TAZH476*020L#@0^++	CWR29J-476*@H+□	20	47	10	100	120	8	10	10	0.18	H
TAZX476*020L#@0^++	CWR29J-476*@X+□	20	47	10	100	120	8	10	10	0.11	X

Following the voltage code, C designates Standard, L designates Low ESR Ratings

CWR19, CWR29 DESIGNATIONS ARE INCLUDED FOR REFERENCE ONLY – USE TAZ P/N TO ORDER

### Part Number Designations

**^ = Termination Finish:**<sup>1</sup>

**For TAZ p/n:**

- 9 = Gold Plated
- 8 = Hot Solder Dipped
- 0 = Solder Fused

**For CWR p/n:**

- B = Gold Plated
- C = Hot Solder Dipped
- K = Solder Fused

**# = Inspection Level:**

- S = Std. Conformance
- L = Group A
- For CWR p/n:**
- M = Military

Conformance per MIL-PRF-55365

**\* = Tolerance:**

- M = ±20%
- K = ±10%
- J = ±5% (Special order only)

**@ = Failure Rate Level:**

- Weibull: B = 0.1%/1000 Hrs. (90% C = 0.01%/1000 Hrs. conf.)
- Comm: Z = Non ER

**+ = Surge Option:**

- For TAZ p/n:**
- 00 = None
- 23 = 10 cycles, +25°C
- 24 = 10 cycles, -55°C & +85°C
- 45 = 10 cycles, -55°C & +85°C before Weibull
- For CWR p/n:**
- A = 10 cycles, +25°C
- B = 10 cycles, -55°C & +85°C
- C = 10 cycles, -55°C & +85°C before Weibull
- Z = None (required for CWR19 & CWR29 only)

**□ = Packaging:**

- For TAZ p/n:**
- B = Bulk
- R = 7" T&R
- S = 13" T&R
- For CWR p/n:**
- Bulk = Standard
- \TR = 7" T&R
- \TR13 = 13" T&R
- W = Waffle





# Surface Mount Military



## CWR29 - MIL-PRF-55365/11 and TAZ COTS-Plus

AVX Part Number	QPL Part Number	DC rated voltage (85°C) (volts)	Cap (nom) µF	DC Leakage (max)			Dissipation Factor (max)			ESR (max) 100 kHz +25°C (Ohms)	Case Size
				+25°C (µA)	+85°C (µA)	+125°C (µA)	+25°C (%)	+85/125°C (%)	-55°C (%)		
TAZA334*025L#@0^++	CWR29K-334*@A+□	25	0.33	1	10	12	6	8	8	7.5	A
TAZA474*025L#@0^++	CWR29K-474*@A+□	25	0.47	1	10	12	6	8	8	7.5	A
TAZB684*025L#@0^++	CWR29K-684*@B+□	25	0.68	1	10	12	6	8	8	4	B
TAZB105*025L#@0^++	CWR29K-105*@B+□	25	1	1	10	12	6	8	8	4	B
TAZC105*025L#@0^++	CWR29K-105*@C+□	25	1	1	10	12	6	8	8	2.6	C
TAZD155*025L#@0^++	CWR29K-155*@D+□	25	1.5	1	10	12	6	8	8	1.7	D
TAZD225*025L#@0^++	CWR29K-225*@D+□	25	2.2	1	10	12	6	8	8	2	D
TAZE225*025L#@0^++	CWR29K-225*@E+□	25	2.2	1	10	12	6	8	8	1	E
TAZE335*025L#@0^++	CWR29K-335*@E+□	25	3.3	1	10	12	6	8	8	1.2	E
TAZF475*025L#@0^++	CWR29K-475*@F+□	25	4.7	2	20	24	6	8	8	0.7	F
TAZF685*025L#@0^++	CWR29K-685*@F+□	25	6.8	2	20	24	6	8	8	0.8	F
TAZG685*025L#@0^++	CWR29K-685*@G+□	25	6.8	2	20	24	6	8	8	0.3	G
TAZG106*025L#@0^++	CWR29K-106*@G+□	25	10	3	30	36	6	8	8	0.35	G
TAZG156*025L#@0^++	CWR29K-156*@G+□	25	15	4	40	48	6	8	8	0.35	G
TAZH156*025L#@0^++	CWR29K-156*@H+□	25	15	4	40	48	6	8	8	0.2	H
TAZG226*025L#@0^++	CWR29K-226*@G+□	25	22	6	60	72	6	8	8	0.35	G
TAZH226*025L#@0^++	CWR29K-226*@H+□	25	22	6	60	72	6	8	8	0.18	H
TAZX226*025L#@0^++	CWR29K-226*@X+□	25	22	6	60	72	6	8	8	0.16	X
TAZH336*025L#@0^++	CWR29K-336*@H+□	25	33	10	100	120	6	8	8	0.18	H
TAZX336*025L#@0^++	CWR29K-336*@X+□	25	33	10	100	120	8	10	10	0.13	X
TAZA224*035L#@0^++	CWR29M-224*@A+□	35	0.22	1	10	12	6	8	8	12	A
TAZA334*035L#@0^++	CWR29M-334*@A+□	35	0.33	1	10	12	6	8	8	12	A
TAZB474*035L#@0^++	CWR29M-474*@B+□	35	0.47	1	10	12	6	8	8	6.8	B
TAZC684*035L#@0^++	CWR29M-684*@C+□	35	0.68	1	10	12	6	8	8	4	C
TAZD105*035L#@0^++	CWR29M-105*@D+□	35	1	1	10	12	6	8	8	2.2	D
TAZE155*035L#@0^++	CWR29M-155*@E+□	35	1.5	1	10	12	6	8	8	1.3	E
TAZF335*035L#@0^++	CWR29M-335*@F+□	35	3.3	1	10	12	6	8	8	0.7	F
TAZG475*035L#@0^++	CWR29M-475*@G+□	35	4.7	2	20	24	6	8	8	0.375	G
TAZG685*035L#@0^++	CWR29M-685*@G+□	35	6.8	3	30	36	6	8	8	0.375	G
TAZH685*035L#@0^++	CWR29M-685*@H+□	35	6.8	3	30	36	6	8	8	0.5	H
TAZH106*035L#@0^++	CWR29M-106*@H+□	35	10	4	40	48	8	10	10	0.5	H
TAZX156*035L#@0^++	CWR29M-156*@X+□	35	15	6	60	72	6	8	8	0.19	X
TAZA104*050L#@0^++	CWR29N-104*@A+□	50	0.1	1	10	12	6	8	8	12	A
TAZA154*050L#@0^++	CWR29N-154*@A+□	50	0.15	1	10	12	6	8	8	12	A
TAZB224*050L#@0^++	CWR29N-224*@B+□	50	0.22	1	10	12	6	8	8	6.8	B
TAZB334*050L#@0^++	CWR29N-334*@B+□	50	0.33	1	10	12	6	8	8	4.8	B
TAZC474*050L#@0^++	CWR29N-474*@C+□	50	0.47	1	10	12	6	8	8	3.2	C
TAZD684*050L#@0^++	CWR29N-684*@D+□	50	0.68	1	10	12	6	8	8	2.3	D
TAZE105*050L#@0^++	CWR29N-105*@E+□	50	1	1	10	12	6	8	8	1.7	E
TAZF155*050L#@0^++	CWR29N-155*@F+□	50	1.5	1	10	12	6	8	8	1.1	F
TAZF225*050L#@0^++	CWR29N-225*@F+□	50	2.2	2	20	24	6	8	8	0.7	F
TAZG335*050L#@0^++	CWR29N-335*@G+□	50	3.3	2	20	24	6	8	8	0.5	G
TAZH475*050L#@0^++	CWR29N-475*@H+□	50	4.7	3	30	36	6	8	8	0.5	H

Following the voltage code, C designates Standard, L designates Low ESR Ratings

CWR19, CWR29 DESIGNATIONS ARE INCLUDED FOR REFERENCE ONLY – USE TAZ P/N TO ORDER

### Part Number Designations

^ = Termination Finish:¹

For TAZ p/n:

- 9 = Gold Plated
- 8 = Hot Solder Dipped
- 0 = Solder Fused

For CWR p/n:

- B = Gold Plated
- C = Hot Solder Dipped
- K = Solder Fused

# = Inspection Level:

- S = Std. Conformance
- L = Group A

For CWR p/n:

- M = Military Conformance per MIL-PRF-55365

\* = Tolerance:

- M = ±20%
- K = ±10%
- J = ±5% (Special order only)

@ = Failure Rate Level:

- Weibull: B = 0.1%/1000 Hrs. (90% C = 0.01%/1000 Hrs. conf.)
- Comm: Z = Non ER

+ = Surge Option:

- For TAZ p/n:
- 00 = None
- 23 = 10 cycles, +25°C
- 24 = 10 cycles, -55°C & +85°C
- 45 = 10 cycles, -55°C & +85°C before Weibull

For CWR p/n:

- A = 10 cycles, +25°C
- B = 10 cycles, -55°C & +85°C
- C = 10 cycles, -55°C & +85°C before Weibull
- Z = None (required for CWR19 & CWR29 only)

□ = Packaging:

For TAZ p/n:

- B = Bulk
- R = 7" T&R
- S = 13" T&R

For CWR p/n:

- Bulk = Standard
- \TR = 7" T&R
- \TR13 = 13" T&R
- \W = Waffle



### TAZ COTS-Plus SERIES (CWR09)

This series features:

- CWR09 form factor in Standard and Extended ratings.
- Weibull Reliability Grading and Surge Test options.

All ratings in this series offer the advantages of molded body/compliant termination construction, polarity, capacitance and voltage marking. The molded construction is compatible with a wide range of SMT board assembly processes including wave or reflow solder, conductive epoxy or compression bonding techniques.

#### PART NUMBERING SYSTEM

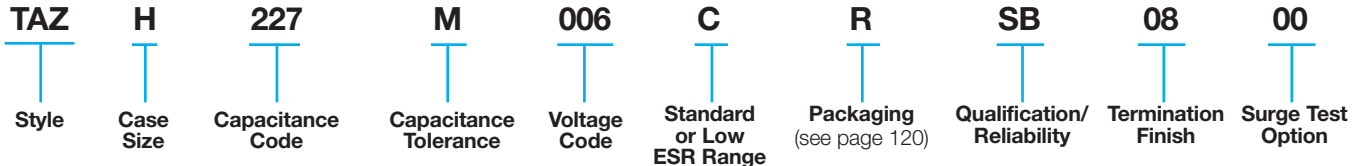

### TAZ COTS-Plus EXTENDED RANGE SERIES (CWR19)

This series features:

- CWR19 form factor in Extended ratings
- Low Profile molded design (Cases A through E)
- Extended case size (X) for ratings to 330 $\mu$ F
- Weibull Reliability Grading and Surge Test Options
- Ratings / Electrical Limits not listed in catalog may be available (Contact AVX)

#### PART NUMBERING SYSTEM

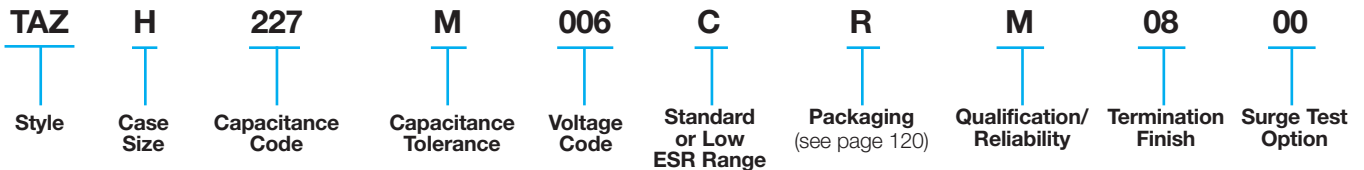

### TAZ COTS-Plus LOW ESR SERIES (CWR29)

This series features:

- CWR29 form factor in Low ESR and Extended ratings
- Low Profile molded design (Cases A through E)
- Low ESR Ratings (Cases A through H and X)
- Extended case size (X) for ratings to 330 $\mu$ F
- Weibull Reliability Grading and Surge Test Options
- Ratings / Electrical Limits not listed in catalog may be available (Contact AVX)

#### PART NUMBERING SYSTEM

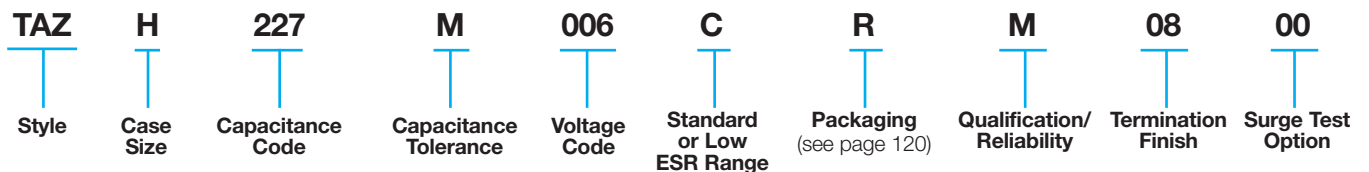

# TBJ Series



## Including CWR11 and COTS-Plus

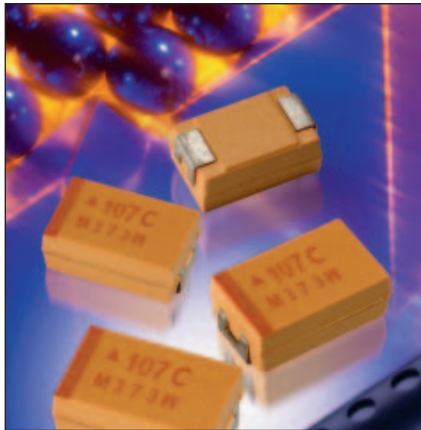

The TBJ Series encompasses five case sizes, A through E, corresponding to EIA-535BAAC, the commercial industry standard. This series also offers molded body/compliant construction, polarity and capacitance marking. The molded construction is compatible with a wide range of SMT board assembly processes including wave or reflow

solder, conductive epoxy or compression bonding techniques. Standard termination finish is fused solder. Gold termination is optional on CWR11 ratings. Case sizes A through D include QPL ratings available to the CWR11 military part number; other extended range and Low ESR ratings are available in all case sizes.

### CASE DIMENSIONS: millimeters (inches)

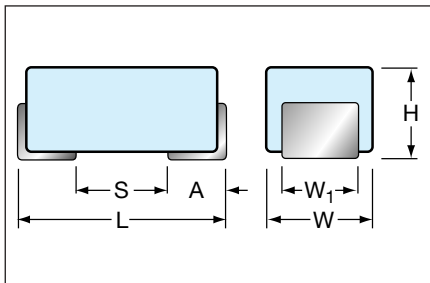

Case Code	EIA Code	Length (L)	Width (W)	Height (H)	Term. Width (W <sub>1</sub> ) ±0.10 (±0.004)	Term. Length A ±0.30(±0.012)	S min
A	3216-18	3.20±0.20 (0.126±0.008)	1.60±0.20 (0.063±0.008)	1.60±0.20 (0.063±0.008)	1.20 (0.047)	0.80 (0.031)	0.80 (0.031)
B	3528-21	3.50±0.20 (0.138±0.008)	2.80±0.20 (0.110±0.008)	1.90±0.20 (0.075±0.008)	2.20 (0.087)	0.80 (0.031)	1.10 (0.043)
C	6032-28	6.00±0.30 (0.236±0.012)	3.20±0.30 (0.126±0.012)	2.50±0.30 (0.098±0.012)	2.20 (0.087)	1.30 (0.051)	2.50 (0.098)
D	7343-31	7.30±0.30 (0.287±0.012)	4.30±0.30 (0.169±0.012)	2.80±0.30 (0.110±0.012)	2.40 (0.094)	1.30 (0.051)	3.80 (0.150)
E	7343-43	7.30±0.30 (0.287±0.012)	4.30±0.30 (0.169±0.012)	4.10±0.30 (0.162±0.012)	2.40 (0.094)	1.30 (0.051)	3.80 (0.150)
V		7.30±0.30 (0.287±0.012)	6.10±0.200 (0.240±0.008)	3.45±0.30 (0.136±0.012)	3.10 (0.120)	1.40+0.30/-0.20 (0.055+0.012/-0.008)	4.40 (0.173)

### MILITARY MARKING

(Brown marking on gold body)

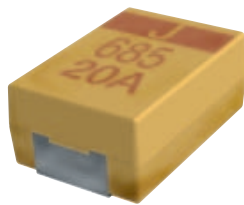

**Polarity Stripe (+)**  
**"J" for "JAN" Brand**  
**Capacitance Code**  
**Rated Voltage**  
**Manufacturer's ID**

### "COTS - Plus" MARKING

(Brown marking on gold body)

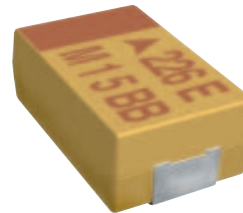

**Polarity Stripe (+)**  
**Capacitance Code**  
**Rated Voltage**  
**Manufacturer's ID**  
**Lot Number**

Technical Data:	Unless otherwise specified, all technical data relate to an ambient temperature of 25°C									
Capacitance Range:	0.1 to 470 µF									
Capacitance Tolerance:	±20%, ±10%, ±5%									
Rated DC Voltage: (V <sub>R</sub> )	≤85°C:	4	6	10	16	20	25	35	50	
Category Voltage: (V <sub>C</sub> )	125°C:	2.7	4	7	10	13	17	23	33	
Surge Voltage: (V <sub>C</sub> )	≤85°C:	5.2	8	13	20	26	33	46	65	
	125°C:	3.5	5	9	12	16	21	28	40	
Operating Temperature Range:	-55°C to +125°C									

## CWR11 - MIL-PRF-55365/8 and TBJ COTS-Plus

### CWR11 - MIL-PRF-55365/8

Fully qualified to MIL-PRF-55365/8, the CWR11 is the military version of EIA-535BAAC, the commercial industry standard. It comprises four case sizes (A through D). This series also offers molded body/compliant termination construction, polarity, capacitance and JAN brand marking. The molded construction is compatible with a wide range of

SMT board assembly processes including wave or reflow solder, conductive epoxy or compression bonding techniques. There are three termination finishes available: fused solder plated (“K” per MIL-PRF-55365), hot solder dipped (“C”) and gold plated (“B”).

### PART NUMBERING SYSTEM

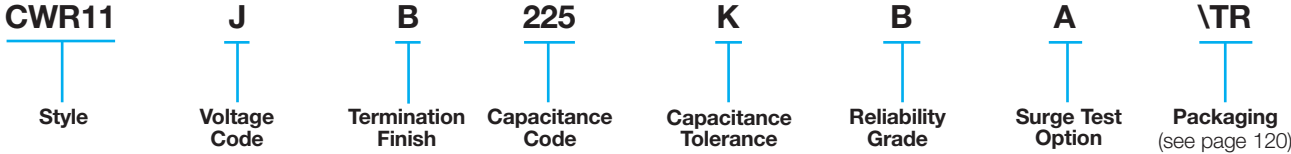

### TBJ COTS-Plus SERIES

This series features:

- CWR11 form factor in Standard and Extended ratings.
- Low ESR Ratings (Cases A through E).
- Extended Case size (E) for ratings to 470 µF.
- Weibull Reliability Grading and Surge Test options.

All ratings in this series offer the advantages of molded body/compliant termination construction, polarity, capacitance and voltage marking. The molded construction is compatible with a wide range of SMT board assembly processes including wave or reflow solder, conductive epoxy or compression bonding techniques.

### PART NUMBERING SYSTEM

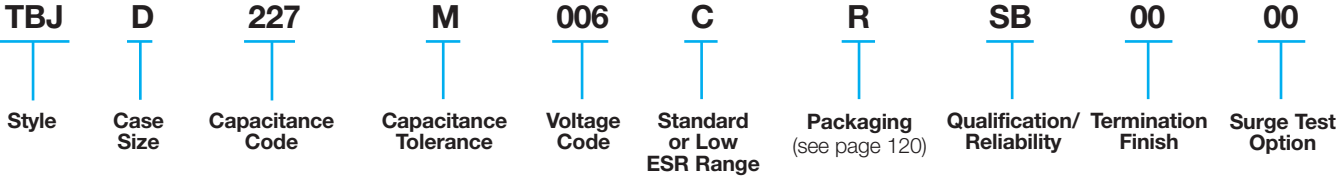

# Surface Mount Military



## CWR11 - MIL-PRF-55365/8 and TBJ COTS-Plus

AVX Part Number	QPL Part Number (for reference only)	DC rated voltage (85°C) (volts)	Cap (nom) µF	DC Leakage (max)			Dissipation Factor (max)			ESR (max) 100 kHz +25°C (Ohms)	Case Size
				+25°C (µA)	+85°C (µA)	+125°C (µA)	+25°C (%)	+85/125°C (%)	-55°C (%)		
TBJA225(*)004C□#@00++	CWR11CK225*@+□	4	2.2	0.5	5.0	6.0	6	9	9	8.0	A
TBJA475(*)004C□#@00++	CWR11CK475*@+□	4	4.7	0.5	5.0	6.0	6	9	9	8.0	A
TBJA685(*)004C□#@00++		4	6.8	0.5	5.0	10.0	6	9	10	6.5	A
TBJB685(*)004C□#@00++	CWR11CK685*@+□	4	6.8	0.5	5.0	6.0	6	9	9	5.5	B
TBJA106(*)004C□#@00++		4	10.0	0.5	5.0	10.0	6	9	10	6.0	A
TBJB106(*)004C□#@00++	CWR11CK106*@+□	4	10.0	0.5	5.0	6.0	6	9	9	4.0	B
TBJA156(*)004C□#@00++		4	15.0	0.6	6.0	12.0	6	9	10	4.0	A
TBJB156(*)004C□#@00++	CWR11CK156*@+□	4	15.0	0.6	6.0	7.2	6	9	9	3.5	B
TBJA226(*)004C□#@00++		4	22.0	0.9	9.0	18.0	6	9	10	3.5	A
TBJA336(*)004C□#@00++		4	33.0	1.4	14.0	28.0	6	9	9	3.0	A
TBJB336(*)004C□#@00++		4	33.0	1.4	14.0	28.0	6	9	10	2.8	B
TBJC336(*)004C□#@00++	CWR11CK336*@+□	4	33.0	1.3	13.0	15.6	6	9	9	2.2	C
TBJB476(*)004C□#@00++		4	47.0	1.9	19.0	38.0	6	9	10	2.4	B
TBJC686(*)004C□#@00++		4	68.0	2.7	27.0	54.0	6	9	10	1.6	C
TBJD686(*)004C□#@00++	CWR11CK686*@+□	4	68.0	2.7	27.0	32.4	6	9	9	1.1	D
TBJB107(*)004C□#@00++		4	100.0	4.0	40.0	80.0	8	10	12	1.6	B
TBJC107(*)004C□#@00++		4	100.0	4.0	40.0	80.0	6	9	10	1.3	C
TBJD107(*)004C□#@00++	CWR11CK107*@+□	4	100.0	4.0	40.0	48.0	8	12	12	0.9	D
TBJD227(*)004C□#@00++		4	220.0	8.8	88.0	176.0	8	10	12	0.9	D
TBJE337(*)004C□#@00++		4	330.0	13.2	132.0	264.0	8	10	12	0.9	E
TBJA155(*)006C□#@00++	CWR11DK155*@+□	6.3	1.5	0.5	5.0	6.0	6	9	9	8.0	A
TBJA225(*)006C□#@00++	CWR11DK225*@+□	6.3	2.2	0.5	5.0	6.0	6	6	9	8.0	A
TBJA335(*)006C□#@00++	CWR11DK335*@+□	6.3	3.3	0.5	5.0	6.0	6	9	9	8.0	A
TBJA475(*)006C□#@00++		6.3	4.7	0.5	5.0	10.0	6	9	10	6.0	A
TBJB475(*)006C□#@00++	CWR11DK475*@+□	6.3	4.7	0.5	5.0	6.0	6	9	9	5.5	B
TBJA685(*)006C□#@00++		6.3	6.8	0.5	5.0	10.0	6	9	10	5.0	A
TBJB685(*)006C□#@00++	CWR11DK685*@+□	6.3	6.8	0.5	5.0	6.0	6	9	9	4.5	B
TBJA106(*)006C□#@00++		6.3	10.0	1.0	10.0	20.0	6	9	10	4.0	A
TBJB106(*)006C□#@00++	CWR11DK106*@+□	6.3	10.0	0.6	6.0	7.2	6	9	9	3.5	B
TBJA156(*)006C□#@00++		6.3	15.0	1.0	10.0	20.0	6	9	10	3.5	A
TBJA156(*)006L□#@00++		6.3	15.0	1.0	10.0	20.0	6	9	10	1.5	A
TBJB156(*)006C□#@00++		6.3	15.0	1.0	10.0	20.0	6	9	10	3.5	B
TBJC156(*)006C□#@00++	CWR11DK156*@+□	6.3	15.0	0.9	9.0	10.8	6	9	9	3.0	C
TBJA226(*)006C□#@00++		6.3	22.0	1.4	14.0	28.0	6	9	10	3.0	A
TBJB226(*)006C□#@00++		6.3	22.0	1.4	14.0	28.0	6	9	10	2.5	B
TBJC226(*)006C□#@00++	CWR11DK226*@+□	6.3	22.0	1.4	14.0	16.8	6	9	9	2.2	C
TBJB336(*)006C□#@00++		6.3	33.0	2.1	21.0	42.0	6	9	10	2.2	B
TBJB336(*)006L□#@00++		6.3	33.0	2.1	21.0	42.0	6	9	10	0.600	B
TBJC336(*)006C□#@00++		6.3	33.0	2.1	21.0	42.0	6	9	10	1.8	C
TBJC476(*)006C□#@00++		6.3	47.0	3.0	30.0	60.0	6	9	10	1.6	C
TBJD476(*)006C□#@00++	CWR11DK476*@+□	6.3	47.0	2.8	28.0	33.6	6	9	9	1.1	D
TBJB686(*)006C□#@00++		6.3	68.0	4.3	43.0	86.0	8	10	12	1.8	B
TBJC686(*)006C□#@00++		6.3	68.0	4.3	43.0	86.0	6	9	10	1.6	C
TBJD686(*)006C□#@00++	CWR11DK686*@+□	6.3	68.0	4.3	43.0	86.0	6	9	9	0.9	D
TBJC107(*)006C□#@00++		6.3	100.0	6.3	63.0	126.0	6	9	10	0.9	C
TBJC107(*)006L□#@00++		6.3	100.0	6.3	63.0	126.0	6	9	10	0.150	C
TBJD107(*)006C□#@00++		6.3	100.0	6.3	63.0	126.0	6	9	10	0.9	D
TBJD157(*)006C□#@00++		6.3	150.0	9.5	95.0	190.0	6	9	10	0.9	D
TBJC227(*)006C□#@00++		6.3	220.0	13.9	139.0	278.0	10	12	14	1.2	C
TBJD227(*)006C□#@00++		6.3	220.0	13.9	139.0	278.0	8	10	12	0.9	D
TBJD227(*)006L□#@00++		6.3	220.0	13.9	139.0	278.0	8	10	12	0.100	D
TBJE337(*)006C□#@00++		6.3	330.0	19.8	198.0	396.0	8	10	12	0.9	E
TBJE337(*)006L□#@00++		6.3	330.0	20.8	208.0	416.0	8	10	12	0.100	E
TBJE477M006C□#@00++		6.3	470.0	29.6	296.0	592.0	10	12	14	0.9	E
TBJE477M006L□#@00++		6.3	470.0	29.6	296.0	592.0	10	12	14	0.050	E
TBJV477(*)006L□#@00++		6.3	470.0	29.6	296.0	592.0	10	12	12	0.100	V

Following the voltage code, C designates Standard, L Designates low ESR Ratings

### Part Number Designations

**\* = Tolerance:**

M = ±20%  
K = ±10%  
J = ±5% (Special order only)

**# = Inspection Level:**

S = Std. Conformance  
L = Group A  
**For CWR p/n:**  
M = Military Conformance per MIL-PRF-55365

**@ = Failure Rate Level:**

Weibull: B = 0.1%/1000 Hrs.  
(90% C = 0.01%/1000 Hrs. conf.)  
Comm: Z = Non ER

**+ = Surge Option:**

**For TBJ p/n:**  
00 = None  
23 = 10 cycles, +25°C  
24 = 10 cycles, -55°C & +85°C  
45 = 10 cycles, -55°C & +85°C before Weibull  
**For CWR p/n:**  
A = 10 cycles, +25°C  
B = 10 cycles, -55°C & +85°C  
C = 10 cycles, -55°C & +85°C before Weibull  
Z = None (required for CWR19 & CWR29 only)

**□ = Packaging:**

**For TBJ p/n:**  
B = Bulk  
R = 7" T&R  
S = 13" T&R  
**For CWR p/n:**  
Bulk = Standard  
VTR = 7" T&R  
VTR13 = 13" T&R  
W = Waffle



# Surface Mount Military



## CWR11 - MIL-PRF-55365/8 and TBJ COTS-Plus

AVX Part Number	QPL Part Number (for reference only)	DC rated voltage (85°C) (volts)	Cap (nom) µF	DC Leakage (max)			Dissipation Factor (max)			ESR (max) 100 kHz +25°C (Ohms)	Case Size
				+25°C (µA)	+85°C (µA)	+125°C (µA)	+25°C (%)	+85/125°C (%)	-55°C (%)		
TBJA105(*)010C□#@00++	CWR11FK105*+□	10	1.0	0.5	5.0	6.0	4	6	6	10.0	A
TBJA155(*)010C□#@00++	CWR11FK155*+□	10	1.5	0.5	5.0	6.0	6	6	9	8.0	A
TBJA225(*)010C□#@00++	CWR11FK225*+□	10	2.2	0.5	5.0	6.0	6	9	9	8.0	A
TBJA335(*)010C□#@00++		10	3.3	0.5	5.0	10.0	6	9	10	5.5	A
TBJB335(*)010C□#@00++	CWR11FK335*+□	10	3.3	0.5	5.0	6.0	6	9	9	5.5	B
TBJA475(*)010C□#@00++		10	4.7	0.5	5.0	10.0	6	9	10	5.0	A
TBJB475(*)010C□#@00++	CWR11FK475*+□	10	4.7	0.5	5.0	6.0	6	9	9	4.5	B
TBJA685(*)010C□#@00++		10	6.8	0.7	7.0	14.0	6	9	10	4.0	A
TBJB685(*)010C□#@00++	CWR11FK685*+□	10	6.8	0.7	7.0	8.4	6	9	9	3.5	B
TBJA106(*)010C□#@00++		10	10.0	1.0	10.0	20.0	6	9	10	3.0	A
TBJA106(*)010L□#@00++		10	10.0	1.0	10.0	20.0	6	9	10	1.8	A
TBJB106(*)010C□#@00++		10	10.0	1.0	10.0	20.0	6	9	10	2.5	B
TBJC106(*)010C□#@00++		10	10.0	1.0	10.0	20.0	6	9	10	2.5	C
TBJA156(*)010C□#@00++		10	15.0	1.6	16.0	32.0	6	9	10	3.2	A
TBJB156(*)010C□#@00++		10	15.0	1.6	16.0	32.0	6	9	10	2.8	B
TBJC156(*)010C□#@00++	CWR11FK156*+□	10	15.0	1.5	15.0	18.0	6	6	9	2.5	C
TBJB226(*)010C□#@00++		10	22.0	2.2	22.0	44.0	6	9	10	2.4	B
TBJB226(*)010L□#@00++		10	22.0	2.2	22.0	44.0	6	9	10	0.700	B
TBJC226(*)010C□#@00++		10	22.0	2.2	22.0	44.0	6	9	10	1.0	C
TBJB336(*)010C□#@00++		10	33.0	3.3	33.0	66.0	6	9	10	1.8	B
TBJC336(*)010C□#@00++		10	33.0	3.3	33.0	66.0	6	9	10	1.6	C
TBJD336(*)010C□#@00++	CWR11FK336*+□	10	33.0	3.3	33.0	39.6	6	9	9	1.1	D
TBJC476(*)010C□#@00++		10	47.0	4.7	47.0	94.0	6	9	10	1.2	C
TBJD476(*)010C□#@00++	CWR11FK476*+□	10	47.0	4.7	47.0	56.4	6	9	9	0.9	D
TBJC686(*)010C□#@00++		10	68.0	6.8	68.0	136.0	8	10	12	1.2	C
TBJD686(*)010C□#@00++		10	68.0	6.8	68.0	136.0	6	9	10	0.9	D
TBJC107(*)010C□#@00++		10	100.0	10.0	100.0	200.0	8	10	12	1.2	C
TBJC107(*)010L□#@00++		10	100.0	10.0	100.0	200.0	8	10	12	0.200	C
TBJD107(*)010C□#@00++		10	100.0	10.0	100.0	200.0	6	9	10	0.9	D
TBJD107(*)010L□#@00++		10	100.0	10.0	100.0	200.0	6	9	10	0.100	D
TBJD157(*)010C□#@00++		10	150.0	15.0	150.0	300.0	8	10	12	0.9	D
TBJD157(*)010L□#@00++		10	150.0	15.0	150.0	300.0	8	10	12	0.100	D
TBJD227M010C□#@00++		10	220.0	22.0	220.0	440.0	8	10	12	0.9	D
TBJD227M010L□#@00++		10	220.0	22.0	220.0	440.0	8	10	12	0.150	D
TBJE227(*)010C□#@00++		10	220.0	22.0	220.0	440.0	8	10	12	0.9	E
TBJE227(*)010L□#@00++		10	220.0	22.0	220.0	440.0	8	10	12	0.100	E
TBJD337M010C□#@00++		10	330.0	33.0	330.0	660.0	8	10	12	0.9	D
TBJD337M010L□#@00++		10	330.0	33.0	330.0	660.0	8	10	12	0.150	D
TBJE337(*)010C□#@00++		10	330.0	33.0	330.0	660.0	8	10	12	0.9	E
TBJE337(*)010L□#@00++		10	330.0	33.0	330.0	660.0	8	10	12	0.060	E
TBJV337(*)010L□#@00++		10	330.0	33.0	330.0	660.0	8	10	12	0.100	V
TBJE477M010C□#@00++		10	470.0	47.0	470.0	940.0	10	12	14	0.9	E
TBJE477M010L□#@00++		10	470.0	47.0	470.0	940.0	10	12	14	0.050	E
TBJV477(*)010L□#@00++		10	470.0	47.0	470.0	940.0	10	12	14	0.100	V

Following the voltage code, C designates Standard, L designates Low ESR Ratings

### Part Number Designations

**\* = Tolerance:**

M = ±20%  
K = ±10%  
J = ±5% (Special order only)

**# = Inspection Level:**

S = Std. Conformance  
L = Group A  
**For CWR p/n:**  
M = Military Conformance per MIL-PRF-55365

**@ = Failure Rate Level:**

Weibull: B = 0.1%/1000 Hrs.  
(90% C = 0.01%/1000 Hrs. conf.)  
Comm: Z = Non ER

**+ = Surge Option:**

**For TBJ p/n:**  
00 = None  
23 = 10 cycles, +25°C  
24 = 10 cycles, -55°C & +85°C  
45 = 10 cycles, -55°C & +85°C before Weibull  
**For CWR p/n:**  
A = 10 cycles, +25°C  
B = 10 cycles, -55°C & +85°C  
C = 10 cycles, -55°C & +85°C before Weibull  
Z = None (required for CWR19 & CWR29 only)

**□ = Packaging:**

**For TBJ p/n:**  
B = Bulk  
R = 7" T&R  
S = 13" T&R  
**For CWR p/n:**  
Bulk = Standard  
VTR = 7" T&R  
VTR13 = 13" T&R  
W = Waffle



# Surface Mount Military



## CWR11 - MIL-PRF-55365/8 and TBJ COTS-Plus

AVX Part Number	QPL Part Number (for reference only)	DC rated voltage (85°C) (volts)	Cap (nom) µF	DC Leakage (max)			Dissipation Factor (max)			ESR (max) 100 kHz +25°C (Ohms)	Case Size
				+25°C (µA)	+85°C (µA)	+125°C (µA)	+25°C (%)	+85/125°C (%)	-55°C (%)		
TBJA684(*)016C□#@00++	CWR11HK684*@+□	16	0.68	0.5	5.0	6.0	4	6	6	12.0	A
TBJA105(*)016C□#@00++	CWR11HK105*@+□	16	1.0	0.5	5.0	6.0	4	6	6	10.0	A
TBJA155(*)016C□#@00++	CWR11HK155*@+□	16	1.5	0.5	5.0	6.0	6	9	9	8.0	A
TBJA225(*)016C□#@00++		16	2.2	0.5	5.0	10.0	6	9	10	5.5	A
TBJB225(*)016C□#@00++	CWR11HK225*@+□	16	2.2	0.5	5.0	6.0	6	9	9	5.0	B
TBJA335(*)016C□#@00++		16	3.3	0.5	5.0	10.0	6	9	10	5.0	A
TBJA335(*)016L□#@00++		16	3.3	0.5	5.0	10.0	6	9	10	3.5	A
TBJB335(*)016C□#@00++	CWR11HK335*@+□	16	3.3	0.5	5.0	6.0	6	8	9	5.0	B
TBJA475(*)016C□#@00++		16	4.7	0.8	8.0	16.0	6	9	10	4.0	A
TBJB475(*)016C□#@00++	CWR11HK475*@+□	16	4.7	0.7	7.0	8.4	6	9	9	4.0	B
TBJA685(*)016C□#@00++		16	6.8	1.1	11.0	22.0	6	9	10	2.5	A
TBJB685(*)016C□#@00++		16	6.8	1.1	11.0	22.0	6	9	10	2.5	B
TBJC685(*)016C□#@00++		16	6.8	1.1	11.0	22.0	6	9	10	2.5	C
TBJB106(*)016C□#@00++		16	10.0	1.6	16.0	32.0	6	9	10	2.8	B
TBJC106(*)016C□#@00++	CWR11HK106*@+□	16	10.0	1.6	16.0	19.2	6	8	9	2.5	C
TBJB156(*)016C□#@00++		16	15.0	2.4	24.0	48.0	6	9	10	2.5	B
TBJB156(*)016L□#@00++		16	15.0	2.4	24.0	48.0	6	9	10	0.800	B
TBJC156(*)016C□#@00++		16	15.0	2.4	24.0	48.0	6	9	10	1.8	C
TBJB226(*)016C□#@00++		16	22.0	3.6	36.0	72.0	6	9	10	2.3	B
TBJC226(*)016C□#@00++		16	22.0	3.6	36.0	72.0	6	9	10	1.6	C
TBJC226(*)016L□#@00++		16	22.0	3.6	36.0	72.0	6	9	10	0.375	C
TBJD226(*)016C□#@00++	CWR11HK226*@+□	16	22.0	3.3	33.0	39.6	6	8	9	1.1	D
TBJC336(*)016C□#@00++		16	33.0	5.3	53.0	106.0	6	9	10	1.5	C
TBJC336(*)016L□#@00++		16	33.0	5.3	53.0	106.0	6	9	10	0.300	C
TBJD336(*)016C□#@00++	CWR11HK336*@+□	16	33.0	5.3	53.0	106.0	6	9	9	0.9	D
TBJC476(*)016C□#@00++		16	47.0	7.6	76.0	152.0	6	9	10	1.5	C
TBJC476(*)016L□#@00++		16	47.0	7.6	76.0	152.0	6	9	10	0.350	C
TBJD476(*)016C□#@00++		16	47.0	7.6	76.0	152.0	6	9	10	0.9	D
TBJD476(*)016L□#@00++		16	47.0	7.6	76.0	152.0	6	9	10	0.150	D
TBJD686(*)016C□#@00++		16	68.0	10.9	109.0	218.0	6	9	10	0.9	D
TBJD107(*)016C□#@00++		16	100.0	16.0	160.0	320.0	6	9	10	0.9	D
TBJD107(*)016L□#@00++		16	100.0	16.0	160.0	320.0	6	9	10	0.125	D
TBJE107(*)016C□#@00++		16	100.0	16.0	160.0	320.0	6	9	10	0.9	E
TBJE107(*)016L□#@00++		16	100.0	16.0	160.0	320.0	6	9	10	0.100	E
TBJD157M016C□#@00++		16	150.0	24.0	240.0	480.0	6	9	10	0.9	D
TBJD157M016L□#@00++		16	150.0	24.0	240.0	480.0	6	9	10	0.150	D
TBJV157(*)016L□#@00++		16	150.0	24.0	480.0	960.0	6	8	10	0.045	V
TBJV227(*)016L□#@00++		16	220.0	35.2	352.0	704.0	8	10	12	0.150	V

Following the voltage code, C designates Standard, L designates Low ESR Ratings

### Part Number Designations

**\* = Tolerance:**

M = ±20%  
K = ±10%  
J = ±5% (Special order only)

**# = Inspection Level:**

S = Std. Conformance  
L = Group A  
**For CWR p/n:**  
M = Military Conformance per MIL-PRF-55365

**@ = Failure Rate Level:**

Weibull: B = 0.1%/1000 Hrs.  
(90% C = 0.01%/1000 Hrs. conf.)  
Comm: Z = Non ER

**+ = Surge Option:**

**For TBJ p/n:**  
00 = None  
23 = 10 cycles, +25°C  
24 = 10 cycles, -55°C & +85°C  
45 = 10 cycles, -55°C & +85°C before Weibull  
**For CWR p/n:**  
A = 10 cycles, +25°C  
B = 10 cycles, -55°C & +85°C  
C = 10 cycles, -55°C & +85°C before Weibull  
Z = None (required for CWR19 & CWR29 only)

**□ = Packaging:**

**For TBJ p/n:**  
B = Bulk  
R = 7" T&R  
S = 13" T&R  
**For CWR p/n:**  
Bulk = Standard  
TR = 7" T&R  
TR13 = 13" T&R  
W = Waffle



# Surface Mount Military



## CWR11 - MIL-PRF-55365/8 and TBJ COTS-Plus

AVX Part Number	QPL Part Number (for reference only)	DC rated voltage (85°C) (volts)	Cap (nom) µF	DC Leakage (max)			Dissipation Factor (max)			ESR (max) 100 kHz +25°C (Ohms)	Case Size
				+25°C (µA)	+85°C (µA)	+125°C (µA)	+25°C (%)	+85/125°C (%)	-55°C (%)		
TBJA474(*)020C□#@00++	CWR11JK474*+□	20	0.47	0.5	5.0	6.0	4	6	6	14.0	A
TBJA684(*)020C□#@00++	CWR11JK684*+□	20	0.68	0.5	5.0	6.0	4	6	6	12.0	A
TBJA105(*)020C□#@00++	CWR11JK105*+□	20	1.0	0.5	5.0	6.0	4	6	6	10.0	A
TBJA155(*)020C□#@00++		20	1.5	0.5	5.0	10.0	6	8	10	6.5	A
TBJB155(*)020C□#@00++	CWR11JK155*+□	20	1.5	0.5	5.0	6.0	6	9	9	6.0	B
TBJB225(*)020C□#@00++	CWR11JK225*+□	20	2.2	0.5	5.0	6.0	6	8	9	5.0	B
TBJB335(*)020C□#@00++	CWR11JK335*+□	20	3.3	0.7	7.0	8.4	6	9	9	4.0	B
TBJA475(*)020C□#@00++		20	4.7	1.0	10.0	20.0	6	8	10	4.0	A
TBJA475(*)020L□#@00++		20	4.7	1.0	10.0	20.0	6	8	10	1.8	A
TBJB475(*)020C□#@00++		20	4.7	2.0	20.0	40.0	6	8	10	3.0	B
TBJC475(*)020C□#@00++	CWR11JK475*+□	20	4.7	1.0	10.0	12.0	6	8	9	3.0	C
TBJB685(*)020C□#@00++		20	6.8	1.4	14.0	28.0	6	8	10	2.5	B
TBJC685(*)020C□#@00++	CWR11JK685*+□	20	6.8	1.4	14.0	16.8	6	9	9	2.4	C
TBJB106(*)020C□#@00++		20	10.0	0.7	7.0	14.0	6	8	10	2.1	B
TBJB106(*)020L□#@00++		20	10.0	0.7	7.0	14.0	6	8	10	1.0	B
TBJC106(*)020C□#@00++		20	10.0	1.4	14.0	28.0	6	8	10	1.9	C
TBJB156(*)020C□#@00++		20	15.0	3.0	30.0	60.0	6	8	10	2.0	B
TBJC156(*)020C□#@00++		20	15.0	3.0	30.0	60.0	6	8	10	1.7	C
TBJD156(*)020C□#@00++	CWR11JK156*+□	20	15.0	3.0	30.0	36.0	6	8	9	1.1	D
TBJC226(*)020C□#@00++		20	22.0	4.4	44.0	88.0	6	8	10	1.6	C
TBJD226(*)020C□#@00++	CWR11JK226*+□	20	22.0	4.4	44.0	52.8	6	9	9	0.9	D
TBJC336(*)020C□#@00++		20	33.0	6.6	66.0	132.0	6	8	10	1.5	C
TBJD336(*)020C□#@00++		20	33.0	6.6	66.0	132.0	6	8	10	0.9	D
TBJD336(*)020L□#@00++		20	33.0	6.6	66.0	132.0	6	8	10	0.200	D
TBJD476(*)020C□#@00++		20	47.0	9.4	94.0	188.0	6	8	10	0.9	D
TBJD686(*)020C□#@00++		20	68.0	13.6	136.0	272.0	6	8	10	0.9	D
TBJE686(*)020C□#@00++		20	68.0	13.6	136.0	272.0	6	8	10	0.9	E
TBJE686(*)020L□#@00++		20	68.0	13.6	136.0	272.0	6	8	10	0.150	E
TBJV107(*)020L□#@00++		20	100.0	20.0	200.0	400.0	8	10	12	0.200	V
TBJA334(*)025C□#@00++	CWR11KK334*+□	25	0.33	0.5	5.0	6.0	4	6	6	15.0	A
TBJA474(*)025C□#@00++	CWR11KK474*+□	25	0.47	0.5	5.0	6.0	4	6	6	14.0	A
TBJA684M025C□#@00++		25	0.68	0.5	5.0	10.0	4	6	8	10.0	A
TBJB684(*)025C□#@00++	CWR11KK684*+□	25	0.68	0.5	5.0	6.0	4	6	6	7.5	B
TBJA105(*)025C□#@00++		25	1.0	0.5	5.0	10.0	4	6	8	8.0	A
TBJB105(*)025C□#@00++	CWR11KK105*+□	25	1.0	0.5	5.0	6.0	4	6	6	6.5	B
TBJA155(*)025C□#@00++		25	1.5	0.5	5.0	10.0	6	8	10	7.5	A
TBJA155(*)025L□#@00++		25	1.5	0.5	5.0	10.0	6	8	10	3.0	A
TBJB155(*)025C□#@00++	CWR11KK155*+□	25	1.5	0.5	5.0	6.0	6	8	9	6.5	B
TBJA225(*)025C□#@00++		25	2.2	0.5	5.0	10.0	6	8	10	7.0	A
TBJB225(*)025C□#@00++		25	2.2	0.5	5.0	10.0	6	8	10	4.5	B
TBJC225(*)025C□#@00++	CWR11KK225*+□	25	2.2	0.6	6.0	7.2	6	9	9	3.5	C
TBJB335(*)025C□#@00++		25	3.3	0.5	5.0	10.0	6	8	10	3.5	B
TBJC335(*)025C□#@00++	CWR11KK335*+□	25	3.3	0.9	9.0	10.8	6	8	9	3.5	C
TBJB475(*)025C□#@00++		25	4.7	1.2	12.0	24.0	6	8	10	2.8	B
TBJB475(*)025L□#@00++		25	4.7	1.2	12.0	24.0	6	8	10	1.5	B
TBJC475(*)025C□#@00++	CWR11KK475*+□	25	4.7	1.2	12.0	14.4	6	9	9	2.5	C
TBJB685(*)025C□#@00++		25	6.8	1.7	17.0	34.0	6	8	10	2.8	B
TBJC685(*)025C□#@00++		25	6.8	1.7	17.0	34.0	6	8	10	2.0	C
TBJD685(*)025C□#@00++	CWR11KK685*+□	25	6.8	1.7	17.0	20.4	6	9	9	1.4	D
TBJC106(*)025C□#@00++		25	10.0	2.5	25.0	50.0	6	8	10	1.8	C
TBJC106(*)025L□#@00++		25	10.0	2.5	25.0	50.0	6	8	10	0.500	C
TBJD106(*)025C□#@00++	CWR11KK106*+□	25	10.0	2.5	25.0	30.0	6	8	9	1.2	D
TBJD156(*)025C□#@00++	CWR11KK156*+□	25	15.0	3.8	38.0	45.6	6	9	9	1.0	D
TBJC226(*)025C□#@00++		25	22.0	5.5	55.0	110.0	6	8	10	1.4	C
TBJD226(*)025C□#@00++		25	22.0	5.5	55.0	110.0	6	8	10	0.9	D
TBJD226(*)025L□#@00++		25	22.0	5.5	55.0	110.0	6	8	10	0.200	D
TBJD336(*)025C□#@00++		25	33.0	8.3	83.0	166.0	6	8	10	0.9	D
TBJE336(*)025C□#@00++		25	33.0	8.3	83.0	166.0	6	8	10	0.9	E
TBJE336(*)025L□#@00++		25	33.0	8.3	83.0	166.0	6	8	10	0.300	E
TBJD476M025C□#@00++		25	47.0	11.8	118.0	236.0	6	8	10	0.9	D
TBJD476M025L□#@00++		25	47.0	11.8	118.0	236.0	6	8	10	0.250	D
TBJV686(*)025L□#@00++		25	68.0	17.0	170.0	340.0	8	10	12	0.150	V

Following the voltage code, C designates Standard, L Designates low ESR Ratings

### Part Number Designations

**\* = Tolerance:**

M = ±20%  
K = ±10%  
J = ±5% (Special order only)

**# = Inspection Level:**

S = Std. Conformance  
L = Group A  
**For CWR p/n:**  
M = Military Conformance per MIL-PRF-55365

**@ = Failure Rate Level:**

Weibull: B = 0.1%/1000 Hrs.  
(90% C = 0.01%/1000 Hrs. conf.)  
Comm: Z = Non ER

**+ = Surge Option:**

**For TBJ p/n:**  
00 = None  
23 = 10 cycles, +25°C  
24 = 10 cycles, -55°C & +85°C  
45 = 10 cycles, -55°C & +85°C before Weibull  
**For CWR p/n:**  
A = 10 cycles, +25°C  
B = 10 cycles, -55°C & +85°C  
C = 10 cycles, -55°C & +85°C before Weibull  
Z = None (required for CWR19 & CWR29 only)

**□ = Packaging:**

**For TBJ p/n:**  
B = Bulk  
R = 7" T&R  
S = 13" T&R  
**For CWR p/n:**  
Bulk = Standard  
VTR = 7" T&R  
VTR13 = 13" T&R  
W = Waffle





# Surface Mount Military



## CWR11 - MIL-PRF-55365/8 and TBJ COTS-Plus

AVX Part Number	QPL Part Number (for reference only)	DC rated voltage (85°C) (volts)	Cap (nom) µF	DC Leakage (max)			Dissipation Factor (max)			ESR (max) 100 kHz +25°C (Ohms)	Case Size
				+25°C (µA)	+85°C (µA)	+125°C (µA)	+25°C (%)	+85/125°C (%)	-55°C (%)		
TBJA104(*)035C□#@00++	CWR11MK104*+□	35	0.1	0.5	5.0	6.0	4	6	6	24.0	A
TBJA154(*)035C□#@00++	CWR11MK154*+□	35	0.15	0.5	5.0	6.0	4	6	6	21.0	A
TBJA224(*)035C□#@00++	CWR11MK224*+□	35	0.22	0.5	5.0	6.0	4	6	6	18.0	A
TBJA334(*)035C□#@00++	CWR11MK334*+□	35	0.33	0.5	5.0	6.0	4	6	6	15.0	A
TBJA474M035C□#@00++		35	0.47	0.5	5.0	10.0	4	6	8	12.0	A
TBJB474(*)035C□#@00++	CWR11MK474*+□	35	0.47	0.5	5.0	6.0	4	6	6	10.0	B
TBJA684M035C□#@00++		35	0.68	0.5	5.0	10.0	4	6	8	8.0	A
TBJB684(*)035C□#@00++	CWR11MK684*+□	35	0.68	0.5	5.0	6.0	4	6	6	8.0	B
TBJA105(*)035C□#@00++		35	1.00	0.5	5.0	10.0	4	6	6	7.5	A
TBJB105(*)035C□#@00++	CWR11MK105*+□	35	1.0	0.5	5.0	6.0	4	6	6	6.5	B
TBJA155(*)035C□#@00++		35	1.5	0.5	5.0	10.0	6	8	9	7.5	A
TBJB155(*)035C□#@00++		35	1.5	0.5	5.0	10.0	6	8	9	5.2	B
TBJC155(*)035C□#@00++	CWR11MK155*+□	35	1.5	0.5	5.0	6.0	6	8	9	4.5	C
TBJB225(*)035C□#@00++		35	2.2	0.8	8.0	16.0	6	8	9	4.2	B
TBJC225(*)035C□#@00++	CWR11MK225*+□	35	2.2	0.8	8.0	9.6	6	8	9	3.5	C
TBJB335(*)035C□#@00++		35	3.3	1.2	12.0	24.0	6	8	9	3.5	B
TBJC335(*)035C□#@00++	CWR11MK335*+□	35	3.3	1.2	12.0	14.4	6	8	9	2.5	C
TBJB475(*)035C□#@00++		35	4.7	1.6	16.0	32.0	6	8	9	3.1	B
TBJC475(*)035C□#@00++		35	4.7	1.6	16.0	32.0	6	8	9	2.2	C
TBJC475(*)035L□#@00++		35	4.7	1.6	16.0	32.0	6	8	9	0.600	C
TBJD475(*)035C□#@00++	CWR11MK475*+□	35	4.7	1.7	17.0	20.4	6	8	9	1.5	D
TBJC685(*)035C□#@00++		35	6.8	2.4	24.0	48.0	6	9	9	1.8	C
TBJD685(*)035C□#@00++	CWR11MK685*+□	35	6.8	2.4	24.0	28.8	6	9	9	1.3	D
TBJC106(*)035C□#@00++		35	10.0	3.5	35.0	70.0	6	9	9	1.6	C
TBJD106(*)035C□#@00++		35	10.0	3.5	35.0	70.0	6	9	9	1.0	D
TBJD106(*)035L□#@00++		35	10.0	3.5	35.0	70.0	6	9	9	0.300	D
TBJC156(*)035C□#@00++		35	15.0	5.3	53.0	106.0	6	9	9	1.4	C
TBJD156(*)035C□#@00++		35	15.0	5.3	53.0	106.0	6	9	9	0.9	D
TBJD156(*)035L□#@00++		35	15.0	5.3	53.0	106.0	6	9	9	0.300	D
TBJD226(*)035C□#@00++		35	22.0	7.7	77.0	154.0	6	9	9	0.9	D
TBJD226(*)035L□#@00++		35	22.0	7.7	77.0	154.0	6	9	9	0.400	D
TBJE226(*)035C□#@00++		35	22.0	7.7	77.0	154.0	6	9	9	0.9	E
TBJE226(*)035L□#@00++		35	22.0	7.7	77.0	154.0	6	9	9	0.300	E
TBJD336M035C□#@00++		35	33.0	11.6	116.0	232.0	6	9	9	0.9	D
TBJD336M035L□#@00++		35	33.0	11.6	116.0	232.0	6	9	9	0.300	D
TBJA104(*)050C□#@00++	CWR11NK104*+□	50	0.10	0.5	5.0	12.0	6	8	8	22.0	A
TBJA154M050C□#@00++		50	0.15	0.5	5.0	10.0	4	6	6	21.0	A
TBJB154(*)050C□#@00++	CWR11NK154*+□	50	0.15	0.5	5.0	6.0	4	6	6	17.0	B
TBJA224M050C□#@00++		50	0.22	0.5	5.0	10.0	4	6	6	18.0	A
TBJB224(*)050C□#@00++	CWR11NK224*+□	50	0.22	0.5	5.0	6.0	4	6	6	14.0	B
TBJB334(*)050C□#@00++	CWR11NK334*+□	50	0.33	0.5	5.0	6.0	4	6	6	12.0	B
TBJC474(*)050C□#@00++	CWR11NK474*+□	50	0.47	0.5	5.0	6.0	4	6	6	8.0	C
TBJC684(*)050C□#@00++	CWR11NK684*+□	50	0.68	0.5	5.0	6.0	4	6	6	7.0	C
TBJC105(*)050C□#@00++	CWR11NK105*+□	50	1.0	0.5	5.0	6.0	4	6	6	6.0	C
TBJC155(*)050C□#@00++		50	1.5	0.8	8.0	16.0	6	8	9	5.0	C
TBJD155(*)050C□#@00++	CWR11NK155*+□	50	1.5	0.8	8.0	9.6	6	8	9	4.0	D
TBJD225(*)050C□#@00++	CWR11NK225*+□	50	2.2	1.1	11.0	13.2	6	8	9	2.5	D
TBJD335(*)050C□#@00++	CWR11NK335*+□	50	3.3	1.7	17.0	20.4	6	9	9	2.0	D
TBJD475(*)050C□#@00++	CWR11NK475*+□	50	4.7	2.4	24.0	28.8	6	9	9	1.5	D
TBJD685(*)050C□#@00++		50	6.8	3.4	34.0	68.0	6	6	6	1.0	D

Following the voltage code, C designates Standard, L Designates low ESR Ratings

### Part Number Designations

**\* = Tolerance:**

M = ±20%  
K = ±10%  
J = ±5% (Special order only)

**# = Inspection Level:**

S = Std. Conformance  
L = Group A  
**For CWR p/n:**  
M = Military Conformance per MIL-PRF-55365

**@ = Failure Rate Level:**

Weibull: B = 0.1%/1000 Hrs.  
(90% C = 0.01%/1000 Hrs. conf.)  
Comm: Z = Non ER

**+ = Surge Option:**

**For TBJ p/n:**  
00 = None  
23 = 10 cycles, +25°C  
24 = 10 cycles, -55°C & +85°C  
45 = 10 cycles, -55°C & +85°C before Weibull  
**For CWR p/n:**  
A = 10 cycles, +25°C  
B = 10 cycles, -55°C & +85°C  
C = 10 cycles, -55°C & +85°C before Weibull  
Z = None (required for CWR19 & CWR29 only)

**□ = Packaging:**

**For TBJ p/n:**  
B = Bulk  
R = 7" T&R  
S = 13" T&R  
**For CWR p/n:**  
Bulk = Standard  
VTR = 7" T&R  
VTR13 = 13" T&R  
W = Waffle



# TBC Series



## CWR15 Military Approved Microchip



AVX announces the world's smallest military approved tantalum chip capacitors. The CWR15 offers 0603, 0805 and 1206 case sizes in capacitance/voltage combinations previously only available in much larger packages. The revolutionary AVX TACmicrochip technology offers designers significant

opportunity to downsize circuits for military and aerospace applications. The product is manufactured in the AVX Tantalum high reliability facility in Biddeford, Maine which is also home to the CWR09, CWR11, CWR19 and CWR29 product lines.

### CASE DIMENSIONS: millimeters (inches)

Case Code	Length (L)	Width (W)	Height (H)	Term. Width (W <sub>t</sub> ) ±0.10 (±0.004)
L	1.60+0.25/-0.15 (0.063+0.010/-0.006)	0.85+0.20/-0.10 (0.033+0.008/-0.004)	0.85+0.20/-0.10 (0.033+0.008/-0.004)	0.15+0.35/-0.00 (0.006+0.014/-0.000)
R	2.00+0.25/-0.15 (0.079+0.010/-0.006)	1.35+0.20/-0.10 (0.053+0.008/-0.004)	1.35+0.20/-0.10 (0.053+0.008/-0.004)	0.15+0.35/-0.00 (0.006+0.014/-0.000)
A	3.20±0.20 (0.126±0.008)	1.60±0.20 (0.063±0.008)	1.60±0.20 (0.063±0.008)	0.15+0.35/-0.00 (0.006+0.014/-0.000)

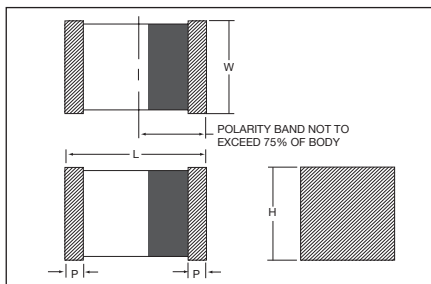

### PART NUMBERING SYSTEM

**CWR15**

**Style**  
Tantalum  
Chip  
Capacitor

**F**

**Voltage**  
C = 4Vdc  
D = 6Vdc  
F = 10Vdc

**K**

**Termination  
Finish**  
Solder Fused

**225**

**Capacitance  
Code**  
pF code: 1st two  
digits represent  
significant figures  
3rd digit represents  
number of zeros to  
follow

**M**

**Capacitance  
Tolerance**  
J = ±5%  
K = ±10%  
M = ±20%

**B**

**Product  
Level  
Designator**  
Weibull FRL  
B = 0.1  
C = 0.01  
D = 0.001

**L**

**Case  
Size**  
L  
R  
A

**B**

**Surge  
Current  
Option**  
A = +25°C after  
Weibull  
B = -55°C to +85°C  
after Weibull  
C = -55°C to +85°C  
before Weibull

### AVAILABLE RANGES

### (LETTER DENOTES CASE SIZE)

Capacitance		Voltage Rating DC (V <sub>R</sub> ) at 85°C				
Cap. (µF)	Code	4V	6V	10V	15V	20V
0.47	474					
0.68	684					
1.0	105					
1.5	155					
2.2	225			L		
3.3	335			R/L		
4.7	475		L	R		
6.8	685	L	R	R		
10	106	R	R	R		
15	156	R	R	A		
22	226	R	R			
33	336	R	A			
47	476	A	A			
68	686	A				

Further extensions of the CWR15 product are planned for later in 2005. A new case size will be added, and the voltage range will be extended to 20 volts. Ratings of 100µF at 4 volts to 10µF at 20 volts will be included in this extension of the product line.



# Section 2: Niobium Oxide Capacitors\*

## OxiCap™ NOJ, NOS, NOM Series

### DEVELOPMENT ROADMAP

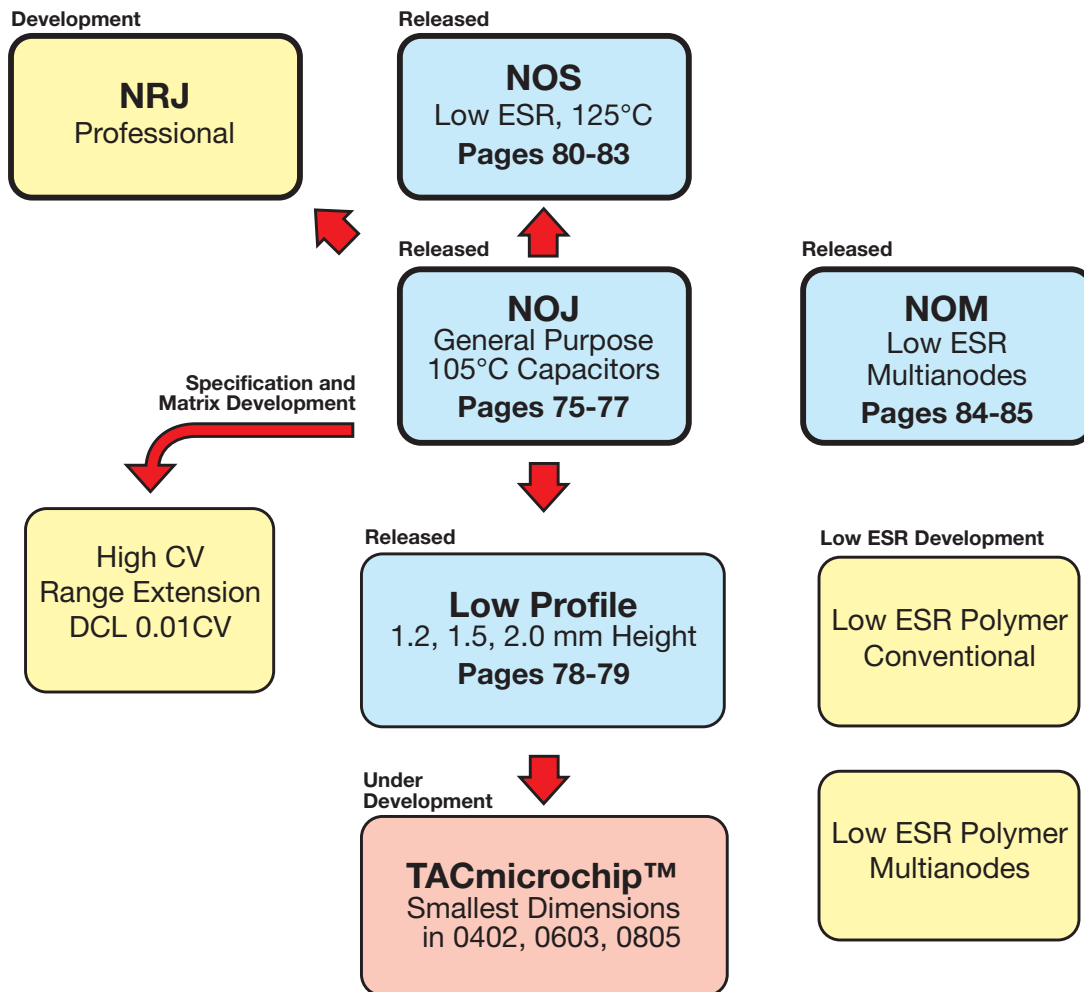

\*Niobium Oxide Capacitors are manufactured and sold under patent license from Cabot Corporation, Boyertown, Pennsylvania U.S.A.

# OxiCap™ NOJ Series



## Niobium Oxide Capacitor

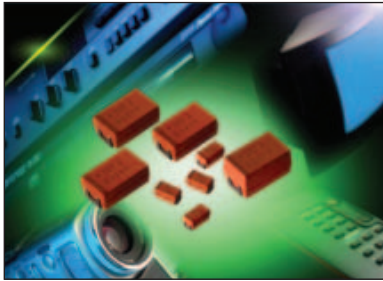

**Cost versus Performance** is a key requirement for consumer electronic products. A new solid electrolyte capacitor **OxiCap™** has been developed by AVX in standard EIA case sizes in order to meet this requirement as a higher performance alternative to aluminum and other SMT capacitor technologies currently on the market. The **OxiCap™ non-burn<sup>1</sup>** technology is based on **NbO niobium oxide ceramic material** as the anodic material processed through the same manufacturing process as tantalum capacitors. Nb<sub>2</sub>O<sub>5</sub> dielectric in

combination to self-healing MnO<sub>2</sub> cathode is a basis for a good reliability level **0.5%/1000 hrs.** within a temperature range up to **105°C** and rated voltage **<6V** (rail voltage <5V). Electrical parameters are similar to general tantalum specifications. NbO and MnO<sub>2</sub> are widely available materials. The laser coded **orange molded body** gives total traceability.

- Reduced Voltage Derating
- Failed OxiCap™ will not burn up to category voltage

### CASE DIMENSIONS: millimeters (inches)

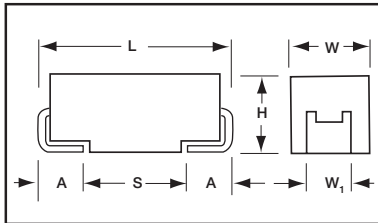

Code	EIA Code	L±0.20 (0.008)	W+0.20 (0.008) -0.10 (0.004)	H+0.20 (0.008) -0.10 (0.004)	W <sub>1</sub> ±0.20 (0.008)	A+0.30 (0.012) -0.20 (0.008)	S Min.
A	3216-18	3.20 (0.126)	1.60 (0.063)	1.60 (0.063)	1.20 (0.047)	0.80 (0.031)	1.10 (0.043)
B	3528-21	3.50 (0.138)	2.80 (0.110)	1.90 (0.075)	2.20 (0.087)	0.80 (0.031)	1.40 (0.055)
C	6032-28	6.00 (0.236)	3.20 (0.126)	2.60 (0.102)	2.20 (0.087)	1.30 (0.051)	2.90 (0.114)
D	7343-31	7.30 (0.287)	4.30 (0.169)	2.90 (0.114)	2.40 (0.094)	1.30 (0.051)	4.40 (0.173)
E	7343-43	7.30 (0.287)	4.30 (0.169)	4.10 (0.162)	2.40 (0.094)	1.30 (0.051)	4.40 (0.173)
V	7361-38	7.30 (0.287)	6.10 (0.240)	3.45 ±0.30 (0.136±0.012)	3.10 (0.120)	1.40 (0.055)	4.40 (0.173)
Z*	7361-45	7.30 (0.287)	6.10 (0.240)	4.30 (0.169)	3.10 (0.120)	1.40 (0.055)	4.40 (0.173)

W<sub>1</sub> dimension applies to the termination width for A dimensional area only. \*under development

### HOW TO ORDER

**NOJ**

Type

**D**

Case Size

**107**

Capacitance Code  
1st two digits represent significant figures, 3rd digit represents multiplier in pF

**M**

Capacitance Tolerance  
M = ±20%

**006**

Rated DC Voltage  
001 = 1.8Vdc  
002 = 2.5Vdc  
004 = 4Vdc  
006 = 6.3Vdc  
010 = 10Vdc

**RWJ**

Packaging  
R = Lead Free 7" Reel  
S = Lead Free 13" Reel

### TECHNICAL SPECIFICATIONS

Technical Data:	All technical data relate to an ambient temperature of +25°C is not stated						
Capacitance Range:	4.7µF to 1500µF						
Capacitance Tolerance:	±20%						
Leakage Current DCL:	0.02CV						
Rated Voltage DC (V <sub>R</sub> )	≤+85°C:	1.8	2.5	4	6.3	10	
Category Voltage (V <sub>C</sub> )	≤+105°C:	1.2	1.7	2.7	4	7	
Surge Voltage (V <sub>S</sub> )	≤+85°C:	2.3	3.3	5.2	8	13	
	≤+105°C:	1.6	2.2	3.4	5	8	
Temperature Range:	-55°C to +105°C						
Reliability:	0.5% per 1000 hours at 85°C, V <sub>R</sub> , 0.1Ω/V series impedance, 60% confidence level Meets requirements of AEC-Q200						



# OxiCap™ NOJ Series



## Niobium Oxide Capacitor

### CAPACITANCE AND RATED VOLTAGE RANGE (LETTER DENOTES CASE SIZE)

Capacitance		Rated Voltage DC ( $V_R$ ) to 85°C / 0.66 DC to 105°C / 0.5 DC to 125°C				
Cap. ( $\mu$ F)	Code	1.8V (x)	2.5V (e)	4V (G)	6.3V (J)	10V (A)
4.7	475				A	A
6.8	685				A	A
10	106				A	A/B
15	156			A	B	B
22	226		A	A/B	B	B/C
33	336	A	A/B	B	B/C	C
47	476	A/B	B	B/C	C	C
68	686	B	B/C	B/C	C	D
100	107	B/C	B/C	C	C/D	D
150	157	B/C	C	C/D	C/D	E
220	227	C	C	C/D	D/E	V
330	337	C	C/D	D	E	
470	477	C/D	D/E	D/E	V	
680	687	D	E	V	Z	
1000	108	E	V	Z		
1500	158	V	Z			
2200	228	Z				

Developmental Ratings - subject to change

Z case = 4.5mm height V



LEAD-FREE

LEAD-FREE COMPATIBLE  
COMPONENT



HALOGEN-FREE COMPOUNDS

ENVIRONMENTAL FRIENDLY  
COMPONENT



NON-BURN  
NON-SMOKE

# OxiCap™ NOJ Series



## Niobium Oxide Capacitor

### RATINGS & PART NUMBER REFERENCE

AVX Part No.	Case Size	Capacitance (µF)	Rated Voltage (V)	DCL (µA) Max.	DF % Max.	ESR Max. (Ω) @100kHz	100kHz Ripple Current (A)			100kHz Ripple Voltage (V)		
							25°C	85°C	105°C	25°C	85°C	105°C
<b>1.8 Volt @ 85°C (1.2 Volt @ 105°C)</b>												
NOJB476M001#	B	47	1.8	1.7	6	1.6	0.252	0.227	0.101	0.404	0.364	0.162
NOJB686M001#	B	68	1.8	2.5	6	1.5	0.261	0.235	0.104	0.391	0.352	0.156
NOJB107M001#	B	100	1.8	3.6	6	1.4	0.270	0.243	0.108	0.378	0.340	0.151
NOJC107M001#	C	100	1.8	3.6	6	0.4	0.574	0.517	0.230	0.230	0.207	0.092
NOJC157M001#	C	150	1.8	5.4	8	0.4	0.574	0.517	0.230	0.230	0.207	0.092
NOJC227M001#	C	220	1.8	8.0	8	0.4	0.574	0.517	0.230	0.230	0.207	0.092
<b>2.5 Volt @ 85°C (1.7 Volt @ 105°C)</b>												
NOJA226M002#	A	22	2.5	1.1	6	1.9	0.218	0.196	0.087	0.414	0.372	0.165
NOJA336M002#	A	33	2.5	1.7	6	1.7	0.230	0.207	0.092	0.391	0.352	0.156
NOJB336M002#	B	33	2.5	1.7	6	1.7	0.245	0.220	0.098	0.416	0.375	0.167
NOJB476M002#	B	47	2.5	2.4	6	1.6	0.252	0.227	0.101	0.404	0.364	0.162
NOJC686M002#	C	68	2.5	3.4	6	0.5	0.514	0.462	0.206	0.257	0.231	0.103
NOJC107M002#	C	100	2.5	5.0	6	0.4	0.574	0.517	0.230	0.230	0.207	0.092
NOJC157M002#	C	150	2.5	7.5	6	0.4	0.574	0.517	0.230	0.230	0.207	0.092
NOJC227M002#	C	220	2.5	11.0	8	0.4	0.574	0.517	0.230	0.230	0.207	0.092
NOJD337M002#	D	330	2.5	16.5	10	0.3	0.775	0.697	0.310	0.232	0.209	0.093
NOJD477M002#	D	470	2.5	23.5	10	0.3	0.775	0.697	0.310	0.323	0.209	0.093
NOJE477M002#	E	470	2.5	23.5	10	0.3	0.812	0.731	0.325	0.244	0.219	0.097
NOJE687M002#	E	680	2.5	34.0	12	0.3	0.812	0.731	0.325	0.244	0.219	0.097
NOJV108M002#	V	1000	2.5	50.0	18	0.3	1.000	0.900	0.400	0.300	0.270	0.120
<b>4 Volt @ 85°C (2.7 Volt @ 105°C)</b>												
NOJA156M004#	A	15	4	1.2	6	2	0.212	0.191	0.085	0.424	0.382	0.170
NOJA226M004#	A	22	4	1.8	6	1.9	0.218	0.196	0.087	0.414	0.372	0.165
NOJB226M004#	B	22	4	1.8	6	1.9	0.232	0.209	0.093	0.440	0.396	0.176
NOJB336M004#	B	33	4	2.6	6	1.7	0.245	0.220	0.098	0.416	0.375	0.167
NOJB476M004#	B	47	4	3.8	6	1.6	0.252	0.227	0.101	0.404	0.364	0.162
NOJC476M004#	C	47	4	3.8	6	0.5	0.514	0.462	0.206	0.257	0.231	0.103
NOJC686M004#	C	68	4	5.4	6	0.5	0.514	0.462	0.206	0.257	0.231	0.103
NOJC107M004#	C	100	4	8.0	6	0.4	0.574	0.517	0.230	0.230	0.207	0.092
NOJC157M004#	C	150	4	12.0	6	0.4	0.574	0.517	0.230	0.230	0.207	0.092
NOJD157M004#	D	150	4	12.0	6	0.3	0.775	0.697	0.310	0.232	0.209	0.093
NOJD227M004#	D	220	4	17.6	8	0.4	0.671	0.604	0.268	0.268	0.241	0.107
NOJD337M004#	D	330	4	26.4	8	0.3	0.775	0.697	0.310	0.232	0.209	0.093
NOJE477M004#	E	470	4	37.6	12	0.3	0.812	0.731	0.325	0.244	0.219	0.097
NOJV687M004#	V	680	4	54.4	14	0.3	1.000	0.900	0.400	0.300	0.270	0.120
<b>6.3 Volt @ 85°C (4 Volt @ 105°C)</b>												
NOJA475M006#	A	4.7	6.3	1.1	6	3.1	0.170	0.153	0.068	0.528	0.475	0.211
NOJA685M006#	A	6.8	6.3	1.1	6	2.6	0.186	0.167	0.074	0.484	0.435	0.193
NOJA106M006#	A	10	6.3	1.2	6	2.2	0.202	0.182	0.081	0.445	0.400	0.178
NOJB156M006#	B	15	6.3	1.8	6	2	0.226	0.203	0.090	0.452	0.406	0.181
NOJB226M006#	B	22	6.3	2.6	6	1.9	0.232	0.209	0.093	0.440	0.396	0.176
NOJB336M006#	B	33	6.3	4.0	6	1.7	0.245	0.220	0.098	0.416	0.375	0.167
NOJC336M006#	C	33	6.3	4.0	6	0.5	0.514	0.462	0.206	0.257	0.231	0.103
NOJC476M006#	C	47	6.3	5.7	6	0.5	0.514	0.462	0.206	0.257	0.231	0.103
NOJC686M006#	C	68	6.3	8.2	6	0.5	0.514	0.462	0.206	0.257	0.231	0.103
NOJC107M006#	C	100	6.3	12.0	8	0.4	0.574	0.517	0.230	0.230	0.207	0.092
NOJD107M006#	D	100	6.3	12.0	6	0.4	0.671	0.604	0.268	0.268	0.241	0.107
NOJD157M006#	D	150	6.3	18.0	6	0.4	0.671	0.604	0.268	0.268	0.241	0.107
NOJD227M006#	D	220	6.3	26.4	8	0.4	0.671	0.604	0.268	0.268	0.241	0.107
NOJE227M006#	E	220	6.3	26.4	12	0.4	0.704	0.633	0.281	0.281	0.253	0.113
NOJE337M006#	E	330	6.3	39.6	12	0.3	0.812	0.731	0.325	0.244	0.219	0.097
NOJV477M006#	V	470	6.3	56.4	12	0.3	1.000	0.900	0.400	0.300	0.270	0.120
<b>10 Volt @ 85°C (7 Volt @ 105°C)</b>												
NOJA475M010#	A	4.7	10	1.0	6	3.1	0.170	0.153	0.068	0.528	0.475	0.211
NOJA685M010#	A	6.8	10	1.4	6	2.6	0.186	0.167	0.074	0.484	0.435	0.193
NOJA106M010#	A	10	10	2.0	6	2.2	0.202	0.182	0.081	0.445	0.400	0.178
NOJB106M010#	B	10	10	2.0	6	2.2	0.215	0.194	0.086	0.474	0.426	0.189
NOJB156M010#	B	15	10	3.0	6	2	0.226	0.203	0.090	0.452	0.406	0.181
NOJB226M010#	B	22	10	4.4	6	1.8	0.238	0.214	0.095	0.428	0.386	0.171

All technical data relates to an ambient temperature of +25°C. Capacitance and DF are measured at 120Hz, 0.5RMS with DC bias of 2.2V. DCL is measured at rated voltage after 5 minutes.

NOTE: AVX reserves the rights to supply higher voltage rating in the same case size, to the same reliability standards.



# OxiCap™ NOJ Series



## Low Profile

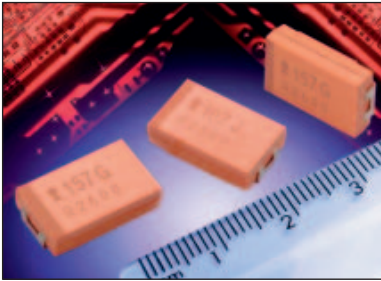

Five additional case sizes are available in the NOJ range offering low profile solid niobium oxide capacitors. Designed for applications where maximum height of components above or below board are of prime consideration, this height of 1.2,

1.5 and 2.0mm equates to that of a standard integrated circuit package after mounting. The S&T footprints are identical to the A&B case size parts and the W&Y footprints to C&D case size parts.

### CASE DIMENSIONS: millimeters (inches)

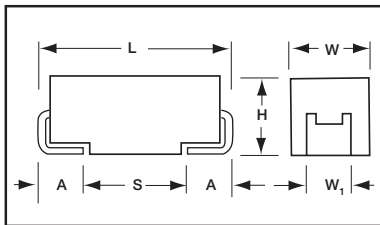

For part marking see page 121

Code	EIA Code	L±0.20 (0.008)	W+0.20 (0.008) -0.10 (0.004)	H Max	W <sub>1</sub> ±0.20 (0.008)	A+0.30 (0.012) -0.20 (0.008)	S Min.
R*	2012-12	2.05 (0.081)	1.30 (0.051)	1.0±0.1 (0.039±0.004)	1.20 (0.047)	0.50 (0.020)	0.85 (0.033)
P	2012-15	2.05 (0.081)	1.35 (0.053)	1.0±0.1 (0.039±0.004)	1.20 (0.047)	0.50 (0.020)	0.85 (0.033)
S**	3216-12	3.20 (0.126)	1.60 (0.063)	1.20 (0.047)	1.20 (0.047)	0.80 (0.031)	1.10 (0.043)
T**	3528-12	3.50 (0.138)	2.80 (0.110)	1.20 (0.047)	2.20 (0.087)	0.80 (0.031)	1.40 (0.055)
W**	6032-15	6.00 (0.236)	3.20 (0.126)	1.50 (0.059)	2.20 (0.087)	1.30 (0.051)	2.90 (0.114)
Y**	7343-20	7.30 (0.287)	4.30 (0.169)	2.00 (0.079)	2.40 (0.094)	1.30 (0.051)	4.40 (0.173)
X**	7343-15	7.30 (0.287)	4.30 (0.169)	1.50 (0.059)	2.40 (0.094)	1.30 (0.051)	4.40 (0.173)

\* 0805 Footprint Compatible  
 \*\* Low Profile Versions of A & B & C & D Case, respectively  
 W<sub>1</sub> dimension applies to the termination width for A dimensional area only.  
 Pad Stand-off is 0.1±0.1.

### HOW TO ORDER

**NOJ**

Type

**Y**

Case Size

**107**

Capacitance Code  
 1st two digits represent significant figures, 3rd digit represents multiplier in pF

**M**

Capacitance Tolerance  
 M = ±20%

**006**

Rated DC Voltage  
 001 = 1.8Vdc  
 002 = 2.5Vdc  
 004 = 4Vdc  
 006 = 6.3Vdc  
 010 = 10Vdc

**RWJ**

Packaging  
 R = Lead Free 7" Reel  
 S = Lead Free 13" Reel

### TECHNICAL SPECIFICATIONS

Technical Data:	All technical data relate to an ambient temperature of +25°C is not stated						
Capacitance Range:	10µF to 330µF						
Capacitance Tolerance:	±20%						
Leakage Current DCL:	0.02CV						
Rated Voltage DC (V <sub>R</sub> )	≤+85°C:	1.8	2.5	4	6.3	10	
Category Voltage (V <sub>C</sub> )	≤+105°C:	1.2	1.7	2.7	4	7	
Surge Voltage (V <sub>S</sub> )	≤+85°C:	2.3	3.3	5.2	8	13	
	≤+105°C:	1.6	2.2	3.4	5	8	
Temperature Range:	-55°C to +105°C						
Reliability:	0.5% per 1000 hours at 85°C, V <sub>R</sub> , 0.1Ω/V series impedance, 60% confidence level Meets requirements of AEC-Q200						



# OxiCap™ NOJ Series



## Low Profile

### CAPACITANCE AND RATED VOLTAGE RANGE (LETTER DENOTES CASE SIZE)

Capacitance		Rated Voltage DC (V <sub>R</sub> ) to 85°C / 0.66 DC to 105°C / 0.5 DC to 125°C				
Cap. (µF)	Code	1.8V (x)	2.5V (e)	4V (G)	6.3V (J)	10V (A)
1.0	105				R	R
1.5	155				R	
2.2	225				R	R
3.3	335			R	R	P/S
4.7	475		R	R	P/S	T
6.8	685	R	R	P/R/S	T	T
10	106	R	P/R/S	P/R/S/T	T	
15	156	P/R/S	P/R/S/T	P/T		
22	226	P/R/S/T	P/T	T		W
33	336	P/T	T		W	
47	476	T		W	W	
68	686	T	W	W	X/Y	Y
100	107	W	W	W/X	Y	
150	157	W	W/X	Y	Y	
220	227	W/X	Y	Y		
330	337	Y	Y			
470	477	Y				

Developmental Ratings - subject to change

### RATINGS & PART NUMBER REFERENCE

AVX Part No.	Case Size	Capacitance (µF)	Rated Voltage (V)	DCL (µA) Max.	DF % Max.	ESR Max. (Ω) @100kHz	100kHz Ripple Current Ratings (A)			100kHz Ripple Voltage Ratings (V)		
							25°C	85°C	105°C	25°C	85°C	105°C
<b>1.8 Volt @ 85°C (1.2 Volt @ 105°C)</b>												
NOJS156*001#	S	15	1.8	1.0	6	2.0	0.197	0.178	0.079	0.395	0.335	0.158
NOJT226*001#	T	22	1.8	1.0	6	1.8	0.231	0.208	0.092	0.416	0.374	0.166
NOJT336*001#	T	33	1.8	1.2	6	1.7	0.238	0.214	0.095	0.404	0.364	0.162
NOJW107*001#	W	100	1.8	3.6	6	0.15	0.849	0.764	0.339	0.127	0.115	0.051
NOJX227*001#	X	220	1.8	8.0	8	0.4	0.548	0.493	0.219	0.219	0.197	0.088
NOJY337*001#	Y	330	1.8	11.9	8	0.3	0.707	0.636	0.283	0.212	0.191	0.085
NOJY477*001#	Y	470	1.8	16.9	8	0.3	0.707	0.636	0.283	0.212	0.191	0.085
<b>2.5 Volt @ 85°C (1.7 Volt @ 105°C)</b>												
NOJP106*002#	P	10	2.5	1.0	6	4.5	0.126	0.114	0.051	0.569	0.512	0.228
NOJS106*002#	S	10	2.5	1.0	6	2.2	0.188	0.169	0.075	0.414	0.373	0.166
NOJT156*002#	T	15	2.5	1.0	6	2.0	0.219	0.197	0.088	0.438	0.394	0.175
NOJT226*002#	T	22	2.5	1.1	6	1.9	0.225	0.202	0.090	0.427	0.384	0.171
NOJW686*002#	W	68	2.5	3.4	6	0.4	0.520	0.468	0.208	0.208	0.187	0.083
NOJX157*002#	X	150	2.5	7.5	6	0.4	0.548	0.493	0.219	0.219	0.197	0.088
NOJY227*002#	Y	220	2.5	11.0	8	0.4	0.612	0.551	0.245	0.245	0.220	0.098
NOJY337*002#	Y	330	2.5	16.5	10	0.3	0.707	0.636	0.283	0.212	0.191	0.085
<b>4 Volt @ 85°C (2.7 Volt @ 105°C)</b>												
NOJP685*004#	P	6.8	4.0	1.0	6	5.3	0.117	0.105	0.047	0.618	0.556	0.247
NOJS685*004#	S	6.8	4.0	1.0	6	2.6	0.173	0.156	0.069	0.450	0.405	0.180
NOJP106*004#	P	10	4.0	1.0	16	4.5	0.126	0.114	0.051	0.569	0.512	0.228
NOJT106*004#	T	10	4.0	1.0	6	2.2	0.209	0.188	0.084	0.460	0.414	0.184
NOJT156*004#	T	15	4.0	1.2	6	2	0.219	0.197	0.088	0.438	0.394	0.175
NOJW476*004#	W	47	4.0	3.8	6	0.5	0.465	0.418	0.186	0.232	0.209	0.093
NOJX107*004#	X	100	4.0	8.0	6	0.4	0.548	0.493	0.219	0.219	0.197	0.088
NOJY157*004#	Y	150	4.0	12.0	6	0.4	0.612	0.551	0.245	0.245	0.220	0.098
NOJY227*004#	Y	220	4.0	17.6	10	0.4	0.612	0.551	0.245	0.245	0.220	0.098
<b>6.3 Volt @ 85°C (4 Volt @ 105°C)</b>												
NOJP475*006#	P	4.7	6.3	1.0	6	6.1	0.109	0.098	0.043	0.663	0.596	0.265
NOJS475*006#	S	4.7	6.3	1.0	6	3.2	0.156	0.141	0.062	0.500	0.450	0.200
NOJT685*006#	T	6.8	6.3	1.0	6	2.6	0.192	0.173	0.077	0.500	0.450	0.200
NOJT106*006#	T	10	6.3	1.2	6	2.2	0.209	0.188	0.084	0.460	0.414	0.184
NOJW336*006#	W	33	6.3	4.0	6	0.5	0.465	0.418	0.186	0.232	0.209	0.093
NOJX686*006#	X	68	6.3	8.2	6	0.5	0.490	0.441	0.196	0.245	0.220	0.098
NOJY686*006#	Y	68	6.3	8.2	6	0.5	0.548	0.493	0.219	0.274	0.246	0.110
NOJY107*006#	Y	100	6.3	12.0	6	0.4	0.612	0.551	0.245	0.245	0.220	0.098
NOJY157*006#	Y	150	6.3	18.0	6	0.4	0.612	0.551	0.245	0.245	0.220	0.098

All technical data relates to an ambient temperature of +25°C. Capacitance and DF are measured at 120Hz, 0.5RMS with DC bias of 2.2V. DCL is measured at rated voltage after 5 minutes.

NOTE: AVX reserves the rights to supply higher voltage rating in the same case size, to the same reliability standards.



LEAD-FREE  
LEAD-FREE COMPATIBLE  
COMPONENT



HALOGEN-FREE COMPOUNDS  
ENVIRONMENTAL FRIENDLY  
COMPONENT



NON-BURN  
NON-SMOKE



# OxiCap™ NOS Low ESR Series



## Niobium Oxide Capacitor



**NOS Low ESR** series of **OxiCap™** niobium oxide capacitors have been developed in order to offer significant **Cost versus Performance** value as the key requirement for mass manufactured electronic products. A new solid electrolyte capacitor **OxiCap™** has been developed by AVX in standard EIA SMT case sizes. The **OxiCap™ non-burn** technology is based on **NbO niobium oxide ceramic material** as the anodic material processed through the same manufacturing process as tantalum capacitors. Nb<sub>2</sub>O<sub>5</sub> dielectric in combina-

tion to self-healing MnO<sub>2</sub> cathode is a basis for an excellent reliability level **0.2%/1000 hrs.** within a temperature range up to **125°C** and rated voltage **<6V** (rail voltage <5V). Electrical parameters are similar to general **low ESR** tantalum specifications. NbO and MnO<sub>2</sub> are widely available materials. The laser coded **orange molded body** gives total traceability.

- Reduced Voltage Derating
- Failed OxiCap™ will not burn up to category voltage

### CASE DIMENSIONS: millimeters (inches)

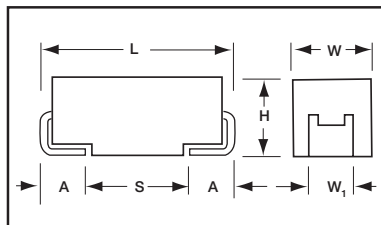

Code	EIA Code	L±0.20 (0.008)	W+0.20 (0.008) -0.10 (0.004)	H+0.20 (0.008) -0.10 (0.004)	W <sub>1</sub> ±0.20 (0.008)	A+0.30 (0.012) -0.20 (0.008)	S Min.
P*	2012-15	2.05 (0.081)	1.30 (0.051)	1.0 ±0.1 (0.039±0.004)	1.20 (0.047)	0.50 (0.020)	0.85 (0.033)
A	3216-18	3.20 (0.126)	1.60 (0.063)	1.60 (0.063)	1.20 (0.047)	0.80 (0.031)	1.10 (0.043)
B	3528-21	3.50 (0.138)	2.80 (0.110)	1.90 (0.075)	2.20 (0.087)	0.80 (0.031)	1.40 (0.055)
C	6032-28	6.00 (0.236)	3.20 (0.126)	2.60 (0.102)	2.20 (0.087)	1.30 (0.051)	2.90 (0.114)
D	7343-31	7.30 (0.287)	4.30 (0.169)	2.90 (0.114)	2.40 (0.094)	1.30 (0.051)	4.40 (0.173)
E	7343-43	7.30 (0.287)	4.30 (0.169)	4.10 (0.162)	2.40 (0.094)	1.30 (0.051)	4.40 (0.173)
Y	7343-20	7.30 (0.287)	4.30 (0.169)	2.00 Max (0.079)	2.40 (0.094)	1.30 (0.051)	4.40 (0.173)
V	7361-38	7.30 (0.287)	6.10 (0.240)	3.45 ±0.30 (0.136±0.012)	3.10 (0.120)	1.40 (0.055)	4.40 (0.173)
Z*	7361-45	7.30 (0.287)	6.10 (0.240)	4.30 (0.169)	3.10 (0.120)	1.40 (0.055)	4.40 (0.173)

W<sub>1</sub> dimension applies to the termination width for A dimensional area only. \* -under development

### HOW TO ORDER

**NOS**

Type

**D**

Case Size

**107**

Capacitance Code  
1st two digits represent significant figures, 3rd digit represents multiplier in pF

**M**

Capacitance Tolerance  
M = ±20%

**006**

Rated DC Voltage  
001 = 1.8Vdc  
002 = 2.5Vdc  
004 = 4Vdc  
006 = 6.3Vdc  
010 = 10Vdc

**R**

Packaging  
R = Lead Free  
7" Reel  
S = Lead Free  
13" Reel

**0100**

ESR  
ESR value in mOhms@100kHz

### TECHNICAL SPECIFICATIONS

Technical Data:	All technical data relate to an ambient temperature of +25°C is not stated				
Capacitance Range:	10µF to 1000µF				
Capacitance Tolerance:	±20%				
Leakage Current DCL:	0.02CV				
Rated Voltage DC (V <sub>R</sub> )	≤+85°C:	1.8	2.5	4	6.3
Category Voltage (V <sub>C</sub> )	≤+125°C:	0.9	1.3	2	3
Surge Voltage (V <sub>S</sub> )	≤+85°C:	2.3	3.3	5.2	8
	≤+125°C:	1.2	1.7	2.6	4
Temperature Range:	-55°C to +125°C				
Reliability:	0.2% per 1000 hours at 85°C, V <sub>R</sub> , 0.1Ω/V series impedance, 60% confidence level Meets requirements of AEC-Q200				



# OxiCap™ NOS Low ESR Series



## Niobium Oxide Capacitor

### CAPACITANCE AND RATED VOLTAGE RANGE (LETTER DENOTES CASE SIZE)

Capacitance		Rated Voltage DC (V <sub>R</sub> ) to 85°C / 0.66 DC to 105°C / 0.5 DC to 125°C			
Cap. (µF)	Code	1.8V (x)	2.5V (e)	4.0V (G)	6.3V (J)
4.7	475				
6.8	685				
10	106				A(2000)
15	156			A(1500)	B(600)
22	226		A(900)	B(600)	B(600)
33	336	A(900)	B(600)*	B(600)	B(600) C(500) W(250)
47	476	B(500)	B(500)	B(500) C(300) W(150)	C(300)
68	686	B(500)	C(200) W(150)	C(200)	C(75,200) X(100) Y(100)
100	107	B(350) C(200) W(150)	C(150)	C(70,150) X(100)	C(150) D(80,100) Y(100)
150	157	C(150)	C(65,150) X(100)	C(90,150) Y(100)	D(70,100) Y(100)
220	227	C(125) X(100)	C(80,125) Y(100)	D(60,100) Y(100)	D(60,100) E(80,100)
330	337	C(125) Y(100)	D(100) Y(100)	D(100) E(100)	E(80,100)
470	477	D(100) Y(100)	D(55,100) E(100)	E(75,100)	V(75)
680	687	D(100) E(100)	E(60)	V(75)	
1000	108	E(60)	V(50)		
1500	158	V(50)	Z		
2200	228	Z			

Developmental Ratings - subject to change

Violet - Please Contact Manufacturer



LEAD-FREE

LEAD-FREE COMPATIBLE  
COMPONENT



HALOGEN-FREE COMPOUNDS

ENVIRONMENTAL FRIENDLY  
COMPONENT



NON-BURN  
NON-SMOKE

# OxiCap™ NOS Low ESR Series



## Niobium Oxide Capacitor

### RATINGS & PART NUMBER REFERENCE

AVX Part No.	Case Size	Capacitance (µF)	Rated Voltage(V)	DCL (µA)	DF %	ESR Max. (mΩ) @100kHz	100kHz Ripple Current Ratings (A)			100kHz Ripple Voltage Ratings (V)		
							25°C	85°C	125°C	25°C	85°C	125°C
<b>1.8 Volt @ 85°C (1.2 Volt @ 105°C, 0.9V @ 125°C)</b>												
NOSB107M001#0350	B	100	1.8	3.6	6	350	0.540	0.486	0.216	0.189	0.170	0.076
NOSW107M001#0150	W	100	1.8	3.6	6	150	0.849	0.764	0.339	0.127	0.115	0.051
NOSC227M001#0125	C	220	1.8	8.0	8	125	1.028	0.925	0.411	0.128	0.116	0.051
NOSX227M001#0100	X	220	1.8	8.0	8	100	1.095	0.986	0.438	0.110	0.099	0.044
NOSY337M001#0100	Y	330	1.8	11.9	8	100	1.225	1.102	0.490	0.122	0.110	0.049
NOSY477M001#0100	Y	470	1.8	16.9	8	100	1.225	1.102	0.490	0.122	0.110	0.049
<b>2.5 Volt @ 85°C (1.7 Volt @ 105°C, 1.3V @ 125°C)</b>												
NOSA226M002#0900	A	22	2.5	1.1	6	900	0.316	0.285	0.126	0.285	0.256	0.114
NOSB336M002#0600	B	33	2.5	1.7	6	600	0.412	0.371	0.165	0.247	0.223	0.099
NOSB476M002#0500	B	47	2.5	2.4	6	500	0.452	0.406	0.181	0.226	0.203	0.090
NOSC686M002#0200	C	68	2.5	3.4	6	200	0.812	0.731	0.325	0.162	0.146	0.065
NOSW686M002#0150	W	68	2.5	3.4	6	150	0.849	0.764	0.339	0.127	0.115	0.051
NOSC107M002#0150	C	100	2.5	5.0	6	150	0.938	0.844	0.375	0.141	0.127	0.056
NOSC157M002#0065	C	150	2.5	7.6	6	65	1.425	1.283	0.570	0.093	0.083	0.037
NOSC157M002#0150	C	150	2.5	7.6	6	150	0.938	0.844	0.375	0.141	0.127	0.056
NOSX157M002#0100	X	150	2.5	7.5	6	100	1.095	0.986	0.438	0.110	0.099	0.044
NOSC227M002#0080	C	220	2.5	11.0	8	80	1.285	1.156	0.514	0.103	0.092	0.041
NOSC227M002#0125	C	220	2.5	11.0	8	125	1.028	0.925	0.411	0.128	0.116	0.051
NOSY227M002#0100	Y	220	2.5	11.0	8	100	1.225	1.102	0.490	0.122	0.110	0.049
NOSD337M002#0100	D	330	2.5	16.5	10	100	1.342	1.207	0.537	0.134	0.121	0.054
NOSY337M002#0100	Y	330	2.5	16.5	10	100	1.225	1.102	0.490	0.122	0.110	0.049
NOSD447M002#0055	D	470	2.5	23.5	10	55	1.809	1.628	0.724	0.099	0.090	0.040
NOSD447M002#0100	D	470	2.5	23.5	10	100	1.342	1.207	0.537	0.134	0.121	0.054
NOSE477M002#0100	E	470	2.5	23.5	10	100	1.407	1.266	0.563	0.141	0.127	0.056
NOSE687M002#0060	E	680	2.5	34.0	12	60	1.817	1.635	0.727	0.109	0.098	0.044
NOSV108M002#0050	V	1000	2.5	50.0	18	50	2.449	2.205	0.980	0.122	0.110	0.049
<b>4 Volt @ 85°C (2.7 Volt @ 105°C, 2V @ 125°C)</b>												
NOSA156M004#1500	A	15	4	1.2	6	1500	0.245	0.220	0.098	0.367	0.331	0.147
NOSB226M004#0600	B	22	4	1.8	6	600	0.412	0.371	0.165	0.247	0.223	0.099
NOSB336M004#0600	B	33	4	2.6	6	600	0.412	0.371	0.165	0.247	0.223	0.099
NOSB476M004#0500	B	47	4	3.8	6	500	0.452	0.406	0.181	0.226	0.203	0.090
NOSC476M004#0300	C	47	4	3.8	6	300	0.663	0.597	0.265	0.199	0.179	0.080
NOSW476M004#0150	W	47	4	3.8	6	150	0.849	0.764	0.339	0.127	0.115	0.051
NOSC686M004#0200	C	68	4	5.4	6	200	0.812	0.731	0.325	0.162	0.146	0.065
NOSC107M004#0070	C	100	4	8.0	6	70	1.373	1.236	0.549	0.096	0.087	0.038
NOSC107M004#0150	C	100	4	8.0	6	150	0.938	0.844	0.375	0.141	0.127	0.056
NOSX107M004#0100	X	100	4	8.0	6	100	1.095	0.986	0.438	0.110	0.099	0.044
NOSC157M004#0090	C	150	4	12.0	6	90	1.211	1.090	0.484	0.109	0.098	0.044
NOSC157M004#0150	C	150	4	12.0	6	150	0.938	0.844	0.375	0.141	0.127	0.056
NOSY157M004#0100	Y	150	4	12.0	6	100	1.225	1.102	0.490	0.122	0.110	0.049
NOSD227M004#0060	D	220	4	17.6	8	60	1.732	1.559	0.693	0.104	0.094	0.042
NOSD227M004#0100	D	220	4	17.6	8	100	1.342	1.207	0.537	0.134	0.121	0.054
NOSY227M004#0100	Y	220	4	17.6	10	100	1.225	1.102	0.490	0.122	0.110	0.049
NOSD337M004#0100	D	330	4	26.4	8	100	1.342	1.207	0.537	0.134	0.121	0.054
NOSE337M004#0100	E	330	4	26.4	8	100	1.407	1.266	0.563	0.141	0.127	0.056
NOSE477M004#0075	E	470	4	37.6	12	75	1.625	1.462	0.650	0.122	0.110	0.049
NOSE477M004#0100	E	470	4	37.6	12	100	1.407	1.266	0.563	0.141	0.127	0.056
NOSV687M004#0075	V	680	4	54.4	14	75	2.000	1.800	0.800	0.150	0.135	0.060

**Violet - Please Contact Manufacturer**

All technical data relates to an ambient temperature of +25°C. Capacitance and DF are measured at 120Hz, 0.5RMS with DC bias of 2.2V. DCL is measured at rated voltage after 5 minutes.

NOTE: AVX reserves the rights to supply higher voltage rating in the same case size, to the same reliability standards.

# OxiCap™ NOS Low ESR Series



## Niobium Oxide Capacitor

### RATINGS & PART NUMBER REFERENCE

AVX Part No.	Case Size	Capacitance (μF)	Rated Voltage(V)	DCL (μA)	DF %	ESR Max. (mΩ) @100kHz	100kHz Ripple Current Ratings (A)			100kHz Ripple Voltage Ratings (V)		
							25°C	85°C	125°C	25°C	85°C	125°C
<b>6.3 Volt @ 85°C (4 Volt @ 105°C, 3V @ 125°C)</b>												
NOSA106M006#2000	A	10	6.3	1.2	6	2000	0.212	0.191	0.085	0.424	0.382	0.170
NOSB156M006#0600	B	15	6.3	1.8	6	600	0.412	0.371	0.165	0.247	0.223	0.099
NOSB226M006#0600	B	22	6.3	2.6	6	600	0.412	0.371	0.165	0.247	0.223	0.099
NOSB336M006#0600	B	33	6.3	4.0	6	600	0.412	0.371	0.165	0.247	0.223	0.099
NOSC336M006#0500	C	33	6.3	4.0	6	500	0.514	0.462	0.206	0.257	0.231	0.103
NOSW336M006#0250	W	33	6.3	4.0	6	250	0.657	0.592	0.263	0.164	0.148	0.066
NOSC476M006#0300	C	47	6.3	5.7	6	300	0.663	0.597	0.265	0.199	0.179	0.080
NOSC686M006#0075	C	68	6.3	8.2	6	75	1.327	1.194	0.531	0.099	0.090	0.040
NOSC686M006#0200	C	68	6.3	8.2	6	200	0.812	0.731	0.325	0.162	0.146	0.065
NOSX686M006#0100	X	68	6.3	8.2	6	100	1.095	0.986	0.438	0.110	0.099	0.044
NOSY686M006#0100	Y	68	6.3	8.2	6	100	1.225	1.102	0.490	0.122	0.110	0.049
NOSC107M006#0150	C	100	6.3	12.0	8	150	0.938	0.844	0.375	0.141	0.127	0.056
NOSD107M006#0080	D	100	6.3	12.0	6	80	1.500	1.350	0.600	0.120	0.108	0.048
NOSD107M006#0100	D	100	6.3	12.0	6	100	1.342	1.207	0.537	0.134	0.121	0.054
NOSY107M006#0100	Y	100	6.3	12.0	6	100	1.225	1.102	0.490	0.122	0.110	0.049
NOSD157M006#0070	D	150	6.3	18.0	6	70	1.604	1.443	0.641	0.112	0.101	0.045
NOSD157M006#0100	D	150	6.3	18.0	6	100	1.342	1.207	0.537	0.134	0.121	0.054
NOSY157M006#0100	Y	150	6.3	18.0	6	100	1.225	1.102	0.490	0.122	0.110	0.049
NOSD227M006#0060	D	220	6.3	26.4	8	60	1.732	1.559	0.693	0.104	0.094	0.042
NOSD227M006#0100	D	220	6.3	26.4	8	100	1.342	1.207	0.537	0.134	0.121	0.054
NOSE227M006#0080	E	220	6.3	26.4	12	80	1.573	1.416	0.629	0.126	0.113	0.050
NOSE227M006#0100	E	220	6.3	26.4	12	100	1.407	1.266	0.563	0.141	0.127	0.056
NOSE337M006#0080	E	330	6.3	39.6	12	80	1.573	1.416	0.629	0.126	0.113	0.050
NOSE337M006#0100	E	330	6.3	39.6	12	100	1.407	1.266	0.563	0.141	0.127	0.056
NOSV477M006#0075	V	470	6.3	56.4	12	75	2.000	1.800	0.800	0.150	0.135	0.060

All technical data relates to an ambient temperature of +25°C. Capacitance and DF are measured at 120Hz, 0.5RMS with DC bias of 2.2V. DCL is measured at rated voltage after 5 minutes.

NOTE: AVX reserves the rights to supply higher voltage rating in the same case size, to the same reliability standards.

# OxiCap™ NOM Low ESR Multianodes



## Niobium Oxide Capacitor

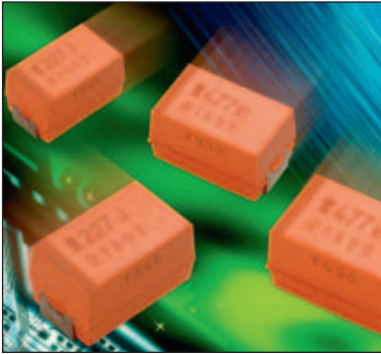

Low ESR down to 30mΩ and high ripple current are the key parameters of the multianode construction within the E case package available now with niobium oxide anode – OxiCap™ product family.

Niobium oxide technology benefits such as high resistance and non-burn together with excellent reliability and reduced derating are maintained within this multi-anode series.

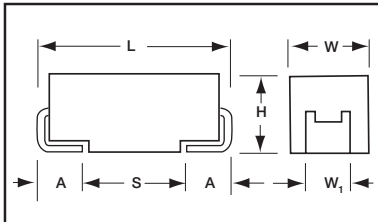

### CASE DIMENSIONS: millimeters (inches)

Code	EIA Code	L±0.20 (0.008)	W+0.20 (0.008) -0.10 (0.004)	H+0.20 (0.008) -0.10 (0.004)	W <sub>1</sub> ±0.20 (0.008)	A+0.30 (0.012) -0.20 (0.008)	S Min.
E	7343-43	7.30 (0.287)	4.30 (0.169)	4.10 (0.162)	2.40 (0.094)	1.30 (0.051)	4.40 (0.173)

W<sub>1</sub> dimension applies to the termination width for A dimensional area only.

### HOW TO ORDER

**NOM**

Type

**E**

Case Size

**227**

Capacitance Code  
1st two digits represent significant figures, 3rd digit represents multiplier in pF

**M**

Capacitance Tolerance  
M = ±20%

**006**

Rated DC Voltage  
001 = 1.8Vdc  
002 = 2.5Vdc  
004 = 4Vdc  
006 = 6.3Vdc

**R**

Packaging  
R = Lead Free 7" Reel  
S = Lead Free 13" Reel

**0040**

ESR  
ESR value in mOhms@100kHz

### TECHNICAL SPECIFICATIONS

Technical Data:	All technical data relate to an ambient temperature of +25°C is not stated				
Capacitance Range:	220µF to 470µF				
Capacitance Tolerance:	±20%				
Leakage Current DCL:	0.02CV				
Rated Voltage DC (V <sub>R</sub> )	≤+85°C:	1.8	2.5	4	6.3
Category Voltage (V <sub>C</sub> )	≤+125°C:	0.9	1.3	2	3
Surge Voltage (V <sub>S</sub> )	≤+85°C:	2.3	3.3	5.2	8
	≤+125°C:	1.2	1.7	2.6	4
Temperature Range:	-55°C to +125°C				
Reliability:	0.2% per 100 hours at 85°C, V <sub>R</sub> , 0.1Ω/V series impedance, 60% confidence level				



# OxiCap™ NOM Low ESR Multianodes

## Niobium Oxide Capacitor

### CAPACITANCE AND RATED VOLTAGE RANGE (LETTER DENOTES CASE SIZE)

Capacitance		Rated Voltage DC (V <sub>R</sub> ) to 85°C / 0.66 DC to 105°C / 0.5 DC to 125°C				
Cap. (µF)	Code	1.8V (x)	2.5V (e)	4.0V (G)	6.3V (J)	10V (A)
150	157					E(40)
220	227				E(40)	
330	337			E(35)		
470	477		E(30)			
680	687	E(23)				
1000	108					

Developmental Ratings - subject to change



LEAD-FREE

LEAD-FREE COMPATIBLE  
COMPONENT



HALOGEN-FREE COMPOUNDS

ENVIRONMENTAL FRIENDLY  
COMPONENT



NON-BURN  
NON-SMOKE

### RATINGS & PART NUMBER REFERENCE

AVX Part No.	Case Size	Capacitance (µF)	Rated Voltage(V)	DCL (µA)	DF %	ESR Max. (mΩ)	100kHz Ripple Current Ratings (A)			100kHz Ripple Voltage Ratings (V)		
							25°C	85°C	125°C	25°C	85°C	125°C
<b>1.8 Volt @ 85°C (1.2 Volt @ 105°C / 0.9V @ 125°C)</b>												
NOME687M001#0023	E	680	1.8	24.5	6	23	3.753	3.378	1.501	0.086	0.078	0.035
<b>2.5 Volt @ 85°C (1.7 Volt @ 105°C / 1.3V @ 125°C)</b>												
NOME477M002#0030	E	470	2.5	23.5	10	30	3.286	2.958	1.315	0.099	0.089	0.039
<b>4 Volt @ 85°C (2.7 Volt @ 105°C / 2V @ 125°C)</b>												
NOME337M004#0035	E	330	4	26.4	8	35	3.043	2.738	1.217	0.106	0.096	0.043
<b>6.3 Volt @ 85°C (4 Volt @ 105°C / 3V @ 125°C)</b>												
NOME227M006#0040	E	220	6.3	26.4	12	40	2.846	2.561	1.138	0.114	0.102	0.046

All technical data relates to an ambient temperature of +25°C. Capacitance and DF are measured at 120Hz, 0.5RMS with DC bias of 2.2V. DCL is measured at rated voltage after 5 minutes.

NOTE: AVX reserves the rights to supply higher voltage rating in the same case size, to the same reliability standards.

# Section 3: Introduction



## Foreword

AVX offers a broad line of solid Tantalum capacitors in a wide range of sizes, styles, and ratings to meet any design needs. This catalog combines into one source AVX's leaded tantalum capacitor information from its worldwide tantalum operations.

The TAP is rated for use from -55°C to +85°C at rated voltage and up to +125°C with voltage derating. There are three preferred wire forms to choose from which are available on tape and reel, and in bulk for hand insertion.

Four sizes of molded axials, the TAR series, are also available. The TAR is fully marked and available on tape and reel for high speed insertion. The TAA is a hermetically sealed series also with four case sizes available.

AVX has a complete tantalum applications service available for use by all our customers. With the capability to prototype and mass produce solid tantalum capacitors in special configurations, almost any design need can be fulfilled. And if the customer requirements are outside our standard testing, AVX will work with you to define and implement a test or screening plan.

AVX is determined to become the world leader in tantalum capacitor technology and has made, and is continuing to make, significant investments in equipment and research to reach that end. We believe that the investment has paid off with the devices shown on the following pages.

# Dipped Radial Capacitors

## SOLID TANTALUM RESIN DIPPED SERIES TAP

The TAP resin dipped series of miniature tantalum capacitors is available for individual needs in both commercial and professional applications. From computers to automotive to industrial, AVX has a dipped radial for almost any application.

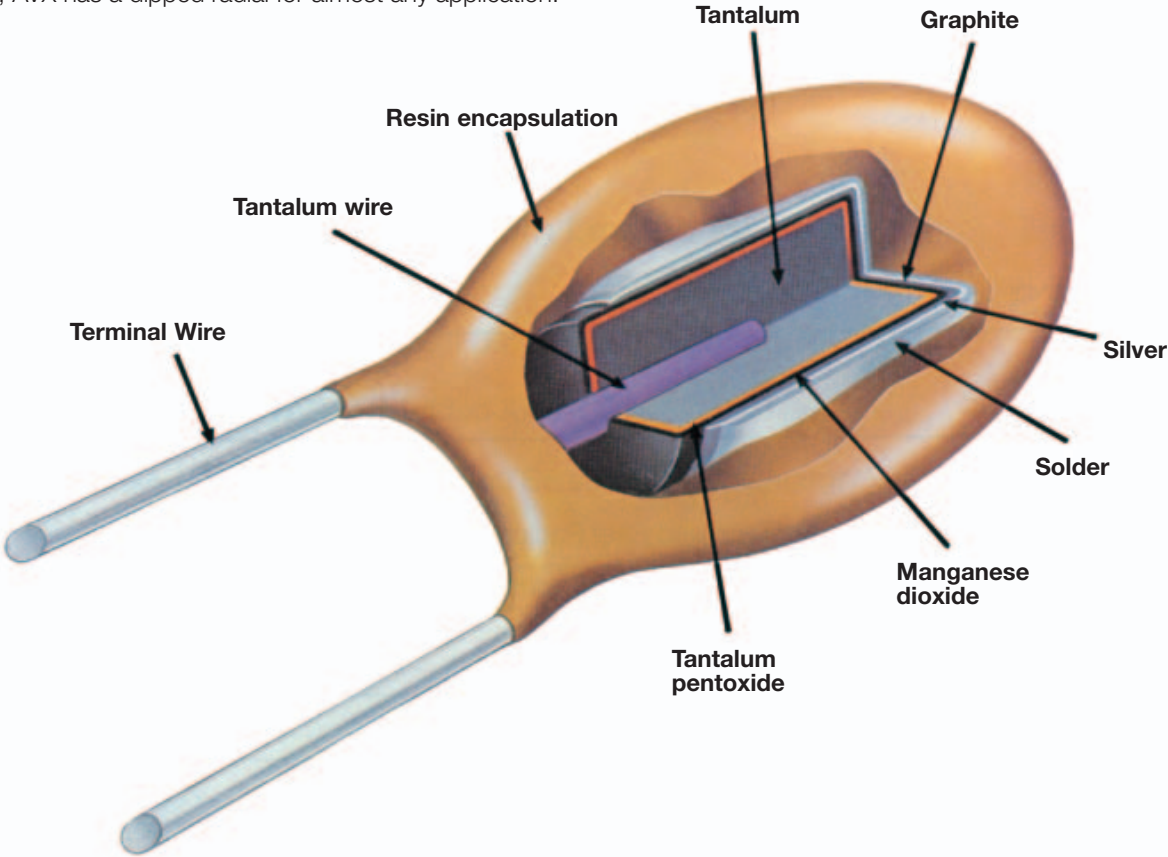

# Dipped Radial Capacitors



## Wire Form Outline

### SOLID TANTALUM RESIN DIPPED TAP

#### Preferred Wire Forms

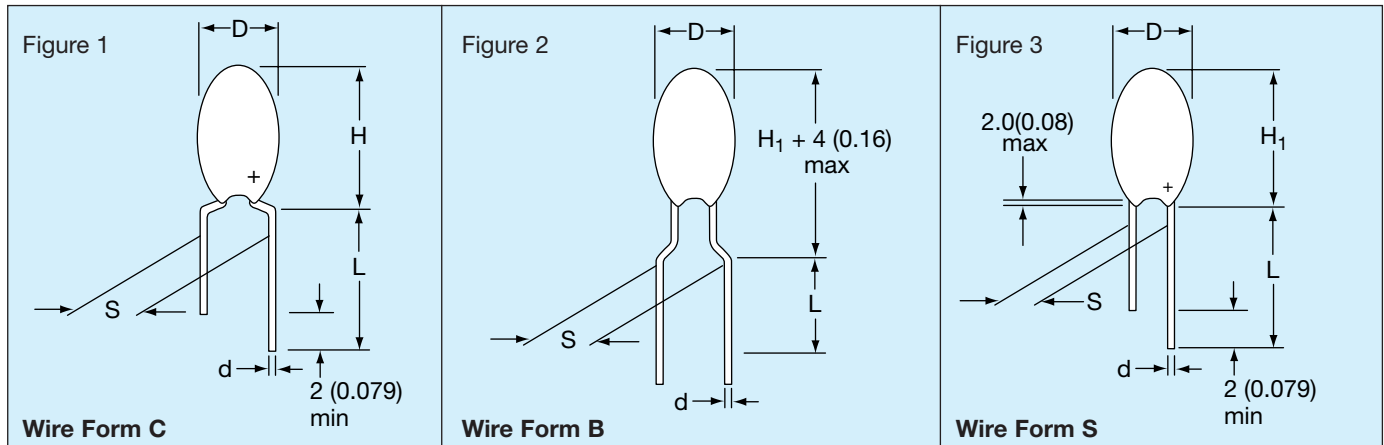

#### Non-Preferred Wire Forms (Not recommended for new designs)

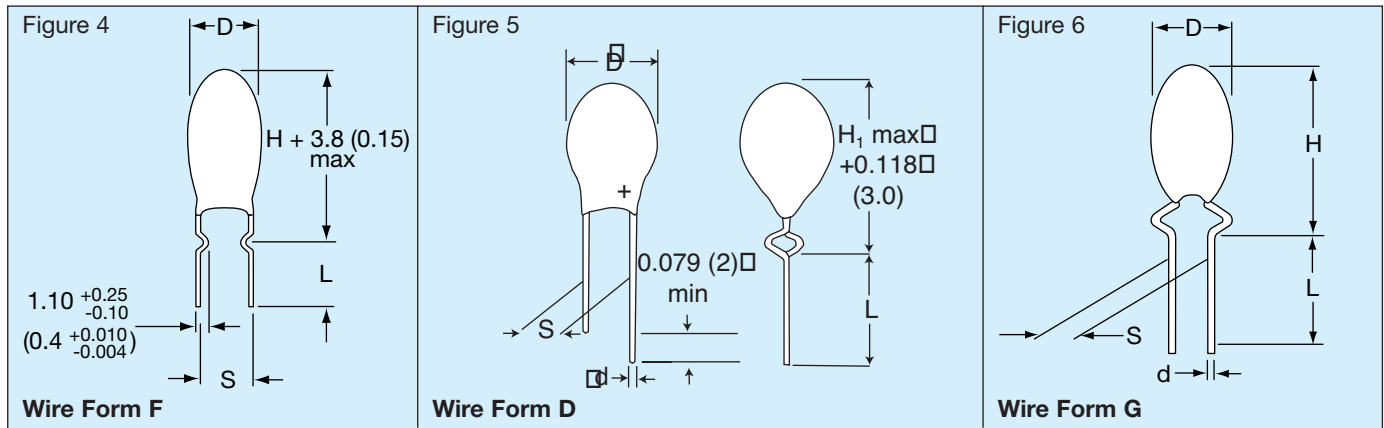

### DIMENSIONS

Wire Form	Figure	Case Size	L (see note 1)	S	d	Packaging Suffixes Available*
-----------	--------	-----------	----------------	---	---	-------------------------------

#### Preferred Wire Forms

C	Figure 1	A - R*	16.0±4.00 (0.630±0.160)	5.00±1.00 (0.200±0.040)	0.50±0.05 (0.020±0.002)	CCS Bulk CRW Tape/Reel CRS Tape/Ammo
B	Figure 2	A - J*	16.0±4.00 (0.630±0.160)	5.00±1.00 (0.200±0.040)	0.50±0.05 (0.020±0.002)	BRW Tape/Reel BRS Tape/Ammo
S	Figure 3	A - J*	16.0±4.00 (0.630±0.160)	2.50±0.50 (0.100±0.020)	0.50±0.05 (0.020±0.002)	SCS Bulk SRW Tape/Reel SRS Tape/Ammo

#### Non-Preferred Wire Forms (Not recommended for new designs)

F	Figure 4	A - R	3.90±0.75 (0.155±0.030)	5.00±0.50 (0.200±0.020)	0.50±0.05 (0.020±0.002)	FCS Bulk
D	Figure 5	A - H*	16.0±4.00 (0.630±0.160)	2.50±0.75 (0.100±0.020)	0.50±0.05 (0.020±0.002)	DCS Bulk DTW Tape/Reel DTS Tape/Ammo
G	Figure 6	A - J	16.0±4.00 (0.630±0.160)	3.18±0.50 (0.125±0.020)	0.50±0.05 (0.020±0.002)	GSB Bulk
H	Similar to Figure 1	A - R	16.0±4.00 (0.630±0.160)	6.35±1.00 (0.250±0.040)	0.50±0.05 (0.020±0.002)	HSB Bulk

Notes: (1) Lead lengths can be supplied to tolerances other than those above and should be specified in the ordering information.

(2) For D, H, and H<sub>1</sub> dimensions, refer to individual product on following pages.

\* For case size availability in tape and reel, please refer to pages 91-92.





# Dipped Radial Capacitors



## TAP Series

### SOLID TANTALUM RESIN DIPPED CAPACITORS

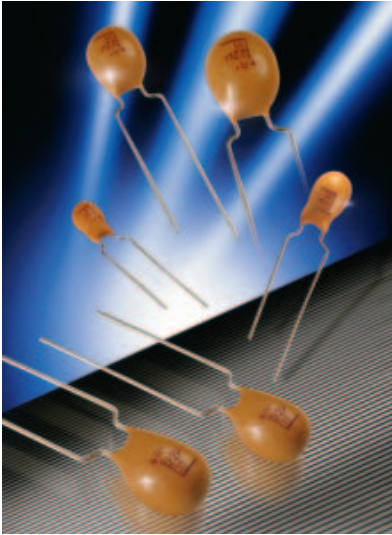

TAP is a professional grade device manufactured with a flame retardant coating and featuring low leakage current and impedance, very small physical sizes and exceptional temperature stability. It is designed and conditioned to operate to +125°C (see page 123 for voltage derating above 85°C) and is available loose or taped and reeled for auto insertion. The 15 case sizes with wide capacitance and working voltage ranges means the TAP can accommodate almost any application.

### MAXIMUM CASE DIMENSIONS: millimeters (inches)

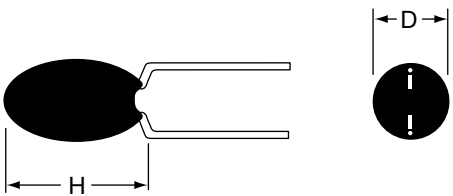

Wire Case	C, F, G, H H	B, S, D *H <sub>1</sub>	D
A	8.50 (0.330)	7.00 (0.280)	4.50 (0.180)
B	9.00 (0.350)	7.50 (0.300)	4.50 (0.180)
C	10.0 (0.390)	8.50 (0.330)	5.00 (0.200)
D	10.5 (0.410)	9.00 (0.350)	5.00 (0.200)
E	10.5 (0.410)	9.00 (0.350)	5.50 (0.220)
F	11.5 (0.450)	10.0 (0.390)	6.00 (0.240)
G	11.5 (0.450)	10.0 (0.390)	6.50 (0.260)
H	12.0 (0.470)	10.5 (0.410)	7.00 (0.280)
J	13.0 (0.510)	11.5 (0.450)	8.00 (0.310)
K	14.0 (0.550)	12.5 (0.490)	8.50 (0.330)
L	14.0 (0.550)	12.5 (0.490)	9.00 (0.350)
M	14.5 (0.570)	13.0 (0.510)	9.00 (0.350)
N	16.0 (0.630)		9.00 (0.350)
P	17.0 (0.670)		10.0 (0.390)
R	18.5 (0.730)		10.0 (0.390)

### HOW TO ORDER

**TAP**

Type

**475**

**Capacitance Code**  
pF code: 1st two digits represent significant figures, 3rd digit represents multiplier (number of zeros to follow)

**M**

**Capacitance Tolerance**  
K = ±10%  
M = ±20%  
(For J = ±5% tolerance, please consult factory)

**035**

Rated DC Voltage

**SCS**

Suffix indicating wire form and packaging  
(see page 87)

# Dipped Radial Capacitors



## TAP Series

### TECHNICAL SPECIFICATIONS

Technical Data:		All technical data relate to an ambient temperature of +25°C							
Capacitance Range:		0.1μF to 330μF							
Capacitance Tolerance:		±20%; ±10% (±5% consult your AVX representative for details)							
Rated Voltage DC (V <sub>R</sub> )	≤+85°C:	6.3	10	16	20	25	35	50	
Category Voltage (V <sub>C</sub> )	≤+125°C:	4	6.3	10	13	16	23	33	
Surge Voltage (V <sub>S</sub> )	≤+85°C:	8	13	20	26	33	46	65	
	≤+125°C:	5	9	12	16	21	28	40	
Temperature Range:		-55°C to +125°C							
Environmental Classification:		55/125/56 (IEC 68-2)							
Dissipation Factor:		≤0.04 for C <sub>R</sub> 0.1-1.5μF ≤0.06 for C <sub>R</sub> 2.2-6.8μF ≤0.08 for C <sub>R</sub> 10-68μF ≤0.10 for C <sub>R</sub> 100-330μF							
Reliability:		1% per 1000 hrs. at 85°C with 0.1Ω/V series impedance, 60% confidence level.							
Qualification:		CECC 30201 - 032							

Capacitance Range (letter denotes case size)								
Capacitance		Rated voltage DC (V <sub>R</sub> )						
μF	Code	6.3V	10V	16V	20V	25V	35V	50V
0.1	104						A	A
0.15	154						A	A
0.22	224						A	A
0.33	334						A	A
0.47	474						A	A
0.68	684						A	B
1.0	105				A	A	A	C
1.5	155			A	A	A	A	D
2.2	225		A	A	A	A	B	E
3.3	335	A	A	A	B	B	C	F
4.7	475	A	A	B	C	C	E	G
6.8	685	A	B	C	D	D	F	H
10	106	B	C	D	E	E	F	J
15	156	C	D	E	F	F	H	K
22	226	D	E	F	H	H	K	L
33	336	E	F	F	J	J	M	
47	476	F	G	J	K	M	N	
68	686	G	H	L	N	N		
100	107	H	K	N	N			
150	157	K	N	N				
220	227	M	P	R				
330	337	P	R					

Values outside this standard range may be available on request.  
 AVX reserves the right to supply capacitors to a higher voltage rating, in the same case size, than that ordered.

### MARKING

Polarity, capacitance, rated DC voltage, and an "A" (AVX logo) are laser marked on the capacitor body which is made of flame retardant gold epoxy resin with a limiting oxygen index in excess of 30 (ASTM-D-2863).

- Polarity
- Capacitance
- Voltage
- AVX logo
- Tolerance code:
  - ±20% = Standard (no marking)
  - ±10% = "K" on reverse side of unit
  - ±5% = "J" on reverse side of unit

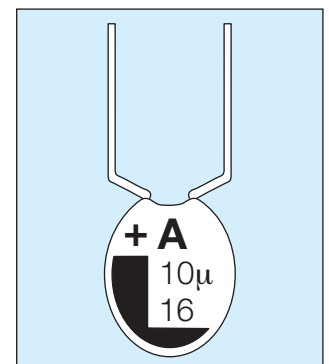

# Dipped Radial Capacitors



## TAP Series

### RATINGS AND PART NUMBER REFERENCE

AVX Part No.	Case Size	Capacitance $\mu\text{F}$	DCL ( $\mu\text{A}$ ) Max.	DF % Max.	ESR Max. ( $\Omega$ ) @ 100 kHz
<b>6.3 volt @ 85°C (4 volt @ 125°C)</b>					
TAP 335(+006)	A	3.3	0.5	6	13.0
TAP 475(+006)	A	4.7	0.5	6	10.0
TAP 685(+006)	A	6.8	0.5	6	8.0
TAP 106(+006)	B	10	0.5	8	6.0
TAP 156(+006)	C	15	0.8	8	5.0
TAP 226(+006)	D	22	1.1	8	3.7
TAP 336(+006)	E	33	1.7	8	3.0
TAP 476(+006)	F	47	2.4	8	2.0
TAP 686(+006)	G	68	3.4	8	1.8
TAP 107(+006)	H	100	5.0	10	1.6
TAP 157(+006)	K	150	7.6	10	0.9
TAP 227(+006)	M	220	11.0	10	0.9
TAP 337(+006)	P	330	16.6	10	0.7
<b>10 volt @ 85°C (6.3 volt @ 125°C)</b>					
TAP 225(+010)	A	2.2	0.5	6	13.0
TAP 335(+010)	A	3.3	0.5	6	10.0
TAP 475(+010)	A	4.7	0.5	6	8.0
TAP 685(+010)	B	6.8	0.5	6	6.0
TAP 106(+010)	C	10	0.8	8	5.0
TAP 156(+010)	D	15	1.2	8	3.7
TAP 226(+010)	E	22	1.7	8	2.7
TAP 336(+010)	F	33	2.6	8	2.1
TAP 476(+010)	G	47	3.7	8	1.7
TAP 686(+010)	H	68	5.4	8	1.3
TAP 107(+010)	K	100	8.0	10	1.0
TAP 157(+010)	N	150	12.0	10	0.8
TAP 227(+010)	P	220	17.6	10	0.6
TAP 337(+010)	R	330	20.0	10	0.5
<b>16 volt @ 85°C (10 volt @ 125°C)</b>					
TAP 155(+016)	A	1.5	0.5	4	10.0
TAP 225(+016)	A	2.2	0.5	6	8.0
TAP 335(+016)	A	3.3	0.5	6	6.0
TAP 475(+016)	B	4.7	0.6	6	5.0
TAP 685(+016)	C	6.8	0.8	6	4.0
TAP 106(+016)	D	10	1.2	8	3.2
TAP 156(+016)	E	15	1.9	8	2.5
TAP 226(+016)	F	22	2.8	8	2.0
TAP 336(+016)	F	33	4.2	8	1.6
TAP 476(+016)	J	47	6.0	8	1.3
TAP 686(+016)	L	68	8.7	8	1.0
TAP 107(+016)	N	100	12.8	10	0.8
TAP 157(+016)	N	150	19.2	10	0.6
TAP 227(+016)	R	220	20.0	10	0.5
<b>20 volt @ 85°C (13 volt @ 125°C)</b>					
TAP 105(+020)	A	1.0	0.5	4	10.0
TAP 155(+020)	A	1.5	0.5	4	9.0
TAP 225(+020)	A	2.2	0.5	6	7.0
TAP 335(+020)	B	3.3	0.5	6	5.5
TAP 475(+020)	C	4.7	0.7	6	4.5
TAP 685(+020)	D	6.8	1.0	6	3.6
TAP 106(+020)	E	10	1.6	8	2.9
TAP 156(+020)	F	15	2.4	8	2.3
TAP 226(+020)	H	22	3.5	8	1.8

AVX Part No.	Case Size	Capacitance $\mu\text{F}$	DCL ( $\mu\text{A}$ ) Max.	DF % Max.	ESR Max. ( $\Omega$ ) @ 100 kHz
<b>20 volt @ 85°C (13 volt @ 125°C) continued</b>					
TAP 336(+020)	J	33	5.2	8	1.4
TAP 476(+020)	K	47	7.5	8	1.2
TAP 686(+020)	N	68	10.8	8	0.9
TAP 107(+020)	N	100	16.0	10	0.6
<b>25 volt @ 85°C (16 volt @ 125°C)</b>					
TAP 105(+025)	A	1.0	0.5	4	10.0
TAP 155(+025)	A	1.5	0.5	4	8.0
TAP 225(+025)	A	2.2	0.5	6	6.0
TAP 335(+025)	B	3.3	0.6	6	5.0
TAP 475(+025)	C	4.7	0.9	6	4.0
TAP 685(+025)	D	6.8	1.3	6	3.1
TAP 106(+025)	E	10	2.0	8	2.5
TAP 156(+025)	F	15	3.0	8	2.0
TAP 226(+025)	H	22	4.4	8	1.5
TAP 336(+025)	J	33	6.6	8	1.2
TAP 476(+025)	M	47	9.4	8	1.0
TAP 686(+025)	N	68	13.6	8	0.8
<b>35 volt @ 85°C (23 volt @ 125°C)</b>					
TAP 104(+035)	A	0.1	0.5	4	26.0
TAP 154(+035)	A	0.15	0.5	4	21.0
TAP 224(+035)	A	0.22	0.5	4	17.0
TAP 334(+035)	A	0.33	0.5	4	15.0
TAP 474(+035)	A	0.47	0.5	4	13.0
TAP 684(+035)	A	0.68	0.5	4	10.0
TAP 105(+035)	A	1.0	0.5	4	8.0
TAP 155(+035)	A	1.5	0.5	4	6.0
TAP 225(+035)	B	2.2	0.6	6	5.0
TAP 335(+035)	C	3.3	0.9	6	4.0
TAP 475(+035)	E	4.7	1.3	6	3.0
TAP 685(+035)	F	6.8	1.9	6	2.5
TAP 106(+035)	F	10	2.8	8	2.0
TAP 156(+035)	H	15	4.2	8	1.6
TAP 226(+035)	K	22	6.1	8	1.3
TAP 336(+035)	M	33	9.2	8	1.0
TAP 476(+035)	N	47	10.0	8	0.8
<b>50 volt @ 85°C (33 volt @ 125°C)</b>					
TAP 104(+050)	A	0.1	0.5	4	26.0
TAP 154(+050)	A	0.15	0.5	4	21.0
TAP 224(+050)	A	0.22	0.5	4	17.0
TAP 334(+050)	A	0.33	0.5	4	15.0
TAP 474(+050)	A	0.47	0.5	4	13.0
TAP 684(+050)	B	0.68	0.5	4	10.0
TAP 105(+050)	C	1.0	0.5	4	8.0
TAP 155(+050)	D	1.5	0.6	4	6.0
TAP 225(+050)	E	2.2	0.8	6	3.5
TAP 335(+050)	F	3.3	1.3	6	3.0
TAP 475(+050)	G	4.7	1.8	6	2.5
TAP 685(+050)	H	6.8	2.7	6	2.0
TAP 106(+050)	J	10	4.0	8	1.6
TAP 156(+050)	K	15	6.0	8	1.2
TAP 226(+050)	L	22	8.8	8	1.0

(\*) Insert capacitance tolerance code; M for  $\pm 20\%$ , K for  $\pm 10\%$  and J for  $\pm 5\%$

NOTE: Voltage ratings are minimum values. AVX reserves the right to supply higher voltage ratings in the same case size.

### SOLID TANTALUM RESIN DIPPED TAP

#### TAPE AND REEL PACKAGING FOR AUTOMATIC COMPONENT INSERTION

TAP types are all offered on radial tape, in reel or 'ammo' pack format for use on high speed radial automatic insertion equipment, or preforming machines.

The tape format is compatible with EIA 468A standard for component taping set out by major manufacturers of radial automatic insertion equipment.

**TAP** – available in three formats. See page 92 for dimensions.

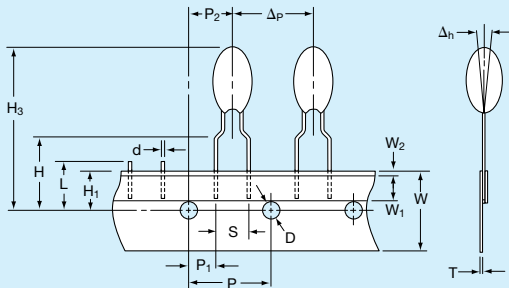

'B' wires for normal automatic insertion on 5mm pitch.

BRW suffix for reel  
BRS suffix for 'ammo' pack  
Available in case sizes A - J

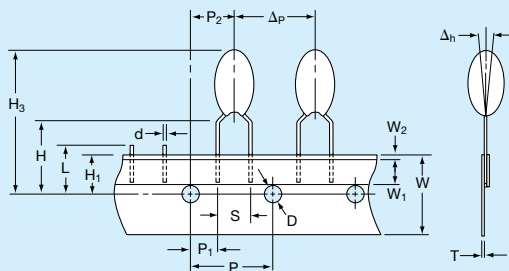

'C' wires for preforming.

CRW suffix for reel  
CRS suffix for 'ammo' pack  
Available in case sizes A - R

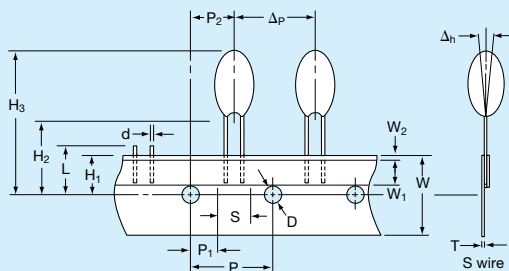

'S' and 'D' wire for special applications, automatic insertion on 2.5mm pitch.

SRW, DTW suffix for reel  
SRS, DTS suffix for 'ammo' pack  
Available in case sizes A - J

# Dipped Radial Capacitors



## Tape and Reel Packaging

### SOLID TANTALUM RESIN DIPPED TAP

#### DIMENSIONS:

Description	Code	Dimension millimeters (inches)
Feed hole pitch	P	12.7 ± 0.30 (0.500 ± 0.010)
Hole center to lead	P <sub>1</sub>	3.85 ± 0.70 (0.150 ± 0.030) to be measured at bottom of clench
		5.05 ± 1.00 (0.200 ± 0.040) for S wire
Hole center to component center	P <sub>2</sub>	6.35 ± 0.40 (0.250 ± 0.020)
Change in pitch	Δp	± 1.00 (± 0.040)
Lead diameter	d	0.50 ± 0.05 (0.020 ± 0.003)
Lead spacing	S	See wire form table
Component alignment	Δh	0 ± 2.00 (0 ± 0.080)
Feed hole diameter	D	4.00 ± 0.20 (0.150 ± 0.008)
Tape width	W	18.0 + 1.00 (0.700 + 0.040) - 0.50 - 0.020)
Hold down tape width	W <sub>1</sub>	6.00 (0.240) min.
Hold down tape position	W <sub>2</sub>	1.00 (0.040) max.
Lead wire clench height	H	16.0 ± 0.50 (0.630 ± 0.020)
		19.0 ± 1.00 (0.750 ± 0.040) on request
Hole position	H <sub>1</sub>	9.00 ± 0.50 (0.350 ± 0.020)
Base of component height	H <sub>2</sub>	18.0 (0.700) min. (S wire only)
Component height	H <sub>3</sub>	32.25 (1.300) max.
Length of snipped lead	L	11.0 (0.430) max.
Total tape thickness	T	0.70 ± 0.20 (0.030 ± 0.001)
		Carrying card 0.50 ± 0.10 (0.020 ± 0.005)

#### REEL CONFIGURATION AND DIMENSIONS:

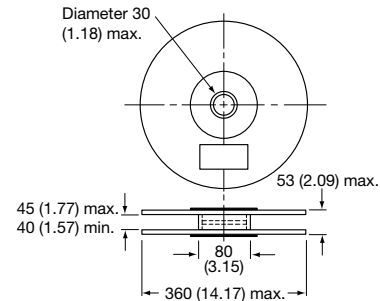

Manufactured from cardboard with plastic hub.

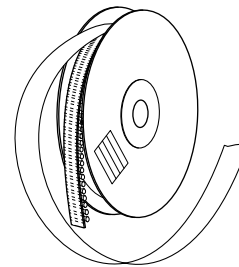

Holding tape outside. Positive terminal leading.

### PACKAGING QUANTITIES

#### For Reels

Style	Case size	No. of pieces
TAP	A	1500
	B, C, D	1250
	E, F	1000
	G, H, J	750
	K, L, M, N, P, R	500

#### For 'Ammo' pack

Style	Case size	No. of pieces
TAP	A, B, C, D	3000
	E, F, G	2500
	H, J	2000
	K, L, M, N, P, R	1000

#### For bulk products

Style	Case size	No. of pieces
TAP	A to H	1000
	J to L	500
	M to R	100

### AMMO PACK DIMENSIONS

millimeters (inches) max.

Height 360 (14.17), width 360 (14.17), thickness 60 (2.36)

### GENERAL NOTES

Resin dipped tantalum capacitors are only available taped in the range of case sizes and in the modular quantities by case size as indicated.

Packaging quantities on tape may vary by ±1%.

# Molded Axial Capacitors



## TAR Series

### SOLID TANTALUM MOLDED AXIAL LEADED CAPACITORS

**TAR:** Designed for use in miniature and subminiature circuit applications.

1. Precision molded and taped and reeled for use in high speed automatic insertion applications.
2. Suitable for decoupling, blocking, by-passing and filtering in computers, data processing, communications and other equipment.
3. Available in four case sizes.
4. Tapered nose identifies positive polarity.
5. Capacitance, tolerance, rated voltage and polarity are marked onto the capacitor body.
6. See page 99 for packaging quantities.



### CASE DIMENSIONS: millimeters (inches)

Case Size	L ±0.25 (0.010)	D <sub>1</sub> ±0.25 (0.010)	d ±0.05 (0.002)	Typical Weight g
Q	6.35 (0.250)	2.16 (0.085)	0.50 (0.020)	0.20
R	7.40 (0.290)	2.50 (0.100)	0.50 (0.020)	0.25
S	8.60 (0.340)	4.30 (0.170)	0.50 (0.020)	0.52
W	10.4 (0.410)	4.30 (0.170)	0.50 (0.020)	0.53

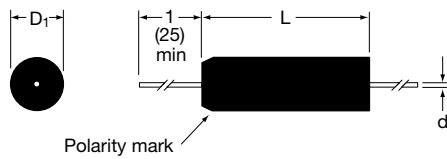

### HOW TO ORDER

**TAR**

Type

**R**

Case Size

**335**

Capacitance Code  
pF code: 1st two digits  
represent significant figures,  
3rd digit represents multiplier  
(number of zeros to follow)

**M**

Capacitance Tolerance  
K = ±10%  
M = ±20%

**015**

Rated DC Voltage

\*Not recommended for new designs



# Molded Axial Capacitors



## TAR Series

### TECHNICAL SPECIFICATIONS

Technical Data:		All technical data relate to an ambient temperature of +25°C							
Capacitance Range:		0.1μF to 68μF							
Capacitance Tolerance:		±20%; ±10%							
Rated Voltage DC (V <sub>R</sub> )	≅+85°C:	4	6.3	10	15	20	25	35	50
Category Voltage (V <sub>C</sub> )	≅+125°C:	2.7	4	6.3	10	13	17	23	33
Surge Voltage (V <sub>S</sub> )	≅+85°C:	5.2	8	13	20	26	33	46	65
	≅+125°C:	3.5	5	9	12	16	21	28	40
Temperature Range:		-55°C to +125°C							
Environmental Classification:		55/125/56 (IEC 68-2)							
Dissipation Factor:		See part number table							

Capacitance Range (letter denotes case size)								
Capacitance μF	Rated voltage DC (V <sub>R</sub> )							
	4V	6.3V	10V	15V	20V	25V	35V	50V
0.1							Q	Q
0.15							Q	Q
0.22							Q	Q
0.33						Q	Q	R
0.47						Q	R	R
0.68							R	R
1.0					Q	Q	R	R
1.5				Q	Q	R	R	S
2.2			Q	Q	R	R	S	S
3.3		Q	Q	R	R	R	S	W
4.7	Q	Q	R	R	R	S	S	W
6.8	Q	R	R	R	S	S	W	
10	R	R	R	S	S	S	W	
15	R	R	S	S	W	W		
22	R	S	S	W	W			
33	S	S	W	W				
47	S	W	W					
68	W	W						

Values outside this standard range may be available on request without appropriate release or qualification.

AVX reserves the right to supply capacitors to a tighter specification than that ordered.

### MARKING

- Polarity
- Capacitance
- Date code
- Tolerance
- Voltage

# Molded Axial Capacitors



## TAR Series

### RATINGS AND PART NUMBER REFERENCE

AVX Part No.	Case Size	Capacitance $\mu\text{F}$	DCL ( $\mu\text{A}$ ) Max.	DF % Max.	ESR Max. ( $\Omega$ ) @ 100 kHz
<b>4 volt @ 85°C (2.7 volt @ 125°C)</b>					
TARQ475(+)*004	Q	4.7	0.5	8	12
TARQ685(+)*004	Q	6.8	0.5	8	10
TARR106(+)*004	R	10	0.5	8	10
TARR156(+)*004	R	15	0.5	8	8.0
TARR226(+)*004	R	22	0.7	8	6.0
TARS336(+)*004	S	33	1.1	8	5.0
TARS476(+)*004	S	47	1.5	8	3.5
TARW686(+)*004	W	68	2.2	8	2.5
<b>6.3 volt @ 85°C (4 volt @ 125°C)</b>					
TARQ335(+)*006	Q	3.3	0.5	4	14
TARQ475(+)*006	Q	4.7	0.5	4	10
TARR685(+)*006	R	6.8	0.5	6	8.0
TARR106(+)*006	R	10	0.5	6	6.0
TARR156(+)*006	R	15	0.7	6	5.0
TARS226(+)*006	S	22	1.1	6	3.7
TARS336(+)*006	S	33	1.5	6	3.0
TARW476(+)*006	W	47	2.3	6	2.0
TARW686(+)*006	W	68	3.3	6	1.8
<b>10 volt @ 85°C (7 volt @ 125°C)</b>					
TARQ225(+)*010	Q	2.2	0.5	4	14
TARQ335(+)*010	Q	3.3	0.5	4	10
TARR475(+)*010	R	4.7	0.5	4	8.0
TARR685(+)*010	R	6.8	0.5	6	6.0
TARR106(+)*010	R	10	0.8	6	5.0
TARS156(+)*010	S	15	1.2	6	3.7
TARS226(+)*010	S	22	1.5	6	2.7
TARW336(+)*010	W	33	2.6	6	2.1
TARW476(+)*010	W	47	3.8	6	1.7
<b>15 volt @ 85°C (10 volt @ 125°C)</b>					
TARQ155(+)*015	Q	1.5	0.5	4	14
TARQ225(+)*015	Q	2.2	0.5	4	8.0
TARR335(+)*015	R	3.3	0.5	4	6.0
TARR475(+)*015	R	4.7	0.6	4	5.0
TARR685(+)*015	R	6.8	0.8	6	4.0
TARS106(+)*015	S	10	1.2	6	3.2
TARS156(+)*015	S	15	1.5	6	2.5
TARW226(+)*015	W	22	2.6	6	2.0
TARW336(+)*015	W	33	4.0	6	1.6
<b>20 volt @ 85°C (13 volt @ 125°C)</b>					
TARQ105(+)*020	Q	1.0	0.5	4	18
TARQ155(+)*020	Q	1.5	0.5	4	12
TARR225(+)*020	R	2.2	0.5	4	7.0
TARR335(+)*020	R	3.3	0.5	4	5.5
TARR475(+)*020	R	4.7	0.8	4	4.5
TARS685(+)*020	S	6.8	1.1	6	3.7
TARS106(+)*020	S	10	1.6	6	2.8
TARW156(+)*020	W	15	2.4	6	2.3
TARW226(+)*020	W	22	3.5	6	1.9

AVX Part No.	Case Size	Capacitance $\mu\text{F}$	DCL ( $\mu\text{A}$ ) Max.	DF % Max.	ESR Max. ( $\Omega$ ) @ 100 kHz
<b>25 volt @ 85°C (17 volt @ 125°C)</b>					
TARQ474(+)*025	Q	0.47	0.5	3	20
TARQ684(+)*025	Q	0.68	0.5	3	16
TARQ105(+)*025	Q	1.0	0.5	3	12
TARR155(+)*025	R	1.5	0.5	3	8.0
TARR225(+)*025	R	2.2	0.5	3	6.0
TARR335(+)*025	R	3.3	0.7	3	5.0
TARS475(+)*025	S	4.7	0.9	4	4.0
TARS685(+)*025	S	6.8	1.4	4	3.1
TARS106(+)*025	S	10	1.5	4	2.5
TARW156(+)*025	W	15	3.0	4	2.0
<b>35 volt @ 85°C (23 volt @ 125°C)</b>					
TARQ104(+)*035	Q	0.1	0.5	3	26
TARQ154(+)*035	Q	0.15	0.5	3	21
TARQ224(+)*035	Q	0.22	0.5	3	17
TARQ334(+)*035	Q	0.33	0.5	3	15
TARQ474(+)*035	Q	0.47	0.5	3	13
TARQ684(+)*035	R	0.68	0.5	3	10
TARR105(+)*035	R	1.0	0.5	3	8.0
TARR155(+)*035	R	1.5	0.5	3	6.0
TARS225(+)*035	S	2.2	0.6	3	5.0
TARS335(+)*035	S	3.3	0.9	4	4.0
TARS475(+)*035	S	4.7	1.3	4	3.0
TARW685(+)*035	W	6.8	1.9	4	2.5
TARW106(+)*035	W	10	2.8	4	2.0
<b>50 volt @ 85°C (33 volt @ 125°C)</b>					
TARQ104(+)*050	Q	0.1	0.5	3	26
TARQ154(+)*050	Q	0.15	0.5	3	21
TARQ224(+)*050	Q	0.22	0.5	3	17
TARR334(+)*050	R	0.33	0.5	3	15
TARR474(+)*050	R	0.47	0.5	3	13
TARR684(+)*050	R	0.68	0.5	3	10
TARR105(+)*050	R	1.0	0.5	3	8.0
TARS155(+)*050	S	1.5	0.6	4	5.0
TARS225(+)*050	S	2.2	0.9	4	3.5
TARW335(+)*050	W	3.3	1.3	4	3.0
TARW475(+)*050	W	4.7	1.9	4	2.5

(\*) Insert capacitance tolerance code; M for  $\pm 20\%$  and K for  $\pm 10\%$

NOTE: Voltage ratings are minimum values. AVX reserves the right to supply higher voltage ratings in the same case size.



# Hermetic Axial Capacitors



## TAA Series

### SOLID TANTALUM HERMETICALLY SEALED AXIAL LEADED CAPACITORS



**TAA:** Fully hermetically sealed, of rugged construction and high reliability for use in military and professional equipment.

1. Extremely low leakage current.
2. Excellent capacitance to size ratio.
3. Available taped and reeled for automatic insertion.
4. Marked with AVX logo, capacitor type, capacitance, capacitance tolerance, rated voltage, polarity indication and date of manufacture.
5. Approved to CECC 30-201-801 and IECQ QC300 201 GB0002 supplied conforming to the limits of MIL-C-39003 style CSR, CTS 13 and CTS 32.

### CASE DIMENSIONS: millimeters (inches)

Case Size	L <sub>1</sub> max.	L <sub>2</sub> max.	D max.	Lead Length min.	d nom.	Weight max. g
A	7.20 (0.280)	10.7 (0.420)	3.60 (0.140)	28.0 (1.100)	0.50	0.7
B	12.0 (0.470)	15.5 (0.610)	4.90 (0.190)	28.0 (1.100)	0.50	1.3
C	17.3 (0.680)	20.9 (0.820)	7.50 (0.290)	23.0 (0.900)	0.60	4.7
D	19.9 (0.780)	23.4 (0.920)	9.00 (0.350)	22.0 (0.800)	0.60	7.4

Note: The tabulated dimensions are for non-insulated capacitors. Insulated capacitors are standard, dimension L<sub>1</sub> will increase by 0.8mm maximum, and dimension D by 0.2mm maximum.

### HOW TO ORDER

**TAA**

Type

**A**

Case Size

**105**

Capacitance Code  
pF code:  
1st two digits represent significant figures,  
3rd digit represents multiplier (number of zeros to follow)

**M**

Capacitance Tolerance  
K = ±10%  
M = ±20%

**035**

Rated DC Voltage

**G**

TAA Packaging Suffixes  
(see page 99)

\*Not recommended for new designs

# Hermetic Axial Capacitors



## TAA Series

### TECHNICAL SPECIFICATIONS

Construction:	Hermetically sealed; axial terminations							Temperature Range:	-55°C to +125°C
Capacitance Range:	0.1µF to 330µF							Environmental Classification:	55/125/56 (IEC 68-2)
Capacitance Tolerance:	±20%; ±10%							Dissipation Factor: (tan δ)	≤0.04 for C=0.1 to 4.7µF
Measuring Conditions:	120 Hz, 20°C								≤0.06 for C= 6.8 to 100µF
Rated Voltage VDC	≤+85°C:	6.3	10	16	20	25	35	50	≤0.08 for C= 150 to 330µF
Category Voltage VDC	≤+125°C:	4	6.3	10	13	17	23	33	Approvals:
Surge Voltage VDC	≤+85°C:	8	13	20	26	33	46	65	BS CECC 30 201-801
	≤+125°C:	5	9	12	16	21	28	40	

Capacitance Range (letter denotes case size)								
Capacitance µF	Cap Code	Rated voltage DC						
		6.3V	10V	16V	20V	25V	35V	50V
0.1	104						A	A
0.15	154						A	A
0.22	224						A	A
0.33	334						A	A
0.47	474						A	A
0.68	684					A	A	A
1.0	105						A	A
1.5	155				A	A	B	B
2.2	225	A			A		B	B
3.3	335	A		A			B	B
4.7	475	A	A		B	B	B	B
6.8	685	A		B	B		B	C
10	106		B		B	B	C	C
15	156	B		B	B		C	C
22	226			B	C		C	D
33	336	B	B	C	C	C	D	
47	476	B	C	C	C		D	
68	686	C		C	D	D		
100	107		C	D	D			
150	157	C	D	D				
220	227	D	D					
330	337	D						

# Hermetic Axial Capacitors



## TAA Series

### RATINGS AND PART NUMBER REFERENCE

AVX Part No.	Case Size	Capacitance $\mu\text{F}$	DCL ( $\mu\text{A}$ ) Max.	DF % Max.	ESR Max. ( $\Omega$ ) @ 100 kHz
<b>6.3 volt @ 85°C (4 volt @ 125°C)</b>					
TAAA225(+006)	A	2.2	0.5	4	N/A
TAAA335(+006)	A	3.3	0.5	4	N/A
TAAA475(+006)	A	4.7	0.5	4	N/A
TAAA685(+006)	A	6.8	0.5	6	5.0
TAAB156(+006)	B	15	1.0	6	2.3
TAAB336(+006)	B	3.3	1.0	6	2.0
TAAB476(+006)	B	47	3.0	6	1.6
TAAC686(+006)	C	68	4.5	6	1.0
TAAC157(+006)	C	150	9.5	8	0.8
TAAD227(+006)	D	220	14.0	8	0.6
TAAD337(+006)	D	330	20.0	8	0.5
<b>10 volt @ 85°C (6.3 volt @ 125°C)</b>					
TAAA475(+010)	A	4.7	0.5	6	5.0
TAAB106(+010)	B	10	1.0	6	2.6
TAAB336(+010)	B	33	3.5	6	1.6
TAAC476(+010)	C	47	3.0	6	1.1
TAAC107(+010)	C	100	10.0	6	1.0
TAAD157(+010)	D	150	15.0	8	0.8
TAAD227(+010)	D	220	20.0	8	0.5
<b>16 volt @ 85°C (10 volt @ 125°C)</b>					
TAAA335(+016)	A	3.3	0.5	6	6.0
TAAB685(+016)	B	6.8	0.8	6	2.5
TAAB156(+016)	B	15	2.4	6	2.0
TAAB226(+016)	B	22	3.5	6	1.6
TAAC336(+016)	C	33	5.8	6	1.2
TAAC476(+016)	C	47	7.3	6	1.0
TAAC686(+016)	C	68	10.0	6	0.8
TAAD107(+016)	D	100	15.0	6	0.7
TAAD157(+016)	D	150	20.0	8	0.5
<b>20 volt @ 85°C (13 volt @ 125°C)</b>					
TAAA155(+020)	A	1.5	0.5	4	9.0
TAAA225(+020)	A	2.2	0.5	4	6.5
TAAB475(+020)	B	4.7	0.8	4	3.0
TAAB685(+020)	B	6.8	1.0	6	2.5
TAAB106(+020)	B	10	2.0	6	2.6
TAAB156(+020)	B	15	3.0	6	1.8
TAAC226(+020)	C	22	4.5	6	1.3
TAAC336(+020)	C	33	7.0	6	1.2
TAAC476(+020)	C	47	9.5	6	0.9
TAAD686(+020)	D	68	13.5	6	0.8
TAAD107(+020)	D	100	20.0	6	0.5

AVX Part No.	Case Size	Capacitance $\mu\text{F}$	DCL ( $\mu\text{A}$ ) Max.	DF % Max.	ESR Max. ( $\Omega$ ) @ 100 kHz
<b>25 volt @ 85°C (17 volt @ 125°C)</b>					
TAAA684(+025)	A	6.8	0.5	4	9.5
TAAA155(+025)	A	1.5	0.5	4	7.5
TAAB475(+025)	B	4.7	1.2	4	2.8
TAAB106(+025)	B	10	2.5	6	2.0
TAAC336(+025)	C	33	8.5	6	1.0
TAAD686(+025)	D	68	15.0	6	0.6
<b>35 volt @ 85°C (23 volt @ 125°C)</b>					
TAAA104(+035)	A	0.10	0.5	4	N/A
TAAA154(+035)	A	0.15	0.5	4	N/A
TAAA224(+035)	A	0.22	0.5	4	N/A
TAAA334(+035)	A	0.33	0.5	4	N/A
TAAA474(+035)	A	0.47	0.5	4	N/A
TAAA684(+035)	A	0.68	0.5	4	10.0
TAAA105(+035)	A	1.0	0.5	4	8.0
TAAB155(+035)	B	1.5	0.5	4	6.0
TAAB225(+035)	B	2.2	1.0	4	6.0
TAAB335(+035)	B	3.3	1.0	4	3.5
TAAB475(+035)	B	4.7	1.5	4	2.5
TAAB685(+035)	B	6.8	2.5	6	2.0
TAAC106(+035)	C	10	3.5	6	1.6
TAAC156(+035)	C	15	5.0	6	1.2
TAAC226(+035)	C	22	7.5	6	1.0
TAAD336(+035)	D	33	10.0	6	0.8
TAAD476(+035)	D	47	10.0	6	0.6
<b>50 volt @ 85°C (33 volt @ 125°C)</b>					
TAAA104(+050)	A	0.10	0.5	4	N/A
TAAA154(+050)	A	0.15	0.5	4	N/A
TAAA224(+050)	A	0.22	0.5	4	N/A
TAAA334(+050)	A	0.33	0.5	4	N/A
TAAA474(+050)	A	0.47	0.5	4	N/A
TAAA684(+050)	A	0.68	0.5	4	10.0
TAAA105(+050)	A	1.0	0.5	4	8.0
TAAB155(+050)	B	1.5	0.8	4	6.0
TAAB225(+050)	B	2.2	1.1	6	6.0
TAAB335(+050)	B	3.3	1.7	6	3.5
TAAB475(+050)	B	4.7	2.4	6	2.5
TAAC685(+050)	C	6.8	3.4	6	2.0
TAAC106(+050)	C	10	5.0	6	1.6
TAAC156(+050)	C	15	7.5	6	1.2
TAAD226(+050)	D	22	11.0	6	1.0

(\*) Insert capacitance tolerance code; M for  $\pm 20\%$  and K for  $\pm 10\%$

NOTE: Voltage ratings are minimum values. AVX reserves the right to supply higher voltage ratings in the same case size.

# Axial Capacitors

## Tape and Reel Packaging



### SOLID TANTALUM AXIAL TAR AND TAA

#### TAPE AND REEL PACKAGING FOR AUTOMATIC COMPONENT INSERTION

TAR and TAA series are supplied as standard on axial bandolier, in reel format or 'ammo' pack for use on high speed axial automatic insertion equipment, or preforming machines.

The tape format is compatible with standards for component taping set out by major manufacturers of axial automatic insertion equipment.

#### TAPE SPECIFICATION

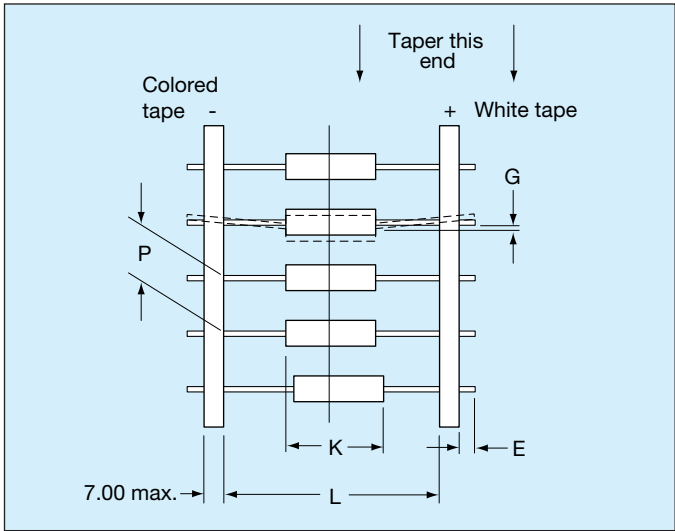

#### REEL CONFIGURATION

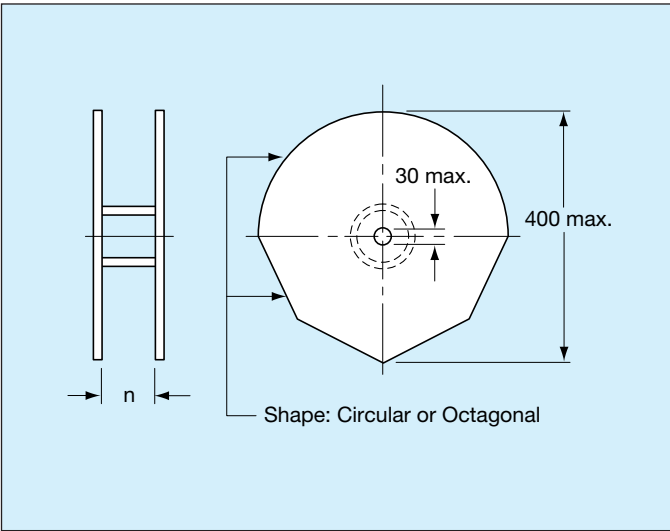

#### PACKAGING QUANTITIES TAR

For reels

Case Size	Number of Pieces
Q	4500
R	4000
S	2500
W	2500

#### PACKAGING QUANTITIES TAA

For reels, Standard Suffix G

Case Size	Number of Pieces
A	1000
B	1000
C	500
D	500

#### DIMENSIONS:

millimeters (inches)

E max	1.60 (0.063)
G max	1.20 (0.047)
K	Component body shall be located centrally within a window, width K, where K is 1.40 (0.060) greater than the primary body length
L	52.4 ± 1.50 (2.060 ± 0.060)
P	5.00 ± 0.50 (0.200 ± 0.020)
leader max	400 (15.75)
trailer max	30.0 (1.200)
n	Will allow for unhindered reeling and unreeling of the taped components. Preferred dimensions 73.0 (2.870) spacing.

# Section 4: Technical Summary and Application Guidelines



## INTRODUCTION

Tantalum capacitors are manufactured from a powder of pure tantalum metal. OxiCap™ - niobium oxide capacitor is made from niobium oxide NbO powder. The typical particle size is between 2 and 10 μm.

Figure below shows typical powders. Note the very great difference in particle size between the powder CVs/g.

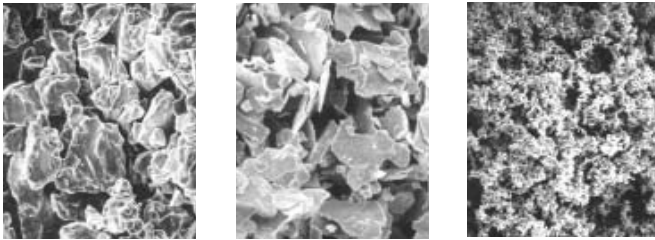

4000μFV

20000μFV

50000μFV

Figure 1a. Tantalum powder

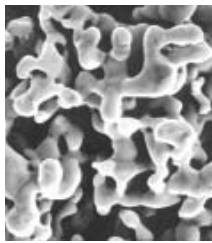

Figure 1b. Niobium Oxide powder

The powder is compressed under high pressure around a Tantalum or Niobium wire (known as the Riser Wire) to form a “pellet”. The riser wire is the anode connection to the capacitor.

This is subsequently vacuum sintered at high temperature (typically 1200 - 1800°C) which produces a mechanically strong pellet and drives off any impurities within the powder.

During sintering the powder becomes a sponge like structure with all the particles interconnected in a huge lattice.

This structure is of high mechanical strength and density, but is also highly porous giving a large internal surface area (see Figure 2).

The larger the surface area the larger the capacitance. Thus high CV/g (capacitance voltage product per gram) powders, which have a low average particle size, are used for low voltage, high capacitance parts.

By choosing which powder and sinter temperature is used to produce each capacitance/voltage rating the surface area can be controlled.

The following example uses a 220μF 6V capacitor to illustrate the point.

$$C = \frac{\epsilon_0 \epsilon_r A}{d}$$

where  $\epsilon_0$  is the dielectric constant of free space (8.855 x 10<sup>-12</sup> Farads/m)

$\epsilon_r$  is the relative dielectric constant

= 27 for Tantalum Pentoxide

= 41 for Niobium Pentoxide

$d$  is the dielectric thickness in meters

$C$  is the capacitance in Farads

and  $A$  is the surface area in meters

Rearranging this equation gives:

$$A = \frac{Cd}{\epsilon_0 \epsilon_r}$$

thus for a 220μF/6V capacitor the surface area is 346 square centimeters, or nearly one and a half times the size of this page.

The dielectric is then formed over all the Tantalum or niobium oxide surfaces by the electrochemical process of anodization. To activate this, the “pellet” is dipped into a very weak solution of phosphoric acid.

The dielectric thickness is controlled by the voltage applied during the forming process. Initially the power supply is kept in a constant current mode until the correct thickness of dielectric has been reached (that is the voltage reaches the ‘forming voltage’), it then switches to constant voltage mode and the current decays to close to zero.

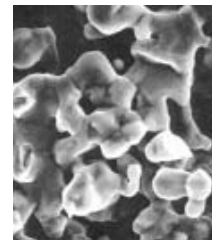
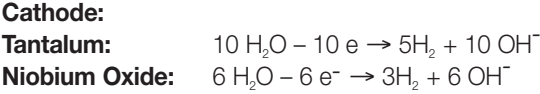
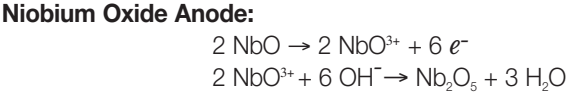
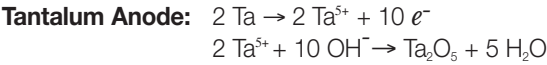

Figure 2. Sintered Anode

# Technical Summary and Application Guidelines



The chemical equations describing the process are as follows:



The oxide forms on the surface of the Tantalum or Niobium Oxide but it also grows into the material. For each unit of oxide two thirds grows out and one third grows in. It is for this reason that there is a limit on the maximum voltage rating of Tantalum & Niobium Oxide capacitors with present technology powders (see Figure 3).

The dielectric operates under high electrical stress. Consider a 220µF 6V part:

Formation voltage = Formation Ratio x Working Voltage  
 = 3.5 x 6  
 = 21 Volts

**Tantalum:**  
 The pentoxide ( $\text{Ta}_2\text{O}_5$ ) dielectric grows at a rate of  $1.7 \times 10^{-9}$  m/V

Dielectric thickness (d) =  $21 \times 1.7 \times 10^{-9}$   
 = 0.036 µm

Electric Field strength = Working Voltage / d  
 = 167 KV/mm

**Niobium Oxide:**  
 The niobium oxide ( $\text{Nb}_2\text{O}_5$ ) dielectric grows at a rate of  $2.4 \times 10^{-9}$  m/V

Dielectric thickness (d) =  $21 \times 2.4 \times 10^{-9}$   
 = 0.050 µm

Electric Field strength = Working Voltage / d  
 = 120 KV/mm

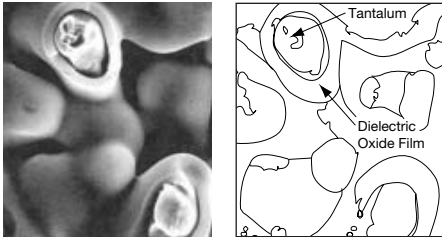

Figure 3. Dielectric layer

The next stage is the production of the cathode plate. This is achieved by pyrolysis of Manganese Nitrate into Manganese Dioxide.

The “pellet” is dipped into an aqueous solution of nitrate and then baked in an oven at approximately 250°C to produce the dioxide coat. The chemical equation is:



This process is repeated several times through varying specific densities of nitrate to build up a thick coat over all internal and external surfaces of the “pellet”, as shown in Figure 4.

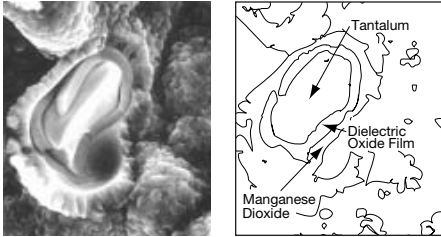

Figure 4. Manganese Dioxide Layer

The “pellet” is then dipped into graphite and silver to provide a good connection to the Manganese Dioxide cathode plate. Electrical contact is established by deposition of carbon onto the surface of the cathode. The carbon is then coated with a conductive material to facilitate connection to the cathode termination (see Figure 5). Packaging is carried out to meet individual specifications and customer requirements. This manufacturing technique is adhered to for the whole range of AVX Tantalum capacitors, which can be subdivided into four basic groups: Chip / Resin dipped / Rectangular boxed / Axial.

Further information on production of Tantalum Capacitors can be obtained from the technical paper “Basic Tantalum Technology”, by John Gill, available from your local AVX representative.

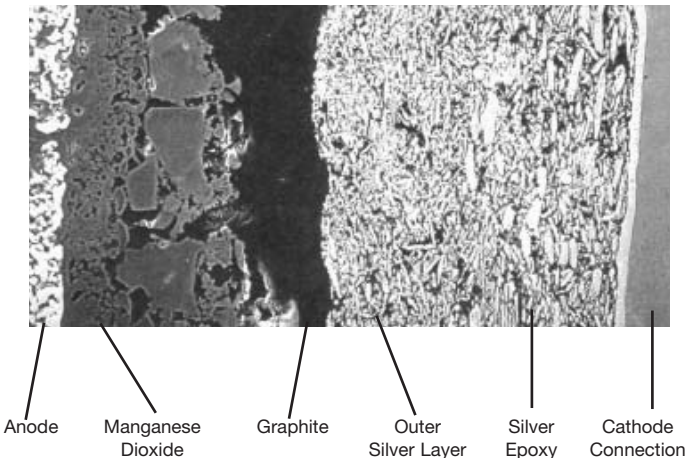

Figure 5. Cathode Termination

## SECTION 1 ELECTRICAL CHARACTERISTICS AND EXPLANATION OF TERMS

### 1.1 CAPACITANCE

#### 1.1.1 Rated capacitance ( $C_R$ ).

This is the nominal rated capacitance. For tantalum and OxiCap™ capacitors it is measured as the capacitance of the equivalent series circuit at 20°C using a measuring bridge supplied by a 0.5V rms 120Hz sinusoidal signal, free of harmonics with a bias of 2.2Vd.c.

#### 1.1.2 Capacitance tolerance.

This is the permissible variation of the actual value of the capacitance from the rated value. For additional reading, please consult the AVX technical publication "Capacitance Tolerances for Solid Tantalum Capacitors".

#### 1.1.3 Temperature dependence of capacitance.

The capacitance of a tantalum capacitor varies with temperature. This variation itself is dependent to a small extent on the rated voltage and capacitor size.

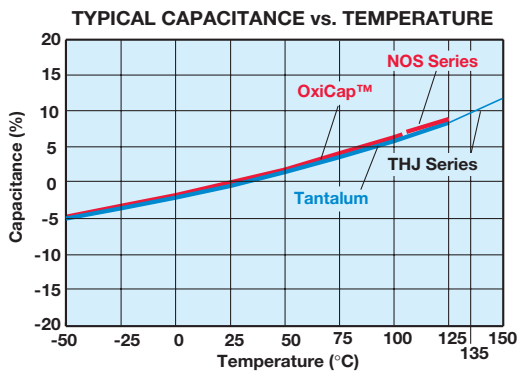

#### 1.1.4 Frequency dependence of the capacitance.

The effective capacitance decreases as frequency increases. Beyond 100kHz the capacitance continues to drop until resonance is reached (typically between 0.5 - 5MHz depending on the rating). Beyond the resonant frequency the device becomes inductive.

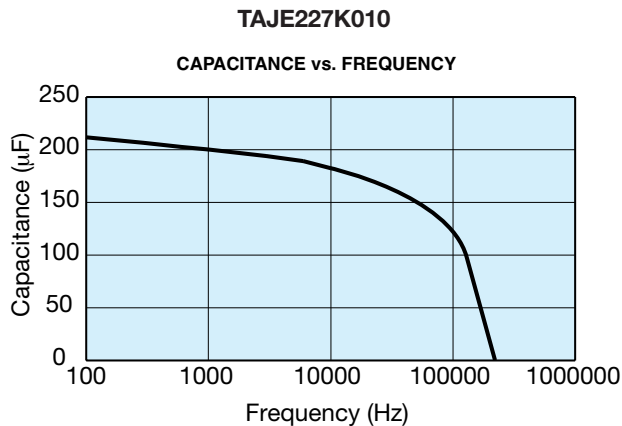

For individual part number please refer to SpiTan Software for frequency and temperature behavior found on AVX Corporation website.

### 1.2 VOLTAGE

#### 1.2.1 Rated d.c. voltage ( $V_R$ ).

This is the rated d.c. voltage for continuous operation at 85°C.

#### 1.2.2 Category voltage ( $V_C$ ).

This is the maximum voltage that may be applied continuously to a capacitor. It is equal to the rated voltage up to +85°C, beyond which it is subject to a linear derating, to 2/3  $V_R$  at 125°C for tantalum and 2/3  $V_R$  at 105°C for OxiCap™.

**MAXIMUM CATEGORY VOLTAGE vs. TEMPERATURE**

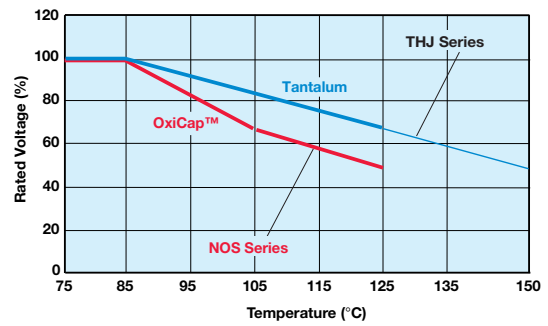

#### 1.2.3 Surge voltage ( $V_S$ ).

This is the highest voltage that may be applied to a capacitor for short periods of time in circuits with minimum series resistance of 330ohms (CECC states 1kΩ). The surge voltage may be applied up to 10 times in an hour for periods of up to 30 seconds at a time. The surge voltage must not be used as a parameter in the design of circuits in which, in the normal course of operation, the capacitor is periodically charged and discharged.

85°C Tantalum		125°C Tantalum*	
Rated Voltage (Vdc.)	Surge Voltage (Vdc.)	Category Voltage (Vdc.)	Surge Voltage (Vdc.)
4	5.2	2.7	3.2
6.3	8.2	4.2	5.0
10	13.0	6.7	8.0
16	20.8	10.7	12.8
20	26.0	13.3	16.0
25	32.5	16.7	20.0
35	45.5	23.3	28.0
50	65.0	33.3	40.0

85°C OxiCap™		105°C OxiCap™	
Rated Voltage (Vdc.)	Surge Voltage (Vdc.)	Category Voltage (Vdc.)	Surge Voltage (Vdc.)
4	5.2	2.7	3.2
6.3	8.2	4.2	5.0

\*For THJ 150°C Category & Surge voltage see THJ section on pages 47-49.

# Technical Summary and Application Guidelines



## 1.2.4 Effect of surges

The solid Tantalum and OxiCap™ capacitors have a limited ability to withstand voltage and current surges. This is in common with all other electrolytic capacitors and is due to the fact that they operate under very high electrical stress across the dielectric. For example a 6 volt tantalum capacitor has an Electrical Field of 167 kV/mm when operated at rated voltage. OxiCap™ capacitors operate at electrical field significantly less than 167 kV/mm.

It is important to ensure that the voltage across the terminals of the capacitor never exceeds the specified surge voltage rating.

Solid tantalum capacitors and OxiCap™ have a self healing ability provided by the Manganese Dioxide semiconducting layer used as the negative plate. However, this is limited in low impedance applications. In the case of low impedance circuits, the capacitor is likely to be stressed by current surges.

**Derating the capacitor increases the reliability of the component. (See Figure 2b page 109). The “AVX Recommended Derating Table” (page 111) summarizes voltage rating for use on common voltage rails, in low impedance applications for both Tantalum and OxiCap™ capacitors.**

**In circuits which undergo rapid charge or discharge a protective resistor of 1Ω/V is recommended. If this is impossible, a derating factor of up to 70% should be used on tantalum capacitors. OxiCap™ capacitors can be used with derating of 20% minimum.**

In such situations a higher voltage may be needed than is available as a single capacitor. A series combination should be used to increase the working voltage of the equivalent capacitor: For example, two 22μF 25V parts in series is equivalent to one 11μF 50V part. For further details refer to J.A. Gill's paper “Investigation into the Effects of Connecting Tantalum Capacitors in Series”, available from AVX offices worldwide.

### NOTE:

While testing a circuit (e.g. at ICT or functional) it is likely that the capacitors will be subjected to large voltage and current transients, which will not be seen in normal use. These conditions should be borne in mind when considering the capacitor's rated voltage for use. These can be controlled by ensuring a correct test resistance is used.

## 1.2.5 Reverse voltage and Non-Polar operation.

The values quoted are the maximum levels of reverse voltage which should appear on the capacitors at any time. These limits are based on the assumption that the capacitors are polarized in the correct direction for the majority of their working life. They are intended to cover short term reversals of polarity such as those occurring during switching transients or during a minor portion of an impressed waveform. Continuous application of reverse voltage without normal polarization will result in a degradation of leakage current. In conditions under which continuous application of a reverse

voltage could occur two similar capacitors should be used in a back-to-back configuration with the negative terminations connected together. Under most conditions this combination will have a capacitance one half of the nominal capacitance of either capacitor. Under conditions of isolated pulses or during the first few cycles, the capacitance may approach the full nominal value. The reverse voltage ratings are designed to cover exceptional conditions of small level excursions into incorrect polarity. The values quoted are not intended to cover continuous reverse operation.

The peak reverse voltage applied to the capacitor must not exceed:

10% of the rated d.c. working voltage to a maximum of 1.0v at 25°C

3% of the rated d.c. working voltage to a maximum of 0.5v at 85°C

1% of the rated d.c. working voltage to a maximum of 0.1v at 125°C (0.1v at 150°C THJ Series)

Note: Capacitance and DF values of OxiCap™ may exceed specification limits under these conditions.

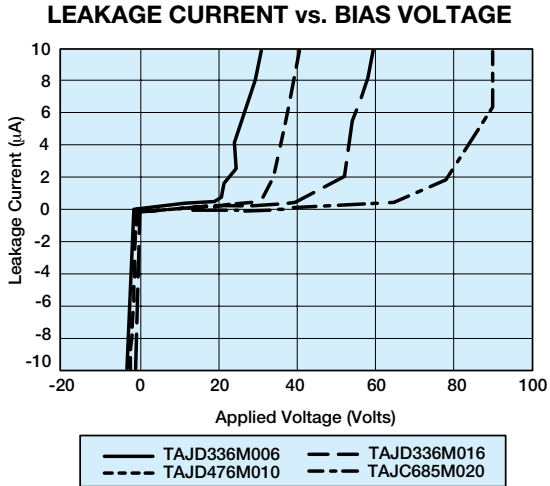

## 1.2.6 Superimposed A.C. Voltage (Vr.m.s.) - Ripple Voltage.

This is the maximum r.m.s. alternating voltage; superimposed on a d.c. voltage, that may be applied to a capacitor. The sum of the d.c. voltage and peak value of the superimposed a.c. voltage must not exceed the category voltage, v.c.

Full details are given in Section 2.

## 1.2.7 Forming voltage.

This is the voltage at which the anode oxide is formed. The thickness of this oxide layer is proportional to the formation voltage for a capacitor and is a factor in setting the rated voltage.



## 1.3 DISSIPATION FACTOR AND TANGENT OF LOSS ANGLE (TAN δ)

### 1.3.1 Dissipation factor (D.F.).

Dissipation factor is the measurement of the tangent of the loss angle ( $\tan \delta$ ) expressed as a percentage. The measurement of DF is carried out using a measuring bridge that supplies a 0.5V rms 120Hz sinusoidal signal, free of harmonics with a bias of 2.2Vdc. The value of DF is temperature and frequency dependent.

Note: For surface mounted products the maximum allowed DF values are indicated in the ratings table and it is important to note that these are the limits met by the component AFTER soldering onto the substrate.

### 1.3.2 Tangent of Loss Angle ( $\tan \delta$ ).

This is a measurement of the energy loss in the capacitor. It is expressed, as  $\tan \delta$  and is the power loss of the capacitor divided by its reactive power at a sinusoidal voltage of specified frequency. Terms also used are power factor, loss factor and dielectric loss.  $\cos(90 - \delta)$  is the true power factor. The measurement of  $\tan \delta$  is carried out using a measuring bridge that supplies a 0.5V rms 120Hz sinusoidal signal, free of harmonics with a bias of 2.2Vdc.

### 1.3.3 Frequency dependence of Dissipation Factor.

Dissipation Factor increases with frequency as shown in the typical curves that are for tantalum and OxiCap™ capacitors identical:

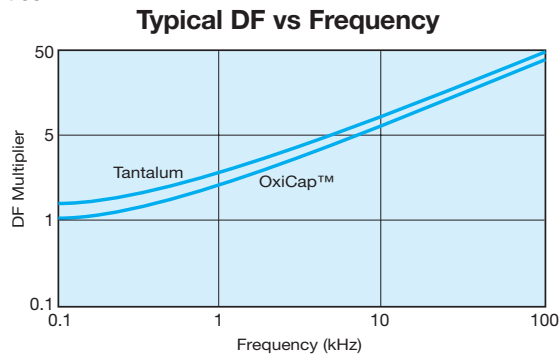

### 1.3.4 Temperature dependence of Dissipation Factor.

Dissipation factor varies with temperature as the typical curves show. These plots are identical for both Tantalum and OxiCap™ capacitors. For maximum limits please refer to ratings tables.

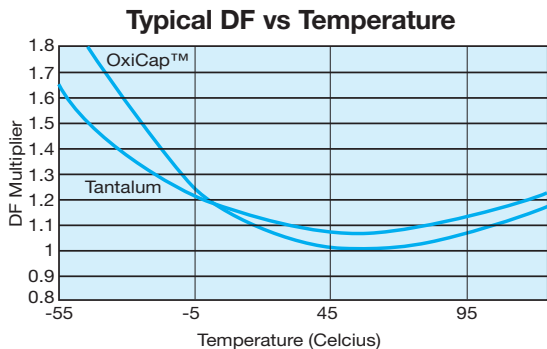

## 1.4 IMPEDANCE, (Z) AND EQUIVALENT SERIES RESISTANCE (ESR)

### 1.4.1 Impedance, Z.

This is the ratio of voltage to current at a specified frequency. Three factors contribute to the impedance of a Tantalum capacitor; the resistance of the semiconductor layer; the capacitance value and the inductance of the electrodes and leads.

At high frequencies the inductance of the leads becomes a limiting factor. The temperature and frequency behavior of these three factors of impedance determine the behavior of the impedance Z. The impedance is measured at 20°C and 100kHz.

### 1.4.2 Equivalent Series Resistance, ESR.

Resistance losses occur in all practical forms of capacitors. These are made up from several different mechanisms, including resistance in components and contacts, viscous forces within the dielectric and defects producing bypass current paths. To express the effect of these losses they are considered as the ESR of the capacitor. The ESR is frequency dependent and can be found by using the relationship;

$$ESR = \frac{\tan \delta}{2\pi fC}$$

Where f is the frequency in Hz, and C is the capacitance in farads.

The ESR is measured at 20°C and 100kHz.

ESR is one of the contributing factors to impedance, and at high frequencies (100kHz and above) it becomes the dominant factor. Thus ESR and impedance become almost identical, impedance being only marginally higher.

### 1.4.3 Frequency dependence of Impedance and ESR.

ESR and Impedance both increase with decreasing frequency. At lower frequencies the values diverge as the extra contributions to impedance (due to the reactance of the capacitor) become more significant. Beyond 1MHz (and beyond the resonant point of the capacitor) impedance again increases due to the inductance of the capacitor. Typical ESR and Impedance values are similar for both tantalum and niobium oxide materials and thus the same charts are valid for both for Tantalum and OxiCap™ capacitors.

### Typical ESR vs Frequency

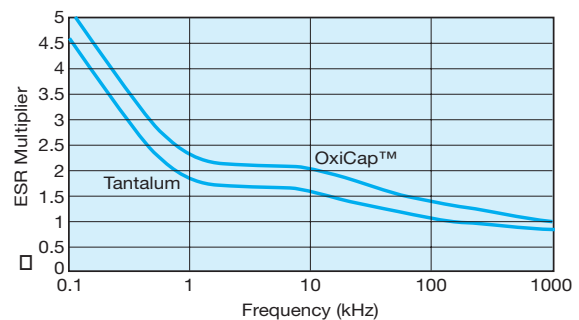

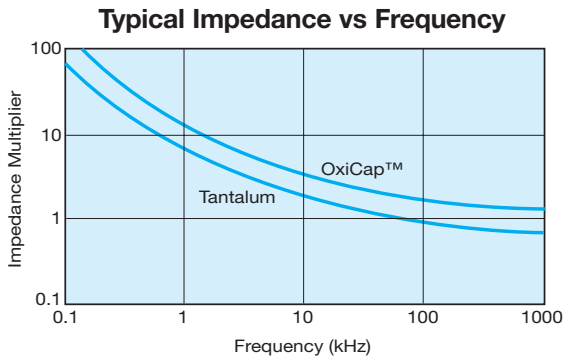

## 1.4.4 Temperature dependence of the Impedance and ESR.

At 100kHz, impedance and ESR behave identically and decrease with increasing temperature as the typical curves show.

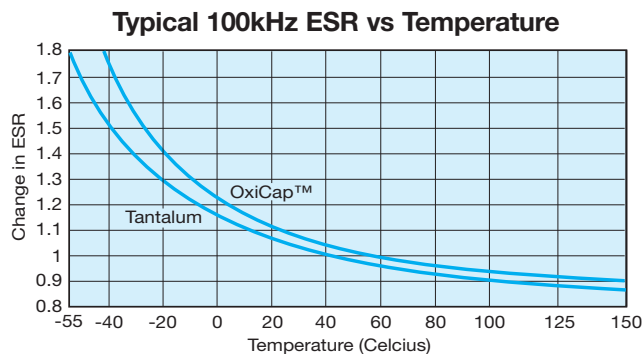

## 1.5 D.C. LEAKAGE CURRENT

### 1.5.1 Leakage current.

The leakage current is dependent on the voltage applied, the elapsed time since the voltage was applied and the component temperature. It is measured at +20°C with the rated voltage applied. A protective resistance of 1000Ω is connected in series with the capacitor in the measuring circuit. Three to five minutes after application of the rated voltage the leakage current must not exceed the maximum values indicated in the ratings table. These are based on the formula 0.01CV or 0.5μA (whichever is the greater) for tantalum and 0.02CV or 1.0μA (whichever is the greater) for OxiCap™ capacitors.

Reforming of Tantalum or OxiCap™ capacitors is unnecessary even after prolonged storage periods without the application of voltage.

### 1.5.2 Temperature dependence of the leakage current.

The leakage current increases with higher temperatures; typical values are shown in the graph. For operation between 85°C and 125°C, the maximum working voltage must be derated and can be found from the following formula.

$$V_{max} = \left(1 - \frac{(T - 85)}{125}\right) \times V_R$$

where T is the required operating temperature.

## LEAKAGE CURRENT vs. TEMPERATURE

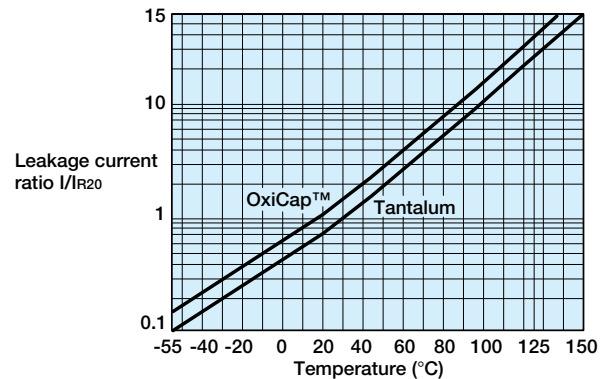

### 1.5.3 Voltage dependence of the leakage current.

The leakage current drops rapidly below the value corresponding to the rated voltage  $V_R$  when reduced voltages are applied. The effect of voltage derating on the leakage current is shown in the graph. This will also give a significant increase in the reliability for any application. See Section 3.1 (page 109) for details.

## LEAKAGE CURRENT vs. RATED VOLTAGE

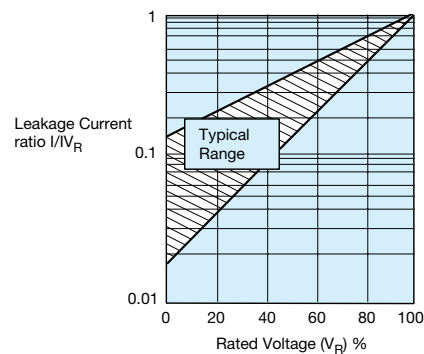

For additional information on Leakage Current, please consult the AVX technical publication "Analysis of Solid Tantalum Capacitor Leakage Current" by R. W. Franklin.

### 1.5.4 Ripple current.

The maximum ripple current allowed is derived from the power dissipation limits for a given temperature rise above ambient temperature (please refer to Section 2, pages 106-108).

## 1.6 SELF INDUCTANCE (ESL)

The self-inductance value (ESL) can be important for resonance frequency evaluation. See figure below typical ESL values per case size.

### TAJ/TPS/THJ/TRJ/TPM/CWR11/NOJ/NOS

Case Size	Typical Self-Inductance value (nH)	Case Size	Typical Self-Inductance value (nH)
A	1.8	T	1.8
B	1.8	V	2.4
C	2.2	W	2.2
D	2.4	Y	2.4
E	2.5	X	2.4
R	1.4	P	1.4
S	1.8		

### TAC

Case Size	Typical Self-Inductance value (nH)
K	1.1
L	1.2
R	1.4

## SECTION 2

### A.C. OPERATION, RIPPLE VOLTAGE AND RIPPLE CURRENT

#### 2.1 RIPPLE RATINGS (A.C.)

In an a.c. application heat is generated within the capacitor by both the a.c. component of the signal (which will depend upon the signal form, amplitude and frequency), and by the d.c. leakage. For practical purposes the second factor is insignificant. The actual power dissipated in the capacitor is calculated using the formula:

$$P = I^2 R$$

and rearranged to  $I = \text{SQRT}(P/R)$  .....(Eq. 1)

where  $I$  = rms ripple current, amperes  
 $R$  = equivalent series resistance, ohms  
 $U$  = rms ripple voltage, volts  
 $P$  = power dissipated, watts  
 $Z$  = impedance, ohms, at frequency under consideration

Maximum a.c. ripple voltage ( $U_{\text{max}}$ ).

From the Ohms' law equation:

$$U_{\text{max}} = IR \text{ .....(Eq. 2)}$$

Where  $P$  is the maximum permissible power dissipated as listed for the product under consideration (see tables).

However care must be taken to ensure that:

1. The d.c. working voltage of the capacitor must not be exceeded by the sum of the positive peak of the applied a.c. voltage and the d.c. bias voltage.
2. The sum of the applied d.c. bias voltage and the negative peak of the a.c. voltage must not allow a voltage reversal in excess of the "Reverse Voltage".

#### Historical ripple calculations.

Previous ripple current and voltage values were calculated using an empirically derived power dissipation required to give a 10°C rise of the capacitors body temperature from room temperature, usually in free air. These values are shown in Table I. Equation 1 then allows the maximum ripple current to be established, and Equation 2, the maximum ripple voltage. But as has been shown in the AVX article on thermal management by I. Salisbury, the thermal conductivity of a Tantalum chip capacitor varies considerably depending upon how it is mounted.

Table I: Power Dissipation Ratings (In Free Air)

TAJ/TPS/THJ/TRJ/TPM/TCJ/TLJ/CWR11/NOJ/NOS/NOM Series Molded Chip					TAZ/CWR09 Series Molded Chip		TAJ/TPS/THJ/TRJ/TPM TCJ/TLJ/CWR11/TAZ CWR09/TAC Series Molded Chip	
Case size	Max. power dissipation (W)				Case size	Max. power dissipation (W)	Temperature correction factor for ripple current	
	Tantalum		OxiCap™				Temp. °C	Factor
	TAJ/TPS/THJ/TRJ/TCJ/TLJ/CWR11	TPM	NOJ/NOS	NOM				
A	0.075	—	0.090	—	A	0.050	+25	1.00
B	0.085	—	0.102	—	B	0.070	+55	0.95
C	0.110	—	0.132	—	C	0.075	+85	0.90
D	0.150	—	0.180	—	D	0.080	+125	0.40
E	0.165	0.270	0.198	0.324	E	0.090	+150 (THJ)	0.20
R	0.055	—	—	—	F	0.100		
S	0.065	—	—	—	G	0.125		
T	0.080	—	—	—	H	0.150		
V	0.250	0.285	0.300	—	TACmicrochip™		Temperature correction factor for ripple current	
W	0.090	—	—	—	Case size	Max. power dissipation (W)	Temp. °C	Factor
Y	0.125	—	—	—	K	0.015	+25	1.00
X	0.100	—	—	—	L	0.025	+55	0.95
P	0.060	—	—	—	R	0.045	+85	0.90
					H	0.040	+105	0.40
					U	0.035	+125 (NOS)	0.40
					X	0.040		
					A	0.040		

# Technical Summary and Application Guidelines



A piece of equipment was designed which would pass sine and square wave currents of varying amplitudes through a biased capacitor. The temperature rise seen on the body for the capacitor was then measured using an infra-red probe. This ensured that there was no heat loss through any thermo-couple attached to the capacitor's surface.

Results for the C, D and E case sizes

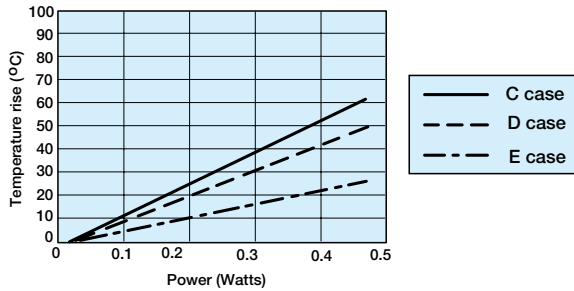

Several capacitors were tested and the combined results are shown above. All these capacitors were measured on FR4 board, with no other heat sinking. The ripple was supplied at various frequencies from 1kHz to 1MHz.

As can be seen in the figure above, the average  $P_{max}$  value for the C case capacitors was 0.11 Watts. This is the same as that quoted in Table I.

The D case capacitors gave an average  $P_{max}$  value 0.125 Watts. This is lower than the value quoted in the Table I by 0.025 Watts. The E case capacitors gave an average  $P_{max}$  of 0.200 Watts that was much higher than the 0.165 Watts from Table I.

If a typical capacitor's ESR with frequency is considered, e.g. figure below, it can be seen that there is variation. Thus for a set ripple current, the amount of power to be dissipated by the capacitor will vary with frequency. This is clearly shown in figure in top of next column, which shows that the surface temperature of the unit raises less for a given value of ripple current at 1MHz than at 100kHz.

The graph below shows a typical ESR variation with frequency. Typical ripple current versus temperature rise for 100kHz and 1MHz sine wave inputs.

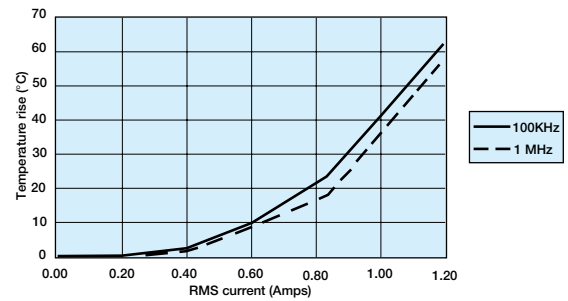
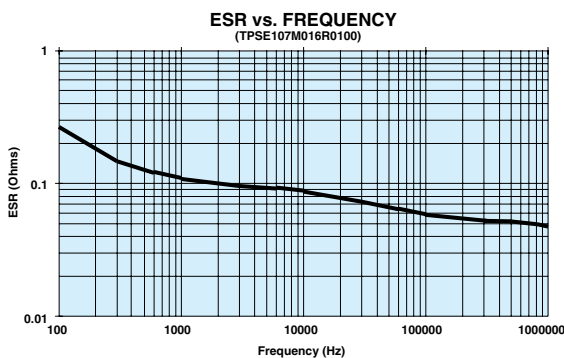

If  $I^2R$  is then plotted it can be seen that the two lines are in fact coincident, as shown in figure below.

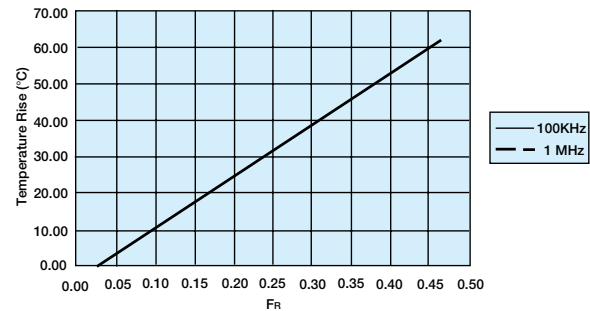

## Example

A Tantalum capacitor is being used in a filtering application, where it will be required to handle a 2 Amp peak-to-peak, 200kHz square wave current.

A square wave is the sum of an infinite series of sine waves at all the odd harmonics of the square waves fundamental frequency. The equation which relates is:

$$I_{\text{Square}} = I_{pk} \sin(2\pi f) + I_{pk} \sin(6\pi f) + I_{pk} \sin(10\pi f) + I_{pk} \sin(14\pi f) + \dots$$

Thus the special components are:

Frequency	Peak-to-peak current (Amps)	RMS current (Amps)
200 KHz	2.000	0.707
600 KHz	0.667	0.236
1 MHz	0.400	0.141
1.4 MHz	0.286	0.101

Let us assume the capacitor is a TAJD686M006  
Typical ESR measurements would yield.

Frequency	Typical ESR (Ohms)	Power (Watts) $I_{rms}^2 \times ESR$
200 KHz	0.120	0.060
600 KHz	0.115	0.006
1 MHz	0.090	0.002
1.4 MHz	0.100	0.001

Thus the total power dissipation would be 0.069 Watts.

From the D case results shown in figure top of previous column, it can be seen that this power would cause the capacitors surface temperature to rise by about 5°C. For additional information, please refer to the AVX technical publication "Ripple Rating of Tantalum Chip Capacitors" by R.W. Franklin.

# Technical Summary and Application Guidelines



## 2.2 OXICAP™ RIPPLE RATING

OxiCap™ capacitors showing 20% higher power dissipation allowed compared to tantalum capacitors as a result of twice higher specific heat of niobium oxide compared to Tantalum

powders. (Specific heat is related to energy necessary to heat a defined volume of material to a specified temperature.)

## 2.3 THERMAL MANAGEMENT

The heat generated inside a tantalum capacitor in a.c. operation comes from the power dissipation due to ripple current. It is equal to  $I^2R$ , where  $I$  is the rms value of the current at a given frequency, and  $R$  is the ESR at the same frequency with an additional contribution due to the leakage current. The heat will be transferred from the outer surface by conduction. How efficiently it is transferred from this point is dependent on the thermal management of the board.

In practice, in a high density assembly with no specific thermal management, the power dissipation required to give a 10°C rise above ambient may be up to a factor of 10 less. In these cases, the actual capacitor temperature should be established (either by thermocouple probe or infra-red scanner) and if it is seen to be above this limit it may be necessary to specify a lower ESR part or a higher voltage rating.

The power dissipation ratings given in Section 2.1 (pages 105-107) are based on free-air calculations. These ratings can be approached if efficient heat sinking and/or forced cooling is used.

Please contact application engineering for details or contact the AVX technical publication entitled “Thermal Management of Surface Mounted Tantalum Capacitors” by Ian Salisbury.

**Thermal Dissipation from the Mounted Chip**

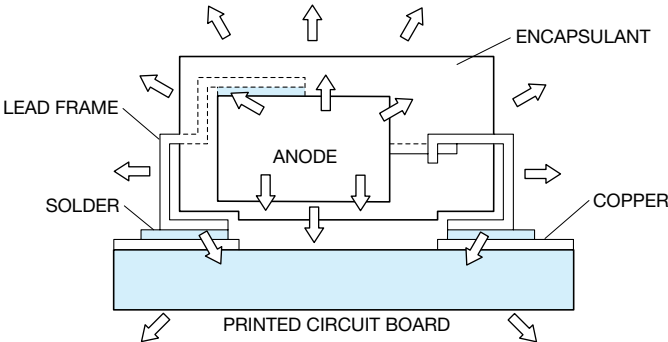

**Thermal Impedance Graph with Ripple Current**

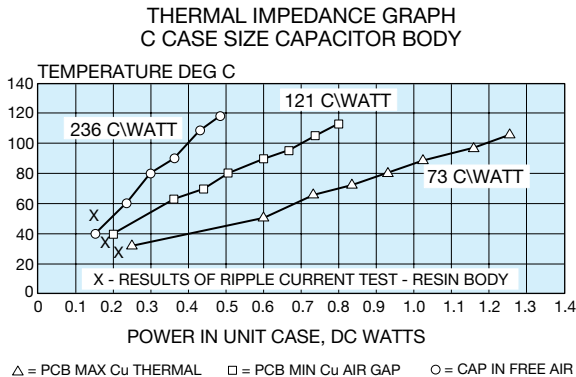

## SECTION 3 RELIABILITY AND CALCULATION OF FAILURE RATE

### 3.1 STEADY-STATE

Both Tantalum and Niobium Oxide dielectric have essentially no wear out mechanism and in certain circumstances is capable of limited self healing. However, random failures can occur in operation. The failure rate of Tantalum capacitors will decrease with time and not increase as with other electrolytic capacitors and other electronic components.

Figure 1. Tantalum and OxiCap™ Reliability Curve

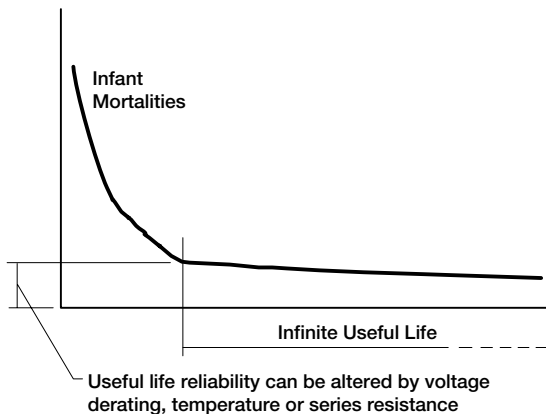

The useful life reliability of the Tantalum and OxiCap™ capacitors in steady-state is affected by three factors. The equation from which the failure rate can be calculated is:

$$F = F_V \times F_T \times F_R \times F_B$$

where  $F_V$  is a correction factor due to operating voltage/voltage derating

$F_T$  is a correction factor due to operating temperature

$F_R$  is a correction factor due to circuit series resistance

$F_B$  is the basic failure rate level

$F_B = 1.0\% / 1000$  hours for TPS, TAJ, TAC, TPM and TCJ

0.5% / 1000 hours for TRJ, THJ and NOJ

0.2% / 100 hours for NOS, NOM and TLJ

#### Base failure rate.

Standard Tantalum and OxiCap™ products conform to Level M reliability or better (i.e., 1%/1000 hrs.) at rated voltage, rated temperature, and 0.1Ω/volt circuit impedance. This is known as the base failure rate,  $F_B$ , which is used for calculating operating reliability. The effect of varying the operating conditions on failure rate is shown on this page.

#### Operating voltage/voltage derating.

If a capacitor with a higher voltage rating than the maximum line voltage is used, then the operating reliability will be improved. This is known as voltage derating.

The graph, Figure 2a, shows the relationship between voltage derating (the ratio between applied and rated voltage) and the failure rate. The graph gives the correction factor  $F_U$  for any operating voltage.

Figure 2a. Correction factor to failure rate  $F_R$  for voltage derating of a typical component (60% con. level).

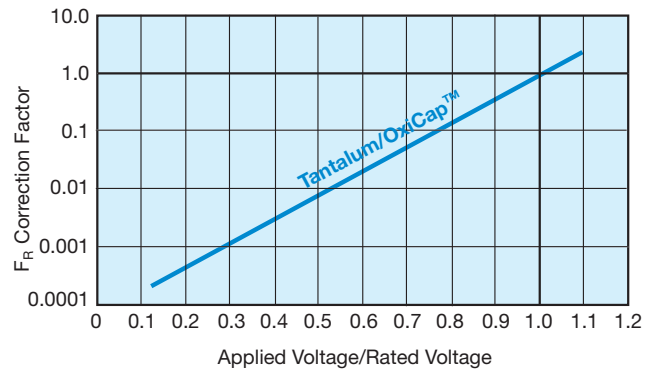

Figure 2b. Gives our recommendation for voltage derating for tantalum capacitors to be used in typical applications.

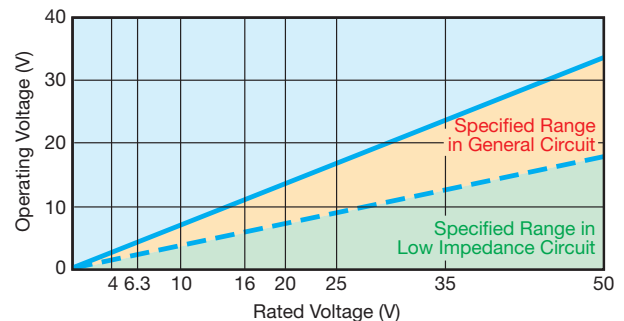
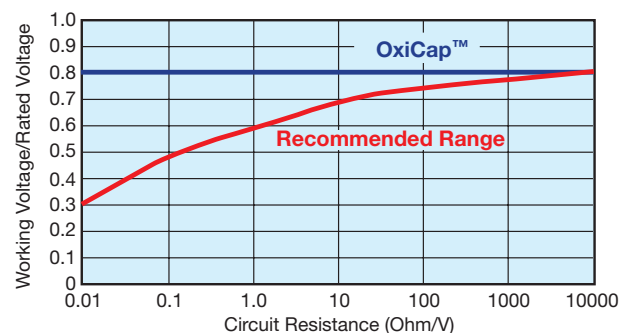

Figure 2c. Gives voltage derating recommendations for tantalum capacitors as a function of circuit impedance.



# Technical Summary and Application Guidelines

### Operating Temperature.

If the operating temperature is below the rated temperature for the capacitor then the operating reliability will be improved as shown in Figure 3. This graph gives a correction factor  $F_T$  for any temperature of operation.

Figure 3: Correction factor to failure rate  $F_R$  for ambient temperature  $T$  for typical component (60% con. level).

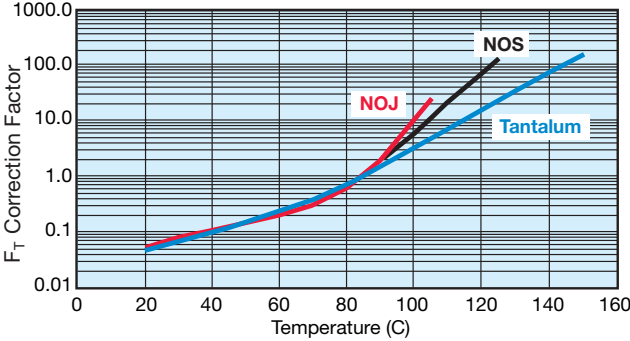

### Circuit Impedance.

All solid Tantalum and/or niobium oxide capacitors require current limiting resistance to protect the dielectric from surges. A series resistor is recommended for this purpose. A lower circuit impedance may cause an increase in failure rate, especially at temperatures higher than 20°C. An inductive low impedance circuit may apply voltage surges to the capacitor and similarly a non-inductive circuit may apply current surges to the capacitor, causing localized over-heating and failure. The recommended impedance is 1  $\Omega$  per volt. Where this is not feasible, equivalent voltage derating should be used (See MIL HANDBOOK 217E). The graph, Figure 4, shows the correction factor,  $F_R$ , for increasing series resistance.

Figure 4. Correction factor to failure rate  $F_R$  for series resistance  $R$  on basic failure rate  $F_B$  for a typical component (60% con. level).

Circuit resistance ohms/volt	$F_R$
3.0	0.07
2.0	0.1
1.0	0.2
0.8	0.3
0.6	0.4
0.4	0.6
0.2	0.8
0.1	1.0

For circuit impedances below 0.1 ohms per volt, or for any mission critical application, circuit protection should be considered. An ideal solution would be to employ an AVX SMT thin-film fuse in series.

### Example calculation.

Consider a 12 volt power line. The designer needs about 10 $\mu$ F of capacitance to act as a decoupling capacitor near a video bandwidth amplifier. Thus the circuit impedance will be limited only by the output impedance of the board's power unit and the track resistance. Let us assume it to be about 2 Ohms minimum, i.e. 0.167 Ohms/Volt. The operating temperature range is -25°C to +85°C.

If a 10 $\mu$ F 16 Volt capacitor was designed in the operating failure rate would be as follows.

- a)  $F_T = 1.0$  @ 85°C
- b)  $F_R = 0.85$  @ 0.167 Ohms/Volt
- c)  $F_V = 0.08$  @ applied voltage/rated voltage = 75%
- d)  $F_B = 1\%/1000$  hours, basic failure rate level

Thus  $F = 1.0 \times 0.85 \times 0.08 \times 1 = 0.068\%/1000$  Hours

If the capacitor was changed for a 20 volt capacitor, the operating failure rate will change as shown.

$F_V = 0.018$  @ applied voltage/rated voltage = 60%  
 $F = 1.0 \times 0.85 \times 0.018 \times 1 = 0.0153\%/1000$  Hours

### 3.2 Dynamic.

As stated in Section 1.2.4 (page 103), the solid capacitor has a limited ability to withstand voltage and current surges. Such current surges can cause a capacitor to fail. The expected failure rate cannot be calculated by a simple formula as in the case of steady-state reliability. The two parameters under the control of the circuit design engineer known to reduce the incidence of failures are derating and series resistance.

The table below summarizes the results of trials carried out at AVX with a piece of equipment, which has very low series resistance with no voltage derating applied. That is if the capacitor was tested at its rated voltage. It has been tested on tantalum capacitors, however the conclusions are valid for both tantalum and OxiCap™ capacitors.

### Results of production scale derating experiment

Capacitance and Voltage	Number of units tested	50% derating applied	No derating applied
47 $\mu$ F 16V	1,547,587	0.03%	1.1%
100 $\mu$ F 10V	632,876	0.01%	0.5%
22 $\mu$ F 25V	2,256,258	0.05%	0.3%

As can clearly be seen from the results of this experiment, the more derating applied by the user, the less likely the probability of a surge failure occurring.

It must be remembered that these results were derived from a highly accelerated surge test machine, and failure rates in the low ppm are more likely with the end customer.

A commonly held misconception is that the leakage current of a Tantalum capacitor can predict the number of failures which will be seen on a surge screen. This can be disproved by the results of an experiment carried out at AVX on 47 $\mu$ F

# Technical Summary and Application Guidelines

10V surface mount capacitors with different leakage currents. The results are summarized in the table below.

### Leakage current vs number of surge failures.

Again, it must be remembered that these results were derived from a highly accelerated surge test machine, and failure rates in the low ppm are more likely with the end customer.

	Number tested	Number failed surge
Standard leakage range 0.1 μA to 1μA	10,000	25
Over Catalog limit 5μA to 50μA	10,000	26
Classified Short Circuit 50μA to 500μA	10,000	25

OxiCap™ capacitor is less sensitive to an overloading stress compared to Tantalum and so a 20% minimum derating is recommended. It may be necessary in extreme low impedance circuits of high transient or 'switch-on' currents to derate the voltage further. Hence in general a lower voltage OxiCap™ part number can be placed on a higher rail voltage compared to the tantalum capacitor – see table below.

### AVX recommended derating table.

Voltage Rail (V)	Rated Voltage of Cap (V)	
	Tantalum	OxiCap™
3.3	6.3	4
5	10	6.3
10	20	–
12	25	–
15	35	–
>24	Series Combination	–

For further details on surge in Tantalum capacitors refer to J.A. Gill's paper "Surge in Solid Tantalum Capacitors", available from AVX offices worldwide.

An added bonus of increasing the derating applied in a circuit, to improve the ability of the capacitor to withstand surge conditions, is that the steady-state reliability is improved by up to an order. Consider the example of a 6.3 volt capacitor being used on a 5 volt rail.

The steady-state reliability of a Tantalum capacitor is affected by three parameters; temperature, series resistance and voltage derating. Assume 40°C operation and 0.1 Ohms/Volt series resistance.

The capacitors reliability will therefore be:

$$\begin{aligned}
 \text{Failure rate} &= F_U \times F_T \times F_R \times 1\%/1000 \text{ hours} \\
 &= 0.15 \times 0.1 \times 1 \times 1\%/1000 \text{ hours} \\
 &= 0.015\%/1000 \text{ hours}
 \end{aligned}$$

If a 10 volt capacitor was used instead, the new scaling factor would be 0.006, thus the steady-state reliability would be:

$$\begin{aligned}
 \text{Failure rate} &= F_U \times F_T \times F_R \times 1\%/1000 \text{ hours} \\
 &= 0.006 \times 0.1 \times 1 \times 1\%/1000 \text{ hours} \\
 &= 6 \times 10^{-4} \%/1000 \text{ hours}
 \end{aligned}$$



# Technical Summary and Application Guidelines



## SECTION 4 APPLICATION GUIDELINES FOR TANTALUM AND OXICAP™ CAPACITORS

So there is an order improvement in the capacitors steady-state reliability.

### Soldering Conditions and Board Attachment.

The soldering temperature and time should be the minimum for a good connection.

A suitable combination for wavesoldering is 230°C - 250°C for 3 - 5 seconds.

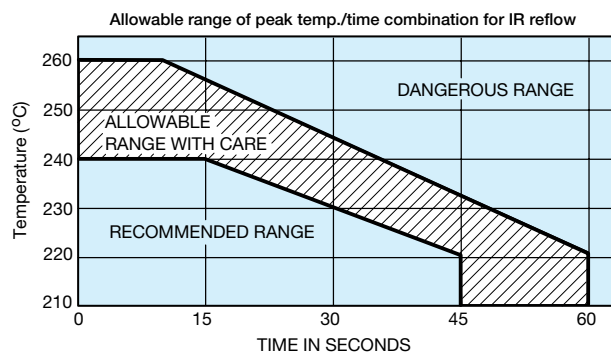

For vapor phase or infra-red reflow soldering the profile below shows allowable and dangerous time/temperature combinations. The profile refers to the peak reflow temperature and is designed to ensure that the temperature of the internal construction of the capacitor does not exceed 220°C. Preheat conditions vary according to the reflow system used, maximum time and temperature would be 10 minutes at 150°C. Small parametric shifts may be noted immediately after reflow, components should be allowed to stabilize at room temperature prior to electrical testing.

Reflow profile requirements may be affected by lead environmental concerns and thus lead-free soldering system introduction within electronic industry.

Both Tantalum and OxiCap™ are lead-free system compatible components. See the next section for AVX recommendation and details.

TAJ, NOJ and TAZ series are designed for reflow and wave soldering operations. In addition, these series are available with gold termination options compatible with conductive epoxy mounting. Gold finish suitable for wire bonding for hybrid assemblies are available upon request.

Under the CECC 00 802 International Specification, AVX Tantalum capacitors and OxiCap™ are Class A components. The capacitors can therefore be subjected to one IR reflow, one wave solder and one soldering iron cycle. If more aggressive mounting techniques are to be used please consult AVX Tantalum for guidance.

Allowable range of peak temp./time combination for wave soldering

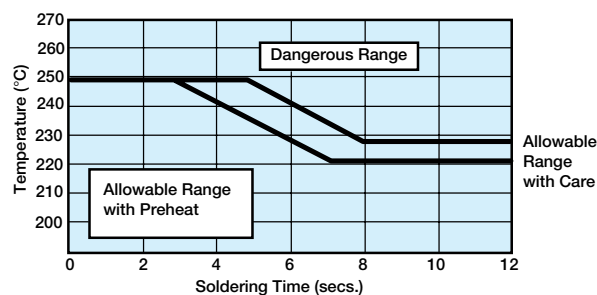

# Technical Summary and Application Guidelines



## SECTION 4 (continued)

### APPLICATION GUIDELINES FOR TANTALUM AND OXICAP™ CAPACITORS

Recommended soldering profiles for surface mounting of tantalum capacitors is provided in figure below.

#### IR REFLOW

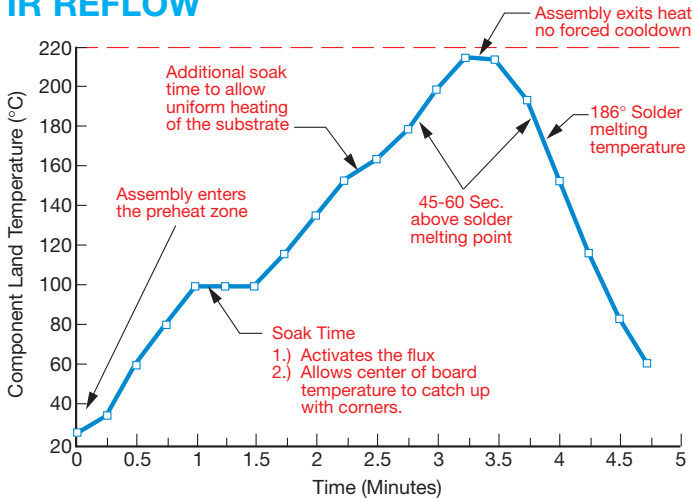

Recommended Ramp Rate Less than 2°C/sec.

#### WAVE SOLDERING

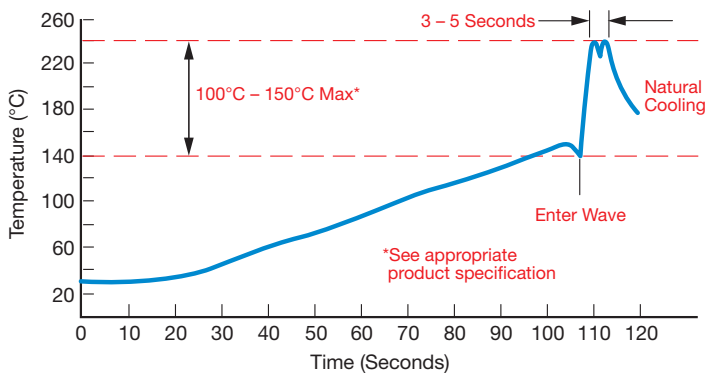

#### GENERAL LEAD-FREE NOTES

The following should be noted by customers changing from lead based systems to the new lead free pastes.

- The visual standards used for evaluation of solder joints will need to be modified as lead free joints are not as bright as with tin-lead pastes and the fillet may not be as large.
- Resin color may darken slightly due to the increase in temperature required for the new pastes.
- Lead-free solder pastes do not allow the same self alignment as lead containing systems. Standard mounting pads are acceptable, but machine set up may need to be modified.

#### LEAD-FREE PROGRAM

AVX also offers 100% Tin termination finish on its TAJ, TPS, THJ, NOJ and NOS series surface mount Tantalum capacitors.

After that date all products are available with lead-free terminations per requests. Refer the the first page of each series for order.

TAC standard termination is barrier nickel overlated with pure tin (Lead-Free).

A barrier nickel and gold termination suitable for conductive epoxy is available. Other gold finishes are available upon request.

The 100% Tin termination is compatible with and all common lead free pastes; SnCu, SnAgCu, SnCuAgBi, etc.

**It is also compatible with existing SnPb solder pastes / systems in use today.**

The recommended IR reflow profile is shown below.

#### RECOMMENDED LEAD-FREE REFLOW PROFILE

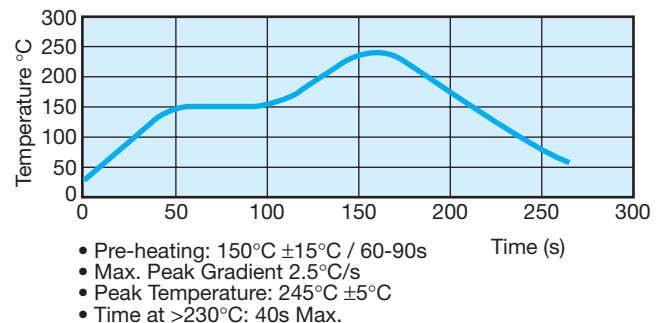

#### LEAD-FREE WAVE SOLDERING

The recommended peak temperature for lead-free wave soldering is 250°C-260°C for 3-5 seconds. The other parameters of the profile remains the same as above.

#### MOISTURE SENSITIVITY LEVELS (according to J-STD-020C)

Level 1 for TAJ, TPS, THJ, TRJ, TPM, NOJ, NOS, NOM  
Level 3 for TLJ, TCJ

# Technical Summary and Application Guidelines



## SECTION 5 MECHANICAL AND THERMAL PROPERTIES OF CAPACITORS

### 5.1 Acceleration

98.1m/s<sup>2</sup> (10g)

### 5.2 Vibration Severity

10 to 2000Hz, 0.75mm of 98.1m/s<sup>2</sup> (10g)

### 5.3 Shock

Trapezoidal Pulse, 98.1m/s<sup>2</sup> for 6ms.

### 5.4 Adhesion to Substrate

IEC 384-3. minimum of 5N.

### 5.5 Resistance to Substrate Bending

The component has compliant leads which reduces the risk of stress on the capacitor due to substrate bending.

### 5.6 Soldering Conditions

Dip soldering is permissible provided the solder bath temperature is  $\leq 270^{\circ}\text{C}$ , the solder time  $< 3$  seconds and the circuit board thickness  $\geq 1.0\text{mm}$ .

### 5.7 Installation Instructions

The upper temperature limit (maximum capacitor surface temperature) must not be exceeded even under the most unfavorable conditions when the capacitor is installed. This must be considered particularly when it is positioned near components which radiate heat strongly (e.g. valves and power transistors). Furthermore, care must be taken, when bending the wires, that the bending forces do not strain the capacitor housing.

### 5.8 Installation Position

No restriction.

### 5.9 Soldering Instructions

Fluxes containing acids must not be used.

#### 5.9.1 Guidelines for Surface Mount Footprints

Component footprint and reflow pad design for AVX capacitors.

The component footprint is defined as the maximum board area taken up by the terminators. The footprint dimensions are given by A, B, C and D in the diagram, which corresponds to W, max., A max., S min. and L max. for the component. The footprint is symmetric about the center lines.

The dimensions x, y and z should be kept to a minimum to reduce rotational tendencies while allowing for visual inspection of the component and its solder fillet.

Dimensions PS (Pad Separation) and PW (Pad Width) are calculated using dimensions x and z. Dimension y may vary, depending on whether reflow or wave soldering is to be performed.

For reflow soldering, dimensions PL (Pad Length), PW (Pad Width), and PSL (Pad Set Length) have been calculated. For wave soldering the pad width (PWw) is reduced to less than the termination width to minimize the amount of solder pick up while ensuring that a good joint can be produced.

**NOTE:** These recommendations (also in compliance with EIA) are guidelines only. With care and control, smaller footprints may be considered for reflow soldering.

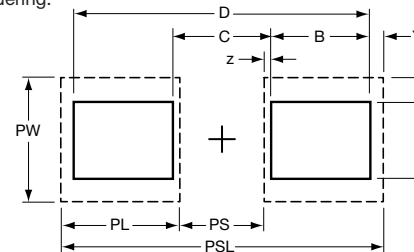

Nominal footprint and pad dimensions for each case size are given in the following tables:

### PAD DIMENSIONS: millimeters (inches)

Case Size	PSL	PL	PS	PW	PWw	
TAJ	A	3.80 (0.150)	1.40 (0.054)	1.00 (0.039)	1.80 (0.071)	0.90 (0.035)
	B	4.00 (0.157)	1.40 (0.054)	1.20 (0.047)	2.80 (0.110)	1.60 (0.063)
	C	6.50 (0.256)	2.00 (0.079)	2.50 (0.098)	2.80 (0.110)	1.60 (0.063)
	D	8.00 (0.315)	2.00 (0.079)	4.00 (0.157)	3.00 (0.119)	1.70 (0.068)
	E	8.00 (0.315)	2.00 (0.079)	4.00 (0.157)	3.00 (0.119)	1.70 (0.068)
TPS	R	2.70 (0.100)	0.95 (0.037)	0.80 (0.030)	1.60 (0.060)	0.80 (0.030)
	S	3.80 (0.150)	1.40 (0.054)	1.00 (0.039)	1.80 (0.071)	0.90 (0.035)
	T	4.00 (0.157)	1.40 (0.054)	1.20 (0.047)	2.80 (0.110)	1.60 (0.063)
	V	8.00 (0.315)	2.00 (0.079)	4.00 (0.157)	3.70 (0.145)	1.70 (0.068)
	W	6.50 (0.256)	2.00 (0.079)	2.50 (0.098)	2.80 (0.110)	1.60 (0.063)
TRJ	Y	8.00 (0.315)	2.00 (0.079)	4.00 (0.157)	3.00 (0.119)	1.70 (0.068)
	X	8.00 (0.315)	2.00 (0.079)	4.00 (0.157)	3.00 (0.119)	1.70 (0.068)
	P	2.70 (0.100)	0.95 (0.037)	0.80 (0.030)	1.60 (0.060)	0.80 (0.030)
	K	2.20 (0.087)	0.90 (0.035)	0.40 (0.016)	0.70 (0.028)	-
	L	2.80 (0.110)	1.10 (0.043)	0.60 (0.024)	1.00 (0.039)	-
THJ	R/H/U	3.20 (0.126)	1.30 (0.051)	0.60 (0.024)	1.50 (0.059)	-
	T	4.70 (0.185)	1.70 (0.070)	1.30 (0.051)	3.00 (0.118)	-
TPM & CWR11	X	4.20 (0.165)	1.60 (0.063)	1.00 (0.039)	1.60 (0.063)	-
	A	4.40 (0.173)	1.60 (0.063)	1.20 (0.047)	1.80 (0.071)	-
TAC	T	4.40 (0.173)	1.60 (0.063)	1.20 (0.047)	1.80 (0.071)	-
	T	4.70 (0.185)	1.70 (0.070)	1.30 (0.051)	3.00 (0.118)	-

**NOTE:** TAJ has a common footprint with TPS/TRJ/THJ/TPM & CWR11 Series.

### 5.10 PCB Cleaning

Ta chip capacitors are compatible with most PCB board cleaning systems.

If aqueous cleaning is performed, parts must be allowed to dry prior to test. In the event ultrasonics are used power levels should be less than 10 watts per/litre, and care must be taken to avoid vibrational nodes in the cleaning bath.

## SECTION 6 EPOXY FLAMMABILITY

EPOXY	UL RATING	OXYGEN INDEX
TAJ/TPS/TRJ/THJ/TPM/CWR11	UL94 V-0	35%

## SECTION 7 QUALIFICATION APPROVAL STATUS

DESCRIPTION	STYLE	SPECIFICATION
Surface mount capacitors	TAJ	CECC 30801 - 005 Issue 2 CECC 30801 - 011 Issue 1 MIL-C-55365/8 (CWR11)
	TAZ	MIL-C-55365/4 (CWR09)

## Material Data and Handling

This should be read in conjunction with the Product Datasheet. Failure to observe the ratings and the information on this sheet may result in a safety hazard.

### 1. Material Content

Solid Tantalum and OxiCap™ capacitors do not contain liquid hazardous materials.

The operating section contains:

Tantalum/Niobium	Graphite/carbon
Tantalum/Niobium oxide	Conducting paint/resins
Manganese dioxide	Fluoropolymers (not TAC)

The encapsulation contains:

TAA - solder, metal case, solder coated terminal wires, glass seal and plastic sleeve

TAC - epoxy molding compound, solder/tin coated terminal pads

TAJ, TPS, THJ, NOJ, NOS, NOM - epoxy molding compound, tin/solder coated terminal pads

TAP - solder, solder coated terminal wires, epoxy dipped resin

The epoxy resins may contain Antimony trioxide and Bromine compounds as fire retardants. The capacitors do not contain PBB or PBBO/PBBE. The solder alloys may contain lead.

### 2. Physical Form

These capacitors are physically small and are either rectangular with solderable terminal pads, or cylindrical or bead shaped with solderable terminal wires.

### 3. Intrinsic Properties

#### Operating

Both Tantalum and OxiCap™ capacitors are polarized devices and operate satisfactorily in the correct d.c. mode. They will withstand a limited application of reverse voltage as stated in the datasheets. However, a reverse application of the rated voltage will result in early short circuit failure and may result in fire or explosion. Consequential failure of other associated components in the circuit e.g. diodes, transformers, etc. may also occur. When operated in the correct polarity, a long period of satisfactory operation will be obtained but failure may occur for any of the following reasons:

- normal failure rate
- surge voltage exceeded
- reverse voltage exceeded
- temperature too high
- ripple rating exceeded

If this failure mode is a short circuit, the previous conditions apply. If the adjacent circuit impedance is low, voltage or current surges may exceed the power handling capability of the capacitor. For this reason capacitors in circuits of below 1Ω/V should be derated by minimum 50% for tantalum and 20% for OxiCap™. Precautions should be taken to prevent reverse voltage spikes. Where capacitors may be subjected to fast switched, low impedance source voltages, the manufacturers advice should be sought to determine the most suitable capacitors for such applications.

#### Non-operating

Both Tantalum and OxiCap™ capacitors contain no liquids or noxious gases to leak out. However, cracking or damage to the encapsulation may lead to premature failure due to ingress of material such as cleaning fluids or to stresses transmitted to the tantalum anode.

### 4. Fire Characteristics

#### Primary

Any component subject to abnormal power dissipation may

- self ignite
- become red hot
- break open or explode emitting flaming or red hot material, solid, molten or gaseous.

Fumes from burning components will vary in composition depending on the temperature, and should be considered to be hazardous, although fumes from a single component in a well ventilated area are unlikely to cause problems.

#### Secondary

Induced ignition may occur from an adjacent burning or red hot component. Epoxy resins used in the manufacture of capacitors give off noxious fumes when burning as stated above. Wherever possible, capacitors comply with the following: BS EN 60065

UL 492.60A/280

LOI (ASTM D2863-70) as stated in the datasheets.

### 5. Storage

Tantalum and OxiCap™ capacitors exhibit a very low random failure rate after long periods of storage and apart from this there are no known modes of failure under normal storage conditions. All capacitors will withstand any environmental conditions within their ratings for the periods given in the detail specifications. Storage for longer periods under high humidity conditions may affect the leakage current of resin protected capacitors. Solderability of solder coated surfaces may be affected by storage of excess of 2 years. Recommended storage conditions: Temperature: 15°C-35°C

Humidity: 45-75% RH

### 6. Disposal

Incineration of epoxy coated capacitors will cause emission of noxious fumes and metal cased capacitors may explode due to build up of internal gas pressure. Disposal by any other means normally involves no special hazards. Large quantities may have salvage value.

### 7. Unsafe Use

Most failures are of a passive nature and do not represent a safety hazard. A hazard may, however, arise if this failure causes a dangerous malfunction of the equipment in which the capacitor is employed. Circuits should be designed to fail safe under the normal modes of failure. The usual failure mode is an increase in leakage current or short circuit. Other possible modes are decrease of capacitance, increase in dissipation factor (and impedance) or an open-circuit. Operations outside the ratings quoted in the datasheets represents unsafe use.

### 8. Handling

Careless handling of the cut terminal leads could result in scratches and/or skin punctures. Hands should be washed after handling solder coated terminals before eating or smoking, to avoid ingestion of lead. Capacitors must be kept out of the reach of small children. Care must be taken to discharge capacitors before handling as capacitors may retain a residual charge even after equipment in which they are being used has been switched off. Sparks from the discharge could ignite a flammable vapor.

## Environmental Information

AVX has always sought to minimize the environmental impact of its manufacturing operations and of its capacitors supplied to customers throughout the world. We have a policy of preventing and minimizing waste streams during manufacture, and recycling materials wherever possible. We actively avoid or minimize environmentally hazardous materials in our production processes.

### 1. Material Content

For customers wishing to assess the environmental impact of AVX's capacitors contained in waste electrical and electronic equipment, the following information is provided:

Surface mount tantalum capacitors contain:

- Tantalum/Niobium and Tantalum/Niobium oxide
- Manganese dioxide
- Carbon/graphite
- Silver
- Nickel-iron alloy or Copper alloy depending on design (consult factory for details)
- Tin/Tin-lead alloy plating
- Polymers including fluorinated polymers
- Epoxy resin encapsulant

The encapsulant is made fire retardant to UL 94 V-0 by the inclusion of inert mineral filler, antimony trioxide and an organic bromine compound.

### 2. AVX capacitors do not contain any Polybrominated Biphenyl (PBB) or PBBE/PBBO, Mercury (Hg), Cadmium (Cd) or Hexavalent Chromium (Cr<sub>6+</sub>).

The approximate content of some materials is given in the table below for TAJ, TPS, THJ, TRJ, TPM, TCJ, TLJ, NOJ, NOS, and NOM series:

Tantalum				Niobium Oxide	
Case Size	Typical Weight (mg)	Antimony Trioxide (%)	Organic Bromine Compound (%)	Case Size	Typical Weight (mg)
A	31	1.2	0.9	A	26
B	72	1.0	0.7	B	56
C	194	0.9	0.7	C	154
D	373	0.8	0.6	D	279
E	531	1.0	0.7	E	399
V	681	1.1	0.8	V	510
P	15	1.1	0.8	P	12
R	10	1.0	0.7	R	9
S	19	1.3	1.0	S	17
T	35	1.1	0.9	T	32
W	97	1.1	0.8	W	82
X	158	1.1	0.8	X	127
Y	237	1.2	0.9	Y	182

NOJ, NOS, NOM series does not contain lead, antimony trioxide or organic bromine compound.

TAC series does not contain lead, antimony trioxide or organic bromine compound.

The specific weight of other materials contained in the various case sizes is available on written request. The component

packing tape is either recyclable Polycarbonate or PVC (depending on case size), and the sealing tape is a laminate of halogen-free polymers. The reels are recyclable polystyrene, and marked with the recycling symbol. The reels are over-packed in recyclable fiber board boxes. None of the packing contains heavy metals.

### 3. Lead

Parts supplied today are electroplated over the terminal contact area with 100% Tin (Sn). Older products may contain lead comprising much less than 0.2% of the component weight.

### 4. Fire Retardants

Currently the only known way of supplying a fire retardant encapsulant which meets all our performance requirements, is to incorporate antimony trioxide and an organic bromine compound. These materials are commonly used in many plastic items in the home and industry. We expect to be able to offer an alternative fire retardant encapsulant, free of these materials, by 2005. A combustible encapsulant free of these materials could be supplied today, but AVX believes that the health and safety benefits of using these materials to provide fire retardancy during the life of the product, far outweigh the possible risks to the environment and human health.

### 5. Nickel alloy

It is intended that all case sizes will be made with a high copper alloy termination. Some case sizes are supplied now with this termination, and other sizes may be available. Please contact AVX if you prefer this.

### 6. Recycling

Surface mount Tantalum and OxiCap™ capacitors have a very long service life with no known wear-out mechanism, and a low failure rate. However, parts contained in equipment which is of no further use will have some residual value mainly because of the Tantalum metal or niobium oxide contained. This can be recovered and recycled by specialist companies. The silver and nickel or copper alloy will also have some value. Please contact AVX if you require assistance with the disposal of parts. Packaging can be recycled as described above.

### 7. Disposal

Surface mount Tantalum and OxiCap™ capacitors do not contain any liquids and no part of the devices is normally soluble in water at neutral pH values. Incineration will cause the emission of noxious fumes and is not recommended except by specialists. Landfill may be considered for disposal, bearing in mind the small lead content.

Under certain extreme physical conditions it is possible to generate ignition of Tantalum, Niobium and Niobium oxide capacitors. These physical conditions relate to high-speed impact and although not considered to be a normal operating occurrence may occur as a method of material(s) recovery. Therefore appropriate safeguards procedures and methodologies need to be adopted to eliminate any risks of material ignition.

## Environmental Information

For further information, please contact your local AVX sales office or representative.

### 8. RoHS Compliance

AVX can declare that we do not add any materials from the list below to series TAJ, TPS, THJ, TRJ, TPM, NOJ, NOS, and NOM during production, so they are not contained in any significant level.

Substances	Taping Code	RoHS Compliance	
Heavy Metals	Cadmium and cadmium compounds	All	YES
	Lead and lead compounds	A,B,Y,P	YES
		R,S	YES, since production date 1/1/04
	K,H	NO	
Mercury and mercury compounds	All	YES	
Hexavalent chromium compounds	All	YES	
Chlorinated organic compounds	Polychlorinated biphenyls (PCB)	All	YES
	Polychlorinated naphthalenes (PCN)	All	YES
	Chlorinated paraffins (CP)	All	YES
	Mirex (Perchlordecone)	All	YES
Brominated organic compounds	Polybrominated biphenyls (PBB)	All	YES
	Polybrominated diphenylethers (PBDE)	All	YES
Organic tin compounds	All	YES	
Asbestos	All	YES	
Azo compounds	All	YES	
Formaldehyde	All	YES	
Polyvinyl chloride (PVC) and PVC blends	All	YES	
Terpentyne	All	YES	

# TAJ, TPS, TRJ, THJ, TPM, TAC, TPC, TLJ, TCJ and TMC Series – Tape and Reel Packaging



Tape and reel packaging for automatic component placement. Please enter required Suffix on order. Bulk packaging is not available.

## TAPE SPECIFICATION

Tape dimensions comply to EIA 481-1 Dimensions A<sub>0</sub> and B<sub>0</sub> of the pocket and the tape thickness, K, are dependent on the component size. Tape materials do not affect component solderability during storage. Carrier Tape Thickness <0.4mm.

## TAPING SUFFIX TABLE TAJ, TPS, TRJ, THJ, TPM, TLJ and TCJ

Case Size	Tape width mm	P mm	100mm (4") reel		180mm (7") reel		330mm (13") reel		180mm (7") reel & Gold Termination	
			Suffix	Qty.	Suffix	Qty.	Suffix	Qty.	Suffix	Qty.
A	8	4			R	2000	S	8000	A	2000
B	8	4			R	2000	S	8000	A	2000
C	12	8			R	500	S	3000	A	500
D	12	8			R	500	S	2500	A	500
E	12	8			R	400	S	1500	A	400
V	12	8			R	400	S	1500	A	400
R	8	4			R	2500	S	10000	A	2500
P	8	4			R	2500	S	10000	A	2500
S	8	4			R	2500	S	10000	A	2500
T	8	4			R	2500	S	10000	A	2500
W	12	8			R	1000	S	5000	A	1000
Y	12	8			R	1000	S	4000	A	1000
X	12	8			R	1000	S	5000	A	1000

## TAPING SUFFIX TABLE TAC and TPC

Case Size	Tape width mm	P mm	100mm (4") reel Tin Termination		180mm (7") reel Tin Termination		100mm (4") reel & Gold Termination		180mm (7") reel & 100% Gold Termination	
			Suffix	Qty.	Suffix	Qty.	Suffix	Qty.	Suffix	Qty.
K	8	2	QTA	1000	PTA	10,000				
L	8	4	XTA	500	RTA	3,500	FTA	500	ATA	3,500
R	8	4	XTA	500	RTA	2,500	FTA	500	ATA	2,500
H	8	4	XTA	500	RTA	3,500	FTA	500	ATA	3,500
U	8	4	XTA	500	RTA	3,500	FTA	500	ATA	3,500
X	8	4	XTA	500	RTA	2,000	FTA	500	ATA	2,000
A	8	4	XTA	500	RTA	2,000	FTA	500	ATA	2,000
T	8	4	XTA	500	RTA	2,500	-	-	-	-

## PLASTIC TAPE DIMENSIONS TAJ, TPS, TRJ, THJ, TPM, TLJ and TCJ

Case	A0±0.10	B0±0.10	K±0.10	W±0.30	E±0.10	F±0.05	G min.	P±0.10	P2±0.05	P0±0.10	D0 <sup>+0.20</sup> <sub>-0.00</sub>	D1 <sup>+0.20</sup> <sub>-0.00</sub>
A	1.83	3.57	1.87	8.00	1.75	3.50	0.75	4.00	2.00	4.00	1.50	1.00
B	3.15	3.77	2.22	8.00	1.75	3.50	0.75	4.00	2.00	4.00	1.50	1.00
C	3.45	6.40	2.92	12.0	1.75	5.50	0.75	8.00	2.00	4.00	1.50	1.50
D	4.48	7.62	3.22	12.0	1.75	5.50	0.75	8.00	2.00	4.00	1.50	1.50
E	4.50	7.50	4.50	12.0	1.75	5.50	0.75	8.00	2.00	4.00	1.50	1.50
V	6.43	7.44	3.84	12.0	1.75	5.50	0.75	8.00	2.00	4.00	1.50	1.50
W	3.57	6.40	1.65	12.0	1.75	5.50	0.75	8.00	2.00	4.00	1.50	1.50
X	4.67	7.62	1.65	12.0	1.75	5.50	0.75	8.00	2.00	4.00	1.50	1.50
Y	4.67	7.62	2.15	12.0	1.75	5.50	0.75	8.00	2.00	4.00	1.50	1.50
R	1.65	2.45	1.30	8.00	1.75	3.50	0.75	4.00	2.00	4.00	1.50	1.00
P	1.65	2.45	1.60	8.00	1.75	3.50	0.75	4.00	2.00	4.00	1.50	1.00
S	1.95	3.55	1.30	8.00	1.75	3.50	0.75	4.00	2.00	4.00	1.50	1.00
T	3.20	3.80	1.30	8.00	1.75	3.50	0.75	4.00	2.00	4.00	1.50	1.00

## PLASTIC TAPE DIMENSIONS TAC, TPC and TMC

Plastic	Case	A0+0.025	B0±0.05	W±0.30	E±0.10	F±0.05	P±0.10	P2±0.05	P0±0.10	D <sup>+0.10</sup> <sub>-0.00</sub>	D1 <sup>+0.10</sup> <sub>-0.00</sub>	K±0.05
	L	1.025	1.95	8	1.75	3.5	4	2	4	1.5	0.8	1.1
Plastic	Case	A0+0.05	B0±0.10	W±0.30	E±0.10	F±0.05	P±0.10	P2±0.05	P0±0.10	D <sup>+0.10</sup> <sub>-0.00</sub>	D1 Min.	K±0.05
	R	1.7	2.45	8	1.75	3.5	4	2	4	1.5	1.0	1.7
	H	1.7	2.45	8	1.75	3.5	4	2	4	1.5	1.0	1.1
	U	1.7	2.45	8	1.75	3.5	4	2	4	1.5	1.0	0.8
Plastic	Case	A0+0.10	B0±0.10	W±0.30	E±0.10	F±0.05	P±0.10	P2±0.05	P0±0.10	D <sup>+0.20</sup> <sub>-0.00</sub>	D1 Min.	K±0.10
	A/X	1.83	3.57	8	1.75	3.5	4	2	4	1.5	1.0	1.87
	T	3.20	3.80	8	1.75	3.5	4	4	2	4	1.50	1.0

# TAJ, TPS, TRJ, THJ, TPM, TAC, TPC, TLJ, TCJ and TMC Series – Tape and Reel Packaging



## REEL DIMENSIONS

Reel Size	Tape	A	B	C	W	t
180mm (7")	12mm	178±2.00	50 min	13.0±0.50	12.4+1.5/-0	1.50±0.50
180mm (7")	8mm	178±2.00	50 min	13.0±0.50	8.4+1.5/-0	1.50±0.50
330mm (13")	12mm	328±2.00	50 min	13.0±0.50	12.4+1.5/-0	1.50±0.50
330mm (13")	8mm	328±2.00	50 min	13.0±0.50	8.4+1.5/-0	1.50±0.50
108mm (4.25")	8mm	108±2.00		13.0±0.50	8.4+1.5/-0	1.50±0.50

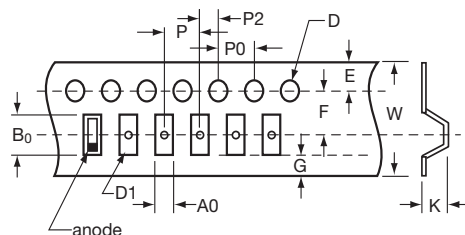
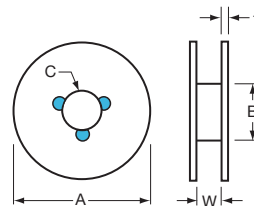

## COVER TAPE NOMINAL DIMENSIONS

Thickness: 75µm  
 Width of tape: 5.5mm (8mm tape)  
 9.5mm (12mm tape)

## For TAC Range Only (Paper Tape)

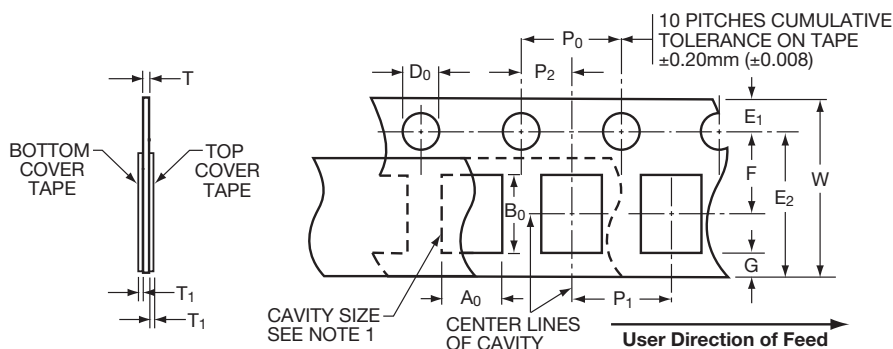

	A <sub>0</sub>	B <sub>0</sub>	W	E	F	P <sub>1</sub>	P <sub>2</sub>	P <sub>0</sub>	D <sub>0</sub>	E <sub>2</sub>	T
	+0.1 -0.05	+0.05 -0.05	±.20	±0.10	±0.05	±0.05	±0.05	±0.1	-0.1 -0.0	Min	±0.05
<b>K</b>	0.75	1.35	8.0	1.75	3.5	2.0	2.0	4.0	1.5	6.25	0.75



# TAZ, CWR09, CWR11 and CWR19 Series



## Tape and Reel Packaging

Solid Tantalum Chip TAZ Tape and reel packaging for automatic component placement.  
Please enter required Suffix on order. Bulk packaging is standard.

### TAZ TAPING SUFFIX TABLE

Case Size reference	Tape width mm	P mm	7" (180mm) reel		13" reel (330mm) reel	
			Suffix	Qty.	Suffix	Qty.
A	8	4	R	2500	S	9000
B	12	4	R	2500	S	9000
D	12	4	R	2500	S	8000
E	12	4	R	2500	S	8000
F	12	8	R	1000	S	3000
G	12	8	R	500	S	2500
H	12	8	R	500	S	2500

Total Tape Thickness — K max	
Case size reference	TAZ Millimeters (Inches) DIM
A	2.0 (0.079)
B	4.0 (0.157)
D	4.0 (0.157)
E	4.0 (0.157)
F	4.0 (0.157)
G	4.0 (0.157)
H	4.0 (0.157)

Code	8mm Tape		12mm Tape	
P*	4±0.1 or 8±0.1	(0.157±0.004) (0.315±0.004)	4±0.1 or 8±0.1	(0.157±0.004) (0.315±0.004)
G	0.75 min	(0.03 min)	0.75 min	(0.03 min)
F	3.5±0.05	(0.138±0.002)	5.5±0.05	(0.22±0.002)
E	1.75±0.1	(0.069±0.004)	1.75±0.1	(0.069±0.004)
W	8±0.3	(0.315±0.012)	12±0.3	(0.472±0.012)
P <sub>2</sub>	2±0.05	(0.079±0.002)	2±0.05	(0.079±0.002)
P <sub>0</sub>	4±0.1	(0.157±0.004)	4±0.1	(0.157±0.004)
D	1.5±0.1 -0	(0.059±0.004) (-0)	1.5±0.1 -0	(0.059±0.004) (-0)
D <sub>1</sub>	1.0 min	(0.039 min)	1.5 min	(0.059 min)

\*See taping suffix tables for actual P dimension (component pitch).

### TAPE SPECIFICATION

Tape dimensions comply to EIA RS 481 A  
Dimensions A<sub>0</sub> and B<sub>0</sub> of the pocket and the tape thickness, K, are dependent on the component size.

Tape materials do not affect component solderability during storage.

Carrier Tape Thickness <0.4mm

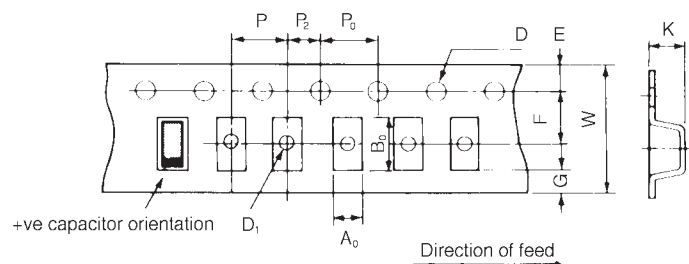

# TAJ, TRJ, THJ, TPS, TPM, NOJ, NOS, NOM, TAC, TPC, TMC, TCJ and TLJ



## Marking

For TAJ, TPS & THJ, the positive end of body has videocon readable polarity marking as shown in the diagram. Bodies are marked by indelible laser marking on top surface with

capacitance value, voltage, date of manufacture and batch ID number. R and P case is an exception due to small size in which only the voltage and capacitance values are printed.

Year	Year Code	Year	Year Code
2000	M	2004	S
2001	N	2005	T
2002	P	2006	U
2003	R	2007	Y

Voltage Code	Rated Voltage at 85°C	Voltage Code	Rated Voltage at 85°C
F	2.5	D	20
G	4	E	25
J	6.3	V	35
A	10	T	50
C	16		

### TAJ, TRJ, TPS, TPM & TCJ – A, B, C, D, E, S, T, V, W, Y and X CASE:

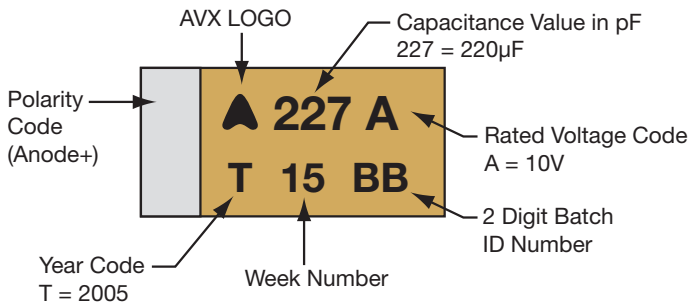

### TAJ – R and P CASE:

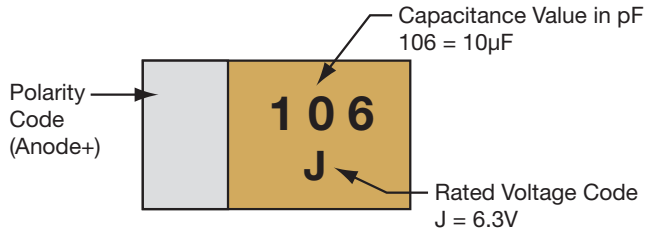

### THJ – A, B, C, D and E CASE:

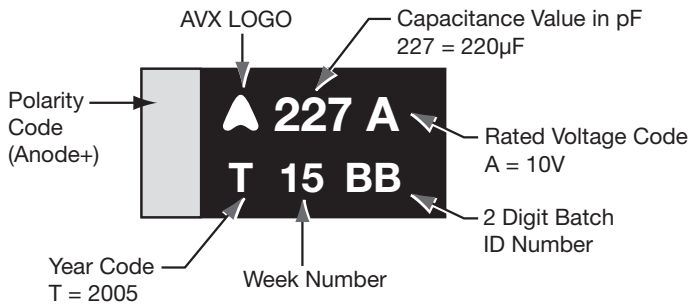

### TAC, TPC, TMC – ALL CASE SIZES

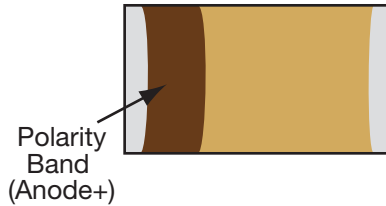

### TCJ – A, B CASE:

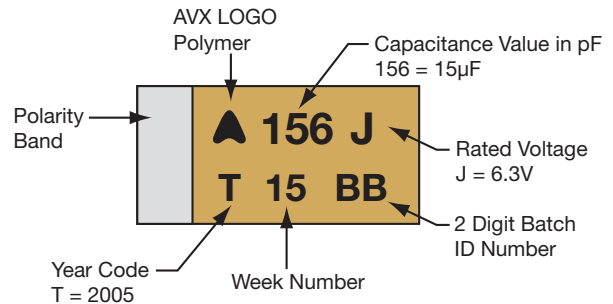

### NOJ, NOS, NOM – A, B, C, D, E and V CASE:

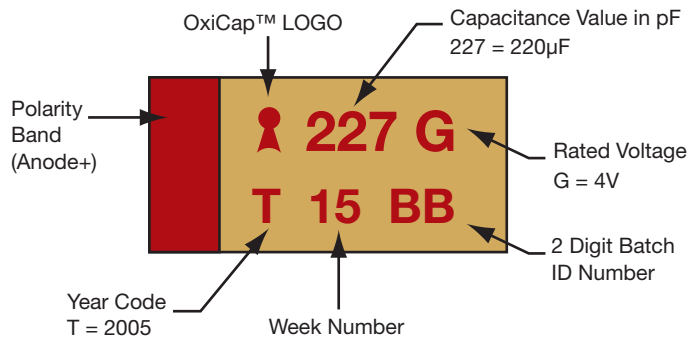

### TLJ – A, B, T, W CASE:

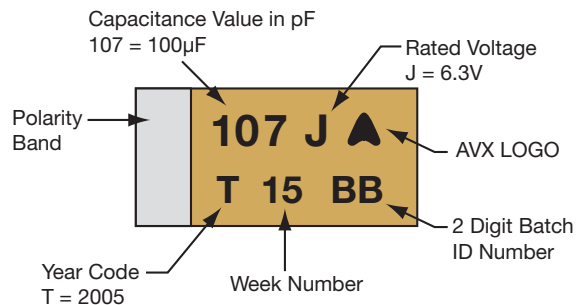

# TAP Technical Summary and Application Guidelines



## SECTION 1: ELECTRICAL CHARACTERISTICS AND EXPLANATION OF TERMS

### 1.1 CAPACITANCE

#### 1.1.1 Rated capacitance ( $C_R$ )

This is the nominal rated capacitance. For tantalum capacitors it is measured as the capacitance of the equivalent series circuit at 20°C in a measuring bridge supplied by a 120 Hz source free of harmonics with 2.2V DC bias max.

#### 1.1.2 Temperature dependence on the capacitance

The capacitance of a tantalum capacitor varies with temperature. This variation itself is dependent to a small extent on the rated voltage and capacitor size. See graph below for typical capacitance changes with temperature.

Typical Capacitance vs. Temperature

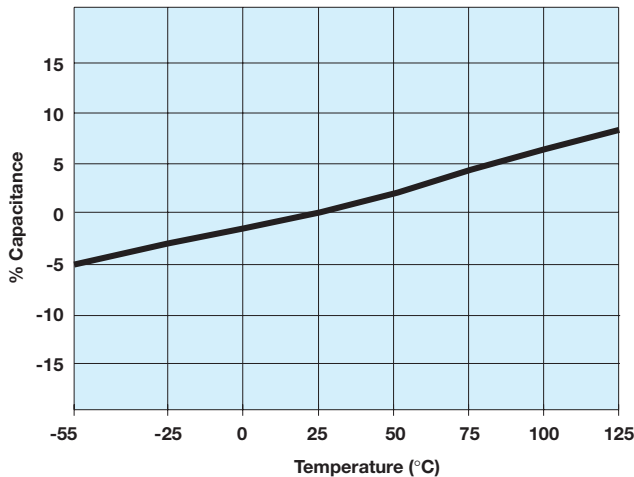

#### 1.1.3 Capacitance tolerance

This is the permissible variation of the actual value of the capacitance from the rated value.

#### 1.1.4 Frequency dependence of the capacitance

The effective capacitance decreases as frequency increases. Beyond 100 kHz the capacitance continues to drop until resonance is reached (typically between 0.5-5 MHz depending on the rating). Beyond this the device becomes inductive.

Typical Curve Capacitance vs. Frequency

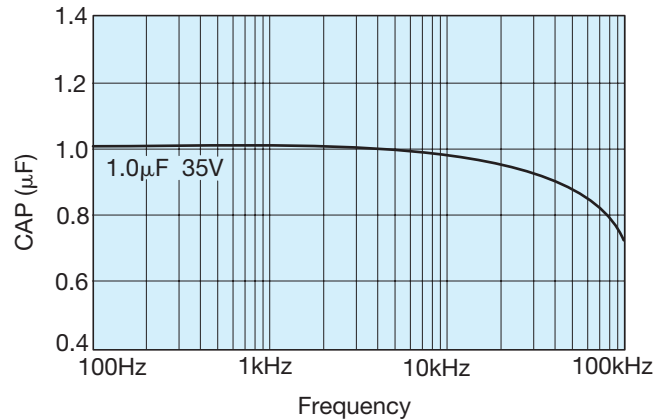

### 1.2 VOLTAGE

#### 1.2.1 Rated DC voltage ( $V_R$ )

This is the rated DC voltage for continuous operation up to +85°C.

#### 1.2.2 Category voltage ( $V_C$ )

This is the maximum voltage that may be applied continuously to a capacitor. It is equal to the rated voltage up to +85°C, beyond which it is subject to a linear derating, to 2/3  $V_R$  at 125°C.

#### 1.2.3 Surge voltage ( $V_S$ )

This is the highest voltage that may be applied to a capacitor for short periods of time. The surge voltage may be applied up to 10 times in an hour for periods of up to 30 seconds at a time. The surge voltage must not be used as a parameter in the design of circuits in which, in the normal course of operation, the capacitor is periodically charged and discharged.

Category Voltage vs. Temperature

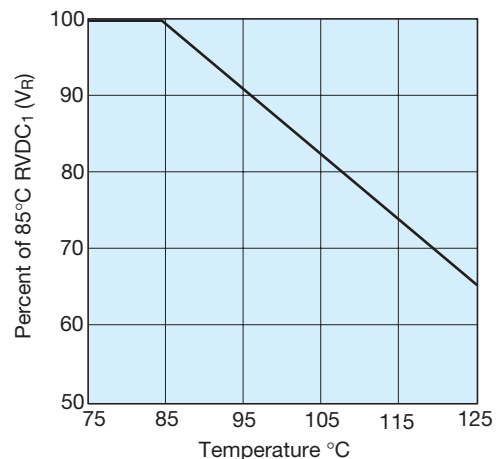

# TAP Technical Summary and Application Guidelines



85°C		125°C	
Rated Voltage (V DC)	Surge Voltage (V DC)	Category Voltage (V DC)	Surge Voltage (V DC)
2	2.6	1.3	1.7
3	4	2	2.6
4	5.2	2.6	3.4
6.3	8	4	5
10	13	6.3	9
16	20	10	12
20	26	13	16
25	33	16	21
35	46	23	28
50	65	33	40

## 1.2.4 Effect of surges

The solid Tantalum capacitor has a limited ability to withstand surges (15% to 30% of rated voltage). This is in common with all other electrolytic capacitors and is due to the fact that they operate under very high electrical stress within the oxide layer. In the case of 'solid' electrolytic capacitors this is further complicated by the limited self healing ability of the manganese dioxide semiconductor.

It is important to ensure that the voltage across the terminals of the capacitor does not exceed the surge voltage rating at any time. This is particularly so in low impedance circuits where the capacitor is likely to be subjected to the full impact of surges, especially in low inductance applications. Even an extremely short duration spike is likely to cause damage. In such situations it will be necessary to use a higher voltage rating.

## 1.3 DISSIPATION FACTOR AND TANGENT OF LOSS ANGLE (TAN δ)

### 1.3.1 Dissipation factor (DF)

Dissipation factor is the measurement of the tangent of the loss angle (Tan δ) expressed as a percentage.

The measurement of DF is carried out at +25°C and 120 Hz with 2.2V DC bias max. with an AC voltage free of harmonics. The value of DF is temperature and frequency dependent.

### 1.3.2 Tangent of loss angle (Tan δ)

This is a measure of the energy loss in the capacitor. It is expressed as Tan δ and is the power loss of the capacitor divided by its reactive power at a sinusoidal voltage of specified frequency. (Terms also used are power factor, loss factor and dielectric loss, Cos (90 - δ) is the true power factor.) The measurement of Tan δ is carried out at +20°C and 120 Hz with 2.2V DC bias max. with an AC voltage free of harmonics.

### 1.2.5 Reverse voltage and non-polar operation

The reverse voltage ratings are designed to cover exceptional conditions of small level excursions into incorrect polarity. The values quoted are not intended to cover continuous reverse operation.

The peak reverse voltage applied to the capacitor must not exceed:

- 10% of rated DC working voltage to a maximum of 1V at 25°C

- 3% of rated DC working voltage to a maximum of 0.5V at 85°C

- 1% of category DC working voltage to a maximum of 0.1V at 125°C

### 1.2.6 Non-polar operation

If the higher reverse voltages are essential, then two capacitors, each of twice the required capacitance and of equal tolerance and rated voltage, should be connected in a back-to-back configuration, i.e., both anodes or both cathodes joined together. This is necessary in order to avoid a reduction in life expectancy.

### 1.2.7 Superimposed AC voltage (V<sub>rms</sub>) - Ripple Voltage

This is the maximum RMS alternating voltage, superimposed on a DC voltage, that may be applied to a capacitor. The sum of the DC voltage and the surge value of the superimposed AC voltage must not exceed the category voltage, V<sub>c</sub>. Full details are given in Section 2.

### 1.2.8 Voltage derating

Refer to section 3.2 (pages 128-129) for the effect of voltage derating on reliability.

### 1.3.3 Frequency dependence of dissipation factor

Dissipation Factor increases with frequency as shown in the typical curves below.

Typical Curve-Dissipation Factor vs. Frequency

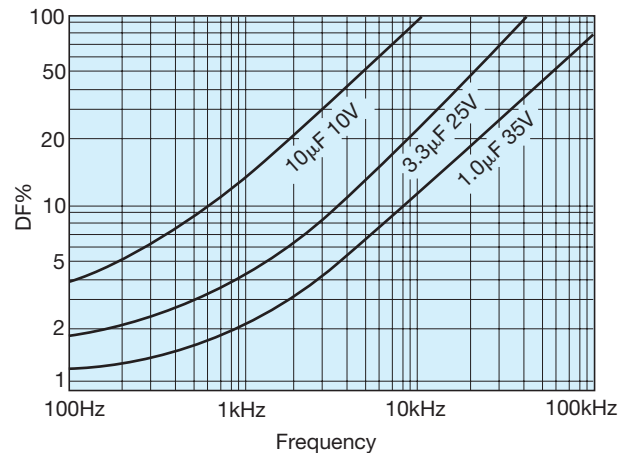

# TAP Technical Summary and Application Guidelines



## 1.3.4 Temperature dependence of dissipation factor

Dissipation factor varies with temperature as the typical curves show to the right. For maximum limits please refer to ratings tables.

## Typical Curves-Dissipation Factor vs. Temperature

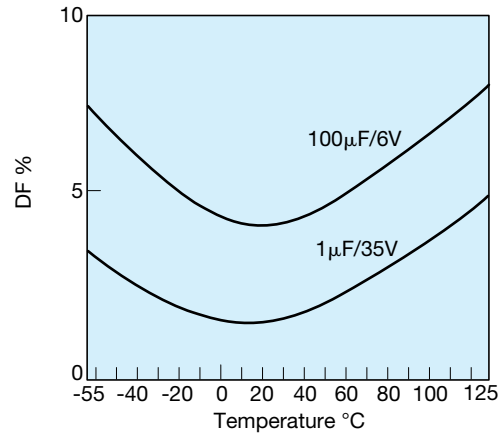

## 1.4 IMPEDANCE, (Z) AND EQUIVALENT SERIES RESISTANCE (ESR)

### 1.4.1 Impedance, Z

This is the ratio of voltage to current at a specified frequency. Three factors contribute to the impedance of a tantalum capacitor; the resistance of the semiconducting layer, the capacitance, and the inductance of the electrodes and leads.

At high frequencies the inductance of the leads becomes a limiting factor. The temperature and frequency behavior of these three factors of impedance determine the behavior of the impedance Z. The impedance is measured at 25°C and 100 kHz.

### 1.4.2 Equivalent series resistance, ESR

Resistance losses occur in all practical forms of capacitors. These are made up from several different mechanisms, including resistance in components and contacts, viscous forces within the dielectric, and defects producing bypass current paths. To express the effect of these losses they are considered as the ESR of the capacitor. The ESR is frequency dependent. The ESR can be found by using the relationship:

$$ESR = \frac{\tan \delta}{2\pi f C}$$

where f is the frequency in Hz, and C is the capacitance in farads. The ESR is measured at 25°C and 100 kHz.

ESR is one of the contributing factors to impedance, and at high frequencies (100 kHz and above) is the dominant factor, so that ESR and impedance become almost identical, impedance being marginally higher.

### 1.4.3 Frequency dependence of impedance and ESR

ESR and impedance both increase with decreasing frequency. At lower frequencies the values diverge as the extra contributions to impedance (resistance of the semiconducting layer, etc.) become more significant. Beyond 1 MHz (and beyond the resonant point of the capacitor) impedance again increases due to induction.

## Frequency Dependence of Impedance and ESR

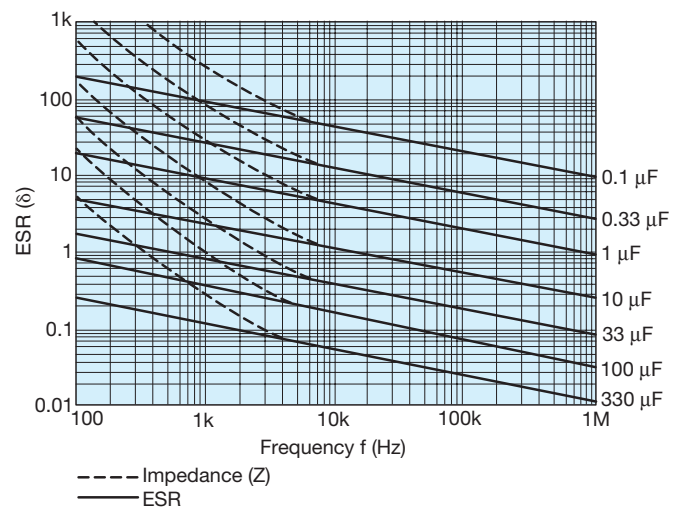

# TAP Technical Summary and Application Guidelines



## 1.4.4 Temperature dependence of the impedance and ESR

At 100 kHz, impedance and ESR behave identically and decrease with increasing temperature as the typical curves show. For maximum limits at high and low temperatures, please refer to graph opposite.

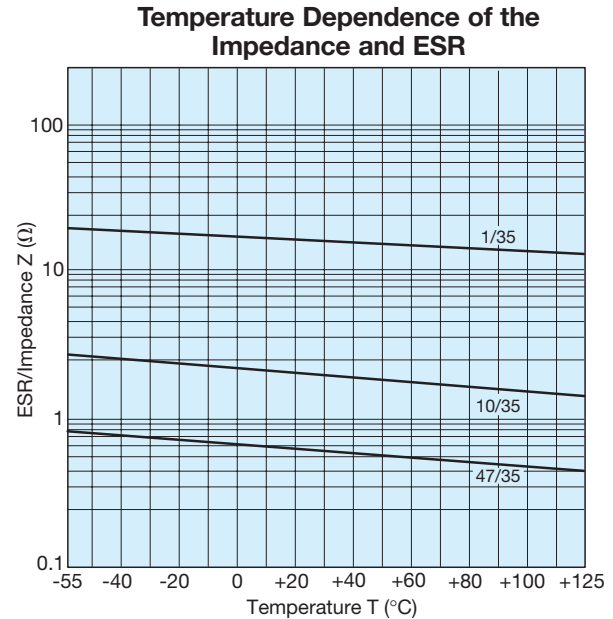

## 1.5 DC LEAKAGE CURRENT (DCL)

### 1.5.1 Leakage current (DCL)

The leakage current is dependent on the voltage applied, the time, and the capacitor temperature. It is measured at +25°C with the rated voltage applied. A protective resistance of 1000Ω is connected in series with the capacitor in the measuring circuit.

Three minutes after application of the rated voltage the leakage current must not exceed the maximum values indicated in the ratings table. Reforming is unnecessary even after prolonged periods without the application of voltage.

### 1.5.2 Temperature dependence of the leakage current

The leakage current increases with higher temperatures, typical values are shown in the graph.

For operation between 85°C and 125°C, the maximum working voltage must be derated and can be found from the following formula.

$$V_{\max} = \left(1 - \frac{T-85}{120}\right) \times V_R \text{ volts}$$

where T is the required operating temperature. Maximum limits are given in rating tables.

### 1.5.3 Voltage dependence of the leakage current

The leakage current drops rapidly below the value corresponding to the rated voltage  $V_R$  when reduced voltages are applied. The effect of voltage derating on the leakage current is shown in the graph.

This will also give a significant increase in reliability for any application. See Section 3 (pages 127-129) for details.

### 1.5.4 Ripple current

The maximum ripple current allowance can be calculated from the power dissipation limits for a given temperature rise above ambient. Please refer to Section 2 (page 126) for details.

## Temperature Dependence of the Leakage Current for a Typical Component

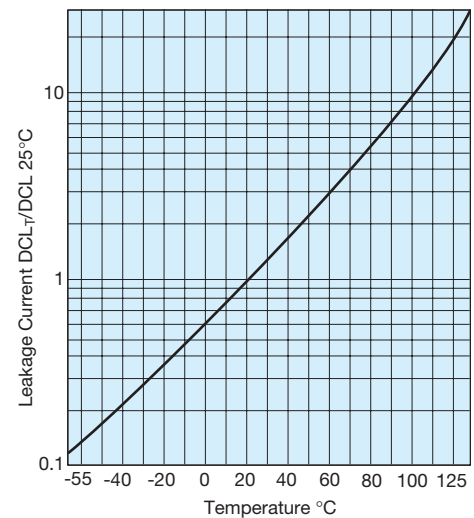

## Effect of Voltage Derating on Leakage Current

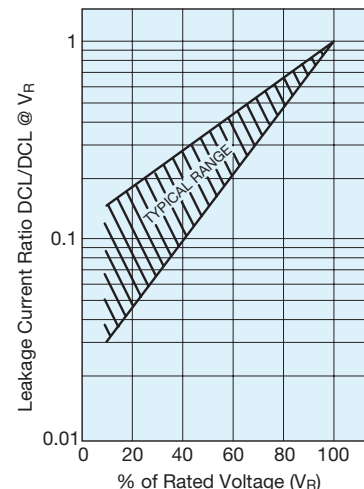

# TAP Technical Summary and Application Guidelines



## SECTION 2: AC OPERATION — RIPPLE VOLTAGE AND RIPPLE CURRENT

### 2.1 RIPPLE RATINGS (AC)

In an AC application heat is generated within the capacitor by both the AC component of the signal (which will depend upon signal form, amplitude and frequency), and by the DC leakage. For practical purposes the second factor is insignificant. The actual power dissipated in the capacitor is calculated using the formula:

$$P = I^2 R = \frac{E^2 R}{Z^2}$$

- I = rms ripple current, amperes
- R = equivalent series resistance, ohms
- E = rms ripple voltage, volts
- P = power dissipated, watts
- Z = impedance, ohms, at frequency under consideration

Using this formula it is possible to calculate the maximum AC ripple current and voltage permissible for a particular application.

### 2.2 MAXIMUM AC RIPPLE VOLTAGE (E<sub>max</sub>)

From the previous equation:

$$E_{(max)} = Z \sqrt{\frac{P_{max}}{R}}$$

where P<sub>max</sub> is the maximum permissible ripple voltage as listed for the product under consideration (see table).

However, care must be taken to ensure that:

1. The DC working voltage of the capacitor must not be exceeded by the sum of the positive peak of the applied AC voltage and the DC bias voltage.
2. The sum of the applied DC bias voltage and the negative peak of the AC voltage must not allow a voltage reversal in excess of that defined in the sector, 'Reverse Voltage'.

### 2.3 MAXIMUM PERMISSIBLE POWER DISSIPATION (WATTS) @ 25°C

The maximum power dissipation at 25°C has been calculated for the various series and are shown in Section 2.4, together with temperature derating factors up to 125°C.

For leaded components the values are calculated for parts supported in air by their leads (free space dissipation).

The ripple ratings are set by defining the maximum temperature rise to be allowed under worst case conditions, i.e., with resistive losses at their maximum limit. This differential is normally 10°C at room temperature dropping to 2°C at 125°C. In application circuit layout, thermal management, available ventilation, and signal waveform may significantly

affect the values quoted below. It is recommended that temperature measurements are made on devices during operating conditions to ensure that the temperature differential between the device and the ambient temperature is less than 10°C up to 85°C and less than 2°C between 85°C and 125°C. Derating factors for temperatures above 25°C are also shown below. The maximum permissible proven dissipation should be multiplied by the appropriate derating factor.

For certain applications, e.g., power supply filtering, it may be desirable to obtain a screened level of ESR to enable higher ripple currents to be handled. Please contact our applications desk for information.

### 2.4 POWER DISSIPATION RATINGS (IN FREE AIR)

#### TAR – Molded Axial

Case size	Max. power dissipation (W)	Temperature derating factors	
		Temp. °C	Factor
Q	0.065	+25	1.0
R	0.075	+85	0.6
S	0.09	+125	0.4
W	0.105		

#### TAA – Hermetically Sealed Axial

Case size	Max. power dissipation (W)	Temperature derating factors	
		Temp. °C	Factor
A	0.09	+20	1.0
B	0.10	+85	0.9
C	0.125	+125	0.4
D	0.18		

#### TAP – Resin Dipped Radial

Case size	Max. power dissipation (W)	Temperature derating factors	
		Temp. °C	Factor
A	0.045	+25	1.0
B	0.05	+85	0.4
C	0.055	+125	0.09
D	0.06		
E	0.065		
F	0.075		
G	0.08		
H	0.085		
J	0.09		
K	0.1		
L	0.11		
M/N	0.12		
P	0.13		
R	0.14		



# TAP Technical Summary and Application Guidelines



## SECTION 3: RELIABILITY AND CALCULATION OF FAILURE RATE

### 3.1 STEADY-STATE

Tantalum Dielectric has essentially no wear out mechanism and in certain circumstances is capable of limited self healing, random failures can occur in operation. The failure rate of Tantalum capacitors will decrease with time and not increase as with other electrolytic capacitors and other electronic components.

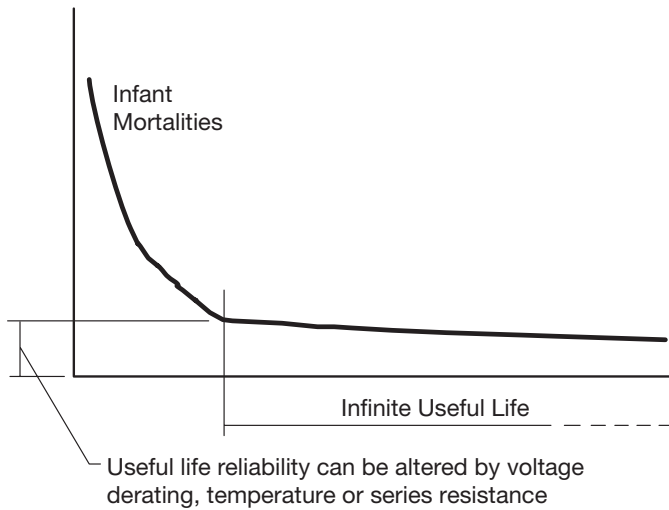

Figure 1. Tantalum reliability curve.

The useful life reliability of the Tantalum capacitor is affected by three factors. The equation from which the failure rate can be calculated is:

$$F = F_U \times F_T \times F_R \times F_B$$

where  $F_U$  is a correction factor due to operating voltage/voltage derating

$F_T$  is a correction factor due to operating temperature

$F_R$  is a correction factor due to circuit series resistance

$F_B$  is the basic failure rate level. For standard leaded Tantalum product this is 1%/1000hours

#### Operating voltage/voltage derating

If a capacitor with a higher voltage rating than the maximum line voltage is used, then the operating reliability will be improved. This is known as voltage derating. The graph, Figure 2, shows the relationship between voltage derating (the ratio between applied and rated voltage) and the failure rate. The graph gives the correction factor  $F_U$  for any operating voltage.

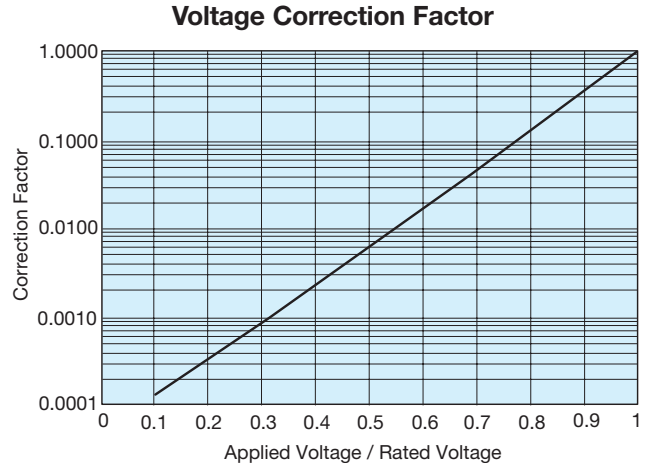

Figure 2. Correction factor to failure rate  $F$  for voltage derating of a typical component (60% con. level).

#### Operating temperature

If the operating temperature is below the rated temperature for the capacitor then the operating reliability will be improved as shown in Figure 3. This graph gives a correction factor  $F_T$  for any temperature of operation.

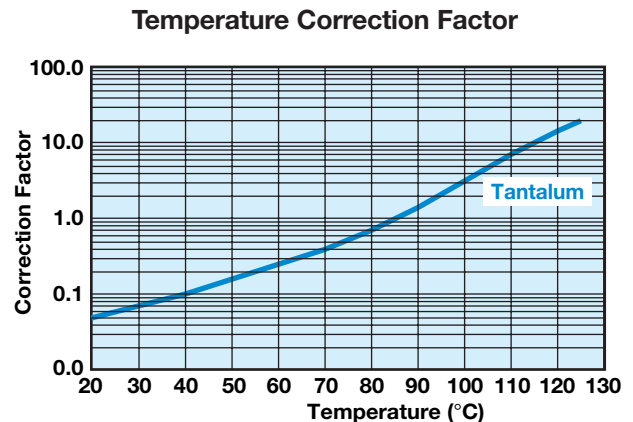

Figure 3. Correction factor to failure rate  $F$  for ambient temperature  $T$  for typical component (60% con. level).



# TAP Technical Summary and Application Guidelines



## Circuit Impedance

All solid tantalum capacitors require current limiting resistance to protect the dielectric from surges. A series resistor is recommended for this purpose. A lower circuit impedance may cause an increase in failure rate, especially at temperatures higher than 20°C. An inductive low impedance circuit may apply voltage surges to the capacitor and similarly a non-inductive circuit may apply current surges to the capacitor, causing localized over-heating and failure. The recommended impedance is 1Ω per volt. Where this is not feasible, equivalent voltage derating should be used (See MIL HANDBOOK 217E). Table I shows the correction factor,  $F_R$ , for increasing series resistance.

**Table I: Circuit Impedance**

Correction factor to failure rate  $F$  for series resistance  $R$  on basic failure rate  $F_B$  for a typical component (60% con. level).

Circuit Resistance ohms/volt	FR
3.0	0.07
2.0	0.1
1.0	0.2
0.8	0.3
0.6	0.4
0.4	0.6
0.2	0.8
0.1	1.0

## Example calculation

Consider a 12 volt power line. The designer needs about 10μF of capacitance to act as a decoupling capacitor near a video bandwidth amplifier. Thus the circuit impedance will be limited only by the output impedance of the boards power unit and the track resistance. Let us assume it to be about 2 Ohms minimum, i.e., 0.167 Ohms/Volt. The operating temperature range is -25°C to +85°C. If a 10μF 16 Volt capacitor was designed-in, the operating failure rate would be as follows:

- a)  $F_T = 0.8 @ 85^\circ\text{C}$
- b)  $F_R = 0.7 @ 0.167 \text{ Ohms/Volt}$
- c)  $F_U = 0.17 @ \text{applied voltage/rated voltage} = 75\%$

Thus  $F_B = 0.8 \times 0.7 \times 0.17 \times 1 = 0.0952\%/1000 \text{ Hours}$

If the capacitor was changed for a 20 volt capacitor, the operating failure rate will change as shown.

$F_U = 0.05 @ \text{applied voltage/rated voltage} = 60\%$

$F_B = 0.8 \times 0.7 \times 0.05 \times 1 = 0.028\%/1000 \text{ Hours}$

## 3.2 DYNAMIC

As stated in Section 1.2.4 (page 123), the solid Tantalum capacitor has a limited ability to withstand voltage and current surges. Such current surges can cause a capacitor to fail. The expected failure rate cannot be calculated by a simple formula as in the case of steady-state reliability. The two parameters under the control of the circuit design engineer known to reduce the incidence of failures are derating and series resistance. The table below summarizes the results of trials carried out at AVX with a piece of equipment which has very low series resistance and applied no derating. So that the capacitor was tested at its rated voltage.

**Results of production scale derating experiment**

Capacitance and Voltage	Number of units tested	50% derating applied	No derating applied
47μF 16V	1,547,587	0.03%	1.1%
100μF 10V	632,876	0.01%	0.5%
22μF 25V	2,256,258	0.05%	0.3%

As can clearly be seen from the results of this experiment, the more derating applied by the user, the less likely the probability of a surge failure occurring.

It must be remembered that these results were derived from a highly accelerated surge test machine, and failure rates in the low ppm are more likely with the end customer.



# TAP Technical Summary and Application Guidelines



A commonly held misconception is that the leakage current of a Tantalum capacitor can predict the number of failures which will be seen on a surge screen. This can be disproved by the results of an experiment carried out at AVX on 47µF 10V surface mount capacitors with different leakage currents. The results are summarized in the table below.

### Leakage Current vs Number of Surge Failures

	Number tested	Number failed surge
Standard leakage range 0.1 µA to 1µA	10,000	25
Over Catalog limit 5µA to 50µA	10,000	26
Classified Short Circuit 50µA to 500µA	10,000	25

Again, it must be remembered that these results were derived from a highly accelerated surge test machine, and failure rates in the low ppm are more likely with the end customer.

### AVX recommended derating table

Voltage Rail	Working Cap Voltage
3.3	6.3
5	10
10	20
12	25
15	35
≥24	Series Combinations (11)

For further details on surge in Tantalum capacitors refer to J.A. Gill's paper "Surge in Solid Tantalum Capacitors", available from AVX offices worldwide.

An added bonus of increasing the derating applied in a circuit, to improve the ability of the capacitor to withstand surge conditions, is that the steady-state reliability is improved by up to an order. Consider the example of a 6.3 volt capacitor being used on a 5 volt rail. The steady-state reliability of a Tantalum capacitor is affected by three parameters; temperature, series resistance and voltage derating. Assuming 40°C operation and 0.1Ω/volt of series resistance, the scaling factors for temperature and series resistance will both be 0.05 [see Section 3.1 (page 127)]. The derating factor will be 0.15. The capacitors reliability will therefore be

$$\begin{aligned} \text{Failure rate} &= F_U \times F_T \times F_R \times 1\%/1000 \text{ hours} \\ &= 0.15 \times 0.05 \times 1 \times 1\%/1000 \text{ hours} \\ &= 7.5\% \times 10^{-3}/\text{hours} \end{aligned}$$

If a 10 volt capacitor was used instead, the new scaling factor would be 0.017, thus the steady-state reliability would be

$$\begin{aligned} \text{Failure rate} &= F_U \times F_T \times F_R \times 1\%/1000 \text{ hours} \\ &= 0.017 \times 0.05 \times 1 \times 1\%/1000 \text{ hours} \\ &= 8.5\% \times 10^{-4}/1000 \text{ hours} \end{aligned}$$

So there is an order improvement in the capacitors steady-state reliability.

## 3.3 RELIABILITY TESTING

AVX performs extensive life testing on tantalum capacitors.

- 2,000 hour tests as part of our regular Quality Assurance Program.

### Test conditions:

- 85°C/rated voltage/circuit impedance of 3Ω max.
- 125°C/0.67 x rated voltage/circuit impedance of 3Ω max.

### 3.4 Mode of Failure

This is normally an increase in leakage current which ultimately becomes a short circuit.

# TAP Technical Summary and Application Guidelines



## SECTION 4: APPLICATION GUIDELINES FOR TANTALUM CAPACITORS

### 4.1 SOLDERING CONDITIONS AND BOARD ATTACHMENT

The soldering temperature and time should be the minimum for a good connection.

A suitable combination for wavesoldering is 230°C - 250°C for 3 - 5 seconds.

Small parametric shifts may be noted immediately after wave solder, components should be allowed to stabilize at room temperature prior to electrical testing.

AVX leaded tantalum capacitors are designed for wave soldering operations.

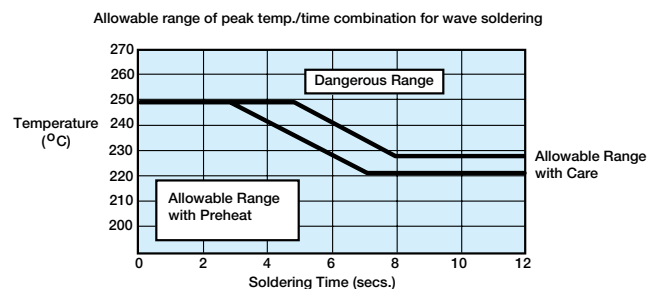

### 4.2 RECOMMENDED SOLDERING PROFILES

Recommended wave soldering profile for mounting of tantalum capacitors is shown below.

After soldering the assembly should preferably be allowed to cool naturally. In the event that assisted cooling is used, the rate of change in temperature should not exceed that used in reflow.

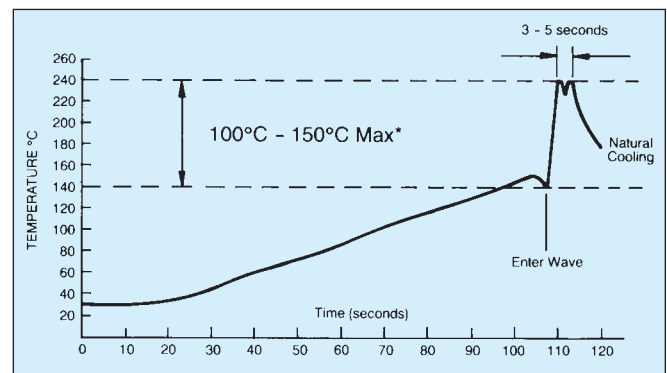

\*See appropriate product specification

## SECTION 5: MECHANICAL AND THERMAL PROPERTIES, LEADED CAPACITORS

### 5.1 ACCELERATION

10 g (981 m/s)

### 5.2 VIBRATION SEVERITY

10 to 2000 Hz, 0.75 mm or 98 m/s<sup>2</sup>

### 5.3 SHOCK

Trapezoidal Pulse 10 g (981 m/s) for 6 ms

### 5.4 TENSILE STRENGTH OF CONNECTION

10 N for type TAR, 5 N for type TAP.

### 5.5 BENDING STRENGTH OF CONNECTIONS

2 bends at 90°C with 50% of the tensile strength test loading.

### 5.6 SOLDERING CONDITIONS

Dip soldering permissible provided solder bath temperature  $\leq 270^\circ\text{C}$ ; solder time  $< 3$  sec.; circuit board thickness  $\leq 1.0$  mm.

### 5.7 INSTALLATION INSTRUCTIONS

The upper temperature limit (maximum capacitor surface temperature) must not be exceeded even under the most unfavorable conditions when the capacitor is installed. This must be considered particularly when it is positioned near components which radiate heat strongly (e.g., valves and power transistors). Furthermore, care must be taken, when bending the wires, that the bending forces do not strain the capacitor housing.

### 5.8 INSTALLATION POSITION

No restriction.

### 5.9 SOLDERING INSTRUCTIONS

Fluxes containing acids must not be used.

# Technical Summary and Application Guidelines

## QUESTIONS AND ANSWERS

Some commonly asked questions regarding Tantalum Capacitors:

**Question:** If I use several tantalum capacitors in serial/parallel combinations, how can I ensure equal current and voltage sharing?

**Answer:** Connecting two or more capacitors in series and parallel combinations allows almost any value and rating to be constructed for use in an application. For example, a capacitance of more than 60µF is required in a circuit for stable operation. The working voltage rail is 24 Volts dc with a superimposed ripple of 1.5 Volts at 120 Hz.

The maximum voltage seen by the capacitor is  $V_{dc} + V_{ac} = 25.5V$

Applying the 50% derate rule tells us that a 50V capacitor is required.

Connecting two 25V rated capacitors in series will give the required capacitance voltage rating, but the effective capacitance will be halved, so for greater than

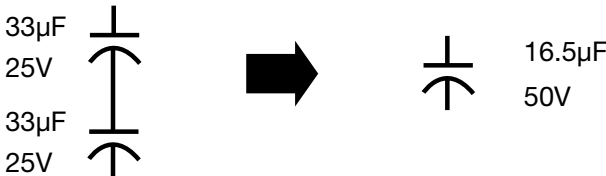

60µF, four such series combinations are required, as shown.

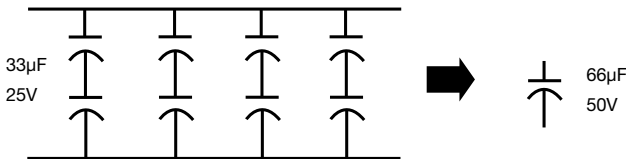

In order to ensure reliable operation, the capacitors should be connected as shown below to allow current sharing of the ac noise and ripple signals. This prevents any one capacitor heating more than its neighbors and thus being the weak link in the chain.

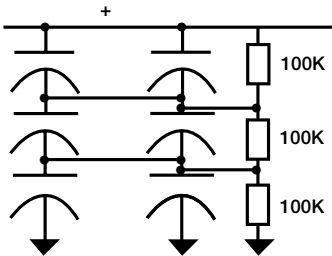

The two resistors are used to ensure that the leakage currents of the capacitors does not affect the circuit reliability, by ensuring that all the capacitors have half the working voltage across them.

**Question:** What are the advantages of tantalum over other capacitor technologies?

**Answer:**

1. Tantalums have high volumetric efficiency.
2. Electrical performance over temperature is very stable.
3. They have a wide operating temperature range -55 degrees C to +125 degrees C.
4. They have better frequency characteristics than aluminum electrolytics.
5. No wear out mechanism. Because of their construction, solid tantalum capacitors do not degrade in performance or reliability over time.

**Question:** If the part is rated as a 25 volt part and you have current surged it, why can't I use it at 25 volts in a low impedance circuit?

**Answer:** The high volumetric efficiency obtained using tantalum technology is accomplished by using an extremely thin film of tantalum pentoxide as the dielectric. Even an application of the relatively low voltage of 25 volts will produce a large field strength as seen by the dielectric. As a result of this, derating has a significant impact on reliability as described under the reliability section. The following example uses a 22 microfarad capacitor rated at 25 volts to illustrate the point. The equation for determining the amount of surface area for a capacitor is as follows:

$$C = ( \epsilon_r \epsilon_0 (A) ) / d$$

$$A = ( C (d) ) / ( \epsilon_r \epsilon_0 )$$

$$A = ( (22 \times 10^{-6}) (170 \times 10^{-9}) ) / ( (8.85 \times 10^{-12}) (27) )$$

$$A = 0.015 \text{ square meters (150 square centimeters)}$$

Where C = Capacitance in farads

A = Dielectric (Electrode) Surface Area (m<sup>2</sup>)

d = Dielectric thickness (Space between dielectric) (m)

$\epsilon_r$  = Dielectric constant (27 for tantalum)

$\epsilon_0$  = Dielectric Constant relative to a vacuum  
( $8.855 \times 10^{-12}$  Farads x m<sup>-1</sup>)

To compute the field voltage potential felt by the dielectric we use the following logic.

$$\text{Dielectric formation potential} = \text{Formation Ratio} \times \text{Working Voltage}$$

$$= 4 \times 25$$

$$\text{Formation Potential} = 100 \text{ volts}$$

$$\text{Dielectric (Ta}_2\text{O}_5\text{) Thickness (d) is } 1.7 \times 10^{-9} \text{ Meters Per Volt}$$

$$d = 0.17 \mu \text{ meters}$$

$$\text{Electric Field Strength} = \text{Working Voltage} / d$$

$$= (25 / 0.17 \mu \text{ meters})$$

$$= 147 \text{ Kilovolts per millimeter}$$

$$= 147 \text{ Megavolts per meter}$$

# Technical Summary and Application Guidelines



## QUESTIONS AND ANSWERS

No matter how pure the raw tantalum powder or the precision of processing, there will always be impurity sites in the dielectric. We attempt to stress these sites in the factory with overvoltage surges, and elevated temperature burn in so that components will fail in the factory and not in your product. Unfortunately, within this large area of tantalum pentoxide, impurity sites will exist in all capacitors. To minimize the possibility of providing enough activation energy for these impurity sites to turn from an amorphous state to a crystalline state that will conduct energy, series resistance and derating is recommended. By reducing the electric field within the anode at these sites, the tantalum capacitor has increased reliability. Tantalums differ from other electrolytics in that charge transients are carried by electronic conduction rather than absorption of ions.

**Question:** What negative transients can Solid Tantalum Capacitors operate under?

**Answer:** The reverse voltage ratings are designed to cover exceptional conditions of small level excursions into incorrect polarity. The values quoted are not intended to cover continuous reverse operation. The peak reverse voltage applied to the capacitor must not exceed:

10% of rated DC working voltage to a maximum of 1 volt at 25°C.

3% of rated DC working voltage to a maximum of 0.5 volt at 85°C.

1% of category DC working voltage to a maximum of 0.1 volt at 125°C.

**Question:** I have read that manufacturers recommend a series resistance of 0.1 ohm per working volt. You suggest we use 1 ohm per volt in a low impedance circuit. Why?

**Answer:** We are talking about two very different sets of circuit conditions for those recommendations. The 0.1 ohm per volt recommendation is for steady-state conditions. This level of resistance is used as a basis for the series resistance variable in a 1% / 1000 hours 60% confidence level reference. This is what steady-state life tests are based on. The 1 ohm per volt is recommended for dynamic conditions which include current in-rush applications such as inputs to power supply circuits. In many power supply topologies where the  $di/dt$  through the capacitor(s) is limited, (such as most implementations of buck (current mode), forward converter, and flyback), the requirement for series resistance is decreased.

**Question:** How long is the shelf life for a tantalum capacitor?

**Answer:** Solid tantalum capacitors have no limitation on shelf life. The dielectric is stable and no reformation is required. The only factors that affect future performance of the capacitors would be high humidity conditions and extreme storage temperatures. Solderability of solder coated surfaces may be affected by storage in excess of 2 years. Recommended storage conditions are: Temperature between 15°C and 35°C with humidity 45%-75% RH. Terminations should be checked for solderability in the event an oxidation develops on the solder plating.

**Question:** What level of voltage derating is needed for Tantalum Capacitors?

**Answer:** For many years whenever people have asked a tantalum capacitor manufacturer about what were the safe guidelines for using their product, they spoke with one voice “a minimum of 50% voltage derating should be applied”. This message has since become ingrained and automatic. This article challenges this statement and explains why it is not necessarily the case.

The 50% rule came about when tantalum capacitors started to be used on low impedance sources. In such applications, the available current is high and therefore a risk of failure is inherent. Well established by empirical methods and covered in MIL-STD 317, was the fact that the amount of voltage derating has a major influence on the failure rate of a tantalum capacitor (Figure 1). Indeed, from rated voltage to 50% of rated voltage is an improvement in failure rate of more than 100.

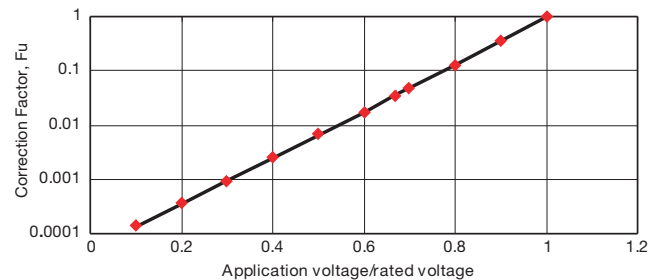
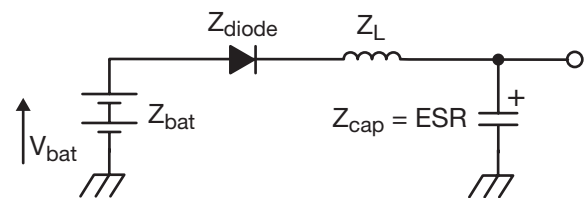

Figure 1

It was also proved that the same was true of dynamic, high current pulse conditions<sup>1</sup>, hence the recommendation.

Now let us look more closely at the type of circuits in use. Below is a simple circuit which will be discussed further in this text.



Let us assume this is a 2 cell battery system, therefore  $V_{bat} = 3.2$  Volts

Also, let us assume

$Z_{bat} = 60$  m $\Omega$ ,  $Z_{diode} = 70$  m $\Omega$ ,  $Z_{cap} = 120$  m $\Omega$ ,  $Z_L = 70$  m $\Omega$

If the “50% rule” was followed, the designer should chose a 6.3V rated capacitor.

<sup>1</sup> Surge in solid tantalum capacitors, John Gill, AVX Tantalum

# Technical Summary and Application Guidelines



The total circuit impedance of the system is 320 mΩ. So by Ohm's law the peak current would be 10 Amps.

This exceeds the test conditions used by AVX to screen its product for high current pulses<sup>1</sup>, so a risk of failure exists. Clearly a minimum of a 10 volt rate capacitor is required in this application.

As a general rule of thumb, the maximum current a tantalum capacitor can withstand (provided it has not been damaged by thermomechanical damage<sup>2 3</sup> or some other external influence) is given by the equation:

$$I_{max} = V_{rated} / (1 + \text{Catalog ESR})$$

So for example for a 100μF 10V D case capacitor (Catalog ESR = 0.9 Ohms), this would be:

$$I_{max} = 10 / (1 + 0.9) = 5.2 \text{ Amps}$$

In some circuits, because of size restrictions, a tantalum capacitor may be the only option available. If this is the case, AVX recommends a PFET integrator be used to slow the voltage ramp at turn on, which in effect reduces the peak current, and therefore reduces the risk of failure<sup>4</sup>.

Now, let's consider a continuation of the circuit with the addition of an LDO or DC/DC convertor.

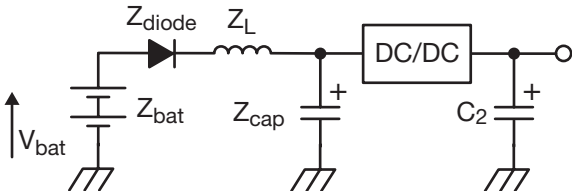

The risk of a high surge current being seen by the capacitor in location C<sub>2</sub> is very small. Therefore if we assume the voltage rail is 2.8 volts and the maximum current seen by C<sub>2</sub> is <1.5 Amps, a 4 volt capacitor could be able to be used in this application.

This all seems like good news, but as always, there are some downsides to using a part nearer to its rated voltage. The first is the steady-state life, or MTBF. The MTBF of a tantalum capacitor is easily calculated from MIL-STD 317 or the supplier's catalog data. An example is given below:

Assume operating temperature is 85°C and circuit impedance 0.1 Ohms/volt (F<sub>T</sub> = 1).

For a 10 volt rated capacitor on a 5 volt rated line, the failure rate is:

$$\begin{aligned} F_R &= 1\%/1000 \text{ hours} \times F_T \times F_U \times F_R \\ &= 1\%/1000 \text{ hours} \times 1 \times 0.007 \text{ (from Figure 1)} \times 1 \\ &= 0.007\%/1000 \text{ hours} \end{aligned}$$

$$\begin{aligned} \text{MTBF} &= 10^5 / F_R \\ &= 14,285,238 \text{ hours} \\ &= 1,631 \text{ years} \end{aligned}$$

For a 6.3 volt rated capacitor on a 5 volt rated line, the failure rate is:

$$\begin{aligned} F_R &= 1\%/1000 \text{ hours} \times F_T \times F_U \times F_R \\ &= 1\%/1000 \text{ hours} \times 1 \times 0.12 \text{ (from Figure 1)} \times 1 \\ &= 0.12\%/1000 \text{ hours} \end{aligned}$$

$$\begin{aligned} \text{MTBF} &= 10^5 / F_R \\ &= 833,333 \text{ hours} \\ &= 95 \text{ years} \end{aligned}$$

The second factor to be considered is that the more derating applied to a tantalum capacitor, the lower the leakage current level (Figure 2). Therefore a part used at 50% of its rated voltage will have more than 3 times better leakage levels than one used at 80%.

**Leakage Current vs. Rated Voltage**

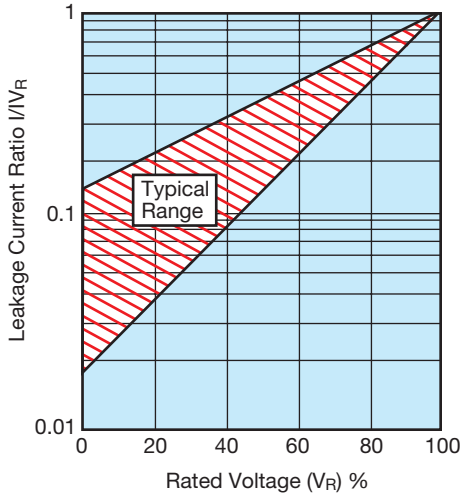

Figure 2

One final point worthy of mention with the introduction of higher reflow temperatures with the introduction of lead-free solders is that voltage derating can help to reduce the risk of failures due to thermomechanical damage during reflow.

To summarize, a tantalum capacitor is capable of being used at its rated voltage or close to it, provided that the user obeys the rules outlined in this document and is prepared for the reduced steady-state life performance and higher leakage current levels this would produce.

<sup>1</sup> Surge in Solid Tantalum Capacitors, John Gill, AVX Tantalum  
<sup>2</sup> IR Reflow Guidelines for Tantalum Capacitors, Steve Warden & John Gill, AVX Tantalum  
<sup>3</sup> Mounting Guidelines in AVX Tantalum Catalog  
<sup>4</sup> Improving Reliability of Tantalum Capacitors in Low Impedance Circuits, Dave Mattingly, AVX



## PASSIVES

### Capacitors

Multilayer Ceramic  
Film  
Glass  
Niobium Oxide\* - OxiCap™  
Pulse Supercapacitors  
Tantalum

### Circuit Protection

Thermistors  
Fuses - Thin Film  
Transient Voltage Suppressors  
Varistors - Zinc Oxide

### Directional Couplers

Thin-Film

### Filters

Ceramic  
EMI  
Noise  
SAW  
Low Pass - Thin Film

### Inductors

Thin-Film

### Integrated Passive Components

PMC - Thin-Film Networks  
Capacitor Arrays  
Feedthru Arrays  
Low Inductance Decoupling Arrays

### Piezo Acoustic Generators

Ceramic

### Resistors

Arrays  
Miniature Axials

### Timing Devices

Clock Oscillators  
MHz Quartz Crystal  
Resonators  
VCO  
TCXO

## CONNECTORS

### Automotive

Standard, Custom

### Board to Board

SMD (0.4, 0.5, 1.0mm), BGA, Thru-Hole

### Card Edge

### DIN41612

Standard, Inverse, High Temperature

### FFC/FPC

0.3, 0.5, 1.0mm

### Hand Held, Cellular

Battery, I/O, SIMcard, RF shield clips

### 2mm Hard Metric

Standard, Reduced Cross-Talk

### IDC Wire to Board

Headers, Plugs, Assemblies

### Memory

PCMCIA, Compact Flash, Secure Digital, MMC,  
Smartcard, SODIMM

### Military

H Government, DIN41612

### Polytect™

Soft Molding

### Rack and Panel

Varicon™

**For more information please visit  
our website at**

**<http://www.avx.com>**

NOTICE: Specifications are subject to change without notice. Contact your nearest AVX Sales Office for the latest specifications. All statements, information and data given herein are believed to be accurate and reliable, but are presented without guarantee, warranty, or responsibility of any kind, expressed or implied. Statements or suggestions concerning possible use of our products are made without representation or warranty that any such use is free of patent infringement and are not recommendations to infringe any patent. The user should not assume that all safety measures are indicated or that other measures may not be required. Specifications are typical and may not apply to all applications.

© AVX Corporation

"Niobium Oxide Capacitors are manufactured and sold under patent license from Cabot Corporation, Boyertown, Pennsylvania U.S.A."

## USA

**AVX Myrtle Beach, SC**  
Corporate Offices  
Tel: 843-448-9411  
FAX: 843-448-1943

**AVX North Central, IN**  
Tel: 317-848-7153  
FAX: 317-844-9314

**AVX Southwest, AZ**  
Tel: 602-678-0384  
FAX: 602-678-0385

**AVX Southeast, GA**  
Tel: 404-608-8151  
FAX: 770-972-0766

**AVX Northwest, WA**  
Tel: 360-699-8746  
FAX: 360-699-8751

**AVX Mid/Pacific, CA**  
Tel: 510-661-4100  
FAX: 510-661-4101

**AVX South Central, TX**  
Tel: 972-669-1223  
FAX: 972-669-2090

**AVX Canada**  
Tel: 905-238-3151  
FAX: 905-238-0319

## EUROPE

**AVX Limited, England**  
European Headquarters  
Tel: ++44 (0) 1252-770000  
FAX: ++44 (0) 1252-770001

**AVX/ELCO, England**  
Tel: ++44 (0) 1638-675000  
FAX: ++44 (0) 1638-675002

**AVX S.A., France**  
Tel: ++33 (1) 69-18-46-00  
FAX: ++33 (1) 69-28-73-87

**AVX GmbH, Germany**  
Tel: ++49 (0) 8131-9004-0  
FAX: ++49 (0) 8131-9004-44

**AVX srl, Italy**  
Tel: ++390 (0)2 614-571  
FAX: ++390 (0)2 614-2576

**AVX Czech Republic**  
Tel: ++420 465-358-111  
FAX: ++420 465-323-010

## ASIA-PACIFIC

**AVX/Kyocera, Singapore**  
Asia-Pacific Headquarters  
Tel: (65) 6286-7555  
FAX: (65) 6488-9880

**AVX/Kyocera, Hong Kong**  
Tel: (852) 2-363-3303  
FAX: (852) 2-765-8185

**AVX/Kyocera, Korea**  
Tel: (82) 2-785-6504  
FAX: (82) 2-784-5411

**AVX/Kyocera, Taiwan**  
Tel: (886) 2-2698-8778  
FAX: (886) 2-2698-8777

**AVX/Kyocera, Malaysia**  
Tel: (60) 4-228-1190  
FAX: (60) 4-228-1196

**Elco, Japan**  
Tel: 045-943-2906/7  
FAX: 045-943-2910

**Kyocera, Japan - AVX**  
Tel: (81) 75-604-3426  
FAX: (81) 75-604-3425

**Kyocera, Japan - KDP**  
Tel: (81) 75-604-3424  
FAX: (81) 75-604-3425

**AVX/Kyocera, Shanghai, China**  
Tel: 86-21 6341 0300  
FAX: 86-21 6341 0330

**AVX/Kyocera, Tianjin, China**  
Tel: 86-22 2576 0098  
FAX: 86-22 2576 0096

**Contact:**

