

**AVX**

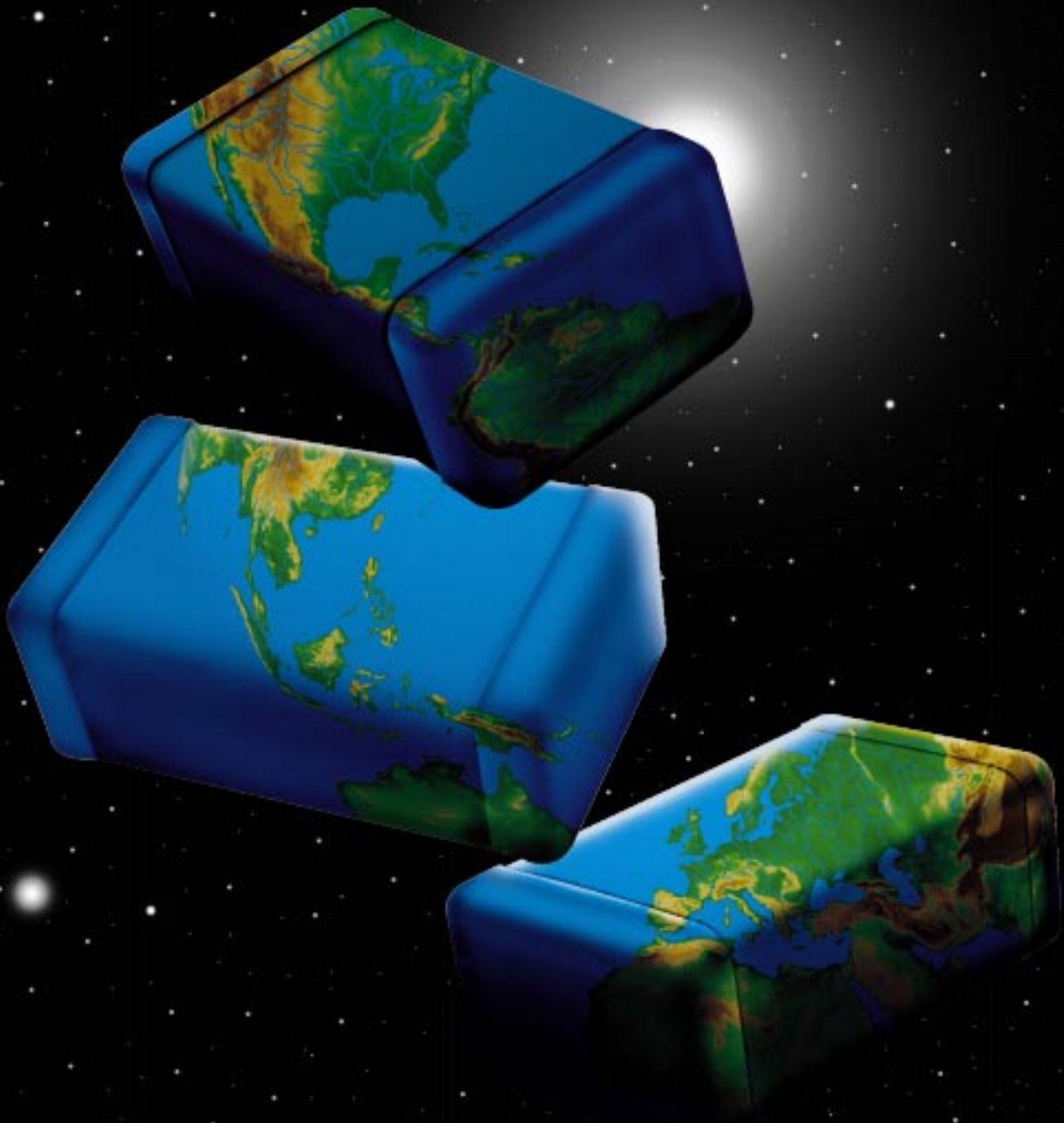

**AVX**  
**Multilayer Ceramic**  
**Chip Capacitor**

## Table of Contents

---

- Basic Capacitor Formulas** . . . . . 2
- How to Order - AVX Part Number Explanation** . . . . . 3
- C0G (NP0) Dielectric**
  - General Specifications . . . . . 4
  - Typical Characteristic Curves. . . . . 5
  - Capacitance Range . . . . . 6 - 7
- X7R Dielectric**
  - General Specifications . . . . . 8
  - Typical Characteristic Curves. . . . . 9
  - Capacitance Range . . . . . 10 - 11
- Z5U Dielectric**
  - General Specifications . . . . . 12
  - Typical Characteristic Curves . . . . . 13
  - Capacitance Range . . . . . 14 - 15
- Y5V Dielectric**
  - General Specifications . . . . . 16
  - Typical Characteristic Curves . . . . . 17
  - Capacitance Range . . . . . 18
- Low Profile Chips for Z5U & Y5V Dielectric** . . . . . 19
- High Voltage Chips for 500V to 5000V Applications** . . . . . 20 - 21
- General Specifications**
  - Environmental . . . . . 22 - 23
  - Mechanical . . . . . 24
- MIL-PRF-55681/Chips**
  - Part Number Example . . . . . 25
  - Military Part Number Identification (CDR01 thru CDR06) . . . . . 26
  - Military Part Number Identification (CDR31 thru CDR35) . . . . . 27
  - Military Part Number Identification (CDR31) . . . . . 28
  - Military Part Number Identification (CDR32) . . . . . 29
  - Military Part Number Identification (CDR33/34/35) . . . . . 30
- European Version CECC 32 101-801 Chips** . . . . . 31
- Packaging of Chip Components Automatic Insertion Packaging** . . . . . 32
- Embossed Carrier Configuration - 8 & 12mm Tape** . . . . . 33
- Paper Carrier Configuration - 8 & 12mm Tape** . . . . . 34
- Bulk Case Packaging** . . . . . 35
- MLC Chip Capacitors General Description** . . . . . 36 - 40
- Surface Mounting Guide** . . . . . 41 - 43

## I. Capacitance (farads)

English:  $C = \frac{.224 \text{ K A}}{T_D}$

Metric:  $C = \frac{.0884 \text{ K A}}{T_D}$

## II. Energy stored in capacitors (Joules, watt - sec)

$E = \frac{1}{2} CV^2$

## III. Linear charge of a capacitor (Amperes)

$I = C \frac{dV}{dt}$

## IV. Total Impedance of a capacitor (ohms)

$Z = \sqrt{R_s^2 + (X_C - X_L)^2}$

## V. Capacitive Reactance (ohms)

$X_C = \frac{1}{2 \pi fC}$

## VI. Inductive Reactance (ohms)

$X_L = 2 \pi fL$

## VII. Phase Angles:

Ideal Capacitors: Current leads voltage 90°

Ideal Inductors: Current lags voltage 90°

Ideal Resistors: Current in phase with voltage

## VIII. Dissipation Factor (%)

$D.F. = \tan \delta \text{ (loss angle)} = \frac{E.S.R.}{X_C} = (2 \pi fC) (E.S.R.)$

## IX. Power Factor (%)

P.F. = Sine  $\delta$  (loss angle) = Cos  $\phi$  (phase angle)

P.F. = (when less than 10%) = DF

## X. Quality Factor (dimensionless)

$Q = \text{Cotan } \delta \text{ (loss angle)} = \frac{1}{D.F.}$

## XI. Equivalent Series Resistance (ohms)

$E.S.R. = (D.F.) (X_C) = (D.F.) / (2 \pi fC)$

## XII. Power Loss (watts)

Power Loss =  $(2 \pi fCV^2) (D.F.)$

## XIII. KVA (Kilowatts)

$KVA = 2 \pi fCV^2 \times 10^{-3}$

## XIV. Temperature Characteristic (ppm/°C)

$T.C. = \frac{C_t - C_{25}}{C_{25} (T_t - 25)} \times 10^6$

## XV. Cap Drift (%)

$C.D. = \frac{C_1 - C_2}{C_1} \times 100$

## XVI. Reliability of Ceramic Capacitors

$\frac{L_o}{L_t} = \left( \frac{V_t}{V_o} \right)^X \left( \frac{T_t}{T_o} \right)^Y$

## XVII. Capacitors in Series (current the same)

Any Number:  $\frac{1}{C_T} = \frac{1}{C_1} + \frac{1}{C_2} \dots \frac{1}{C_N}$

Two:  $C_T = \frac{C_1 C_2}{C_1 + C_2}$

## XVIII. Capacitors in Parallel (voltage the same)

$C_T = C_1 + C_2 \dots + C_N$

## XIX. Aging Rate

A.R. = % $\Delta$  C/decade of time

## XX. Decibels

$db = 20 \log \frac{V_1}{V_2}$

## METRIC PREFIXES

## SYMBOLS

Pico	$\times 10^{-12}$	K	= Dielectric Constant	f	= frequency	$L_t$	= Test life
Nano	$\times 10^{-9}$	A	= Area	L	= Inductance	$V_t$	= Test voltage
Micro	$\times 10^{-6}$	$T_D$	= Dielectric thickness	$\delta$	= Loss angle	$V_o$	= Operating voltage
Milli	$\times 10^{-3}$	V	= Voltage	$\phi$	= Phase angle	$T_t$	= Test temperature
Deci	$\times 10^{-1}$	t	= time	X & Y	= exponent effect of voltage and temp.	$T_o$	= Operating temperature
Deca	$\times 10^{+1}$	$R_s$	= Series Resistance	$L_o$	= Operating life		
Deca	$\times 10^{+1}$						
Kilo	$\times 10^{+3}$						
Mega	$\times 10^{+6}$						
Giga	$\times 10^{+9}$						
Tera	$\times 10^{+12}$						

# How to Order

## Part Number Explanation



### EXAMPLE: 08055A101JAT2A

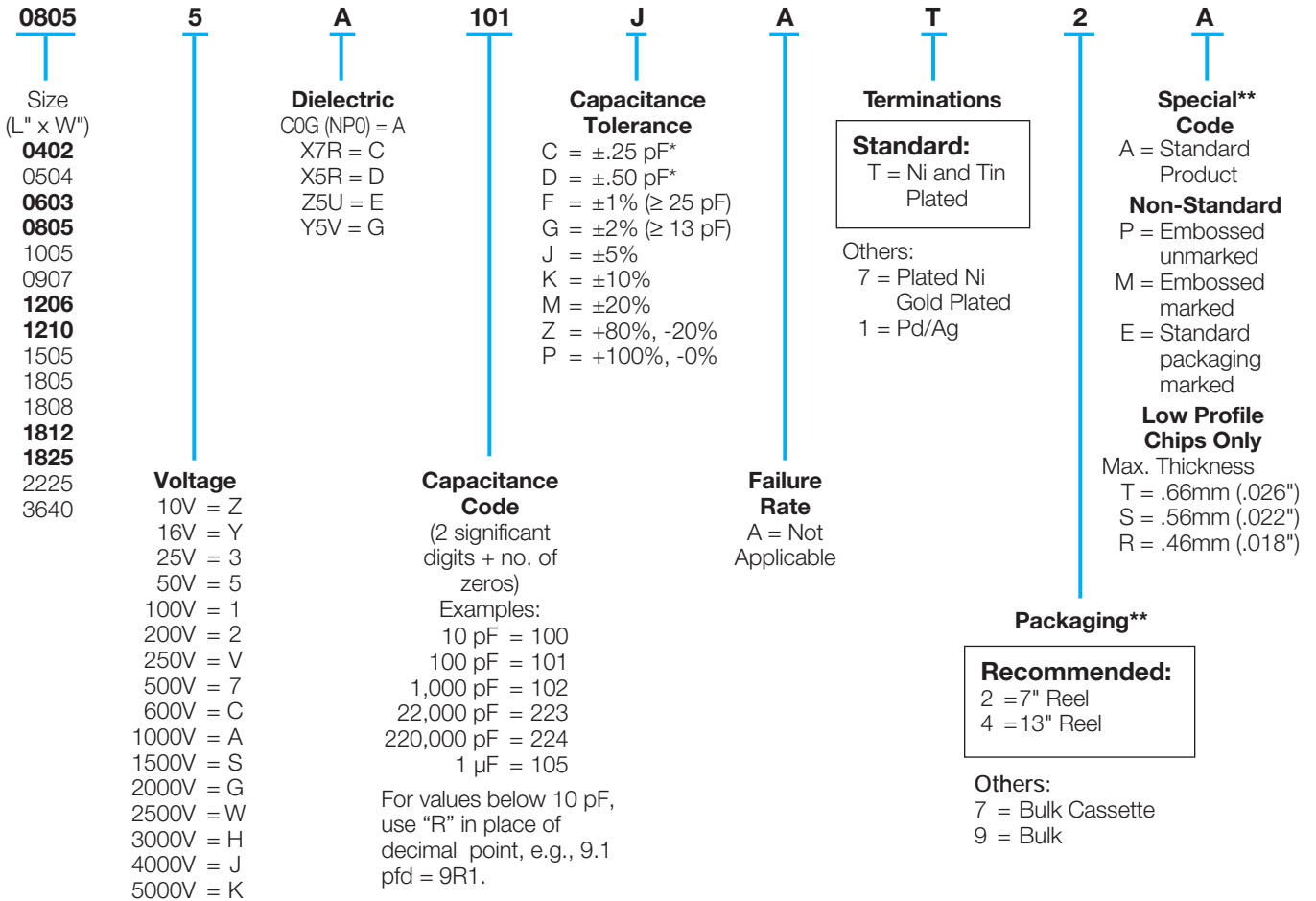

\* C&D tolerances for  $\leq 10$  pF values.

\*\* Standard Tape and Reel material depends upon chip size and thickness. See individual part tables for tape material type for each capacitance value.

Note: Unmarked product is standard. Marked product is available on special request, please contact AVX. Standard packaging is shown in the individual tables.

Non-standard packaging is available on special request, please contact AVX.

# C0G (NP0) Dielectric



## General Specifications

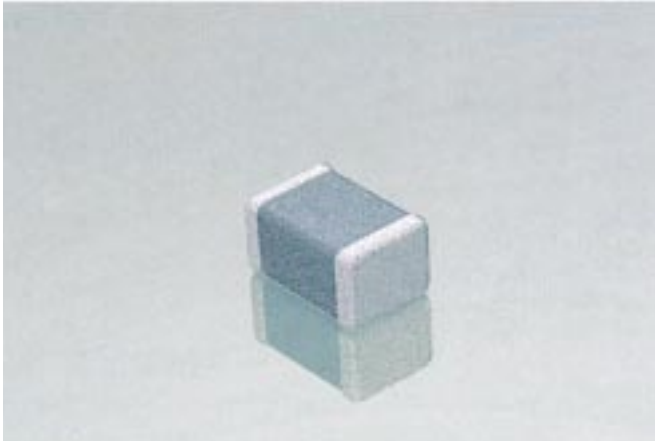

C0G (NP0) is the most popular formulation of the “temperature-compensating,” EIA Class I ceramic materials. Modern C0G (NP0) formulations contain neodymium, samarium and other rare earth oxides.

C0G (NP0) ceramics offer one of the most stable capacitor dielectrics available. Capacitance change with temperature is  $0 \pm 30 \text{ ppm}/^\circ\text{C}$  which is less than  $\pm 0.3\% \Delta C$  from  $-55^\circ\text{C}$  to  $+125^\circ\text{C}$ . Capacitance drift or hysteresis for C0G (NP0) ceramics is negligible at less than  $\pm 0.05\%$  versus up to  $\pm 2\%$  for films. Typical capacitance change with life is less than  $\pm 0.1\%$  for C0G (NP0), one-fifth that shown by most other dielectrics. C0G (NP0) formulations show no aging characteristics.

The C0G (NP0) formulation usually has a “Q” in excess of 1000 and shows little capacitance or “Q” changes with frequency. Their dielectric absorption is typically less than 0.6% which is similar to mica and most films.

## PART NUMBER (see page 3 for complete part number explanation)

**0805**

**Size**  
(L" x W")

**5**

**Voltage**  
25V = 3  
50V = 5  
100V = 1  
200V = 2

**A**

**Dielectric**  
C0G (NP0) = A

**101**

**Capacitance Code**

**J**

**Capacitance Tolerance**  
Preferred  
K =  $\pm 10\%$   
J =  $\pm 5\%$

**A**

**Failure Rate**  
A = Not Applicable

**T**

**Terminations**  
T = Plated Ni and Solder

**2**

**Packaging**  
2 = 7" Reel  
4 = 13" Reel

**A**

**Special Code**  
A = Std. Product

## PERFORMANCE CHARACTERISTICS

<b>Capacitance Range</b>	0.5 pF to .1 $\mu\text{F}$ (1.0 $\pm 0.2$ Vrms, 1kHz, for $\leq 100$ pF use 1 MHz)
<b>Capacitance Tolerances</b>	Preferred $\pm 5\%$ , $\pm 10\%$ others available: $\pm .25$ pF, $\pm .5$ pF, $\pm 1\%$ ( $\geq 25$ pF), $\pm 2\%$ ( $\geq 13$ pF), $\pm 20\%$ For values $\leq 10$ pF preferred tolerance is $\pm .5$ pF, also available $\pm .25$ pF.
<b>Operating Temperature Range</b>	$-55^\circ\text{C}$ to $+125^\circ\text{C}$
<b>Temperature Characteristic</b>	$0 \pm 30$ ppm/ $^\circ\text{C}$ (EIA C0G)
<b>Voltage Ratings</b>	25, 50, 100 & 200 VDC ( $+125^\circ\text{C}$ )
<b>Dissipation Factor and “Q”</b>	For values $> 30$ pF: 0.1% max. ( $+25^\circ\text{C}$ and $+125^\circ\text{C}$ ) For values $\leq 30$ pF: “Q” = $400 + 20 \times C$ (C in pF)
<b>Insulation Resistance (+25<math>^\circ\text{C}</math>, RVDC)</b>	100,000 megohms min. or 1000 $\text{M}\Omega$ - $\mu\text{F}$ min., whichever is less
<b>Insulation Resistance (+125<math>^\circ\text{C}</math>, RVDC)</b>	10,000 megohms min. or 100 $\text{M}\Omega$ - $\mu\text{F}$ min., whichever is less
<b>Dielectric Strength</b>	250% of rated voltage for 5 seconds at 50 mamp max. current
<b>Test Voltage</b>	$1 \pm 0.2$ Vrms
<b>Test Frequency</b>	For values $\leq 100$ pF: 1 MHz For values $> 100$ pF: 1 KHz

# C0G (NP0) Dielectric



## Typical Characteristic Curves\*\*

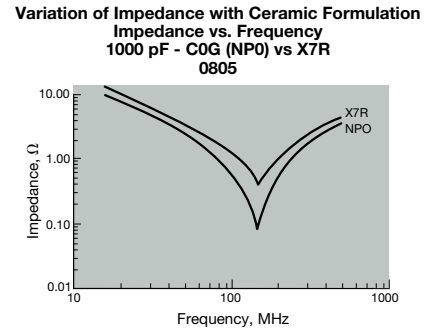
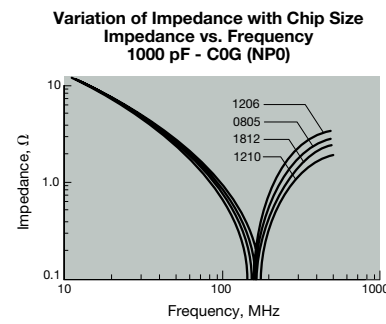
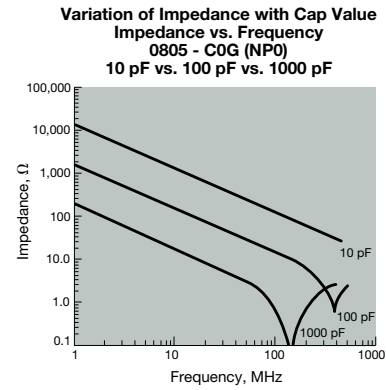
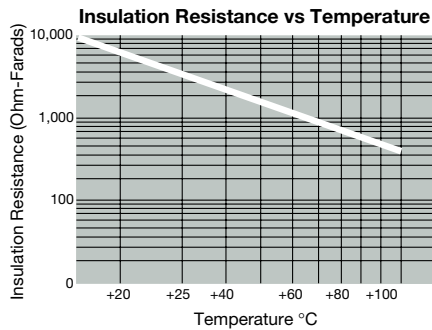
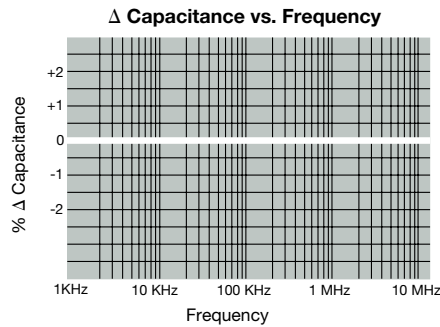
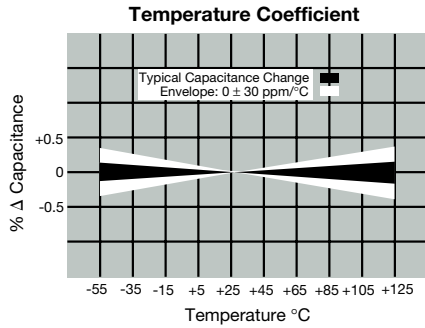

### SUMMARY OF CAPACITANCE RANGES VS. CHIP SIZE

Style	25V	50V	100V	200V
0402*	0.5pF - 220pF	0.5pF - 120pF	—	—
0504	0.5pF - 330pF	0.5pF - 150pF	0.5pF - 68pF	—
0603*	0.5pF - 1nF	0.5pF - 1nF	0.5pF - 330pF	—
0805*	0.5pF - 4.7nF	0.5pF - 2.2nF	0.5pF - 1nF	0.5pF - 470pF
1206*	0.5pF - 10nF	0.5pF - 4.7nF	0.5pF - 2.2nF	0.5pF - 1nF
1210*	560pF - 10nF	560pF - 10nF	560pF - 3.9nF	560pF - 1.5nF
1505	—	10pF - 1.5nF	10pF - 820pF	10pF - 560pF
1808	→	1nF - 4.7nF	1nF - 3.9nF	1nF - 2.2nF
1812*	1nF - 15nF	1nF - 10nF	1nF - 4.7nF	1nF - 3.3nF
1825*	→	1nF - 22nF	1nF - 12nF	1nF - 6.8nF
2220	→	4.7nF - 47nF	4.7nF - 39nF	3.3nF - 27nF
2225	→	1nF - 100nF	1nF - 39nF	1nF - 39nF

\* Standard Sizes

\*\* For additional information on performance changes with operating conditions consult AVX's software SpiCap.

# COG (NP0) Dielectric



## Capacitance Range

PREFERRED SIZES ARE SHADED

SIZE		0402*		0504*			0603*			0805				1206			1505				
Standard Reel Packaging		All Paper		All Embossed			All Paper			Paper/Embossed				Paper/Embossed			All Embossed				
(L) Length	MM (in.)	1.00 ± .10 (.040 ± .004)		1.27 ± .25 (.050 ± .010)			1.60 ± .15 (.063 ± .006)			2.01 ± .20 (.079 ± .008)				3.20 ± .20 (.126 ± .008)			3.81 ± .25 (.150 ± .010)				
(W) Width	MM (in.)	.50 ± .10 (.020 ± .004)		1.02 ± .25 (.040 ± .010)			.81 ± .15 (.032 ± .006)			1.25 ± .20 (.049 ± .008)				1.60 ± .20 (.063 ± .008)			1.27 ± .25 (.050 ± .010)				
(T) Max. Thickness	MM (in.)	.60 (.024)		1.02 (.040)			.90 (.035)			1.30 (.051)				1.50 (.059)			1.27 (.050)				
(t) Terminal	MM (in.)	.25 ± .15 (.010 ± .006)		.38 ± .13 (.015 ± .005)			.35 ± .15 (.014 ± .006)			.50 ± .25 (.020 ± .010)				.50 ± .25 (.020 ± .010)			.50 ± .25 (.020 ± .010)				
WWDC		25	50	25	50	100	25	50	100	25	50	100	200	25	50	100	200	50	100	200	
Cap (pF)																					
	0.5	[Shaded]																			
	1.0	[Shaded]																			
	1.2	[Shaded]																			
	1.5	[Shaded]																			
	1.8	[Shaded]																			
	2.2	[Shaded]																			
	2.7	[Shaded]																			
	3.3	[Shaded]																			
	3.9	[Shaded]																			
	4.7	[Shaded]																			
	5.6	[Shaded]																			
	6.8	[Shaded]																			
	8.2	[Shaded]																			
	10	[Shaded]																			
	12	[Shaded]																			
	15	[Shaded]																			
	18	[Shaded]																			
	22	[Shaded]																			
	27	[Shaded]																			
	33	[Shaded]																			
	39	[Shaded]																			
	47	[Shaded]																			
	56	[Shaded]																			
	68	[Shaded]																			
	82	[Shaded]																			
	100	[Shaded]																			
	120	[Shaded]																			
	150	[Shaded]																			
	180	[Shaded]																			
	220	[Shaded]																			
	270	[Shaded]																			
	330	[Shaded]																			
	390	[Shaded]																			
	470	[Shaded]																			
	560	[Shaded]																			
	680	[Shaded]																			
	820	[Shaded]																			
	1000	[Shaded]																			
	1200	[Shaded]																			
	1500	[Shaded]																			
	1800	[Shaded]																			
	2200	[Shaded]																			
	2700	[Shaded]																			
	3300	[Shaded]																			
	3900	[Shaded]																			
	4700	[Shaded]																			
	5600	[Shaded]																			
	6800	[Shaded]																			
	8200	[Shaded]																			
	10000	[Shaded]																			

\*Reflow soldering only.

NOTES: For higher voltage chips, see pages 20 and 21.

[Shaded] = Paper Tape  
 [Hatched] = Embossed Tape

# COG (NP0) Dielectric



## Capacitance Range

### PREFERRED SIZES ARE SHADED

SIZE		1210				1808*			1812*				1825*			2220*			2225*		
Standard Reel Packaging		Paper/Embossed				All Embossed			All Embossed				All Embossed			All Embossed			All Embossed		
(L) Length	MM (in.)	3.20 ± .20 (.126 ± .008)				4.57 ± .25 (.180 ± .010)			4.50 ± .30 (.177 ± .012)				4.50 ± .30 (.177 ± .012)			5.7 ± .40 (.225 ± .016)			5.72 ± .25 (.225 ± .010)		
(W) Width	MM (in.)	2.50 ± .20 (.098 ± .008)				2.03 ± .25 (.080 ± .010)			3.20 ± .20 (.126 ± .008)				6.40 ± .40 (.252 ± .016)			5.0 ± .40 (.197 ± .016)			6.35 ± .25 (.250 ± .010)		
(T) Max. Thickness	MM (in.)	1.70 (.067)				1.52 (.060)			1.70 (.067)				1.70 (.067)			2.30 (.090)			1.70 (.067)		
(t) Terminal	MM (in.)	.50 ± .25 (.020 ± .010)				.64 ± .39 (.025 ± .015)			.61 ± .36 (.024 ± .014)				.61 ± .36 (.024 ± .014)			.64 ± .39 (.025 ± .015)			.64 ± .39 (.025 ± .015)		
WVDC		25	50	100	200	50	100	200	25	50	100	200	50	100	200	50	100	200	50	100	200
Cap (pF)	560 680 820	Shaded				Embossed			Embossed				Embossed			Embossed			Embossed		
	1000 1200 1500	Shaded				Embossed			Embossed				Embossed			Embossed			Embossed		
	1800 2200 2700	Shaded				Embossed			Embossed				Embossed			Embossed			Embossed		
	3300 3900 4700	Shaded				Embossed			Embossed				Embossed			Embossed			Embossed		
	5600 6800 8200	Shaded				Embossed			Embossed				Embossed			Embossed			Embossed		
Cap. (µF)	.010 .012 .015	Shaded				Embossed			Embossed				Embossed			Embossed			Embossed		
	.018 .022 .027	Shaded				Embossed			Embossed				Embossed			Embossed			Embossed		
	.033 .039 .047	Shaded				Embossed			Embossed				Embossed			Embossed			Embossed		
	.068 .082 .1	Shaded				Embossed			Embossed				Embossed			Embossed			Embossed		

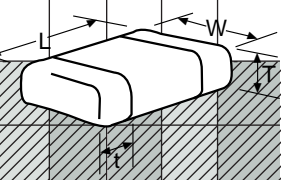

\*Reflow soldering only.

NOTES: For higher voltage chips, see pages 20 and 21.

= Paper Tape  
 = Embossed Tape



# X7R Dielectric

## General Specifications

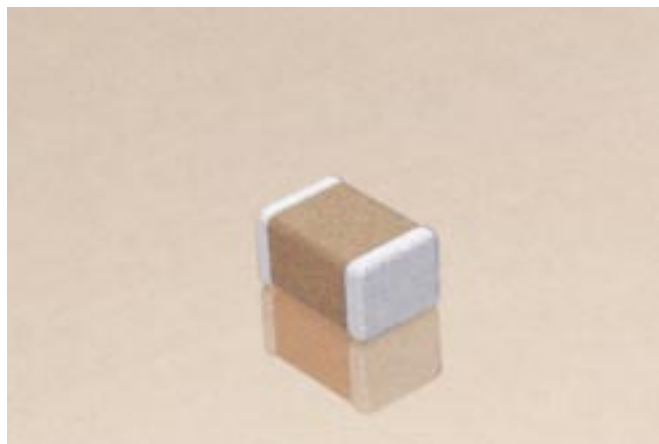

X7R formulations are called “temperature stable” ceramics and fall into EIA Class II materials. X7R is the most popular of these intermediate dielectric constant materials. Its temperature variation of capacitance is within  $\pm 15\%$  from  $-55^{\circ}\text{C}$  to  $+125^{\circ}\text{C}$ . This capacitance change is non-linear.

Capacitance for X7R varies under the influence of electrical operating conditions such as voltage and frequency.

X7R dielectric chip usage covers the broad spectrum of industrial applications where known changes in capacitance due to applied voltages are acceptable.

### PART NUMBER (see page 3 for complete part number explanation)

**0805**

**Size**  
(L" x W")

**5**

**Voltage**  
10V = Z  
16V = Y  
25V = 3  
50V = 5  
100V = 1

**C**

**Dielectric**  
X7R = C

**103**

**Capacitance Code**

**M**

**Capacitance Tolerance**  
Preferred  
M =  $\pm 20\%$   
K =  $\pm 10\%$

**A**

**Failure Rate**  
A = Not Applicable

**T**

**Terminations**  
T = Plated Ni and Solder

**2**

**Packaging**  
2 = 7" Reel  
4 = 13" Reel

**A**

**Special Code**  
A = Std. Product

### PERFORMANCE CHARACTERISTICS

<b>Capacitance Range</b>	100 pF to 2.2 $\mu\text{F}$ (1.0 $\pm 0.2$ Vrms, 1kHz)
<b>Capacitance Tolerances</b>	Preferred $\pm 10\%$ , $\pm 20\%$ others available: $\pm 5\%$ , $+80 -20\%$
<b>Operating Temperature Range</b>	$-55^{\circ}\text{C}$ to $+125^{\circ}\text{C}$
<b>Temperature Characteristic</b>	$\pm 15\%$ (0 VDC)
<b>Voltage Ratings</b>	10, 16, 25, 50, 100 VDC ( $+125^{\circ}\text{C}$ )
<b>Dissipation Factor</b>	For 50 volts and 100 volts: 2.5% max. For 25 volts: 3.0% max. For 16 volts: 3.5% max. For 10 volts: 5% max.
<b>Insulation Resistance</b> ( $+25^{\circ}\text{C}$ , RVDC)	100,000 megohms min. or 1000 $\text{M}\Omega$ - $\mu\text{F}$ min., whichever is less
<b>Insulation Resistance</b> ( $+125^{\circ}\text{C}$ , RVDC)	10,000 megohms min. or 100 $\text{M}\Omega$ - $\mu\text{F}$ min., whichever is less
<b>Dielectric Strength</b>	250% of rated voltage for 5 seconds at 50 mamp max. current
<b>Test Voltage</b>	1.0 $\pm 0.2$ Vrms
<b>Test Frequency</b>	1 KHz

## Typical Characteristic Curves\*\*

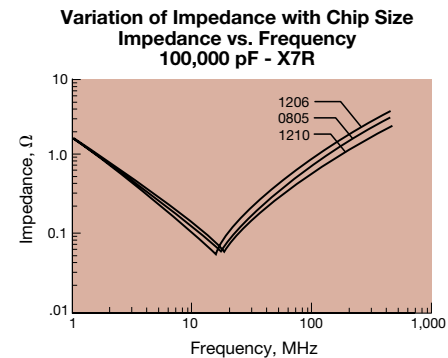
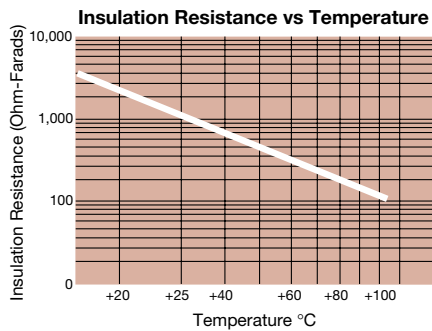
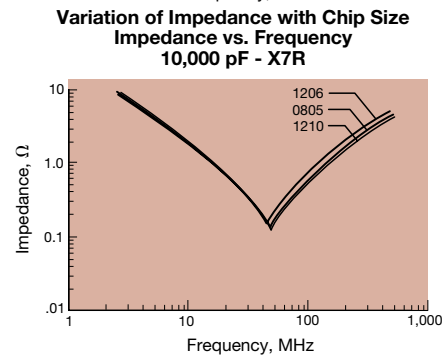
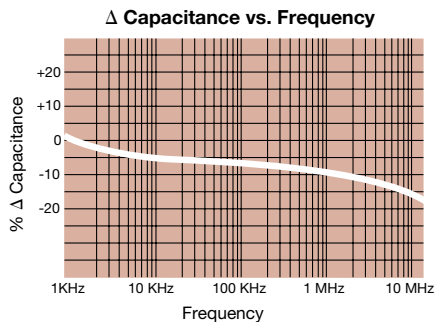
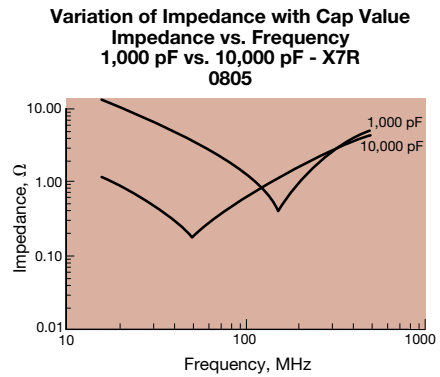
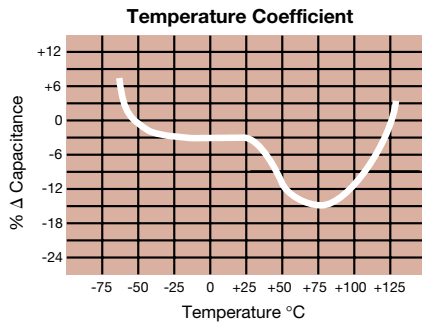

### SUMMARY OF CAPACITANCE RANGES VS. CHIP SIZE

Style	10V	16V	25V	50V	100V
0402*	—	100pF - 47nF	100pF - 6.8nF	100pF - 3.9nF	—
0504	—	—	—	100pF - .01μF	100pF - 3.3nF
0603*	100pF - 0.22μF	100pF - 0.1μF	100pF - 47nF	100pF - 15nF	100pF - 4.7nF
0805*	100pF - 2.2μF	100pF - 0.47μF	100pF - 0.22μF	100pF - 0.1μF	100pF - 22nF
1206*	1.5μF - 4.7μF	1nF - 1μF	1nF - 1.0μF	1nF - 0.22μF	1nF - 0.1μF
1210*	→	1nF - 1.8μF	1nF - 1μF	1nF - 0.22μF	1nF - 0.1μF
1505	→	→	→	1nF - 0.1μF	1nF - 27nF
1808	→	→	10nF - 0.33μF	10nF - 0.33μF	10nF - 0.1μF
1812*	→	→	→	10nF - 1μF	10nF - 0.47μF
1825*	→	→	→	10nF - 1μF	10nF - 0.47μF
2220	→	→	→	10nF - 1.5μF	10nF - 1.2μF
2225	→	→	→	10nF - 2.2μF	10nF - 1.5μF

\* Standard Sizes

\*\* For additional information on performance changes with operating conditions consult AVX's software SpiCap.

# X7R Dielectric

## Capacitance Range



### PREFERRED SIZES ARE SHADED

SIZE		0402*			0504*			0603*			0805			1206			1505																																																										
Standard Reel Packaging		All Paper			All Embossed			All Paper			Paper/Embossed			Paper/Embossed			All Embossed																																																										
(L) Length	MM (in.)	1.00 ± .10 (.040 ± .004)			1.27 ± .25 (.050 ± .010)			1.60 ± .15 (.063 ± .006)			2.01 ± .20 (.079 ± .008)			3.20 ± .20 (.126 ± .008)			3.81 ± .25 (.150 ± .010)																																																										
(W) Width	MM (in.)	.50 ± .10 (.020 ± .004)			1.02 ± .25 (.040 ± .010)			.81 ± .15 (.032 ± .006)			1.25 ± .20 (.049 ± .008)			1.60 ± .20 (.063 ± .008)			1.27 ± .25 (.050 ± .010)																																																										
(T) Max. Thickness	MM (in.)	.60 (.024)			1.02 (.040)			.90 (.035)			1.30 (.051)			1.50 (.059)			1.27 (.050)																																																										
(t) Terminal	MM (in.)	.25 ± .15 (.010 ± .006)			.38 ± .13 (.015 ± .005)			.35 ± .15 (.014 ± .006)			.50 ± .25 (.020 ± .010)			.50 ± .25 (.020 ± .010)			.50 ± .25 (.020 ± .010)																																																										
WVDC		16	25	50	50	100	10	16	25	50	100	10	16	25	50	100	10	16	25	50	100	50	100																																																				
Cap. (pF)																																																																											
		<table border="1"> <tr><td>100</td><td>120</td><td>150</td><td>180</td><td>220</td><td>270</td><td>330</td><td>390</td><td>470</td><td>560</td><td>680</td><td>820</td><td>1000</td><td>1200</td><td>1500</td><td>1800</td><td>2200</td><td>2700</td><td>3300</td><td>3900</td><td>4700</td><td>5600</td><td>6800</td><td>8200</td></tr> <tr><td>.010</td><td>.012</td><td>.015</td><td>.018</td><td>.022</td><td>.027</td><td>.033</td><td>.039</td><td>.047</td><td>.056</td><td>.068</td><td>.082</td><td>.10</td><td>.12</td><td>.15</td><td>.18</td><td>.22</td><td>.27</td><td>.33</td><td>.47</td><td>.56</td><td>.68</td><td>.82</td><td>1.0</td><td>1.2</td><td>1.5</td><td>1.8</td><td>2.2</td><td>4.7</td></tr> </table>																					100	120	150	180	220	270	330	390	470	560	680	820	1000	1200	1500	1800	2200	2700	3300	3900	4700	5600	6800	8200	.010	.012	.015	.018	.022	.027	.033	.039	.047	.056	.068	.082	.10	.12	.15	.18	.22	.27	.33	.47	.56	.68	.82	1.0	1.2	1.5	1.8	2.2	4.7
100	120	150	180	220	270	330	390	470	560	680	820	1000	1200	1500	1800	2200	2700	3300	3900	4700	5600	6800	8200																																																				
.010	.012	.015	.018	.022	.027	.033	.039	.047	.056	.068	.082	.10	.12	.15	.18	.22	.27	.33	.47	.56	.68	.82	1.0	1.2	1.5	1.8	2.2	4.7																																															

\*Reflow soldering only.

NOTES: For higher voltage chips, see pages 20 and 21.

= Paper Tape  
 = Embossed Tape

# X7R Dielectric

## Capacitance Range



PREFERRED SIZES ARE SHADED

SIZE		1210				1808*			1812*		1825*		2220*			2225*	
Standard Reel Packaging		Paper/Embossed				All Embossed			All Embossed		All Embossed		All Embossed			All Embossed	
(L) Length	MM (in.)	3.20 ± .20 (.126 ± .008)				4.57 ± .25 (.180 ± .010)			4.50 ± .30 (.177 ± .012)		4.50 ± .30 (.177 ± .012)		5.7 ± 0.4 (.225 ± .016)			5.72 ± .25 (.225 ± .010)	
(W) Width	MM (in.)	2.50 ± .20 (.098 ± .008)				2.03 ± .25 (.080 ± .010)			3.20 ± .20 (.126 ± .008)		6.40 ± .40 (.252 ± .016)		5.0 ± 0.4 (.197 ± .016)			6.35 ± .25 (.250 ± .010)	
(T) Max. Thickness	MM (in.)	1.70 (.067)				1.52 (.060)			1.70 (.067)		1.70 (.067)		2.30 (.090)			1.70 (.067)	
(t) Terminal	MM (in.)	.50 ± .25 (.020 ± .010)				.64 ± .39 (.025 ± .015)			.61 ± .36 (.024 ± .014)		.61 ± .36 (.024 ± .014)		.64 ± .39 (.025 ± .015)			.64 ± .39 (.025 ± .015)	
WVDC		16	25	50	100	25	50	100	50	100	50	100	50	100	200	50	100
Cap (pF)	1000 1200 1500	Shaded				Hatched			Hatched		Hatched		Hatched			Hatched	
	1800 2200 2700																
	3300 3900 4700																
	5600 6800 8200	Shaded				Hatched			Hatched		Hatched		Hatched			Hatched	
Cap. (µF)	.010 .012 .015																
	.018 .022 .027																
	.033 .039 .047	Shaded				Hatched			Hatched		Hatched		Hatched			Hatched	
	.056 .068 .082																
	.10 .12 .15																
	.18 .22 .27	Shaded				Hatched			Hatched		Hatched		Hatched			Hatched	
	.33 .39 .47																
	.56 .68 .82																
	1.0 1.2 1.5	Shaded				Hatched			Hatched		Hatched		Hatched			Hatched	
	1.8 2.2																

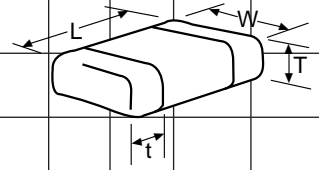

\*Reflow soldering only.

NOTES: For higher voltage chips, see pages 20 and 21.

= Paper Tape  
 = Embossed Tape

# Z5U Dielectric

## General Specifications



Z5U formulations are “general-purpose” ceramics which are meant primarily for use in limited temperature applications where small size and cost are important. Z5U show wide variations in capacitance under influence of environmental and electrical operating conditions.

Despite their capacitance instability, Z5U formulations are very popular because of their small size, low ESL, low ESR and excellent frequency response. These features are particularly important for decoupling application where only a minimum capacitance value is required.

### PART NUMBER (see page 3 for complete part number explanation)

**0805**

**Size**  
(L" x W")

**5**

**Voltage**  
25V = 3  
50V = 5

**E**

**Dielectric**  
Z5U = E

**104**

**Capacitance Code**

**Z**

**Capacitance Tolerance**  
Preferred  
Z = +80%  
-20%  
M = ±20%

**A**

**Failure Rate**  
A = Not Applicable

**T**

**Terminations**  
T = Plated Ni and Solder

**2**

**Packaging**  
2 = 7" Reel  
4 = 13" Reel

**A**

**Special Code**  
A = Std. Product

### PERFORMANCE CHARACTERISTICS

<b>Capacitance Range</b>	0.01 $\mu$ F to 1.0 $\mu$ F
<b>Capacitance Tolerances</b>	Preferred +80 -20% others available: $\pm$ 20%, +100 -0%
<b>Operating Temperature Range</b>	+10°C to +85°C
<b>Temperature Characteristic</b>	+22% to -56% max.
<b>Voltage Ratings</b>	25 and 50VDC (+85°C)
<b>Dissipation Factor</b>	4% max.
<b>Insulation Resistance (+25°C, RVDC)</b>	10,000 megohms min. or 1000 M $\Omega$ - $\mu$ F min., whichever is less
<b>Dielectric Strength</b>	250% of rated voltage for 5 seconds at 50 mamp max. current
<b>Test Voltage</b>	0.5 $\pm$ 0.2 Vrms
<b>Test Frequency</b>	1 KHz

## Typical Characteristic Curves\*\*

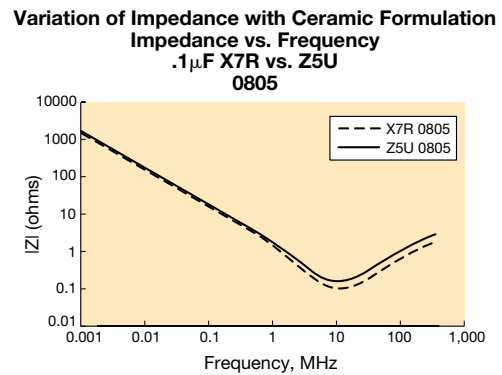
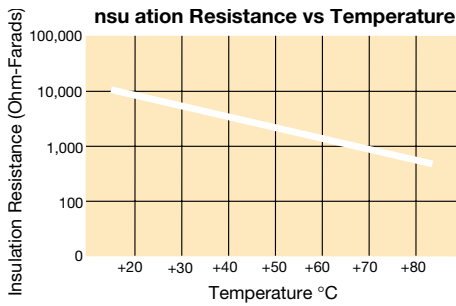
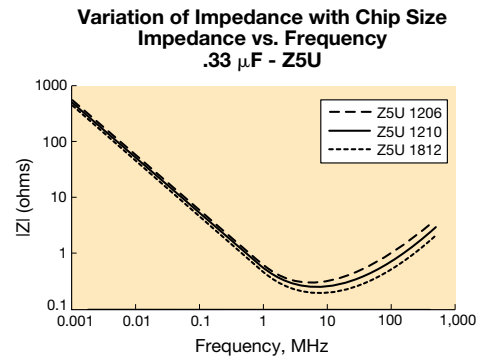
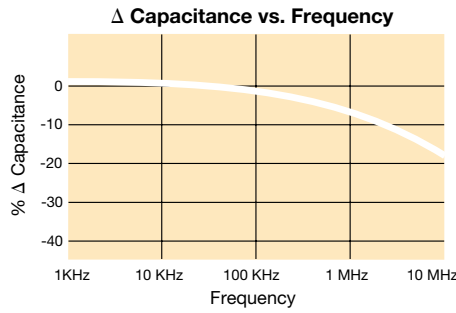
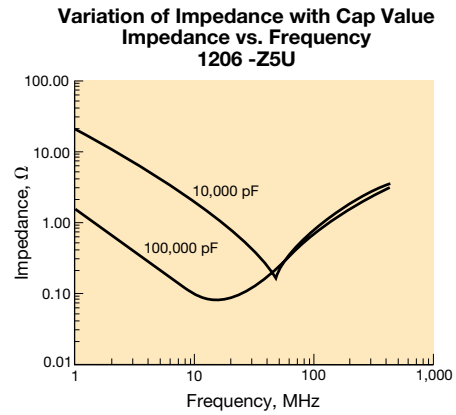
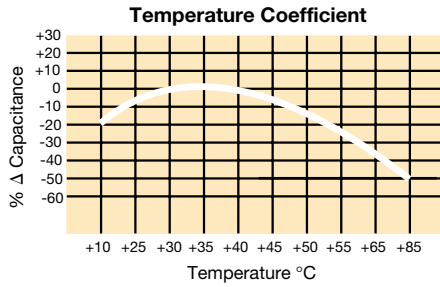

### SUMMARY OF CAPACITANCE RANGES VS. CHIP SIZE

Style	25V	50V
0603*	.01μF - .047μF	.01μF - .027μF
0805*	.01μF - .12μF	.01μF - 0.1μF
1206*	.01μF - .33μF	.01μF - .33μF
1210*	.01μF - .56μF	.01μF - .47μF
1808	.01μF - .56μF	.01μF - .47μF
1812*	.01μF - 1.0μF	.01μF - 1.0μF
1825*	.01μF - 1.0μF	.01μF - 1.0μF
2225	.01μF - 1.0μF	.01μF - 1.0μF

\* Standard Sizes

\*\* For additional information on performance changes with operating conditions consult AVX's software SpiCap.

# Z5U Dielectric

## Capacitance Range



### PREFERRED SIZES ARE SHADED

SIZE	□		□		□		□		
	0603*		0805		1206		1210		
Standard Reel Packaging	All Paper		Paper/Embossed		Paper/Embossed		Paper/Embossed		
(L) Length	MM (in.)	1.60 ± .15 (.063 ± .006)	2.01 ± .20 (.079 ± .008)	3.20 ± .20 (.126 ± .008)	3.20 ± .20 (.126 ± .008)	3.20 ± .20 (.126 ± .008)	3.20 ± .20 (.126 ± .008)	3.20 ± .20 (.126 ± .008)	
(W) Width	MM (in.)	.81 ± .15 (.032 ± .006)	1.25 ± .20 (.049 ± .008)	1.60 ± .20 (.063 ± .008)	1.60 ± .20 (.063 ± .008)	2.50 ± .20 (.098 ± .008)	2.50 ± .20 (.098 ± .008)	2.50 ± .20 (.098 ± .008)	
(T) Max. Thickness	MM (in.)	.90 (.035)	1.30 (.051)	1.50 (.059)	1.50 (.059)	1.70 (.067)	1.70 (.067)	1.70 (.067)	
(t) Terminal	MM (in.)	.35 ± .15 (.014 ± .006)	.50 ± .25 (.020 ± .010)	.50 ± .25 (.020 ± .010)	.50 ± .25 (.020 ± .010)	.50 ± .25 (.020 ± .010)	.50 ± .25 (.020 ± .010)	.50 ± .25 (.020 ± .010)	
WDC		25	50	25	50	25	50	25	50
Cap (µF)									
	.010								
	.012								
	.015								
	.018								
	.022								
	.027								
	.033								
	.039								
	.047								
	.056								
	.068								
	.082								
	.10								
	.12								
	.15								
	.18								
	.22								
	.27								
	.33								
	.39								
	.47								
	.56								
	.68								
	.82								
	1.0								
	1.5								

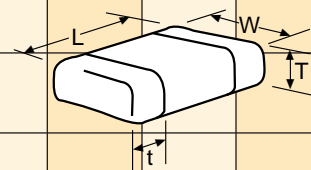

\*Reflow soldering only.

□ = Paper Tape  
 ▨ = Embossed Tape





NOTES: For low profile chips, see page 19.

# Z5U Dielectric

## Capacitance Range

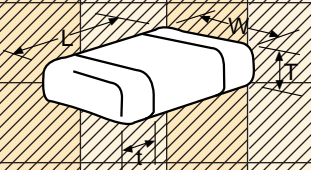
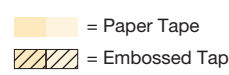

### PREFERRED SIZES ARE SHADED

							
SIZE		1808*	1812*	1825*	2225*		
Standard Reel Packaging		All Embossed		All Embossed			
(L) Length	MM (in.)	04.57 ± .25 (.180 ± .010)	4.50 ± .30 (.177 ± .012)	4.50 ± .30 (.177 ± .012)	5.72 ± .25 (.225 ± .010)		
(W) Width	MM (in.)	2.03 ± .25 (.080 ± .010)	3.20 ± .20 (.126 ± .008)	6.40 ± .40 (.252 ± .016)	6.35 ± .25 (.250 ± .010)		
(T) Max. Thickness	MM (in.)	1.52 (.060)	1.70 (.067)	1.70 (.067)	1.70 (.067)		
(t) Terminal	MM (in.)	.64 ± .39 (.025 ± .015)	.61 ± .36 (.024 ± .014)	.61 ± .36 (.024 ± .014)	.64 ± .39 (.025 ± .015)		
WVDC		25	50	25	50	25	50
Cap (μF)	.010						
	.012						
.015							
.018							
.022							
.027							
.033							
.039							
.047							
.056							
.068							
.082							
.10							
.12							
.15							
.18							
.22							
.27							
.33							
.39							
.47							
.56							
.68							
.82							
1.0							
1.5							

\*Reflow soldering only.

NOTES: For low profile chips, see page 19.



# Y5V Dielectric



## General Specifications

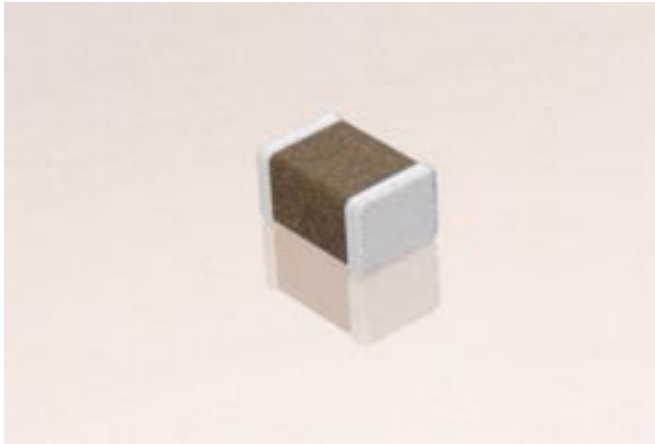

Y5V formulations are for general-purpose use in a limited temperature range. They have a wide temperature characteristic of +22% –82% capacitance change over the operating temperature range of –30°C to +85°C.

Y5V's high dielectric constant allows the manufacture of the highest capacitance value in a given case size.

These characteristics make Y5V ideal for decoupling applications within limited temperature range.

### PART NUMBER (see page 3 for complete part number explanation)

**0805**

**Size**  
(L" x W")

**3**

**Voltage**  
10V = Z  
16V = Y  
25V = 3  
50V = 5

**G**

**Dielectric**  
Y5V = G

**104**

**Capacitance Code**

**Z**

**Capacitance Tolerance**  
Z = +80 –20%

**A**

**Failure Rate**  
A = Not Applicable

**T**

**Terminations**  
T = Plated Ni and Solder

**2**

**Packaging**  
2 = 7" Reel  
4 = 13" Reel

**A**

**Special Code**  
A = Std. Product

### PERFORMANCE CHARACTERISTICS

<b>Capacitance Range</b>	2200 pF to 22 $\mu$ F
<b>Capacitance Tolerances</b>	+80 –20%
<b>Operating Temperature Range</b>	–30°C to +85°C
<b>Temperature Characteristic</b>	+22% to –82% max. within operating temperature
<b>Voltage Ratings</b>	10, 16, 25 and 50 VDC (+85°C)
<b>Dissipation Factor</b>	For 50 volts: 5.0% max. For 16 and 25 volts: 7% max. For 10 volts: 10% max.
<b>Insulation Resistance</b> (+25°C, RVDC)	10,000 megohms min. or 1000 M $\Omega$ - $\mu$ F min., whichever is less
<b>Dielectric Strength</b>	250% of rated voltage for 5 seconds at 50 mamp max. current
<b>Test Voltage</b>	1.0 Vrms $\pm$ 0.2 Vrms
<b>Test Frequency</b>	1 KHz

## Typical Characteristic Curves\*\*

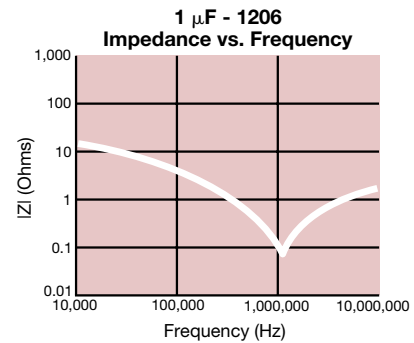
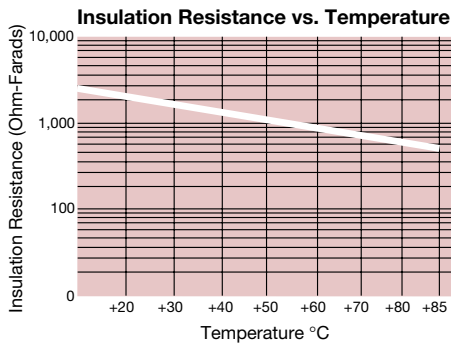
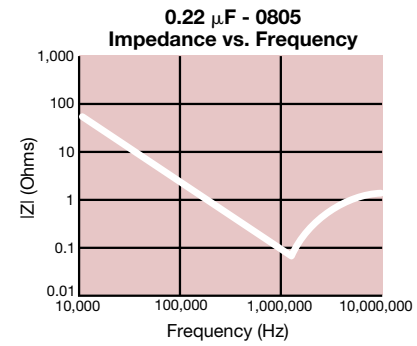
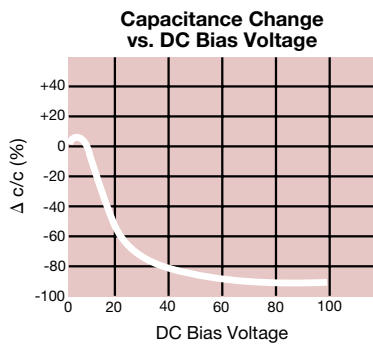
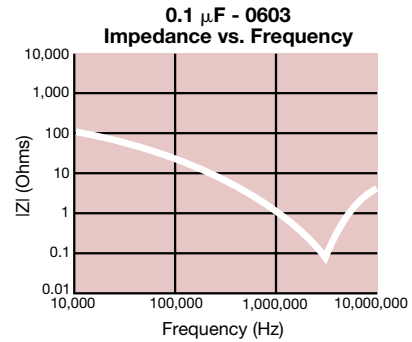
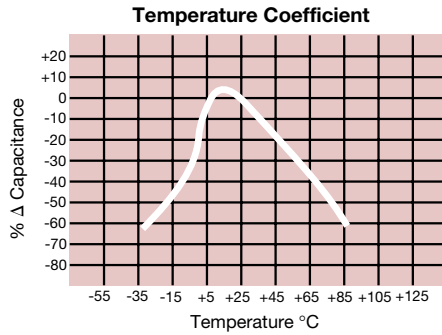

### SUMMARY OF CAPACITANCE RANGES VS. CHIP SIZE

Style	10V	16V	25V	50V
<b>0402*</b>	2.2nF - 0.1μF	2.2nF - 0.1μF	2.2nF - 22nF	2.2nF - 10nF
<b>0603*</b>	2.2nF - 1μF	2.2nF - 0.33μF	2.2nF - 0.22μF	2.2nF - 56nF
<b>0805*</b>	10nF - 4.7μF	10nF - 2.2μF	10nF - 1μF	10nF - 0.33μF
<b>1206*</b>	10nF - 10μF	10nF - 4.7μF	10nF - 2.2μF	10nF - 1μF
<b>1210*</b>	10nF - 22μF	0.1μF - 10μF	0.1μF - 4.7μF	0.1μF - 1μF
<b>1812*</b>	→	→	0.15μF - 1.5μF	1.5nF - 1.5μF
<b>1825*</b>	→	→	0.47μF - 1.5μF	0.47μF - 1.5μF
<b>2220</b>	—	—	—	1μF - 1.5μF
<b>2225</b>	→	→	0.68μF - 2.2μF	0.68μF - 1.5μF

\* Standard Sizes

\*\* For additional information on performance changes with operating conditions consult AVX's software SpiCap.

# Y5V Dielectric

## Capacitance Range



PREFERRED SIZES ARE SHADED

SIZE	0402*		0603*		0805		1206		1210		1812*		1825*		2220*		2225*	
	All Paper		All Paper		Paper/Embossed		Paper/Embossed		Paper/Embossed		All Embossed		All Embossed		All Embossed		All Embossed	
(L) Length	MM (in.)	1.00 ± .10 (.040 ± .004)	1.60 ± .15 (.063 ± .006)	2.01 ± .20 (.079 ± .008)	3.20 ± .20 (.126 ± .008)	3.20 ± .20 (.126 ± .008)	4.50 ± .30 (.177 ± .012)	4.50 ± .30 (.177 ± .012)	5.7 ± 0.4 (.225 ± .016)	5.7 ± 0.4 (.225 ± .016)	5.72 ± .25 (.225 ± .010)	5.72 ± .25 (.225 ± .010)	5.72 ± .25 (.225 ± .010)	5.72 ± .25 (.225 ± .010)	5.72 ± .25 (.225 ± .010)	5.72 ± .25 (.225 ± .010)	5.72 ± .25 (.225 ± .010)	5.72 ± .25 (.225 ± .010)
(W) Width	MM (in.)	.50 ± .10 (.020 ± .004)	.81 ± .15 (.032 ± .006)	1.25 ± .20 (.049 ± .008)	1.60 ± .20 (.063 ± .008)	2.50 ± .20 (.098 ± .008)	3.20 ± .20 (.126 ± .008)	6.40 ± .40 (.252 ± .016)	5.0 ± 0.4 (.197 ± .016)	6.35 ± .25 (.250 ± .010)	6.35 ± .25 (.250 ± .010)	6.35 ± .25 (.250 ± .010)	6.35 ± .25 (.250 ± .010)	6.35 ± .25 (.250 ± .010)	6.35 ± .25 (.250 ± .010)	6.35 ± .25 (.250 ± .010)	6.35 ± .25 (.250 ± .010)	6.35 ± .25 (.250 ± .010)
(T) Max. Thickness	MM (in.)	.60 (.024)	.90 (.035)	1.30 (.051)	1.50 (.059)	1.70 (.067)	1.70 (.067)	2.30 (.090)	2.30 (.090)	2.30 (.090)	2.30 (.090)	2.30 (.090)	2.30 (.090)	2.30 (.090)	2.30 (.090)	2.30 (.090)	2.30 (.090)	2.30 (.090)
(t) Terminal	MM (in.)	.25 ± .15 (.010 ± .006)	.35 ± .15 (.014 ± .006)	.50 ± .25 (.020 ± .010)	.50 ± .25 (.020 ± .010)	.50 ± .25 (.020 ± .010)	.61 ± .36 (.024 ± .014)	.61 ± .36 (.024 ± .014)	.64 ± .39 (.025 ± .015)	.64 ± .39 (.025 ± .015)	.64 ± .39 (.025 ± .015)	.64 ± .39 (.025 ± .015)	.64 ± .39 (.025 ± .015)	.64 ± .39 (.025 ± .015)	.64 ± .39 (.025 ± .015)	.64 ± .39 (.025 ± .015)	.64 ± .39 (.025 ± .015)	.64 ± .39 (.025 ± .015)
WVDC		10 16 25 50	10 16 25 50	10 16 25 50	10 16 25 50	10 16 25 50	25 50	25 50	25 50	25 50	25 50	25 50	25 50	25 50	25 50	25 50	25 50	25 50
Cap (pF)	2200 2700 3300																	
	3900 4700 5600																	
	6800 8200																	
Cap (µF)	.01 .012 .015																	
	.018 .022 .027																	
	.033 .039 .047																	
	.056 .068 .082																	
	.10 .12 .15																	
	.18 .22 .27																	
	.33 .39 .47																	
	.56 .68 .82																	
	1.0 1.2 1.5																	
	1.8 2.2 2.7																	
	3.3 3.9 4.7																	
	5.6 6.8 8.2																	
	10.0 12.0 15.0																	
	18.0 22.0																	

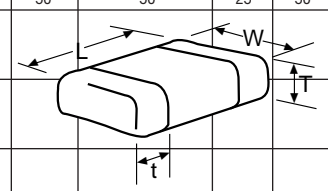

\*Reflow soldering only.

NOTES: For low profile product, see page 19.

= Paper Tape  
 = Embossed Tape

# Low Profile Chips



## Z5U & Y5V Dielectric

**PART NUMBER** (see page 3 for complete information and options)

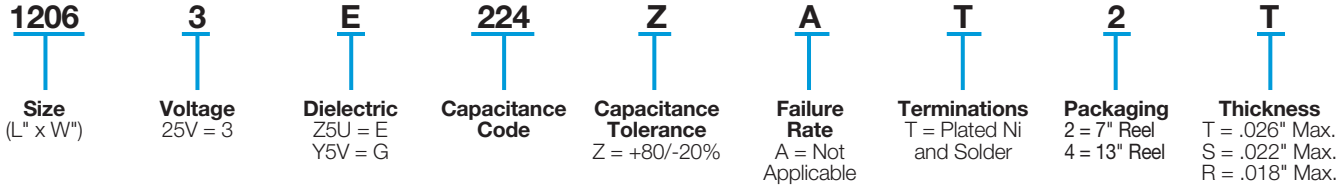

### PERFORMANCE CHARACTERISTICS

<b>Capacitance Range</b>	Z5U: .01 – .33µF; Y5V: .01 – .47µF
<b>Capacitance Tolerances</b>	+80, -20%
<b>Operating Temperature Range</b>	Z5U: +10°C to +85°C; Y5V: -30°C to +85°C
<b>Temperature Characteristic</b>	Z5U: +22%, -56%; Y5V: +22%, -82%
<b>Voltage Ratings</b>	25 VDC
<b>Dissipation Factor</b> 25°C, .5 Vrms, 1kHz	Z5U: 4%; Y5V: 7%
<b>Insulation Resistance</b>	10,000 megohms min. or 1000 MΩ - µF whichever is less
<b>Dielectric Strength for 5 seconds at 50 mamp max. current</b>	250% of rated VDC
<b>Test Voltage</b>	Z5U: 0.5 ± 0.2 Vrms Y5V: 1.0 Vrms ± 0.2 Vrms
<b>Test Frequency</b>	1 KHz

### CAPACITANCE VALUES FOR VARIOUS THICKNESSES

#### Z5U

SIZE	0805			1206			1210		
(L) Length	MM (in.) 2.01 ± .20 (.079 ± .008)			3.2 ± .2 (.126 ± .008)			3.2 ± .2 (.126 ± .008)		
(W) Width	1.25 ± .20 (.049 ± .008)			1.6 ± .2 (.063 ± .008)			2.5 ± .2 (.098 ± .008)		
(t) Terminal	.50 ± .25 (.020 ± .010)			.50 ± .25 (.020 ± .010)			.50 ± .25 (.020 ± .010)		
(T) Thickness Max.	.46 (.018)	.56 (.022)	.66 (.026)	.46 (.018)	.56 (.022)	.66 (.026)	.46 (.018)	.56 (.022)	.66 (.026)
Cap (µF)	.01, .012, .015, .018, .022, .027, .033, .039, .047, .056, .068, .082, .1, .12, .15, .18, .22, .27, .33, .39, .47								

#### Y5V

SIZE	0805			1206			1210		
(L) Length	MM (in.) 2.01 ± .20 (.079 ± .008)			3.2 ± .2 (.126 ± .008)			3.2 ± .2 (.126 ± .008)		
(W) Width	1.25 ± .20 (.049 ± .008)			1.6 ± .2 (.063 ± .008)			2.5 ± .2 (.098 ± .008)		
(t) Terminal	.50 ± .25 (.020 ± .010)			.50 ± .25 (.020 ± .010)			.50 ± .25 (.020 ± .010)		
(T) Thickness Max.	.46 (.018)	.56 (.022)	.66 (.026)	.46 (.018)	.56 (.022)	.66 (.026)	.46 (.018)	.56 (.022)	.66 (.026)
Cap (µF)	.01, .012, .015, .018, .022, .027, .033, .039, .047, .056, .068, .082, .1, .12, .15, .18, .22, .27, .33, .39, .47								

= Paper Tape

= Paper Tape



# High Voltage Chips

For 500V to 5000V Applications

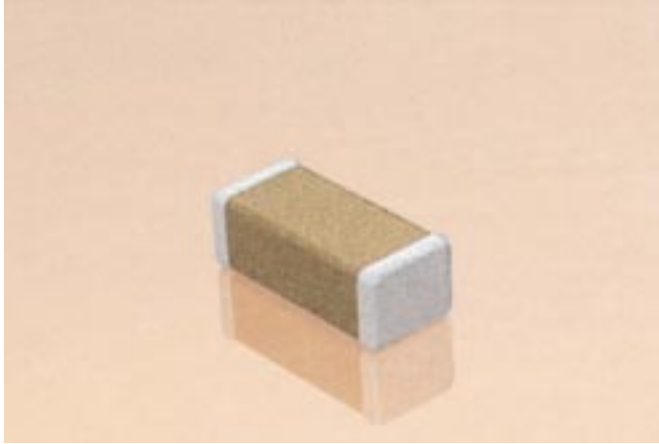

High value, low leakage and small size are difficult parameters to obtain in capacitors for high voltage systems. AVX special high voltage MLC chips capacitors meet these performance characteristics and are designed for applications such as snubbers in high frequency power converters, resonators in SMPS, and high voltage coupling/DC blocking. These high voltage chip designs exhibit low ESRs at high frequencies.

High voltage chips are typically larger than standard voltage rated chips. These larger sizes require that special precautions be taken in applying these chips in surface mount assemblies. This is due to differences in the coefficient of thermal expansion (CTE) between the substrate materials and chip capacitors.

## PART NUMBER (see page 3 for complete information and options)

<b>1808</b>	<b>A</b>	<b>A</b>	<b>271</b>	<b>K</b>	<b>A</b>	<b>1</b>	<b>1</b>	<b>A</b>
<b>AVX Style</b>	<b>Voltage</b>	<b>Temperature Coefficient</b>	<b>Capacitance Code</b>	<b>Capacitance Tolerance</b>	<b>Failure Rate</b>	<b>Termination</b>	<b>Packaging</b>	<b>Special Code</b>
1206 1210 1808 1812 1825 2225 3640	500V = 7 600V = C 1000V = A 1500V = S 2000V = G 2500V = W 3000V = H 4000V = J 5000V = K	COG = A X7R = C	(2 significant digits + no. of zeros) Examples: 10pF = 100 100pF = 101 1,000pF = 102 22,000pF = 223 220,000pF = 224 1µF = 105	COG: J= ±5% K= ±10% M= ±20% X7R: K= ±10% M= ±20% Z= +80% - 20%	A=Not applicable	1= Pd/Ag T= Plated Ni and Solder	1 = 7" Reel Embossed Tape 3 = 13" Reel Embossed Tape 9 = Bulk	A = Standard



# High Voltage Chips



For 500V to 5000V Applications

## C0G (NP0) Dielectric

### PERFORMANCE CHARACTERISTICS

Capacitance Range	100 pF to .047 $\mu$ F (25°C, 1.0 $\pm$ 0.2 Vrms at 1kHz)
Capacitance Tolerances	$\pm$ 5%, $\pm$ 10%, $\pm$ 20%
Dissipation Factor	0.1% max. (+25°C, 1.0 $\pm$ 0.2 Vrms, 1kHz)
Operating Temperature Range	-55°C to +125°C
Temperature Characteristic	0 $\pm$ 30 ppm/°C (0 VDC)
Voltage Ratings	500, 600, 1000, 1500, 2000, 2500, 3000, 4000 & 5000 VDC (+125°C)
Insulation Resistance (+25°C, at 500 VDC)	100,000 megohms min. or 1000 M $\Omega$ - $\mu$ F min., whichever is less
Insulation Resistance (+125°C, at 500 VDC)	10,000 megohms min. or 100 M $\Omega$ - $\mu$ F min., whichever is less
Dielectric Strength	120% rated voltage for 5 seconds at 50 mamp max. current
Thickness	Dependent upon size, voltage, and capacitance value

### C0G (NP0) MAXIMUM CAPACITANCE VALUES

VOLTAGE	1206	1210	1808	1812	1825	2225	3640
500	680 pF	1500 pF	3300 pF	5600 pF	.012 $\mu$ F	.018 $\mu$ F	—
600	680 pF	1500 pF	3300 pF	5600 pF	.012 $\mu$ F	.018 $\mu$ F	.047 $\mu$ F
1000	330 pF	680 pF	1500 pF	2200 pF	5600 pF	8200 pF	.018 $\mu$ F
1500	120 pF	270 pF	330 pF	560 pF	1500 pF	1800 pF	5600 pF
2000	68 pF	120 pF	270 pF	470 pF	1200 pF	1500 pF	4700 pF
2500	—	—	100 pF	220 pF	560 pF	820 pF	2700 pF
3000	—	—	82 pF	180 pF	270 pF	680 pF	2200 pF
4000	—	—	—	—	—	—	1000 pF
5000	—	—	—	—	—	—	680 pF

## X7R Dielectric

### PERFORMANCE CHARACTERISTICS

Capacitance Range	1000 pF to 0.56 $\mu$ F (25°C, 1.0 $\pm$ 0.2 Vrms at 1kHz)
Capacitance Tolerances	$\pm$ 10%, $\pm$ 20%, +80% -20%
Dissipation Factor	2.5% max. (+25°C, 1.0 $\pm$ 0.2 Vrms, 1kHz)
Operating Temperature Range	-55°C to +125°C
Temperature Characteristic	$\pm$ 15% (0 VDC)
Voltage Ratings	500, 600, 1000, 1500, 2000, 2500, 3000 & 4000 VDC (+125°C)
Insulation Resistance (+25°C, at 500 VDC)	100,000 megohms min. or 1000 M $\Omega$ - $\mu$ F min., whichever is less
Insulation Resistance (+125°C, at 500 VDC)	10,000 megohms min. or 100 M $\Omega$ - $\mu$ F min., whichever is less
Dielectric Strength	120% rated voltage for 5 seconds at 50 mamp max. current
Thickness	Dependent upon size, voltage, and capacitance value

### X7R MAXIMUM CAPACITANCE VALUES

VOLTAGE	1206	1210	1808	1812	1825	2225	3640
500	.015 $\mu$ F	.027 $\mu$ F	—	.056 $\mu$ F	—	—	—
600	.015 $\mu$ F	.027 $\mu$ F	.039 $\mu$ F	.068 $\mu$ F	.15 $\mu$ F	.22 $\mu$ F	.56 $\mu$ F
1000	4700 pF	8200 pF	.015 $\mu$ F	.027 $\mu$ F	.068 $\mu$ F	.082 $\mu$ F	.22 $\mu$ F
1500	1200 pF	2700 pF	2700 pF	5600 pF	.012 $\mu$ F	.018 $\mu$ F	.056 $\mu$ F
2000	470 pF	820 pF	1500 pF	3300 pF	6800 pF	.010 $\mu$ F	.027 $\mu$ F
2500	—	—	1200 pF	2200 pF	5600 pF	8200 pF	.022 $\mu$ F
3000	—	—	—	—	—	4700 pF	.018 $\mu$ F
4000	—	—	—	—	—	—	5600 pF



# General Specifications



## Environmental

### THERMAL SHOCK

#### Specification

##### Appearance

No visual defects

##### Capacitance Variation

COG (NP0):  $\pm 2.5\%$  or  $\pm .25\text{pF}$ , whichever is greater  
 X7R:  $\leq \pm 7.5\%$   
 Z5U:  $\leq \pm 20\%$   
 Y5V:  $\leq \pm 20\%$

##### Q, Tan Delta

To meet initial requirement

##### Insulation Resistance

COG (NP0), X7R: To meet initial requirement  
 Z5U, Y5V:  $\geq \text{Initial Value} \times 0.1$

##### Dielectric Strength

No problem observed

#### Measuring Conditions

Step	Temperature °C	Time (minutes)
1	COG (NP0), X7R: $-55^\circ \pm 2^\circ$	30 $\pm$ 3
	Z5U: $+10^\circ \pm 2^\circ$	
	Y5V: $-30^\circ \pm 2^\circ$	
2	Room Temperature	# 3
3	COG (NP0), X7R: $+125^\circ \pm 2^\circ$	30 $\pm$ 3
	Z5U, Y5V: $+85^\circ \pm 2^\circ$	
4	Room Temperature	# 3

Repeat for 5 cycles and measure after 48 hours  $\pm$  4 hours (24 hours for COG (NP0)) at room temperature.

### IMMERSION

#### Specification

##### Appearance

No visual defects

##### Capacitance Variation

COG (NP0):  $\pm 2.5\%$  or  $\pm .25\text{pF}$ , whichever is greater  
 X7R:  $\leq \pm 7.5\%$   
 Z5U:  $\leq \pm 20\%$   
 Y5V:  $\leq \pm 20\%$

##### Q, Tan Delta

To meet initial requirement

##### Insulation Resistance

COG (NP0), X7R: To meet initial requirement  
 Z5U, Y5V:  $\geq \text{Initial Value} \times 0.1$

##### Dielectric Strength

No problem observed

#### Measuring Conditions

Step	Temperature °C	Time (minutes)
1	+65 $\pm$ 5/-0	15 $\pm$ 2
	Pure Water	
2	0 $\pm$ 3	15 $\pm$ 2
	NaCl solution	

Repeat cycle 2 times and wash with water and dry.  
 Store at room temperature for 48  $\pm$  4 hours (24 hours for COG (NP0)) and measure.

### MOISTURE RESISTANCE

#### Specification

##### Appearance

No visual defects

##### Capacitance Variation

COG (NP0):  $\pm 5\%$  or  $\pm .5\text{pF}$ , whichever is greater  
 X7R:  $\leq \pm 10\%$   
 Z5U:  $\leq \pm 30\%$   
 Y5V:  $\leq \pm 30\%$

##### Q, Tan Delta

COG (NP0):  $\geq 30\text{pF}$  ..... Q  $\geq 350$   
 $\geq 10\text{pF}$ ,  $< 30\text{pF}$  ..... Q  $\geq 275+5C/2$   
 $< 10\text{pF}$  ..... Q  $\geq 200+10C$   
 X7R: Initial requirement + .5%  
 Z5U: Initial requirement + 1%  
 Y5V: Initial requirement + 2%

##### Insulation Resistance

$\geq \text{Initial Value} \times 0.3$

#### Measuring Conditions

Step	Temp. °C	Humidity %	Time (hrs)
1	+25- $\rightarrow$ +65	90-98	2.5
2	+65	90-98	3.0
3	+65- $\rightarrow$ +25	80-98	2.5
4	+25- $\rightarrow$ +65	90-98	2.5
5	+65	90-98	3.0
6	+65- $\rightarrow$ +25	80-98	2.5
7	+25	90-98	2.0
7a	-10	uncontrolled	-
7b	+25	90-98	-

Repeat 20 cycles (1-7) and store for 48 hours (24 hours for COG (NP0)) at room temperature before measuring. Steps 7a & 7b are done on any 5 out of first 9 cycles.



## Environmental

### STEADY STATE HUMIDITY

#### (No Load)

##### Specification

###### Appearance

No visual defects

###### Capacitance Variation

C0G (NP0):  $\pm 5\%$  or  $\pm .5\text{pF}$ , whichever is greater  
X7R:  $\leq \pm 10\%$   
Z5U:  $\leq \pm 30\%$   
Y5V:  $\leq \pm 30\%$

###### Q, Tan Delta

C0G (NP0):  $\geq 30\text{pF}$  .....Q  $\geq 350$   
 $\geq 10\text{pF}$ ,  $< 30\text{pF}$  .....Q  $\geq 275+5C/2$   
 $< 10\text{pF}$  .....Q  $\geq 200+10C$   
X7R: Initial requirement + .5%  
Z5U: Initial requirement + 1%  
Y5V: Initial requirement + 2%

###### Insulation Resistance

$\geq$  Initial Value x 0.3

##### Measuring Conditions

Store at  $85 \pm 5\%$  relative humidity and  $85^\circ\text{C}$  for 1000 hours, without voltage. Remove from test chamber and stabilize at room temperature and humidity for  $48 \pm 4$  hours ( $24 \pm 2$  hours for C0G (NP0)) before measuring.

Charge and discharge currents must be less than 50ma.

### LOAD HUMIDITY

##### Specification

###### Appearance

No visual defects

###### Capacitance Variation

C0G (NP0):  $\pm 5\%$  or  $\pm .5\text{pF}$ , whichever is greater  
X7R:  $\leq \pm 10\%$   
Z5U:  $\leq \pm 30\%$   
Y5V:  $\leq \pm 30\%$

###### Q, Tan Delta

C0G (NP0):  $\geq 30\text{pF}$  .....Q  $\geq 350$   
 $\geq 10\text{pF}$ ,  $< 30\text{pF}$  .....Q  $\geq 275+5C/2$   
 $< 10\text{pF}$  .....Q  $\geq 200+10C$   
X7R: Initial requirement + .5%  
Z5U: Initial requirement + 1%  
Y5V: Initial requirement + 2%

###### Insulation Resistance

C0G (NP0), X7R: To meet initial value x 0.3  
Z5U, Y5V:  $\geq$  Initial Value x 0.1

Charge devices with rated voltage in test chamber set at  $85 \pm 5\%$  relative humidity and  $85^\circ\text{C}$  for 1000 (+48,-0) hours. Remove from test chamber and stabilize at room temperature and humidity for  $48 \pm 4$  hours ( $24 \pm 2$  hours for C0G (NP0)) before measuring.

Charge and discharge currents must be less than 50ma.

### LOAD LIFE

##### Specification

###### Appearance

No visual defects

###### Capacitance Variation

C0G (NP0):  $\pm 3\%$  or  $\pm .3\text{pF}$ , whichever is greater  
X7R:  $\leq \pm 10\%$   
Z5U:  $\leq \pm 30\%$   
Y5V:  $\leq \pm 30\%$

###### Q, Tan Delta

C0G (NP0):  $\geq 30\text{pF}$  .....Q  $\geq 350$   
 $\geq 10\text{pF}$ ,  $< 30\text{pF}$  .....Q  $\geq 275+5C/2$   
 $< 10\text{pF}$  .....Q  $\geq 200+10C$   
X7R: Initial requirement + .5%  
Z5U: Initial requirement + 1%  
Y5V: Initial requirement + 2%

###### Insulation Resistance

C0G (NP0), X7R: To meet initial value x 0.3  
Z5U, Y5V:  $\geq$  Initial Value x 0.1

Charge devices with twice rated voltage in test chamber set at  $+125^\circ\text{C} \pm 2^\circ\text{C}$  for C0G (NP0) and X7R,  $+85^\circ \pm 2^\circ\text{C}$  for Z5U, and Y5V for 1000 (+48,-0) hours. Remove from test chamber and stabilize at room temperature for  $48 \pm 4$  hours ( $24 \pm 2$  hours for C0G (NP0)) before measuring.

Charge and discharge currents must be less than 50ma.



## Mechanical

### END TERMINATION ADHERENCE

#### Specification

No evidence of peeling of end terminal

#### Measuring Conditions

After soldering devices to circuit board apply 5N (0.51kg f) for  $10 \pm 1$  seconds, please refer to Figure 1.

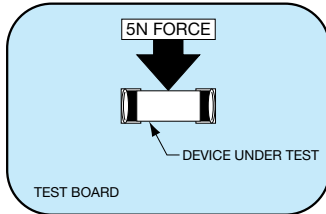

Figure 1.  
Terminal Adhesion

### RESISTANCE TO VIBRATION

#### Specification

##### Appearance:

No visual defects

##### Capacitance

Within specified tolerance

##### Q, Tan Delta

To meet initial requirement

##### Insulation Resistance

COG (NP0), X7R  $\geq$  Initial Value x 0.3  
Z5U, Y5V  $\geq$  Initial Value x 0.1

#### Measuring Conditions

##### Vibration Frequency

10-2000 Hz

##### Maximum Acceleration

20G

##### Swing Width

1.5mm

##### Test Time

X, Y, Z axis for 2 hours each, total 6 hours of test

### SOLDERABILITY

#### Specification

$\geq 95\%$  of each termination end should be covered with fresh solder

#### Measuring Conditions

Dip device in eutectic solder at  $230 \pm 5^\circ\text{C}$  for  $2 \pm .5$  seconds

### BEND STRENGTH

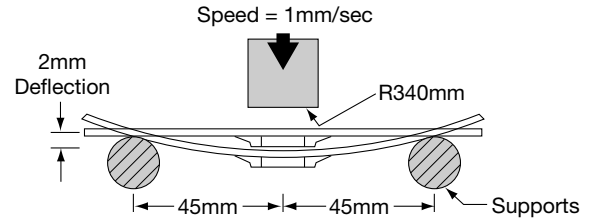

Figure 2. Bend Strength

#### Specification

##### Appearance:

No visual defects

##### Capacitance Variation

COG (NP0):  $\pm 5\%$  or  $\pm .5\text{pF}$ , whichever is larger

X7R:  $\leq \pm 12\%$

Z5U:  $\leq \pm 30\%$

Y5V:  $\leq \pm 30\%$

##### Insulation Resistance

COG (NP0):  $\geq$  Initial Value x 0.3

X7R:  $\geq$  Initial Value x 0.3

Z5U:  $\geq$  Initial Value x 0.1

Y5V:  $\geq$  Initial Value x 0.1

#### Measuring Conditions

Please refer to Figure 2

##### Deflection:

2mm

##### Test Time:

30 seconds

### RESISTANCE TO SOLDER HEAT

#### Specification

##### Appearance:

No serious defects,  $<25\%$  leaching of either end terminal

##### Capacitance Variation

COG (NP0):  $\pm 2.5\%$  or  $\pm 2.5\text{pF}$ , whichever is greater

X7R:  $\leq \pm 7.5\%$

Z5U:  $\leq \pm 20\%$

Y5V:  $\leq \pm 20\%$

##### Q, Tan Delta

To meet initial requirement

##### Insulation Resistance

To meet initial requirement

##### Dielectric Strength

No problem observed

#### Measuring Conditions

Dip device in eutectic solder at  $260^\circ\text{C}$ , for 1 minute. Store at room temperature for 48 hours (24 hours for COG (NP0)) before measuring electrical parameters.

Part sizes larger than  $3.20\text{mm} \times 2.49\text{mm}$  are reheated at  $150^\circ\text{C}$  for  $30 \pm 5$  seconds before performing test.

# MIL-PRF-55681/Chips



## Part Number Example

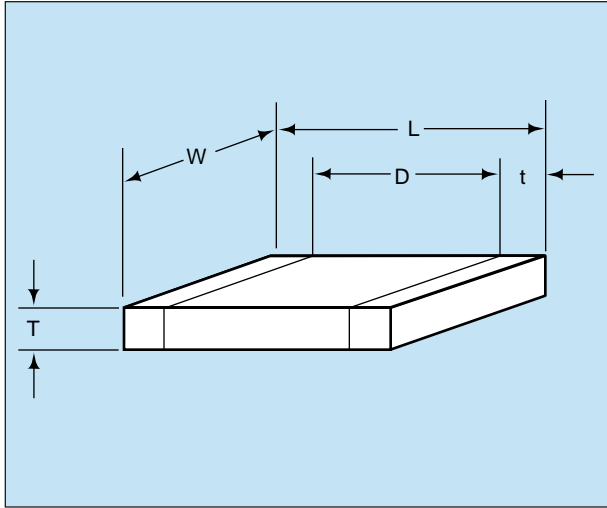

## MILITARY DESIGNATION PER MIL-PRF-55681

### Part Number Example

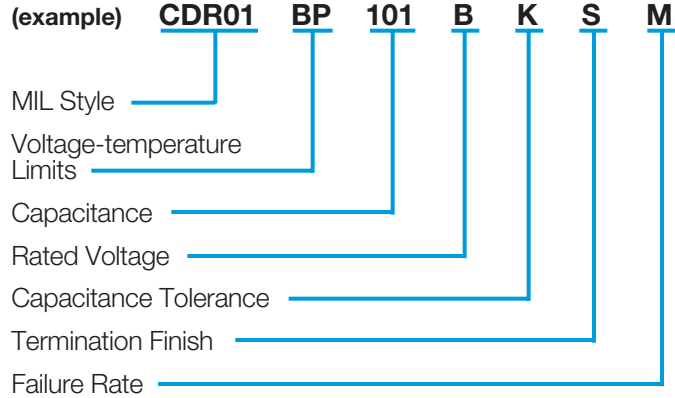

**MIL Style:** CDR01, CDR02, CDR03, CDR04, CDR05, CDR06

**Voltage Temperature Limits:**

BP =  $0 \pm 30$  ppm/°C without voltage;  $0 \pm 30$  ppm/°C with rated voltage from -55°C to +125°C

BX =  $\pm 15\%$  without voltage; +15 –25% with rated voltage from -55°C to +125°C

**Capacitance:** Two digit figures followed by multiplier (number of zeros to be added) e.g., 101 = 100 pF

**Rated Voltage:** A = 50V, B = 100V

**Capacitance Tolerance:** J  $\pm 5\%$ , K  $\pm 10\%$ , M  $\pm 20\%$

**Termination Finish:**

M = Palladium Silver  
 N = Silver Nickel Gold  
 S = Solder-coated

U = Base Metallization/Barrier Metal/Solder Coated\*  
 W = Base Metallization/Barrier Metal/Tinned (Tin or Tin/Lead Alloy)

\*Solder shall have a melting point of 200°C or less.

**Failure Rate Level:** M = 1.0%, P = .1%, R = .01%, S = .001%

**Packaging:** Bulk is standard packaging. Tape and reel per RS481 is available upon request.

## CROSS REFERENCE: AVX/MIL-PRF-55681/CDR01 THRU CDR06\*

Per MIL-PRF-55681	AVX Style	Length (L)	Width (W)	Thickness (T)		D		Termination Band (t)	
				Max.	Min.	Max.	Min.	Max.	Min.
CDR01	0805	.080 ± .015	.050 ± .015	.055	.020	—	.030	—	.010
CDR02	1805	.180 ± .015	.050 ± .015	.055	.020	—	—	.030	.010
CDR03	1808	.180 ± .015	.080 ± .018	.080	.020	—	—	.030	.010
CDR04	1812	.180 ± .015	.125 ± .015	.080	.020	—	—	.030	.010
CDR05	1825	.180 <sup>+.020</sup> <sub>-.015</sub>	.250 <sup>+.020</sup> <sub>-.015</sub>	.080	.020	—	—	.030	.010
CDR06	2225	.225 ± .020	.250 ± .020	.080	.020	—	—	.030	.010

\*For CDR11, 12, 13, and 14 see AVX Microwave Chip Capacitor Catalog

# MIL-PRF-55681/Chips

## Military Part Number Identification

### CDR01 thru CDR06



#### CDR01 thru CDR06 to MIL-PRF-55681

Military Type Designation	Capacitance in pF	Capacitance tolerance	Rated temperature and voltage-temperature limits	WVDC
<b>AVX Style 0805/CDR01</b>				
CDR01BP100B---	10	J,K	BP	100
CDR01BP120B---	12	J	BP	100
CDR01BP150B---	15	J,K	BP	100
CDR01BP180B---	18	J	BP	100
CDR01BP220B---	22	J,K	BP	100
CDR01BP270B---	27	J	BP	100
CDR01BP330B---	33	J,K	BP	100
CDR01BP390B---	39	J	BP	100
CDR01BP470B---	47	J,K	BP	100
CDR01BP560B---	56	J	BP	100
CDR01BP680B---	68	J,K	BP	100
CDR01BP820B---	82	J	BP	100
CDR01BP101B---	100	J,K	BP	100
CDR01B--121B---	120	J,K	BP,BX	100
CDR01B--151B---	150	J,K	BP,BX	100
CDR01B--181B---	180	J,K	BP,BX	100
CDR01BX221B---	220	K,M	BX	100
CDR01BX271B---	270	K	BX	100
CDR01BX331B---	330	K,M	BX	100
CDR01BX391B---	390	K	BX	100
CDR01BX471B---	470	K,M	BX	100
CDR01BX561B---	560	K	BX	100
CDR01BX681B---	680	K,M	BX	100
CDR01BX821B---	820	K	BX	100
CDR01BX102B---	1000	K,M	BX	100
CDR01BX122B---	1200	K	BX	100
CDR01BX152B---	1500	K,M	BX	100
CDR01BX182B---	1800	K	BX	100
CDR01BX222B---	2200	K,M	BX	100
CDR01BX272B---	2700	K	BX	100
CDR01BX332B---	3300	K,M	BX	100
CDR01BX392A---	3900	K	BX	50
CDR01BX472A---	4700	K,M	BX	50
<b>AVX Style 1805/CDR02</b>				
CDR02BP221B---	220	J,K	BP	100
CDR02BP271B---	270	J	BP	100
CDR02BX392B---	3900	K	BX	100
CDR02BX472B---	4700	K,M	BX	100
CDR02BX562B---	5600	K	BX	100
CDR02BX682B---	6800	K,M	BX	100
CDR02BX822B---	8200	K	BX	100
CDR02BX103B---	10,000	K,M	BX	100
CDR02BX123A---	12,000	K	BX	50
CDR02BX153A---	15,000	K,M	BX	50
CDR02BX183A---	18,000	K	BX	50
CDR02BX223A---	22,000	K,M	BX	50

- Add appropriate failure rate
- Add appropriate termination finish
- Capacitance Tolerance

Military Type Designation	Capacitance in pF	Capacitance tolerance	Rated temperature and voltage-temperature limits	WVDC
<b>AVX Style 1808/CDR03</b>				
CDR03BP331B---	330	J,K	BP	100
CDR03BP391B---	390	J	BP	100
CDR03BP471B---	470	J,K	BP	100
CDR03BP561B---	560	J	BP	100
CDR03BP681B---	680	J,K	BP	100
CDR03BP821B---	820	J	BP	100
CDR03BP102B---	1000	J,K	BP	100
CDR03BX123B---	12,000	K	BX	100
CDR03BX153B---	15,000	K,M	BX	100
CDR03BX183B---	18,000	K	BX	100
CDR03BX223B---	22,000	K,M	BX	100
CDR03BX273B---	27,000	K	BX	100
CDR03BX333B---	33,000	K,M	BX	100
CDR03BX393A---	39,000	K	BX	50
CDR03BX473A---	47,000	K,M	BX	50
CDR03BX563A---	56,000	K	BX	50
CDR03BX683A---	68,000	K,M	BX	50
<b>AVX Style 1812/CDR04</b>				
CDR04BP122B---	1200	J	BP	100
CDR04BP152B---	1500	J,K	BP	100
CDR04BP182B---	1800	J	BP	100
CDR04BP222B---	2200	J,K	BP	100
CDR04BP272B---	2700	J	BP	100
CDR04BP332B---	3300	J,K	BP	100
CDR04BX393B---	39,000	K	BX	100
CDR04BX473B---	47,000	K,M	BX	100
CDR04BX563B---	56,000	K	BX	100
CDR04BX823A---	82,000	K	BX	50
CDR04BX104A---	100,000	K,M	BX	50
CDR04BX124A---	120,000	K	BX	50
CDR04BX154A---	150,000	K,M	BX	50
CDR04BX184A---	180,000	K	BX	50
<b>AVX Style 1825/CDR05</b>				
CDR05BP392B---	3900	J,K	BP	100
CDR05BP472B---	4700	J,K	BP	100
CDR05BP562B---	5600	J,K	BP	100
CDR05BX683B---	68,000	K,M	BX	100
CDR05BX823B---	82,000	K	BX	100
CDR05BX104B---	100,000	K,M	BX	100
CDR05BX124B---	120,000	K	BX	100
CDR05BX154B---	150,000	K,M	BX	100
CDR05BX224A---	220,000	K,M	BX	50
CDR05BX274A---	270,000	K	BX	50
CDR05BX334A---	330,000	K,M	BX	50
<b>AVX Style 2225/CDR06</b>				
CDR06BP682B---	6800	J,K	BP	100
CDR06BP822B---	8200	J,K	BP	100
CDR06BP103B---	10,000	J,K	BP	100
CDR06BX394A---	390,000	K	BX	50
CDR06BX474A---	470,000	K,M	BX	50

- Add appropriate failure rate
- Add appropriate termination finish
- Capacitance Tolerance



# MIL-PRF-55681/Chips

## Military Part Number Identification

### CDR31 thru CDR35

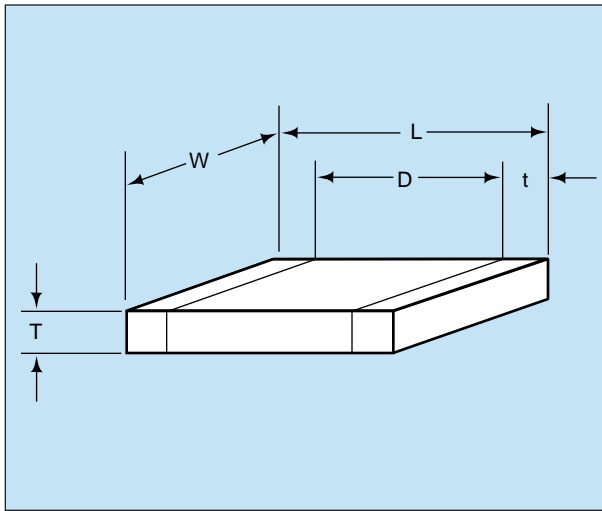

## MILITARY DESIGNATION PER MIL-PRF-55681

### Part Number Example

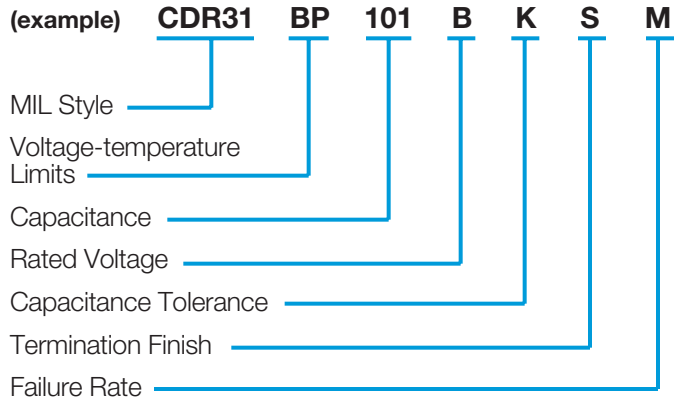

**MIL Style:** CDR31, CDR32, CDR33, CDR34, CDR35

**Voltage Temperature Limits:**

BP =  $0 \pm 30$  ppm/ $^{\circ}\text{C}$  without voltage;  $0 \pm 30$  ppm/ $^{\circ}\text{C}$  with rated voltage from  $-55^{\circ}\text{C}$  to  $+125^{\circ}\text{C}$

BX =  $\pm 15\%$  without voltage;  $+15 - 25\%$  with rated voltage from  $-55^{\circ}\text{C}$  to  $+125^{\circ}\text{C}$

**Capacitance:** Two digit figures followed by multiplier (number of zeros to be added) e.g., 101 = 100 pF

**Rated Voltage:** A = 50V, B = 100V

**Capacitance Tolerance:** C  $\pm 25\%$  pF, D  $\pm 5\%$  pF, F  $\pm 1\%$   
J  $\pm 5\%$ , K  $\pm 10\%$ , M  $\pm 20\%$

**Termination Finish:**

M = Palladium Silver  
N = Silver Nickel Gold  
S = Solder-coated

U = Base Metallization/Barrier Metal/Solder Coated\*  
W = Base Metallization/Barrier Metal/Tinned (Tin or Tin/Lead Alloy)

\*Solder shall have a melting point of  $200^{\circ}\text{C}$  or less.

**Failure Rate Level:** M = 1.0%, P = .1%, R = .01%, S = .001%

**Packaging:** Bulk is standard packaging. Tape and reel per RS481 is available upon request.

## CROSS REFERENCE: AVX/MIL-PRF-55681/CDR31 THRU CDR35

Per MIL-PRF-55681 (Metric Sizes)	AVX Style	Length (L) (mm)	Width (W) (mm)	Thickness (T)	D	Termination Band (t)	
				Max. (mm)	Min. (mm)	Max. (mm)	Min. (mm)
CDR31	0805	2.00	1.25	1.3	.50	.70	.30
CDR32	1206	3.20	1.60	1.3	—	.70	.30
CDR33	1210	3.20	2.50	1.5	—	.70	.30
CDR34	1812	4.50	3.20	1.5	—	.70	.30
CDR35	1825	4.50	6.40	1.5	—	.70	.30

# MIL-PRF-55681/Chips



## Military Part Number Identification CDR31

### CDR31 to MIL-PRF-55681/7

Military Type Designation 1/	Capacitance in pF	Capacitance tolerance	Rated temperature and voltage-temperature limits	WVDC
<b>AVX Style 0805/CDR31 (BP)</b>				
CDR31BP1R0B---	1.0	C	BP	100
CDR31BP1R1B---	1.1	C	BP	100
CDR31BP1R2B---	1.2	C	BP	100
CDR31BP1R3B---	1.3	C	BP	100
CDR31BP1R5B---	1.5	C	BP	100
CDR31BP1R6B---	1.6	C	BP	100
CDR31BP1R8B---	1.8	C	BP	100
CDR31BP2R0B---	2.0	C	BP	100
CDR31BP2R2B---	2.2	C	BP	100
CDR31BP2R4B---	2.4	C	BP	100
CDR31BP2R7B---	2.7	C,D	BP	100
CDR31BP3R0B---	3.0	C,D	BP	100
CDR31BP3R3B---	3.3	C,D	BP	100
CDR31BP3R6B---	3.6	C,D	BP	100
CDR31BP3R9B---	3.9	C,D	BP	100
CDR31BP4R3B---	4.3	C,D	BP	100
CDR31BP4R7B---	4.7	C,D	BP	100
CDR31BP5R1B---	5.1	C,D	BP	100
CDR31BP5R6B---	5.6	C,D	BP	100
CDR31BP6R2B---	6.2	C,D	BP	100
CDR31BP6R8B---	6.8	C,D	BP	100
CDR31BP7R5B---	7.5	C,D	BP	100
CDR31BP8R2B---	8.2	C,D	BP	100
CDR31BP9R1B---	9.1	C,D	BP	100
CDR31BP100B---	10	J,K	BP	100
CDR31BP110B---	11	J,K	BP	100
CDR31BP120B---	12	J,K	BP	100
CDR31BP130B---	13	J,K	BP	100
CDR31BP150B---	15	J,K	BP	100
CDR31BP160B---	16	J,K	BP	100
CDR31BP180B---	18	J,K	BP	100
CDR31BP200B---	20	J,K	BP	100
CDR31BP220B---	22	J,K	BP	100
CDR31BP240B---	24	J,K	BP	100
CDR31BP270B---	27	F,J,K	BP	100
CDR31BP300B---	30	F,J,K	BP	100
CDR31BP330B---	33	F,J,K	BP	100
CDR31BP360B---	36	F,J,K	BP	100
CDR31BP390B---	39	F,J,K	BP	100
CDR31BP430B---	43	F,J,K	BP	100
CDR31BP470B---	47	F,J,K	BP	100
CDR31BP510B---	51	F,J,K	BP	100
CDR31BP560B---	56	F,J,K	BP	100
CDR31BP620B---	62	F,J,K	BP	100
CDR31BP680B---	68	F,J,K	BP	100
CDR31BP750B---	75	F,J,K	BP	100
CDR31BP820B---	82	F,J,K	BP	100
CDR31BP910B---	91	F,J,K	BP	100

- Add appropriate failure rate
- Add appropriate termination finish
- Capacitance Tolerance

Military Type Designation 1/	Capacitance in pF	Capacitance tolerance	Rated temperature and voltage-temperature limits	WVDC
<b>AVX Style 0805/CDR31 (BP) cont'd</b>				
CDR31BP101B---	100	F,J,K	BP	100
CDR31BP111B---	110	F,J,K	BP	100
CDR31BP121B---	120	F,J,K	BP	100
CDR31BP131B---	130	F,J,K	BP	100
CDR31BP151B---	150	F,J,K	BP	100
CDR31BP161B---	160	F,J,K	BP	100
CDR31BP181B---	180	F,J,K	BP	100
CDR31BP201B---	200	F,J,K	BP	100
CDR31BP221B---	220	F,J,K	BP	100
CDR31BP241B---	240	F,J,K	BP	100
CDR31BP271B---	270	F,J,K	BP	100
CDR31BP301B---	300	F,J,K	BP	100
CDR31BP331B---	330	F,J,K	BP	100
CDR31BP361B---	360	F,J,K	BP	100
CDR31BP391B---	390	F,J,K	BP	100
CDR31BP431B---	430	F,J,K	BP	100
CDR31BP471B---	470	F,J,K	BP	100
CDR31BP511A---	510	F,J,K	BP	50
CDR31BP561A---	560	F,J,K	BP	50
CDR31BP621A---	620	F,J,K	BP	50
CDR31BP681A---	680	F,J,K	BP	50
<b>AVX Style 0805/CDR31 (BX)</b>				
CDR31BX471B---	470	K,M	BX	100
CDR31BX561B---	560	K,M	BX	100
CDR31BX681B---	680	K,M	BX	100
CDR31BX821B---	820	K,M	BX	100
CDR31BX102B---	1,000	K,M	BX	100
CDR31BX122B---	1,200	K,M	BX	100
CDR31BX152B---	1,500	K,M	BX	100
CDR31BX182B---	1,800	K,M	BX	100
CDR31BX222B---	2,200	K,M	BX	100
CDR31BX272B---	2,700	K,M	BX	100
CDR31BX332B---	3,300	K,M	BX	100
CDR31BX392B---	3,900	K,M	BX	100
CDR31BX472B---	4,700	K,M	BX	100
CDR31BX562A---	5,600	K,M	BX	50
CDR31BX682A---	6,800	K,M	BX	50
CDR31BX822A---	8,200	K,M	BX	50
CDR31BX103A---	10,000	K,M	BX	50
CDR31BX123A---	12,000	K,M	BX	50
CDR31BX153A---	15,000	K,M	BX	50
CDR31BX183A---	18,000	K,M	BX	50

- Add appropriate failure rate
- Add appropriate termination finish
- Capacitance Tolerance

1/ The complete part number will include additional symbols to indicate capacitance tolerance, termination and failure rate level.



# MIL-PRF-55681/Chips



## Military Part Number Identification CDR32

### CDR32 to MIL-PRF-55681/8

Military Type Designation 1/	Capacitance in pF	Capacitance tolerance	Rated temperature and voltage-temperature limits	WVDC
<b>AVX Style 1206/CDR32 (BP)</b>				
CDR32BP1R0B---	1.0	C	BP	100
CDR32BP1R1B---	1.1	C	BP	100
CDR32BP1R2B---	1.2	C	BP	100
CDR32BP1R3B---	1.3	C	BP	100
CDR32BP1R5B---	1.5	C	BP	100
CDR32BP1R6B---	1.6	C	BP	100
CDR32BP1R8B---	1.8	C	BP	100
CDR32BP2R0B---	2.0	C	BP	100
CDR32BP2R2B---	2.2	C	BP	100
CDR32BP2R4B---	2.4	C	BP	100
CDR32BP2R7B---	2.7	C,D	BP	100
CDR32BP3R0B---	3.0	C,D	BP	100
CDR32BP3R3B---	3.3	C,D	BP	100
CDR32BP3R6B---	3.6	C,D	BP	100
CDR32BP3R9B---	3.9	C,D	BP	100
CDR32BP4R3B---	4.3	C,D	BP	100
CDR32BP4R7B---	4.7	C,D	BP	100
CDR32BP5R1B---	5.1	C,D	BP	100
CDR32BP5R6B---	5.6	C,D	BP	100
CDR32BP6R2B---	6.2	C,D	BP	100
CDR32BP6R8B---	6.8	C,D	BP	100
CDR32BP7R5B---	7.5	C,D	BP	100
CDR32BP8R2B---	8.2	C,D	BP	100
CDR32BP9R1B---	9.1	C,D	BP	100
CDR32BP100B---	10	J,K	BP	100
CDR32BP110B---	11	J,K	BP	100
CDR32BP120B---	12	J,K	BP	100
CDR32BP130B---	13	J,K	BP	100
CDR32BP150B---	15	J,K	BP	100
CDR32BP160B---	16	J,K	BP	100
CDR32BP180B---	18	J,K	BP	100
CDR32BP200B---	20	J,K	BP	100
CDR32BP220B---	22	J,K	BP	100
CDR32BP240B---	24	J,K	BP	100
CDR32BP270B---	27	F,J,K	BP	100
CDR32BP300B---	30	F,J,K	BP	100
CDR32BP330B---	33	F,J,K	BP	100
CDR32BP360B---	36	F,J,K	BP	100
CDR32BP390B---	39	F,J,K	BP	100
CDR32BP430B---	43	F,J,K	BP	100
CDR32BP470B---	47	F,J,K	BP	100
CDR32BP510B---	51	F,J,K	BP	100
CDR32BP560B---	56	F,J,K	BP	100
CDR32BP620B---	62	F,J,K	BP	100
CDR32BP680B---	68	F,J,K	BP	100
CDR32BP750B---	75	F,J,K	BP	100
CDR32BP820B---	82	F,J,K	BP	100
CDR32BP910B---	91	F,J,K	BP	100

- Add appropriate failure rate
- Add appropriate termination finish
- Capacitance Tolerance

Military Type Designation 1/	Capacitance in pF	Capacitance tolerance	Rated temperature and voltage-temperature limits	WVDC
<b>AVX Style 1206/CDR32 (BP) cont'd</b>				
CDR32BP101B---	100	F,J,K	BP	100
CDR32BP111B---	110	F,J,K	BP	100
CDR32BP121B---	120	F,J,K	BP	100
CDR32BP131B---	130	F,J,K	BP	100
CDR32BP151B---	150	F,J,K	BP	100
CDR32BP161B---	160	F,J,K	BP	100
CDR32BP181B---	180	F,J,K	BP	100
CDR32BP201B---	200	F,J,K	BP	100
CDR32BP221B---	220	F,J,K	BP	100
CDR32BP241B---	240	F,J,K	BP	100
CDR32BP271B---	270	F,J,K	BP	100
CDR32BP301B---	300	F,J,K	BP	100
CDR32BP331B---	330	F,J,K	BP	100
CDR32BP361B---	360	F,J,K	BP	100
CDR32BP391B---	390	F,J,K	BP	100
CDR32BP431B---	430	F,J,K	BP	100
CDR32BP471B---	470	F,J,K	BP	100
CDR32BP511B---	510	F,J,K	BP	100
CDR32BP561B---	560	F,J,K	BP	100
CDR32BP621B---	620	F,J,K	BP	100
CDR32BP681B---	680	F,J,K	BP	100
CDR32BP751B---	750	F,J,K	BP	100
CDR32BP821B---	820	F,J,K	BP	100
CDR32BP911B---	910	F,J,K	BP	100
CDR32BP102B---	1,000	F,J,K	BP	100
CDR32BP112A---	1,100	F,J,K	BP	50
CDR32BP122A---	1,200	F,J,K	BP	50
CDR32BP132A---	1,300	F,J,K	BP	50
CDR32BP152A---	1,500	F,J,K	BP	50
CDR32BP162A---	1,600	F,J,K	BP	50
CDR32BP182A---	1,800	F,J,K	BP	50
CDR32BP202A---	2,000	F,J,K	BP	50
CDR32BP222A---	2,200	F,J,K	BP	50
<b>AVX Style 1206/CDR32 (BX)</b>				
CDR32BX472B---	4,700	K,M	BX	100
CDR32BX562B---	5,600	K,M	BX	100
CDR32BX682B---	6,800	K,M	BX	100
CDR32BX822B---	8,200	K,M	BX	100
CDR32BX103B---	10,000	K,M	BX	100
CDR32BX123B---	12,000	K,M	BX	100
CDR32BX153B---	15,000	K,M	BX	100
CDR32BX183A---	18,000	K,M	BX	50
CDR32BX223A---	22,000	K,M	BX	50
CDR32BX273A---	27,000	K,M	BX	50
CDR32BX333A---	33,000	K,M	BX	50
CDR32BX393A---	39,000	K,M	BX	50

- Add appropriate failure rate
- Add appropriate termination finish
- Capacitance Tolerance

1/ The complete part number will include additional symbols to indicate capacitance tolerance, termination and failure rate level.

### CDR33/34/35 to MIL-PRF-55681/9/10/11

Military Type Designation 1/	Capacitance in pF	Capacitance tolerance	Rated temperature and voltage-temperature limits	WVDC
<b>AVX Style 1210/CDR33 (BP)</b>				
CDR33BP102B---	1,000	F,J,K	BP	100
CDR33BP112B---	1,100	F,J,K	BP	100
CDR33BP122B---	1,200	F,J,K	BP	100
CDR33BP132B---	1,300	F,J,K	BP	100
CDR33BP152B---	1,500	F,J,K	BP	100
CDR33BP162B---	1,600	F,J,K	BP	100
CDR33BP182B---	1,800	F,J,K	BP	100
CDR33BP202B---	2,000	F,J,K	BP	100
CDR33BP222B---	2,200	F,J,K	BP	100
CDR33BP242A---	2,400	F,J,K	BP	50
CDR33BP272A---	2,700	F,J,K	BP	50
CDR33BP302A---	3,000	F,J,K	BP	50
CDR33BP332A---	3,300	F,J,K	BP	50
<b>AVX Style 1210/CDR33 (BX)</b>				
CDR33BX153B---	15,000	K,M	BX	100
CDR33BX183B---	18,000	K,M	BX	100
CDR33BX223B---	22,000	K,M	BX	100
CDR33BX273B---	27,000	K,M	BX	100
CDR33BX393A---	39,000	K,M	BX	50
CDR33BX473A---	47,000	K,M	BX	50
CDR33BX563A---	56,000	K,M	BX	50
CDR33BX683A---	68,000	K,M	BX	50
CDR33BX823A---	82,000	K,M	BX	50
CDR33BX104A---	100,000	K,M	BX	50
<b>AVX Style 1812/CDR34 (BP)</b>				
CDR34BP222B---	2,200	F,J,K	BP	100
CDR34BP242B---	2,400	F,J,K	BP	100
CDR34BP272B---	2,700	F,J,K	BP	100
CDR34BP302B---	3,000	F,J,K	BP	100
CDR34BP332B---	3,300	F,J,K	BP	100
CDR34BP362B---	3,600	F,J,K	BP	100
CDR34BP392B---	3,900	F,J,K	BP	100
CDR34BP432B---	4,300	F,J,K	BP	100
CDR34BP472B---	4,700	F,J,K	BP	100
CDR34BP512A---	5,100	F,J,K	BP	50
CDR34BP562A---	5,600	F,J,K	BP	50
CDR34BP622A---	6,200	F,J,K	BP	50
CDR34BP682A---	6,800	F,J,K	BP	50
CDR34BP752A---	7,500	F,J,K	BP	50
CDR34BP822A---	8,200	F,J,K	BP	50
CDR34BP912A---	9,100	F,J,K	BP	50
CDR34BP103A---	10,000	F,J,K	BP	50

- Add appropriate failure rate
- Add appropriate termination finish
- Capacitance Tolerance

Military Type Designation 1/	Capacitance in pF	Capacitance tolerance	Rated temperature and voltage-temperature limits	WVDC
<b>AVX Style 1812/CDR34 (BX)</b>				
CDR34BX273B---	27,000	K,M	BX	100
CDR34BX333B---	33,000	K,M	BX	100
CDR34BX393B---	39,000	K,M	BX	100
CDR34BX473B---	47,000	K,M	BX	100
CDR34BX563B---	56,000	K,M	BX	100
CDR34BX104A---	100,000	K,M	BX	50
CDR34BX124A---	120,000	K,M	BX	50
CDR34BX154A---	150,000	K,M	BX	50
CDR34BX184A---	180,000	K,M	BX	50
<b>AVX Style 1825/CDR35 (BP)</b>				
CDR35BP472B---	4,700	F,J,K	BP	100
CDR35BP512B---	5,100	F,J,K	BP	100
CDR35BP562B---	5,600	F,J,K	BP	100
CDR35BP622B---	6,200	F,J,K	BP	100
CDR35BP682B---	6,800	F,J,K	BP	100
CDR35BP752B---	7,500	F,J,K	BP	100
CDR35BP822B---	8,200	F,J,K	BP	100
CDR35BP912B---	9,100	F,J,K	BP	100
CDR35BP103B---	10,000	F,J,K	BP	100
CDR35BP113A---	11,000	F,J,K	BP	50
CDR35BP123A---	12,000	F,J,K	BP	50
CDR35BP133A---	13,000	F,J,K	BP	50
CDR35BP153A---	15,000	F,J,K	BP	50
CDR35BP163A---	16,000	F,J,K	BP	50
CDR35BP183A---	18,000	F,J,K	BP	50
CDR35BP203A---	20,000	F,J,K	BP	50
CDR35BP223A---	22,000	F,J,K	BP	50
<b>AVX Style 1825/CDR35 (BX)</b>				
CDR35BX563B---	56,000	K,M	BX	100
CDR35BX683B---	68,000	K,M	BX	100
CDR35BX823B---	82,000	K,M	BX	100
CDR35BX104B---	100,000	K,M	BX	100
CDR35BX124B---	120,000	K,M	BX	100
CDR35BX154B---	150,000	K,M	BX	100
CDR35BX184A---	180,000	K,M	BX	50
CDR35BX224A---	220,000	K,M	BX	50
CDR35BX274A---	270,000	K,M	BX	50
CDR35BX334A---	330,000	K,M	BX	50
CDR35BX394A---	390,000	K,M	BX	50
CDR35BX474A---	470,000	K,M	BX	50

- Add appropriate failure rate
- Add appropriate termination finish
- Capacitance Tolerance

1/ The complete part number will include additional symbols to indicate capacitance tolerance, termination and failure rate level.

# European Detail Specifications CECC 32 101-801/Chips



## Standard European Ceramic Chip Capacitors

### PART NUMBER (example)

**0805**



**Size**  
(L" x W")

**5**



**Voltage**  
50V = 5  
100V = 1  
200V = 2

**C**



**Dielectric**  
1B CG = A  
2R1 = C  
2F4 = G

**103**



**Capacitance Code**

**M**



**Capacitance Tolerance**  
See Dielectrics  
COG, X7R, Y5V

**T**



**Specification**  
CECC32101-801

**T**



**Terminations**  
T = Plated Ni  
and Sn

**2**



**Marking Packaging**  
2 = 7" Reel  
4 = 13" Reel

**A**



**Special Code**  
A = Std.  
Product

### RANGE OF APPROVED COMPONENTS

Case Size	Dielectric Type	Voltage and Capacitance Range		
		50V	100V	200V
<b>1BCG</b>				
0603	1B CG	0.47pF - 150pF	0.47pF - 120pF	0.47pF - 100pF
0805	1B CG	0.47pF - 560pF	0.47pF - 560pF	0.47pF - 330pF
1206	1B CG	0.47pF - 3.3nF	0.47pF - 3.3nF	0.47pF - 1.5nF
1210	1B CG	0.47pF - 4.7nF	0.47pF - 4.7nF	0.47pF - 2.7nF
1808	1B CG	0.47pF - 6.8nF	0.47pF - 6.8nF	0.47pF - 4.7nF
1812	1B CG	0.47pF - 15nF	0.47pF - 15nF	0.47pF - 10nF
2220	1B CG	0.47pF - 39nF	0.47pF - 39nF	0.47pF - 15nF
<b>2R1</b>				
0603	2R1	10pF - 6.8nF	10pF - 6.8nF	10pF - 1.2nF
0805	2R1	10pF - 33nF	10pF - 18nF	10pF - 3.3nF
1206	2R1	10pF - 100nF	10pF - 68nF	10pF - 18nF
1210	2R1	10pF - 150nF	10pF - 100nF	10pF - 27nF
1808	2R1	10pF - 270nF	10pF - 180nF	10pF - 47nF
1812	2R1	10pF - 470nF	10pF - 330nF	10pF - 100nF
2220	2R1	10pF - 1.2μF	10pF - 680nF	10pF - 220nF
<b>2F4</b>				
0805	2F4	10pF - 100nF		
1206	2F4	10pF - 330nF		
1210	2F4	10pF - 470nF		
1808	2F4	10pF - 560nF		
1812	2F4	10pF - 1.8μF		
2220	2F4	10pF - 2.2μF		



# Packaging of Chip Components



## Automatic Insertion Packaging

### TAPE & REEL QUANTITIES

All tape and reel specifications are in compliance with RS481.

	8mm	12mm	
Paper or Embossed Carrier	0805, 1005, 1206, 1210		
Embossed Only	0504, 0907	1505, 1805, 1808	1812, 1825, 2220, 2225
Paper Only	0402, 0603		
Qty. per Reel/7" Reel	2,000 or 4,000 <sup>(1)</sup>	3,000	1,000
Qty. per Reel/13" Reel	10,000	10,000	4,000

<sup>(1)</sup> Dependent on chip thickness. Low profile chips shown on page 27 are 5,000 per reel for 7" reel. 0402 size chips are 10,000 per 7" reels and are not available on 13" reels. For 3640 size chip contact factory for quantity per reel.

### REEL DIMENSIONS

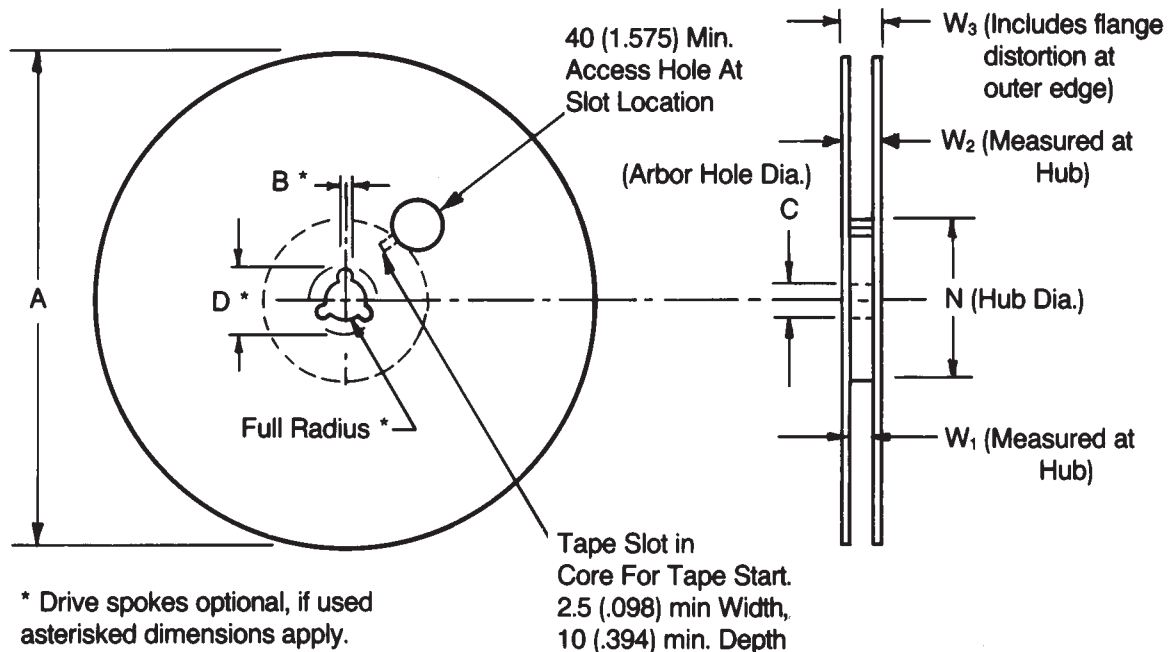

Tape Size <sup>(1)</sup>	A Max.	B* Min.	C	D* Min.	N Min.	W <sub>1</sub>	W <sub>2</sub> Max.	W <sub>3</sub>
8mm	330 (12.992)	1.5 (.059)	13.0±0.20 (.512±.008)	20.2 (.795)	50 (1.969)	8.4 <sup>+1.0</sup> <sub>-0.0</sub> (.331 <sup>+0.60</sup> <sub>-0.0</sub> )	14.4 (.567)	7.9 Min. (.311)
12mm						12.4 <sup>+2.0</sup> <sub>-0.0</sub> (.488 <sup>+0.76</sup> <sub>-0.0</sub> )		11.9 Min. (.469)

Metric dimensions will govern.

English measurements rounded and for reference only.

<sup>(1)</sup> For tape sizes 16mm and 24mm (used with chip size 3640) consult EIA RS-481 latest revision.

# Embossed Carrier Configuration



## 8 & 12mm Tape Only

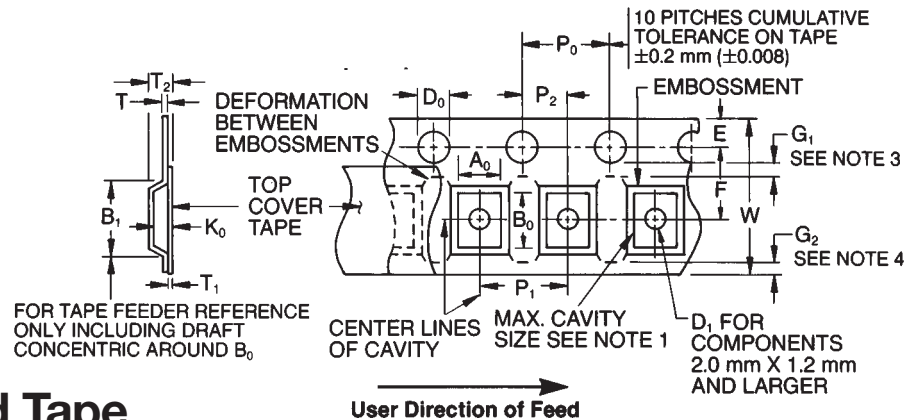

## 8 & 12mm Embossed Tape Metric Dimensions Will Govern

### CONSTANT DIMENSIONS

Tape Size	D <sub>0</sub>	E	P <sub>0</sub>	P <sub>2</sub>	T Max.	T <sub>1</sub>	G <sub>1</sub>	G <sub>2</sub>
8mm and 12mm	8.4 <sup>+0.10</sup> <sub>-0.0</sub> (.059 <sup>+0.004</sup> <sub>-0.0</sub> )	1.75 ± 0.10 (.069 ± .004)	4.0 ± 0.10 (.157 ± .004)	2.0 ± 0.05 (.079 ± .002)	0.600 (.024)	0.10 (.004) Max.	0.75 (.030) Min. See Note 3	0.75 (.030) Min. See Note 4

### VARIABLE DIMENSIONS

Tape Size	B <sub>1</sub> Max. See Note 6	D <sub>1</sub> Min. See Note 5	F	P <sub>1</sub>	R Min. See Note 2	T <sub>2</sub>	W	A <sub>0</sub> B <sub>0</sub> K <sub>0</sub>
8mm	4.55 (.179)	1.0 (.039)	3.5 ± 0.05 (.138 ± .002)	4.0 ± 0.10 (.157 ± .004)	25 (.984)	2.5 Max. (.098)	8.0 <sup>+0.3</sup> <sub>-0.1</sub> (.315 <sup>+0.012</sup> <sub>-0.004</sub> )	See Note 1
12mm	8.2 (.323)	1.5 (.059)	5.5 ± 0.05 (.217 ± .002)	4.0 ± 0.10 (.157 ± .004)	30 (1.181)	6.5 Max. (.256)	12.0 ± .30 (.472 ± .012)	See Note 1
8mm 1/2 Pitch	4.55 (.179)	1.0 (.039)	3.5 ± 0.05 (.138 ± .002)	2.0 ± 0.10 0.79 ± .004	25 (.984)	2.5 Max. (.098)	8.0 <sup>+0.3</sup> <sub>-0.1</sub> (.315 <sup>+0.012</sup> <sub>-0.004</sub> )	See Note 1
12mm Double Pitch	8.2 (.323)	1.5 (.059)	5.5 ± 0.05 (.217 ± .002)	8.0 ± 0.10 (.315 ± .004)	30 (1.181)	6.5 Max. (.256)	12.0 ± .30 (.472 ± .012)	See Note 1

#### NOTES:

- A<sub>0</sub>, B<sub>0</sub>, and K<sub>0</sub> are determined by the max. dimensions to the ends of the terminals extending from the component body and/or the body dimensions of the component. The clearance between the end of the terminals or body of the component to the sides and depth of the cavity (A<sub>0</sub>, B<sub>0</sub>, and K<sub>0</sub>) must be within 0.05 mm (.002) min. and 0.50 mm (.020) max. The clearance allowed must also prevent rotation of the component within the cavity of not more than 20 degrees (see sketches C & D).
- Tape with components shall pass around radius "R" without damage. The minimum trailer length (Note 2 Fig. 3) may require additional length to provide R min. for 12 mm embossed tape for reels with hub diameters approaching N min. (Table 4).
- G<sub>1</sub> dimension is the flat area from the edge of the sprocket hole to either the outward deformation of the carrier tape between the embossed cavities or to the edge of the cavity whichever is less.
- G<sub>2</sub> dimension is the flat area from the edge of the carrier tape opposite the sprocket holes to either the outward deformation of the carrier tape between the embossed cavity or to the edge of the cavity whichever is less.
- The embossment hole location shall be measured from the sprocket hole controlling the location of the embossment. Dimensions of embossment location and hole location shall be applied independent of each other.
- B<sub>1</sub> dimension is a reference dimension for tape feeder clearance only.

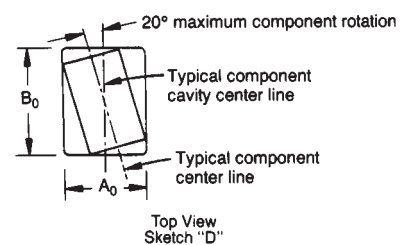
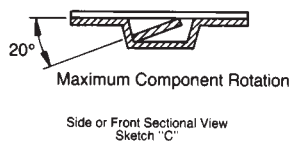

# Paper Carrier Configuration



## 8 & 12mm Tape Only

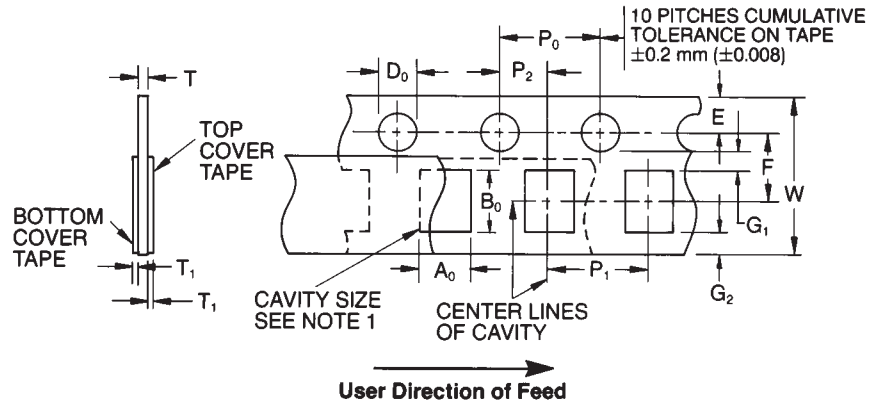

## 8 & 12mm Paper Tape Metric Dimensions Will Govern

### CONSTANT DIMENSIONS

Tape Size	D <sub>0</sub>	E	P <sub>0</sub>	P <sub>2</sub>	T <sub>1</sub>	G <sub>1</sub>	G <sub>2</sub>	R MIN.
8mm and 12mm	1.5 <sup>+0.1</sup> <sub>-0.0</sub> (.059 <sup>+0.004</sup> <sub>-.000</sub> )	1.75 ± 0.10 (.069 ± .004)	4.0 ± 0.10 (.157 ± .004)	2.0 ± 0.05 (.079 ± .002)	0.10 (.004) Max.	0.75 (.030) Min.	0.75 (.030) Min.	25 (.984) See Note 2

### VARIABLE DIMENSIONS

Tape Size	P <sub>1</sub>	F	W	A <sub>0</sub> B <sub>0</sub>	T
8mm	4.0 ± 0.10 (.157 ± .004)	3.5 ± 0.05 (.138 ± .002)	8.0 <sup>+0.3</sup> <sub>-0.1</sub> (.315 <sup>+0.012</sup> <sub>-.004</sub> )	See Note 1	See Note 3
12mm	4.0 ± .010 (.157 ± .004)	5.5 ± 0.05 (.217 ± .002)	12.0 ± 0.3 (.472 ± .012)		
8mm 1/2 Pitch	2.0 ± 0.10 (.079 ± .004)	3.5 ± 0.05 (.138 ± .002)	8.0 <sup>+0.3</sup> <sub>-0.1</sub> (.315 <sup>+0.012</sup> <sub>-.004</sub> )		
12mm Double Pitch	8.0 ± 0.10 (.315 ± .004)	5.5 ± 0.05 (.217 ± .002)	12.0 ± 0.3 (.472 ± .012)		

#### NOTES:

- A<sub>0</sub>, B<sub>0</sub>, and T are determined by the max. dimensions to the ends of the terminals extending from the component body and/or the body dimensions of the component. The clearance between the ends of the terminals or body of the component to the sides and depth of the cavity (A<sub>0</sub>, B<sub>0</sub>, and T) must be within 0.05 mm (.002) min. and 0.50 mm (.020) max. The clearance allowed must also prevent rotation of the component within the cavity of not more than 20 degrees (see sketches A & B).
- Tape with components shall pass around radius "R" without damage.
- 1.1 mm (.043) Base Tape and 1.6 mm (.063) Max. for Non-Paper Base Compositions.

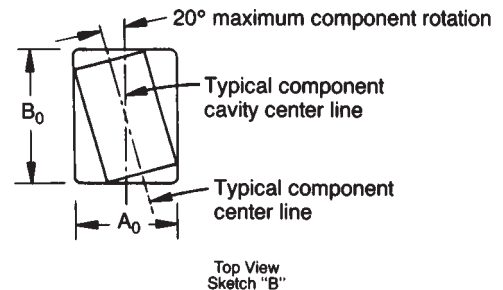
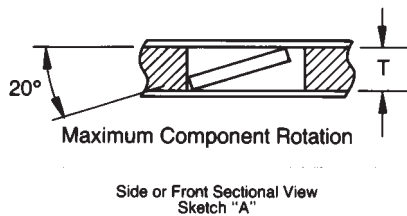

## Bar Code Labeling Standard

AVX bar code labeling is available and follows latest version of EIA-556-A.

## BENEFITS

- Easier handling
- Smaller packaging volume  
(1/20 of T/R packaging)
- Easier inventory control
- Flexibility
- Recyclable

## CASE DIMENSIONS

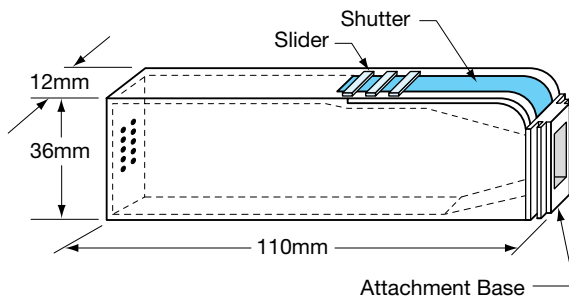

## BULK FEEDER

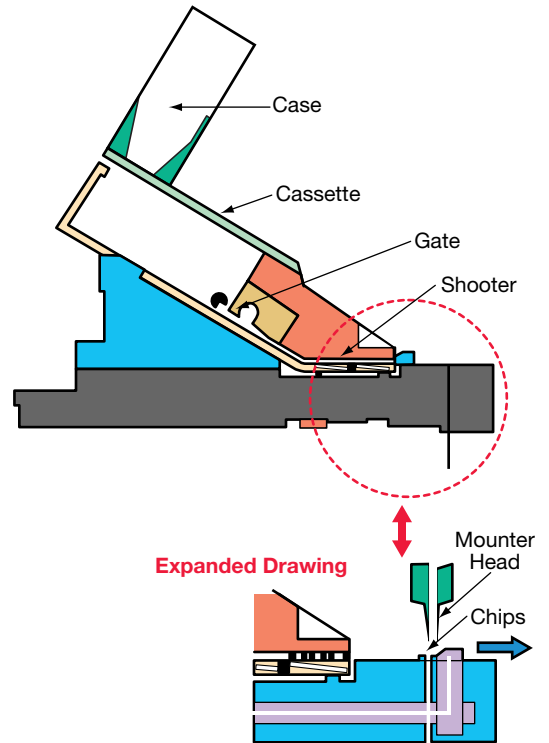

## CASE QUANTITIES

Part Size	0402	0603	0805
Qty. (pcs / cassette)	80,000	15,000	10,000 (T=0.6mm) 5,000 (T≥0.6mm)

**Basic Construction** – A multilayer ceramic (MLC) capacitor is a monolithic block of ceramic containing two sets of offset, interleaved planar electrodes that extend to two opposite surfaces of the ceramic dielectric. This simple

structure requires a considerable amount of sophistication, both in material and manufacture, to produce it in the quality and quantities needed in today's electronic equipment.

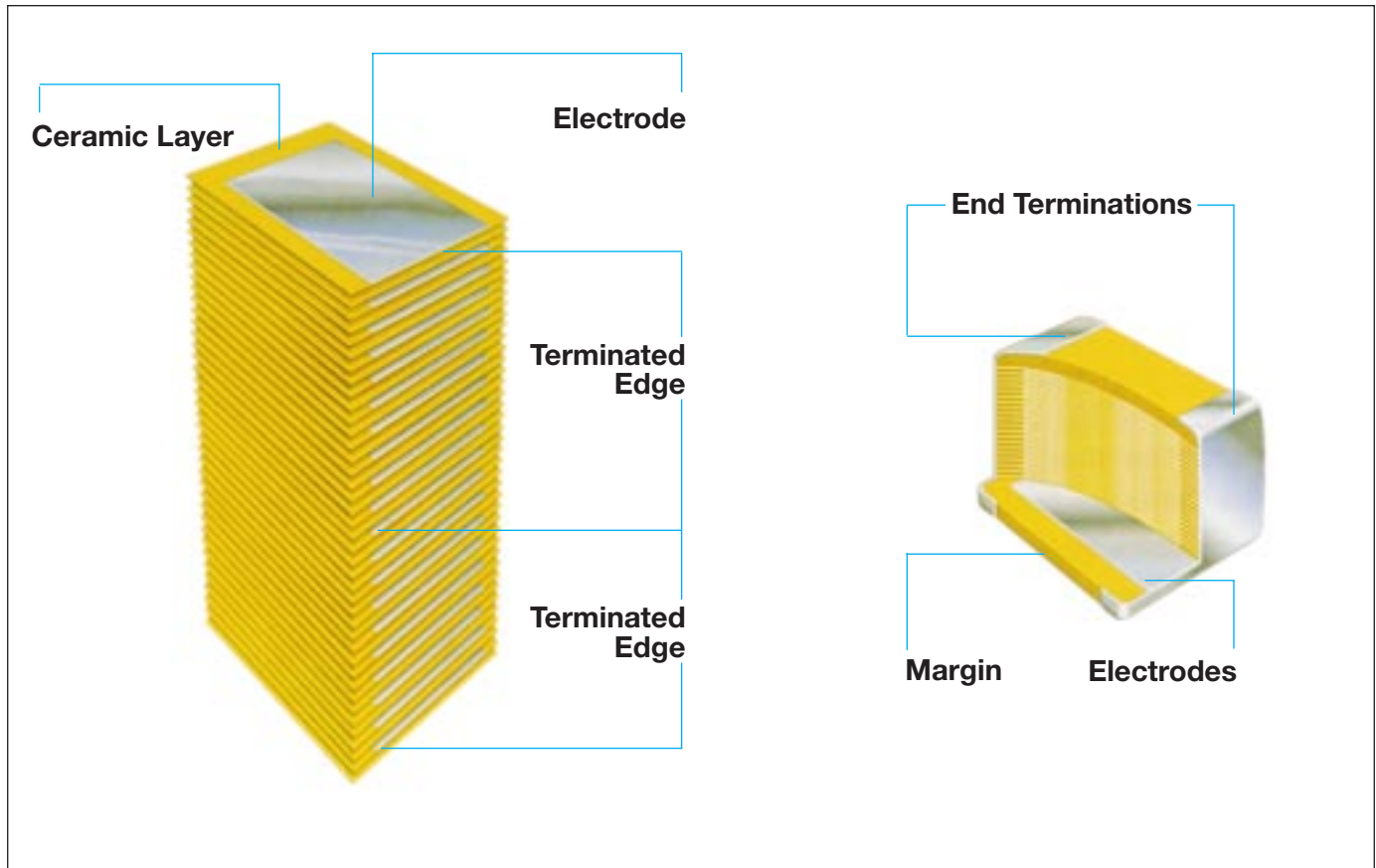

**Formulations** – Multilayer ceramic capacitors are available in both Class 1 and Class 2 formulations. Temperature compensating formulations are Class 1 and temperature stable and general application formulations are classified as Class 2.

**Class 1** – Class 1 capacitors or temperature compensating capacitors are usually made from mixtures of titanates where barium titanate is normally not a major part of the mix. They have predictable temperature coefficients and in general, do not have an aging characteristic. Thus they are the most stable capacitor available. The most popular Class 1 multilayer ceramic capacitors are C0G (NP0) temperature compensating capacitors (negative-positive 0 ppm/°C).

**Class 2** – EIA Class 2 capacitors typically are based on the chemistry of barium titanate and provide a wide range of capacitance values and temperature stability. The most commonly used Class 2 dielectrics are X7R and Y5V. The X7R provides intermediate capacitance values which vary only  $\pm 15\%$  over the temperature range of  $-55^{\circ}\text{C}$  to  $125^{\circ}\text{C}$ . It finds applications where stability over a wide temperature range is required.

The Y5V provides the highest capacitance values and is used in applications where limited temperature changes are expected. The capacitance value for Y5V can vary from 22% to -82% over the  $-30^{\circ}\text{C}$  to  $85^{\circ}\text{C}$  temperature range. The Z5U dielectric is between X7R and Y5V in both stability and capacitance range.

All Class 2 capacitors vary in capacitance value under the influence of temperature, operating voltage (both AC and DC), and frequency. For additional information on performance changes with operating conditions, consult AVX's software, SpiCap.

**Effects of Voltage** – Variations in voltage have little effect on Class 1 dielectric but does affect the capacitance and dissipation factor of Class 2 dielectrics. The application of DC voltage reduces both the capacitance and dissipation factor while the application of an AC voltage within a reasonable range tends to increase both capacitance and dissipation factor readings. If a high enough AC voltage is applied, eventually it will reduce capacitance just as a DC voltage will. Figure 2 shows the effects of AC voltage.

**Cap. Change vs. A.C. Volts  
AVX X7R T.C.**

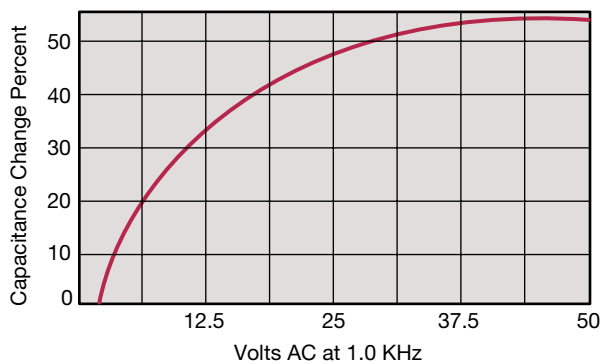

Figure 2

Capacitor specifications specify the AC voltage at which to measure (normally 0.5 or 1 VAC) and application of the wrong voltage can cause spurious readings. Figure 3 gives the voltage coefficient of dissipation factor for various AC voltages at 1 kilohertz. Applications of different frequencies will affect the percentage changes versus voltages.

**D.F. vs. A.C. Measurement Volts  
AVX X7R T.C.**

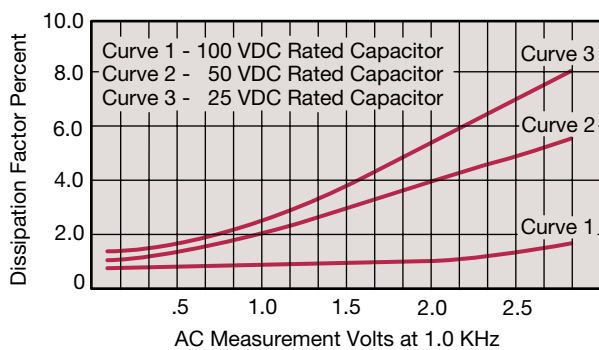

Figure 3

The effect of the application of DC voltage is shown in Figure 4. The voltage coefficient is more pronounced for higher K dielectrics. These figures are shown for room temperature conditions. The combination characteristic known as voltage temperature limits which shows the effects of rated voltage over the operating temperature range is shown in Figure 5 for the military BX characteristic.

**Cap. Change vs. D.C. Volts  
AVX X7R T.C.**

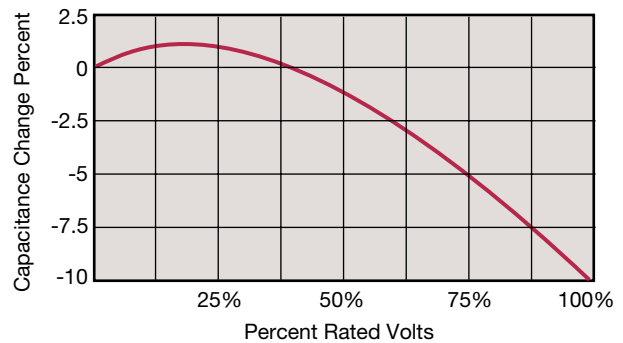

Figure 4

**Typical Cap. Change vs. Temperature  
AVX X7R T.C.**

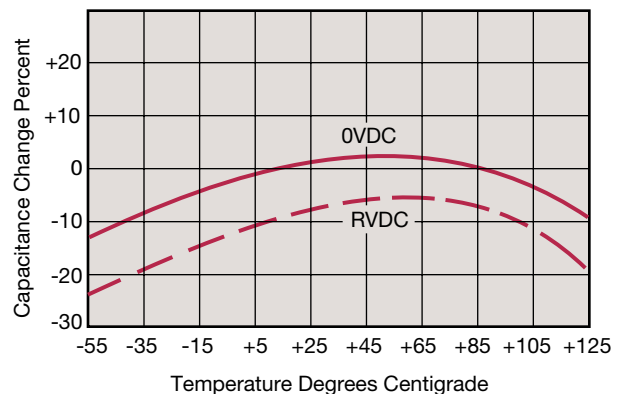

Figure 5

**Effects of Time** – Class 2 ceramic capacitors change capacitance and dissipation factor with time as well as temperature, voltage and frequency. This change with time is known as aging. Aging is caused by a gradual re-alignment of the crystalline structure of the ceramic and produces an exponential loss in capacitance and decrease in dissipation factor versus time. A typical curve of aging rate for semi-stable ceramics is shown in Figure 6.

If a Class 2 ceramic capacitor that has been sitting on the shelf for a period of time, is heated above its curie point, (125°C for 4 hours or 150°C for ½ hour will suffice) the part will de-age and return to its initial capacitance and dissipation factor readings. Because the capacitance changes rapidly, immediately after de-aging, the basic capacitance measurements are normally referred to a time period sometime after the de-aging process. Various manufacturers use different time bases but the most popular one is one day or twenty-four hours after “last heat.” Change in the aging curve can be caused by the application of voltage and other stresses. The possible changes in capacitance due to de-aging by heating the unit explain why capacitance changes are allowed after test, such as temperature cycling, moisture resistance, etc., in MIL specs. The application of high voltages such as dielectric withstanding voltages also

tends to de-age capacitors and is why re-reading of capacitance after 12 or 24 hours is allowed in military specifications after dielectric strength tests have been performed.

**Typical Curve of Aging Rate  
X7R Dielectric**

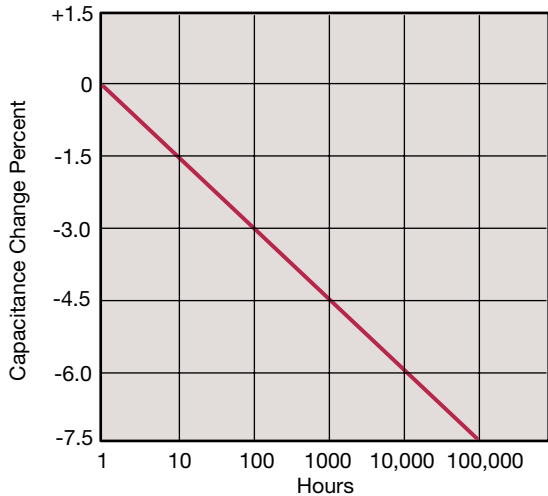

Characteristic	Max. Aging Rate %/Decade
C0G (NPO)	None
X7R	2
Z5U	3
Y5V	5

Figure 6

**Effects of Frequency** – Frequency affects capacitance and impedance characteristics of capacitors. This effect is much more pronounced in high dielectric constant ceramic formulation that is low K formulations. AVX’s SpiCap software generates impedance, ESR, series inductance, series resonant frequency and capacitance all as functions of frequency, temperature and DC bias for standard chip sizes and styles. It is available free from AVX.



**Effects of Mechanical Stress** – High “K” dielectric ceramic capacitors exhibit some low level piezoelectric reactions under mechanical stress. As a general statement, the piezoelectric output is higher, the higher the dielectric constant of the ceramic. It is desirable to investigate this effect before using high “K” dielectrics as coupling capacitors in extremely low level applications.

**Reliability** – Historically ceramic capacitors have been one of the most reliable types of capacitors in use today. The approximate formula for the reliability of a ceramic capacitor is:

$$\frac{L_o}{L_t} = \left(\frac{V_t}{V_o}\right)^X \left(\frac{T_t}{T_o}\right)^Y$$

where

- $L_o$  = operating life
- $L_t$  = test life
- $V_t$  = test voltage
- $V_o$  = operating voltage
- $T_t$  = test temperature and
- $T_o$  = operating temperature in °C
- $X, Y$  = see text

Historically for ceramic capacitors exponent X has been considered as 3. The exponent Y for temperature effects typically tends to run about 8.

A capacitor is a component which is capable of storing electrical energy. It consists of two conductive plates (electrodes) separated by insulating material which is called the dielectric. A typical formula for determining capacitance is:

$$C = \frac{.224 KA}{t}$$

- $C$  = capacitance (picofarads)
- $K$  = dielectric constant (Vacuum = 1)
- $A$  = area in square inches
- $t$  = separation between the plates in inches (thickness of dielectric)
- $.224$  = conversion constant (.0884 for metric system in cm)

**Capacitance** – The standard unit of capacitance is the farad. A capacitor has a capacitance of 1 farad when 1 coulomb charges it to 1 volt. One farad is a very large unit and most capacitors have values in the micro ( $10^{-6}$ ), nano ( $10^{-9}$ ) or pico ( $10^{-12}$ ) farad level.

**Dielectric Constant** – In the formula for capacitance given above the dielectric constant of a vacuum is arbitrarily chosen as the number 1. Dielectric constants of other materials are then compared to the dielectric constant of a vacuum.

**Dielectric Thickness** – Capacitance is indirectly proportional to the separation between electrodes. Lower voltage requirements mean thinner dielectrics and greater capacitance per volume.

**Area** – Capacitance is directly proportional to the area of the electrodes. Since the other variables in the equation are usually set by the performance desired, area is the easiest parameter to modify to obtain a specific capacitance within a material group.

# General Description



**Energy Stored** – The energy which can be stored in a capacitor is given by the formula:

$$E = \frac{1}{2}CV^2$$

**E** = energy in joules (watts-sec)  
**V** = applied voltage  
**C** = capacitance in farads

**Potential Change** – A capacitor is a reactive component which reacts against a change in potential across it. This is shown by the equation for the linear charge of a capacitor:

$$I_{ideal} = C \frac{dV}{dt}$$

where

**I** = Current  
**C** = Capacitance  
**dV/dt** = Slope of voltage transition across capacitor

Thus an infinite current would be required to instantly change the potential across a capacitor. The amount of current a capacitor can “sink” is determined by the above equation.

**Equivalent Circuit** – A capacitor, as a practical device, exhibits not only capacitance but also resistance and inductance. A simplified schematic for the equivalent circuit is:

**C** = Capacitance                      **L** = Inductance  
**R<sub>s</sub>** = Series Resistance              **R<sub>p</sub>** = Parallel Resistance

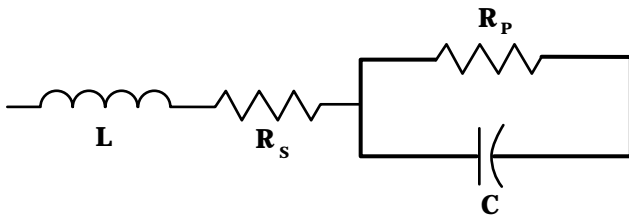

**Reactance** – Since the insulation resistance (**R<sub>p</sub>**) is normally very high, the total impedance of a capacitor is:

$$Z = \sqrt{R_s^2 + (X_c - X_L)^2}$$

where

**Z** = Total Impedance  
**R<sub>s</sub>** = Series Resistance  
**X<sub>c</sub>** = Capacitive Reactance =  $\frac{1}{2\pi fC}$   
**X<sub>L</sub>** = Inductive Reactance =  $2\pi fL$

The variation of a capacitor’s impedance with frequency determines its effectiveness in many applications.

**Phase Angle** – Power Factor and Dissipation Factor are often confused since they are both measures of the loss in a capacitor under AC application and are often almost identical in value. In a “perfect” capacitor the current in the capacitor will lead the voltage by 90°.

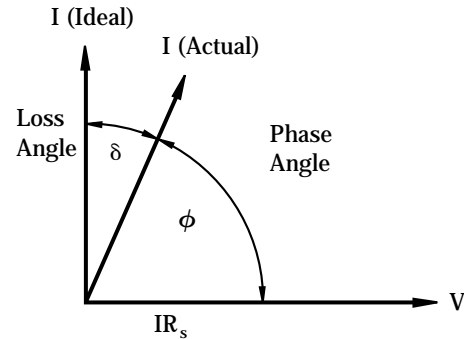

In practice the current leads the voltage by some other phase angle due to the series resistance **R<sub>s</sub>**. The complement of this angle is called the loss angle and:

Power Factor (P.F.) = Cos  $\phi$  or Sine  $\delta$   
Dissipation Factor (D.F.) = tan  $\delta$

for small values of  $\delta$  the tan and sine are essentially equal which has led to the common interchangeability of the two terms in the industry.

**Equivalent Series Resistance** – The term E.S.R. or Equivalent Series Resistance combines all losses both series and parallel in a capacitor at a given frequency so that the equivalent circuit is reduced to a simple R-C series connection.

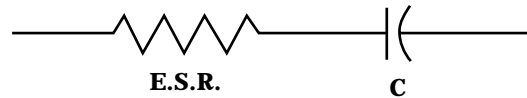

**Dissipation Factor** – The DF/PF of a capacitor tells what percent of the apparent power input will turn to heat in the capacitor.

$$\text{Dissipation Factor} = \frac{\text{E.S.R.}}{X_c} = (2\pi fC) (\text{E.S.R.})$$

The watts loss are:

$$\text{Watts loss} = (2\pi fCV^2) (\text{D.F.})$$

Very low values of dissipation factor are expressed as their reciprocal for convenience. These are called the “Q” or Quality factor of capacitors.

**Parasitic Inductance** – The parasitic inductance of capacitors is becoming more and more important in the decoupling of today’s high speed digital systems. The relationship between the inductance and the ripple voltage induced on the DC voltage line can be seen from the simple inductance equation:

$$V = L \frac{di}{dt}$$



The  $\frac{di}{dt}$  seen in current microprocessors can be as high as 0.3 A/ns, and up to 10A/ns. At 0.3 A/ns, 100pH of parasitic inductance can cause a voltage spike of 30mV. While this does not sound very drastic, with the Vcc for microprocessors decreasing at the current rate, this can be a fairly large percentage.

Another important, often overlooked, reason for knowing the parasitic inductance is the calculation of the resonant frequency. This can be important for high frequency, bypass capacitors, as the resonant point will give the most signal attenuation. The resonant frequency is calculated from the simple equation:

$$f_{res} = \frac{1}{2\pi\sqrt{LC}}$$

**Insulation Resistance** – Insulation Resistance is the resistance measured across the terminals of a capacitor and consists principally of the parallel resistance  $R_P$  shown in the equivalent circuit. As capacitance values and hence the area of dielectric increases, the I.R. decreases and hence the product (C x IR or RC) is often specified in ohm farads or more commonly megohm-microfarads. Leakage current

is determined by dividing the rated voltage by IR (Ohm's Law).

**Dielectric Strength** – Dielectric Strength is an expression of the ability of a material to withstand an electrical stress. Although dielectric strength is ordinarily expressed in volts, it is actually dependent on the thickness of the dielectric and thus is also more generically a function of volts/mil.

**Dielectric Absorption** – A capacitor does not discharge instantaneously upon application of a short circuit, but drains gradually after the capacitance proper has been discharged. It is common practice to measure the dielectric absorption by determining the “reappearing voltage” which appears across a capacitor at some point in time after it has been fully discharged under short circuit conditions.

**Corona** – Corona is the ionization of air or other vapors which causes them to conduct current. It is especially prevalent in high voltage units but can occur with low voltages as well where high voltage gradients occur. The energy discharged degrades the performance of the capacitor and can in time cause catastrophic failures.

# Surface Mounting Guide



## MLC Chip Capacitors

### Component Pad Design

Component pads should be designed to achieve good solder filets and minimize component movement during reflow soldering. Pad designs are given below for the most common sizes of multilayer ceramic capacitors for both wave and reflow soldering. The basis of these designs is:

- Pad width equal to component width. It is permissible to decrease this to as low as 85% of component width but it is not advisable to go below this.
- Pad overlap 0.5mm beneath component.
- Pad extension 0.5mm beyond components for reflow and 1.0mm for wave soldering.

### REFLOW SOLDERING

Case Size	D1	D2	D3	D4	D5
<b>0402</b>	1.70 (0.07)	0.60 (0.02)	0.50 (0.02)	0.60 (0.02)	0.50 (0.02)
<b>0603</b>	2.30 (0.09)	0.80 (0.03)	0.70 (0.03)	0.80 (0.03)	0.75 (0.03)
<b>0805</b>	3.00 (0.12)	1.00 (0.04)	1.00 (0.04)	1.00 (0.04)	1.25 (0.05)
<b>1206</b>	4.00 (0.16)	1.00 (0.04)	2.00 (0.09)	1.00 (0.04)	1.60 (0.06)
<b>1210</b>	4.00 (0.16)	1.00 (0.04)	2.00 (0.09)	1.00 (0.04)	2.50 (0.10)
<b>1808</b>	5.60 (0.22)	1.00 (0.04)	3.60 (0.14)	1.00 (0.04)	2.00 (0.08)
<b>1812</b>	5.60 (0.22)	1.00 (0.04))	3.60 (0.14)	1.00 (0.04)	3.00 (0.12)
<b>1825</b>	5.60 (0.22)	1.00 (0.04)	3.60 (0.14)	1.00 (0.04)	6.35 (0.25)
<b>2220</b>	6.60 (0.26)	1.00 (0.04)	4.60 (0.18)	1.00 (0.04)	5.00 (0.20)
<b>2225</b>	6.60 (0.26)	1.00 (0.04)	4.60 (0.18)	1.00 (0.04)	6.35 (0.25)

Dimensions in millimeters (inches)

### WAVE SOLDERING

Case Size	D1	D2	D3	D4	D5
<b>0603</b>	3.10 (0.12)	1.20 (0.05)	0.70 (0.03)	1.20 (0.05)	0.75 (0.03)
<b>0805</b>	4.00 (0.15)	1.50 (0.06)	1.00 (0.04)	1.50 (0.06)	1.25 (0.05)
<b>1206</b>	5.00 (0.19)	1.50 (0.06)	2.00 (0.09)	1.50 (0.06)	1.60 (0.06)
<b>1210</b>	5.00 (0.19)	1.50 (0.06)	2.00 (0.09)	1.50 (0.06)	2.50 (0.10)

Dimensions in millimeters (inches)

#### Component Spacing

For wave soldering components, must be spaced sufficiently far apart to avoid bridging or shadowing (inability of solder to penetrate properly into small spaces). This is less important for reflow soldering but sufficient space must be allowed to enable rework should it be required.

#### Preheat & Soldering

The rate of preheat should not exceed 4°C/second to prevent thermal shock. A better maximum figure is about 2°C/second.

For capacitors size 1206 and below, with a maximum thickness of 1.25mm, it is generally permissible to allow a temperature differential from preheat to soldering of 150°C. In all other cases this differential should not exceed 100°C.

For further specific application or process advice, please consult AVX.

#### Cleaning

Care should be taken to ensure that the capacitors are thoroughly cleaned of flux residues especially the space beneath the capacitor. Such residues may otherwise become conductive and effectively offer a low resistance bypass to the capacitor.

Ultrasonic cleaning is permissible, the recommended conditions being 8 Watts/litre at 20-45 kHz, with a process cycle of 2 minutes vapor rinse, 2 minutes immersion in the ultrasonic solvent bath and finally 2 minutes vapor rinse.

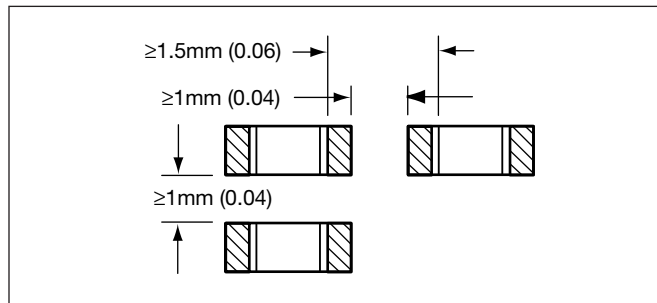

# Surface Mounting Guide



## MLC Chip Capacitors

### APPLICATION NOTES

#### Storage

Good solderability is maintained for at least twelve months, provided the components are stored in their “as received” packaging at less than 40°C and 70% RH.

#### Solderability

Terminations to be well soldered after immersion in a 60/40 tin/lead solder bath at 235 ±5°C for 2±1 seconds.

#### Leaching

Terminations will resist leaching for at least the immersion times and conditions shown below.

Termination Type	Solder Tin/Lead/Silver	Solder Temp. °C	Immersion Time Seconds
Nickel Barrier	60/40/0	260±5	30±1

### Recommended Soldering Profiles

#### Reflow

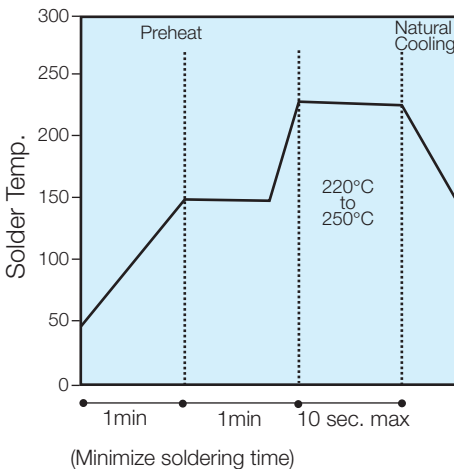

#### Wave

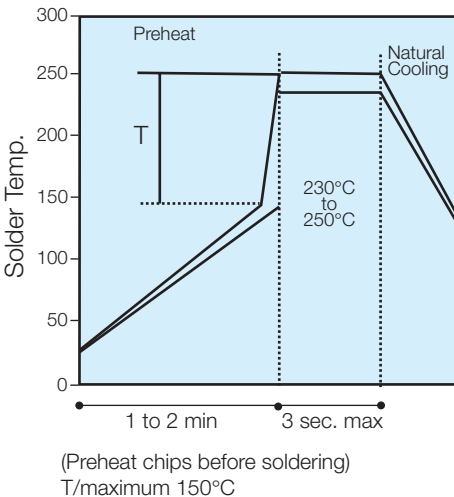

#### General

Surface mounting chip multilayer ceramic capacitors are designed for soldering to printed circuit boards or other substrates. The construction of the components is such that they will withstand the time/temperature profiles used in both wave and reflow soldering methods.

#### Handling

Chip multilayer ceramic capacitors should be handled with care to avoid damage or contamination from perspiration and skin oils. The use of tweezers or vacuum pick ups is strongly recommended for individual components. Bulk handling should ensure that abrasion and mechanical shock are minimized. Taped and reeled components provides the ideal medium for direct presentation to the placement machine. Any mechanical shock should be minimized during handling chip multilayer ceramic capacitors.

#### Preheat

It is important to avoid the possibility of thermal shock during soldering and carefully controlled preheat is therefore required. The rate of preheat should not exceed 4°C/second and a target figure 2°C/second is recommended. Although an 80°C to 120°C temperature differential is preferred, recent developments allow a temperature differential between the component surface and the soldering temperature of 150°C (Maximum) for capacitors of 1210 size and below with a maximum thickness of 1.25mm. The user is cautioned that the risk of thermal shock increases as chip size or temperature differential increases.

#### Soldering

Mildly activated rosin fluxes are preferred. The minimum amount of solder to give a good joint should be used. Excessive solder can lead to damage from the stresses caused by the difference in coefficients of expansion between solder, chip and substrate. AVX terminations are suitable for all wave and reflow soldering systems. If hand soldering cannot be avoided, the preferred technique is the utilization of hot air soldering tools.

#### Cooling

Natural cooling in air is preferred, as this minimizes stresses within the soldered joint. When forced air cooling is used, cooling rate should not exceed 4°C/second. Quenching is not recommended but if used, maximum temperature differentials should be observed according to the preheat conditions above.

#### Cleaning

Flux residues may be hygroscopic or acidic and must be removed. AVX MLC capacitors are acceptable for use with all of the solvents described in the specifications MIL-STD-202 and EIA-RS-198. Alcohol based solvents are acceptable and properly controlled water cleaning systems are also acceptable. Many other solvents have been proven successful, and most solvents that are acceptable to other components on circuit assemblies are equally acceptable for use with ceramic capacitors.

### **Internet –**

For more information visit us on the worldwide web at  
<http://www.avxcorp.com>

### **FAX Back Service –**

Just dial 1-800-879-1613 and request the index for additional catalog information faxed to your FAX number.

### **CD ROM –**

Or get in touch with your AVX representative for a CD Rom or copies of the catalogs and technical papers.

### **Software –**

Comprehensive capacitor application software library which includes:

- SpiCap (for MLC chip capacitors)
- SpiTan (for tantalum capacitors)
- SpiCalci (for power supply capacitors)
- SpiMic (for RF-Microwave capacitors)

**For AVX/Elco connector information contact your local  
AVX/Elco representative**

NOTICE: Specifications are subject to change without notice. Contact your nearest AVX Sales Office for the latest specifications. All statements, information and data given herein are believed to be accurate and reliable, but are presented without guarantee, warranty, or responsibility of any kind, expressed or implied. Statements or suggestions concerning possible use of our products are made without representation or warranty that any such use is free of patent infringement and are not recommendations to infringe any patent. The user should not assume that all safety measures are indicated or that other measures may not be required. Specifications are typical and may not apply to all applications.

## USA

### AVX Myrtle Beach, SC Corporate Offices

Tel: 843-448-9411  
FAX: 843-448-1943

### AVX Northwest, WA

Tel: 360-669-8746  
FAX: 360-699-8751

### AVX North Central, IN

Tel: 317-848-7153  
FAX: 317-844-9314

### AVX Northeast, MA

Tel: 508-485-8114  
FAX: 508-485-8471

### AVX Mid-Pacific, CA

Tel: 408-436-5400  
FAX: 408-437-1500

### AVX Southwest, AZ

Tel: 602-539-1496  
FAX: 602-539-1501

### AVX South Central, TX

Tel: 972-669-1223  
FAX: 972-669-2090

### AVX Southeast, NC

Tel: 919-878-6357  
FAX: 919-878-6462

### AVX Canada

Tel: 905-564-8959  
FAX: 905-564-9728

## EUROPE

### AVX Limited, England European Headquarters

Tel: ++44 (0)1252 770000  
FAX: ++44 (0)1252 770001

### AVX S.A., France

Tel: ++33 (1) 69.18.46.00  
FAX: ++33 (1) 69.28.73.87

### AVX GmbH, Germany - AVX

Tel: ++49 (0) 8131 9004-0  
FAX: ++49 (0) 8131 9004-44

### AVX GmbH, Germany - Elco

Tel: ++49 (0) 2741 2990  
FAX: ++49 (0) 2741 299133

### AVX srl, Italy

Tel: ++390 (0)2 614571  
FAX: ++390 (0)2 614 2576

### AVX sro, Czech Republic

Tel: ++420 (0)467 558340  
FAX: ++420 (0)467 2844

## ASIA-PACIFIC

### AVX/Kyocera, Singapore Asia-Pacific Headquarters

Tel: (65) 258-2833  
FAX: (65) 350-4880

### AVX/Kyocera, Hong Kong

Tel: (852) 2-363-3303  
FAX: (852) 2-765-8185

### AVX/Kyocera, Korea

Tel: (82) 2-785-6504  
FAX: (82) 2-784-5411

### AVX/Kyocera, Taiwan

Tel: (886) 2-2516-7010  
FAX: (886) 2-2506-9774

### AVX/Kyocera, China

Tel: (86) 21-6249-0314-16  
FAX: (86) 21-6249-0313

### AVX/Kyocera, Malaysia

Tel: (60) 4-228-1190  
FAX: (60) 4-228-1196

### Elco, Japan

Tel: 045-943-2906/7  
FAX: 045-943-2910

### Kyocera, Japan

Tel: (81) 75-593-4518  
FAX: (81) 75-502-2705

### Contact:

