

MOS FIELD EFFECT TRANSISTOR 2SK2414, 2SK2414-Z

SWITCHING N-CHANNEL POWER MOS FET INDUSTRIAL USE

DESCRIPTION

The 2SK2414 is N-Channel MOS Field Effect Transistor designed for high voltage switching applications.

FEATURES

- Low On-Resistance
 $R_{DS(on)1} = 70 \text{ m}\Omega \text{ MAX. (@ } V_{GS} = 10 \text{ V, } I_D = 5.0 \text{ A)}$
 $R_{DS(on)2} = 95 \text{ m}\Omega \text{ MAX. (@ } V_{GS} = 4 \text{ V, } I_D = 5.0 \text{ A)}$
- Low C_{iss} $C_{iss} = 840 \text{ pF TYP.}$
- Built-in G-S Gate Protection Diodes
- High Avalanche Capability Ratings

QUALITY GRADE

Standard

Please refer to "Quality grade on NEC Semiconductor Devices" (Document number IEI-1209) published by NEC Corporation to know the specification of quality grade on the devices and its recommended applications.

ABSOLUTE MAXIMUM RATINGS ($T_A = 25 \text{ }^\circ\text{C}$)

Drain to Source Voltage	V_{DSS}	60	V
Gate to Source Voltage	V_{GSS}	± 20	V
Drain Current (DC)	$I_{D(DC)}$	± 10	A
Drain Current (pulse)*	$I_{D(pulse)}$	± 40	A
Total Power Dissipation ($T_c = 25 \text{ }^\circ\text{C}$)	P_{T1}	20	W
Total Power Dissipation ($T_A = 25 \text{ }^\circ\text{C}$)	P_{T2}	1.0	W
Channel Temperature	T_{ch}	150	$^\circ\text{C}$
Storage Temperature	T_{stg}	-55 to +150	$^\circ\text{C}$
Single Avalanche Current**	I_{AS}	10	A
Single Avalanche Energy**	E_{AS}	10	mJ

* $PW \leq 10 \text{ } \mu\text{s}$, Duty Cycle $\leq 1 \%$

** Starting $T_{ch} = 25 \text{ }^\circ\text{C}$, $R_G = 25 \text{ } \Omega$, $V_{GS} = 20 \text{ V} \rightarrow 0$

PACKAGE DIMENSIONS (in millimeter)

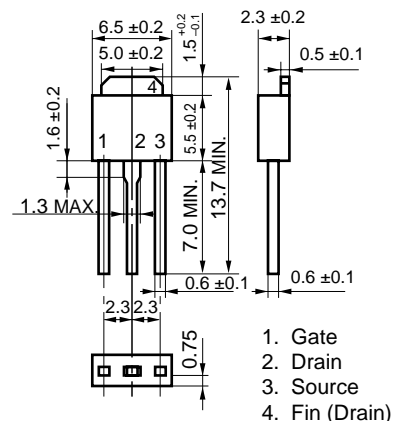

MP-3

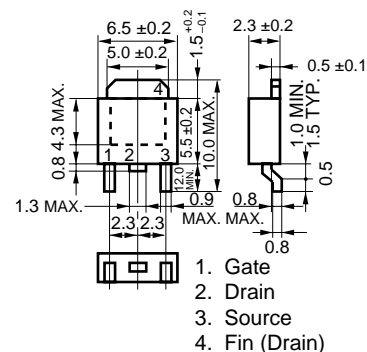

MP-3Z (SURFACE MOUNT TYPE)

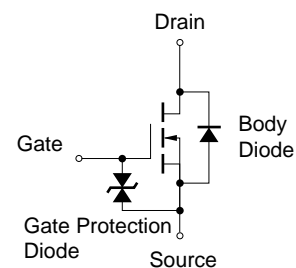

The information in this document is subject to change without notice.

ELECTRICAL CHARACTERISTICS (Ta = 25 °C)

CHARACTERISTIC	SYMBOL	MIN.	TYP.	MAX.	UNIT	TEST CONDITIONS
Drain to Source On-Resistance	$R_{DS(on)1}$		52	70	mΩ	$V_{GS} = 10\text{ V}, I_D = 5.0\text{ A}$
Drain to Source On-Resistance	$R_{DS(on)2}$		68	95	mΩ	$V_{GS} = 4\text{ V}, I_D = 5.0\text{ A}$
Gate to Source Cutoff Voltage	$V_{GS(off)}$	1.0	1.6	2.0	V	$V_{DS} = 10\text{ V}, I_D = 1\text{ mA}$
Forward Transfer Admittance	$ y_{fs} $	7.0	12		S	$V_{DS} = 10\text{ V}, I_D = 5.0\text{ A}$
Drain Leakage Current	I_{DSS}			10	μA	$V_{DS} = 60\text{ V}, V_{GS} = 0$
Gate to Source Leakage Current	I_{GSS}			±10	μA	$V_{GS} = \pm 20\text{ V}, V_{DS} = 0$
Input Capacitance	C_{iss}		860		pF	$V_{DS} = 10\text{ V}$
Output Capacitance	C_{oss}		440		pF	$V_{GS} = 0$
Reverse Transfer Capacitance	C_{rss}		110		pF	$f = 1\text{ MHz}$
Turn-On Delay Time	$t_{d(on)}$		15		ns	$I_D = 5.0\text{ A}$
Rise Time	t_r		90		ns	$V_{GS(on)} = 10\text{ V}$
Turn-Off Delay Time	$t_{d(off)}$		75		ns	$V_{DD} = 30\text{ V}$
Fall Time	t_f		35		ns	$R_G = 10\ \Omega$
Total Gate Charge	Q_G		24		nC	$I_D = 10\text{ A}$
Gate to Source Charge	Q_{GS}		2.6		nC	$V_{DD} = 48\text{ V}$
Gate to Drain Charge	Q_{GD}		6.0		nC	$V_{GS} = 10\text{ V}$
Body Diode Forward Voltage	$V_{F(S-D)}$		1.0		V	$I_F = 10\text{ A}, V_{GS} = 0$
Reverse Recovery Time	t_{rr}		85		ns	$I_F = 10\text{ A}, V_{GS} = 0$
Reverse Recovery Charge	Q_{rr}		220		nC	$di/dt = 50\text{ A}/\mu\text{s}$

Test Circuit 1 Avalanche Capability

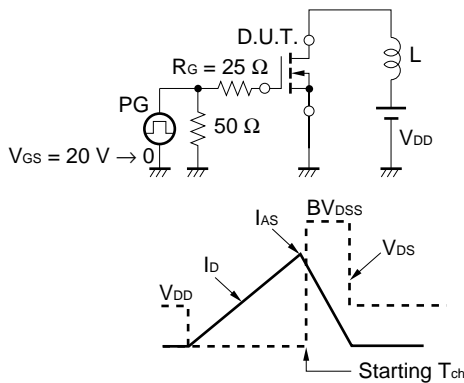

Test Circuit 2 Switching Time

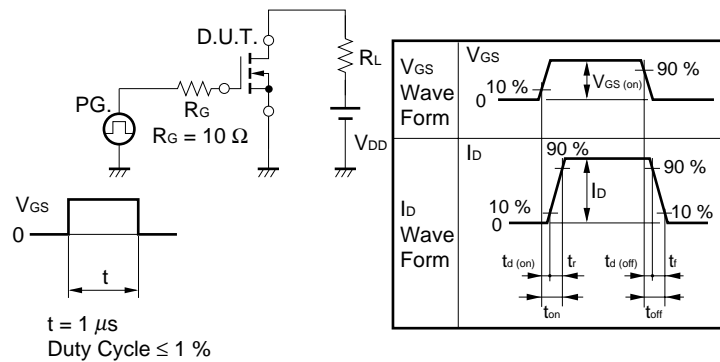

Test Circuit 3 Gate Charge

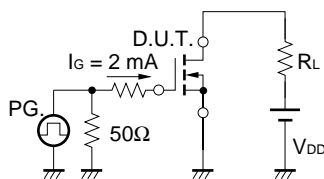

The application circuits and their parameters are for references only and are not intended for use in actual design-in's.

TYPICAL CHARACTERISTICS (T_A = 25 °C)

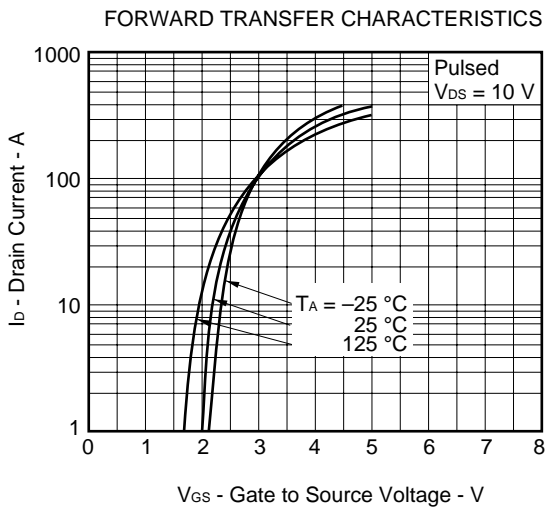
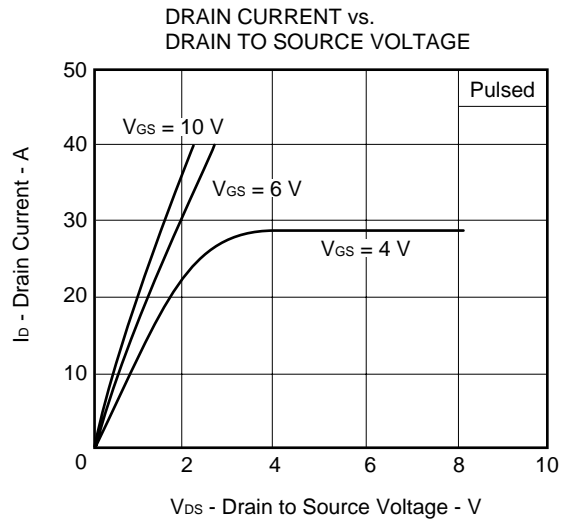
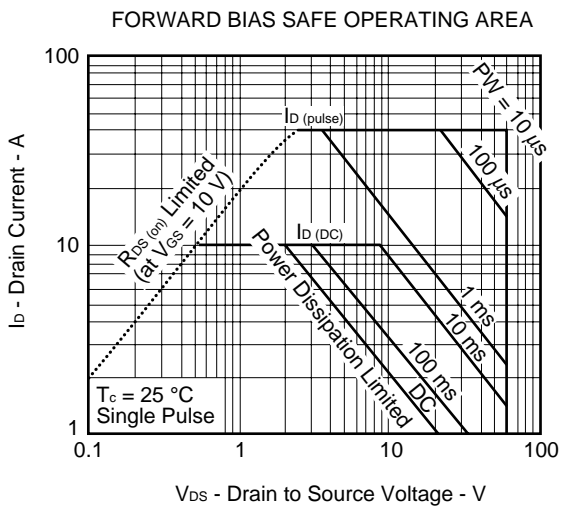
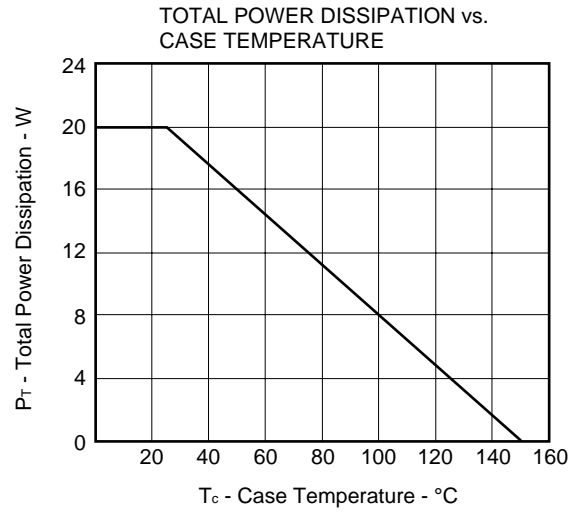
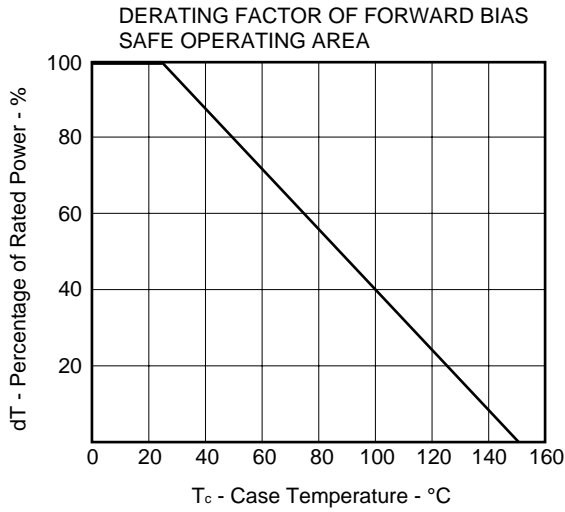

TRANSIENT THERMAL RESISTANCE vs. PULSE WIDTH

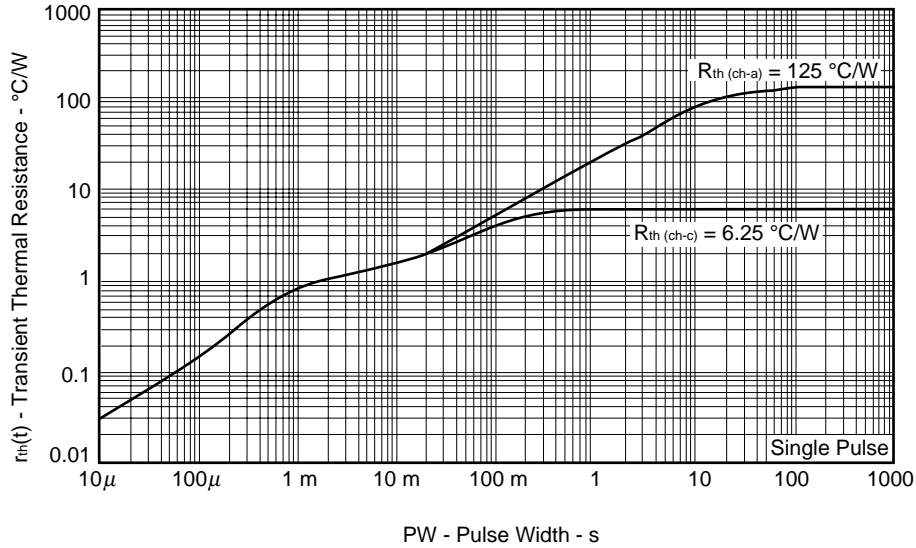

FORWARD TRANSFER ADMITTANCE vs. DRAIN CURRENT

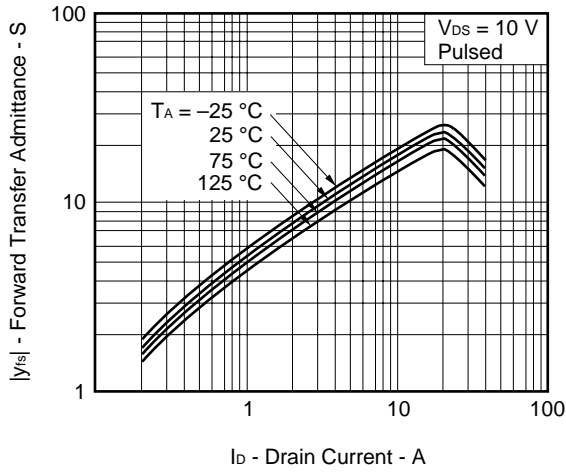

DRAIN TO SOURCE ON-STATE RESISTANCE vs. GATE TO SOURCE VOLTAGE

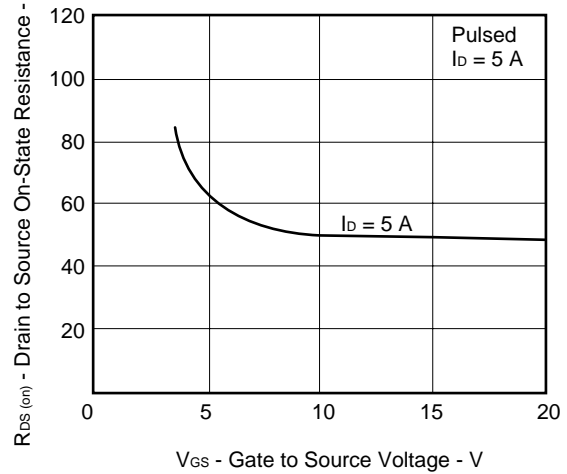

DRAIN TO SOURCE ON-STATE RESISTANCE vs. DRAIN CURRENT

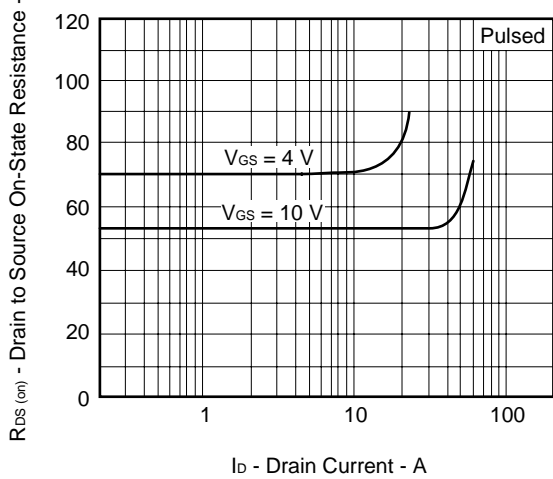

GATE TO SOURCE CUTOFF VOLTAGE vs. CHANNEL TEMPERATURE

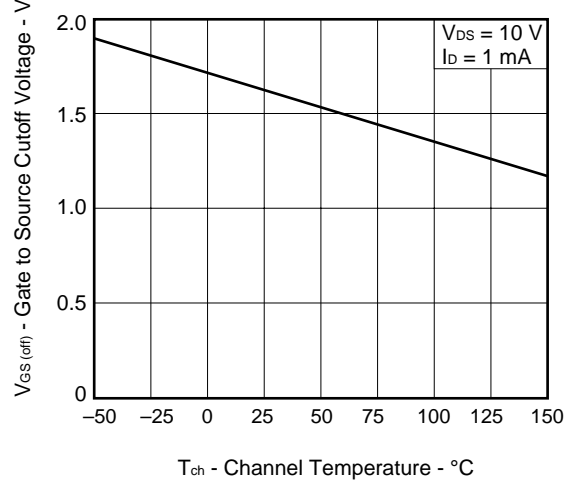

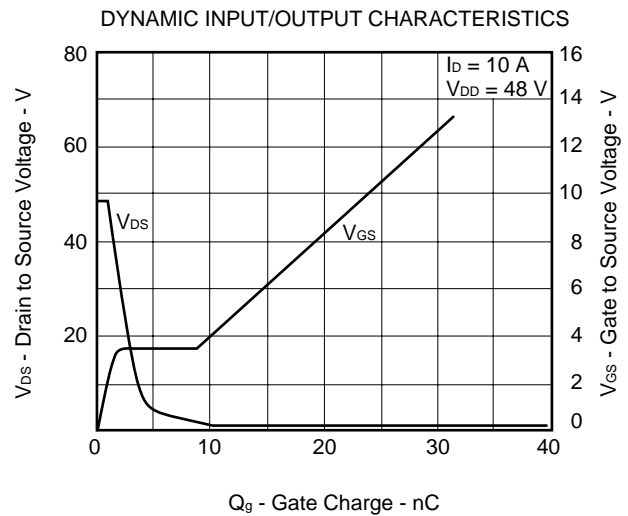
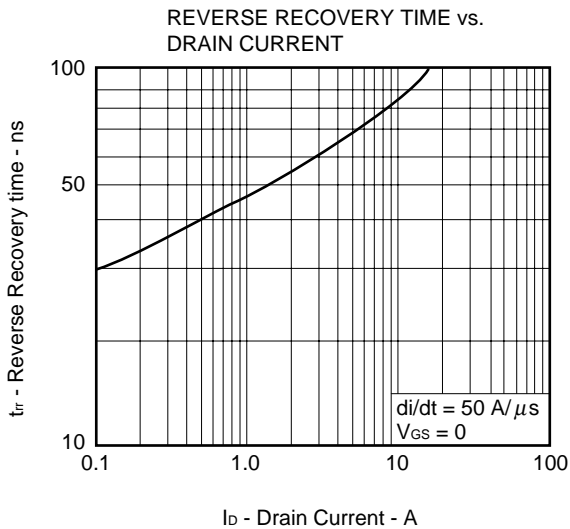
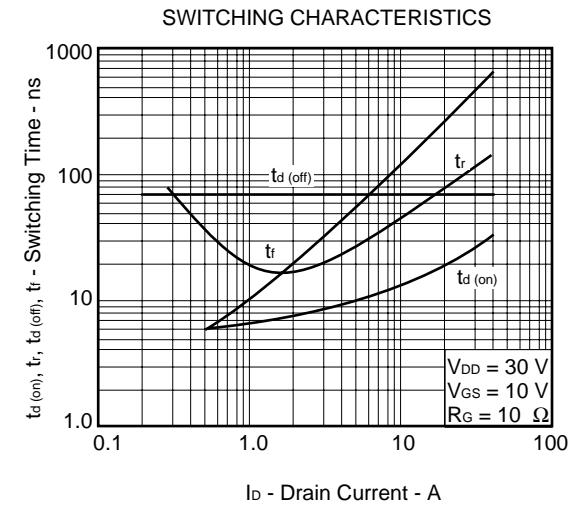
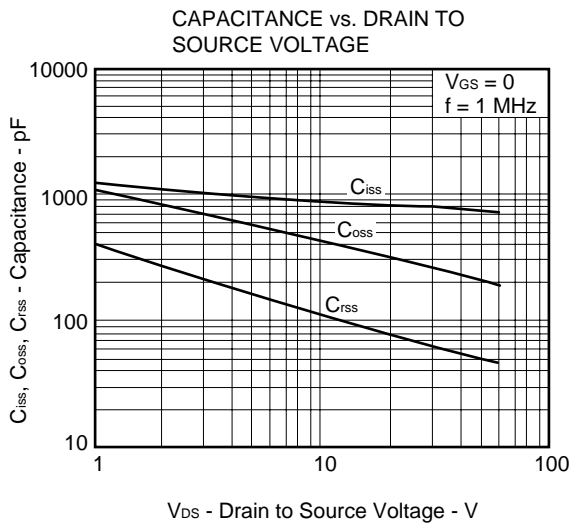
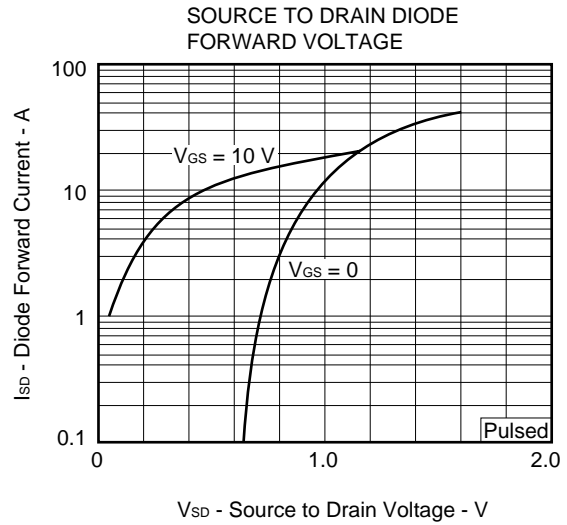
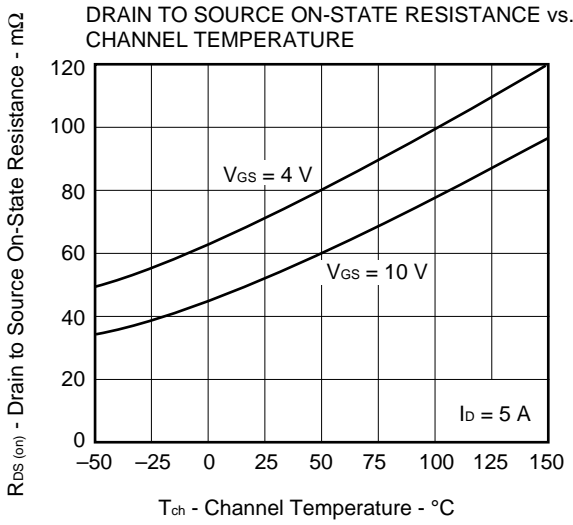

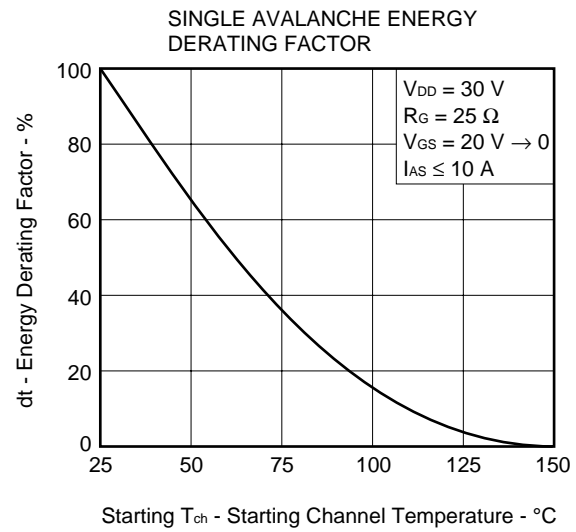
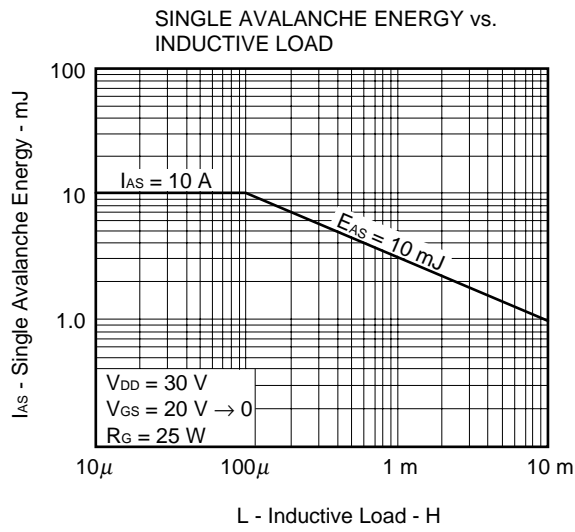

REFERENCE

Document Name	Document No.
NEC semiconductor device reliability/quality control system.	C11745E
Quality grade on NEC semiconductor devices.	C11531E
Semiconductor device mounting technology manual.	C10535E
IC package manual.	C10943X
Guide to quality assurance for semiconductor devices.	MEI-1202
Semiconductor selection guide.	X10679E
Power MOS FET features and application switching power supply.	D12971E
Application circuits using Power MOS FET.	D12972E
Safe operating area of Power MOS FET.	D13085E

The diode connected between the gate and source of the transistor serves as a protector against ESD. When this device is actually used, an additional protection circuit is externally required if a voltage exceeding the rated voltage may be applied to this device.

[MEMO]

No part of this document may be copied or reproduced in any form or by any means without the prior written consent of NEC Corporation. NEC Corporation assumes no responsibility for any errors which may appear in this document.

NEC Corporation does not assume any liability for infringement of patents, copyrights or other intellectual property rights of third parties by or arising from use of a device described herein or any other liability arising from use of such device. No license, either express, implied or otherwise, is granted under any patents, copyrights or other intellectual property rights of NEC Corporation or others.

While NEC Corporation has been making continuous effort to enhance the reliability of its semiconductor devices, the possibility of defects cannot be eliminated entirely. To minimize risks of damage or injury to persons or property arising from a defect in an NEC semiconductor device, customers must incorporate sufficient safety measures in its design, such as redundancy, fire-containment, and anti-failure features.

NEC devices are classified into the following three quality grades:

"Standard", "Special", and "Specific". The Specific quality grade applies only to devices developed based on a customer designated "quality assurance program" for a specific application. The recommended applications of a device depend on its quality grade, as indicated below. Customers must check the quality grade of each device before using it in a particular application.

Standard: Computers, office equipment, communications equipment, test and measurement equipment, audio and visual equipment, home electronic appliances, machine tools, personal electronic equipment and industrial robots

Special: Transportation equipment (automobiles, trains, ships, etc.), traffic control systems, anti-disaster systems, anti-crime systems, safety equipment and medical equipment (not specifically designed for life support)

Specific: Aircrafts, aerospace equipment, submersible repeaters, nuclear reactor control systems, life support systems or medical equipment for life support, etc.

The quality grade of NEC devices is "Standard" unless otherwise specified in NEC's Data Sheets or Data Books. If customers intend to use NEC devices for applications other than those specified for Standard quality grade, they should contact an NEC sales representative in advance.

Anti-radioactive design is not implemented in this product.