

Current Sensor: ACS750xCA-050

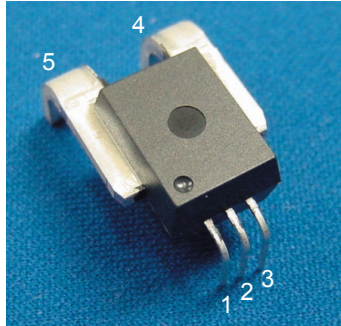

Pin 1: V_{CC} Terminal 4: I_{p+}
Pin 2: Gnd Terminal 5: I_{p-}
Pin 3: Output

ABSOLUTE MAXIMUM RATINGS

| | |
|------------------------------------|---------------|
| Operating Temperature | |
| S | -20 to +85°C |
| L | -40 to +150°C |
| Supply Voltage, V_{CC} | 16 V |
| Output Voltage | 16 V |
| Output Current Source | 3 mA |
| Output Current Sink | 10 mA |
| Maximum Storage Temperature | 170°C |
| Maximum Junction Temperature | 165°C |

Always order by complete part number:

ACS750SCA-050
ACS750LCA-050

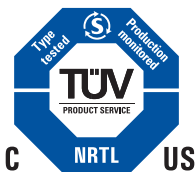

TÜV America
Certificate Number:
U8V 04 11 54214 002

The Allegro ACS750 family of current sensors provides economical and precise solutions for current sensing in industrial, commercial, automotive, and communications systems. The device package allows easy implementation by the customer. Typical applications include: motor control, load detection and management, switched mode power supplies, and overcurrent fault protection.

The sensor consists of a precision linear Hall IC, which is optimized to an internal magnetic circuit to increase device sensitivity. The combination of a precisely controlled self-aligning assembly process (patents pending), and the factory programmed precision of the linear Hall sensor, result in high-level performance and product uniformity.

The primary conductor used for current sensing (terminals 4 and 5) is designed for extremely low power loss. These power terminals also are electrically isolated from the sensor leads (pins 1, 2, and 3). This allows the ACS750 family of sensors to be used in applications requiring electrical isolation, without using optoisolators or other costly isolation techniques.

The output of this device has a positive slope ($>V_{CC}/2$) when an increasing current flows from terminal 4 to terminal 5.

The ACS750 family is lead-free. All leads are coated with 100% matte tin, and there is no lead inside the package. The heavy gauge leadframe is made of oxygen-free copper.

Features and Benefits

- Monolithic Hall IC for high reliability
- Single +5 V supply
- High isolation voltage
- Lead-free
- UL recognized
- Automotive temperature range available
- End-of-line factory-trimmed for gain and offset
- Ultra-low power loss: low resistance of primary conductor
- Ratiometric output from supply voltage
- Low thermal drift of offset voltage
- On-chip transient protection
- Small package size, with easy mounting capability

Applications

- Industrial systems
- Motor control
- Power conversion
- Battery monitors
- Automotive systems

Current Sensor: ACS750xCA-050

Functional Block Diagram

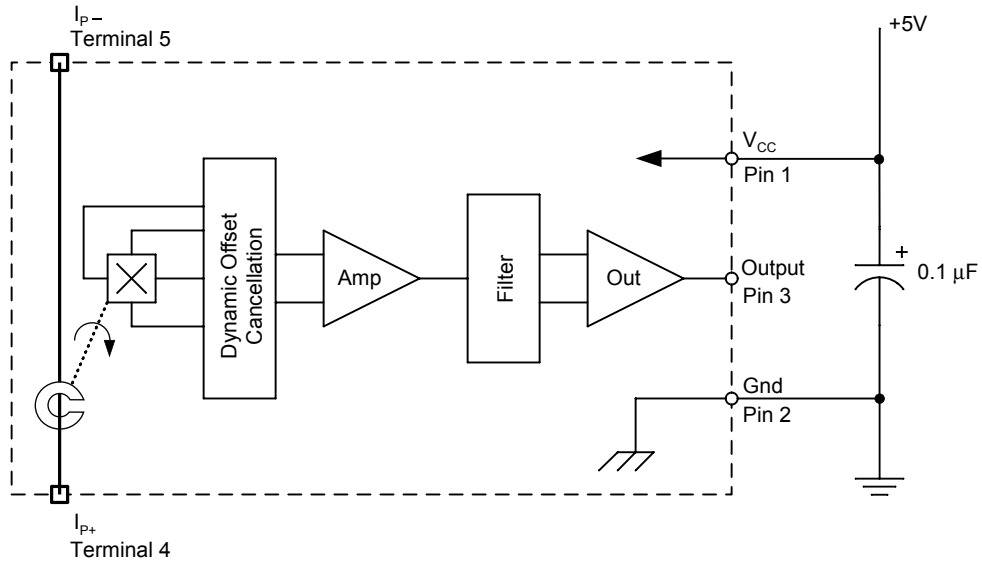

Current Sensor: ACS750xCA-050

ELECTRICAL CHARACTERISTICS, over temperature unless otherwise stated

| Characteristic | Symbol | Test Conditions | Min. | Typ. | Max. | Units |
|------------------------------|---------------|---------------------------------------|------|------|------|-------------|
| Primary Sensed Current | I_P | | -50 | - | 50 | A |
| Supply Voltage | V_{CC} | | 4.5 | 5.0 | 5.5 | V |
| Supply Current | I_{CC} | $V_{CC} = 5.0$ V, output open | - | 7 | 10 | mA |
| Output Resistance | R_{OUT} | $I_{OUT} = 1.2$ mA | - | 1 | 2 | Ω |
| Primary Conductor Resistance | $R_{PRIMARY}$ | $I_P = \pm 100$ A, $T_A = 25^\circ$ C | - | 130 | - | $\mu\Omega$ |
| Isolation Voltage | V_{ISO} | Pins 1-3 and 4-5, 60 Hz, 1 minute | 3.0 | - | - | kV |

PERFORMANCE CHARACTERISTICS, -20° C to $+85^\circ$ C, $V_{CC} = 5$ V unless otherwise specified

| | | | | | | |
|--|----------------|---|-----|-----------|-----------|---------|
| Propagation time | t_{PROP} | $I_P = \pm 50$ A, $T = +25^\circ$ C | - | 4 | - | μ s |
| Response time | $t_{RESPONSE}$ | $I_P = \pm 50$ A, $T = +25^\circ$ C | - | 27 | - | μ s |
| Rise time | t_r | $I_P = \pm 50$ A, $T = +25^\circ$ C | - | 26 | - | μ s |
| Frequency Bandwidth | f | -3 dB, $T = 25^\circ$ C | - | 13 | - | kHz |
| Sensitivity | Sens | $\pm I_P$, $T = 25^\circ$ C | 39 | 40 | 42 | mV/A |
| | | $\pm I_P$ | 36 | - | 44 | mV/A |
| Noise | V_{NOISE} | Peak-to-peak, $T = 25^\circ$ C External filter BW = 24 kHz | - | 14 | - | mV |
| Nonlinearity | E_{LIN} | $\pm I_P$ | - | - | ± 5 | % |
| Symmetry | E_{SYM} | $\pm I_P$ | 99 | 102 | 105 | % |
| Zero Current Output Voltage | $V_{OUT(Q)}$ | $I = 0$ A, $T = 25^\circ$ C | - | 2.5 | - | V |
| Electrical Offset Voltage (Magnetic error not included) | V_{OE} | $I = 0$ A, $T = 25^\circ$ C | -60 | - | 60 | mV |
| | | $I = 0$ A | -75 | - | 75 | mV |
| Magnetic Offset Error | V_{OM} | $I = 0$ A, after excursion of 100 A | - | ± 0.3 | ± 0.8 | A |
| Total Output Error (Including all offsets) | E_{TOT} | $\pm I_P$, $T = 25^\circ$ C | - | ± 2 | - | % |
| | | $\pm I_P$ | - | - | ± 13 | % |

PERFORMANCE CHARACTERISTICS, -40° C to $+150^\circ$ C, $V_{CC} = 5$ V unless otherwise specified

| | | | | | | |
|--|----------------|--|-----|---------|-----------|---------|
| Propagation time | t_{PROP} | $I_P = \pm 50$ A | - | 4 | - | μ s |
| Response time | $t_{RESPONSE}$ | $I_P = \pm 50$ A | - | 27 | - | μ s |
| Rise time | t_r | $I_P = \pm 50$ A | - | 26 | - | μ s |
| Frequency Bandwidth | f | -3 dB, $T = 25^\circ$ C | - | 13 | - | kHz |
| Sensitivity | Sens | $\pm I_P$, $T = 25^\circ$ C | 39 | 40 | 42 | mV/A |
| | | $\pm I_P$, $T = 25^\circ$ C | 33 | - | 46 | mV/A |
| Noise | V_{NOISE} | Peak-to-peak; $T = +25^\circ$ C External filter BW = 40 kHz | - | 14 | - | mV |
| Nonlinearity | E_{LIN} | $\pm I_P$ | - | - | ± 5 | % |
| Symmetry | E_{SYM} | $\pm I_P$ | 99 | 102 | 105 | % |
| Zero Current Output Voltage | $V_{OUT(Q)}$ | $I = 0$ A, $T = 25^\circ$ C | - | 2.5 | - | V |
| Electrical Offset Voltage (Magnetic error not included) | V_{OE} | $I = 0$ A, $T = 25^\circ$ C | -60 | - | 60 | mV |
| | | $I = 0$ A | -90 | - | 90 | mV |
| Magnetic Offset Error | V_{OM} | $I = 0$ A, after excursion of 100 A | - | 0.3 | ± 0.8 | A |
| Total Output Error (Including all offsets) | E_{TOT} | $\pm I_P$, $T = 25^\circ$ C | - | ± 2 | - | % |
| | | $\pm I_P$ | - | - | ± 15 | % |

Current Sensor: ACS750xCA-050

Typical Performance Characteristics

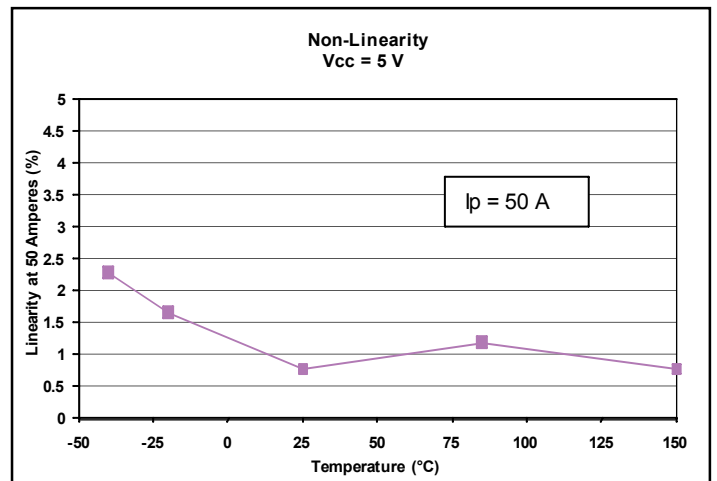
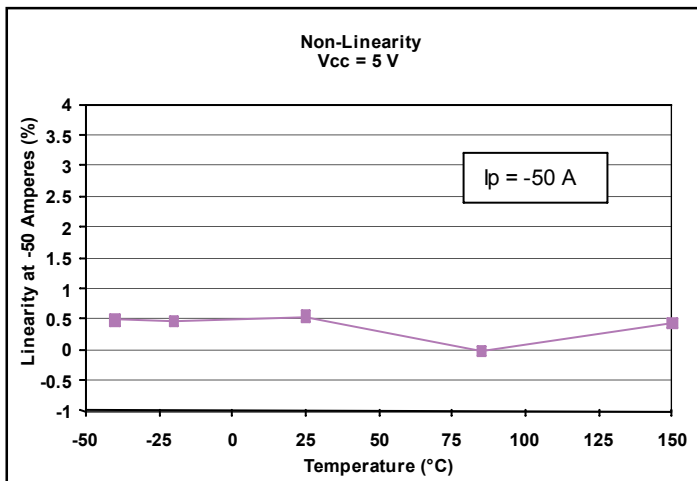
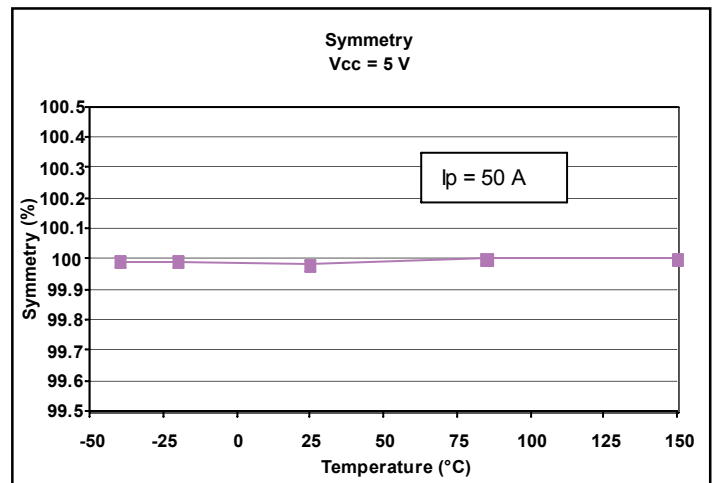
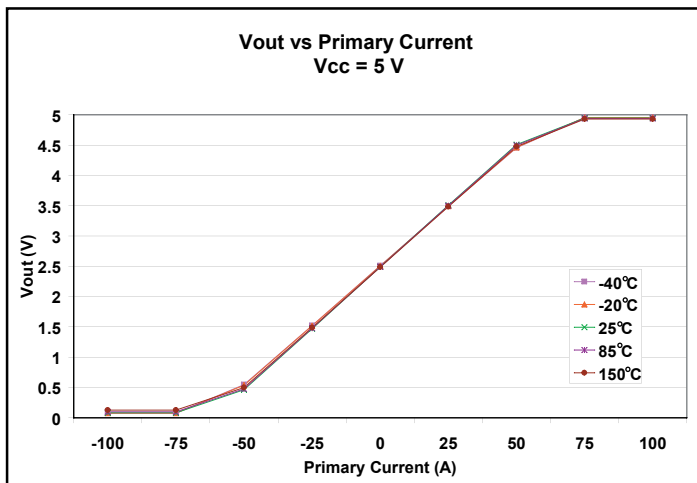
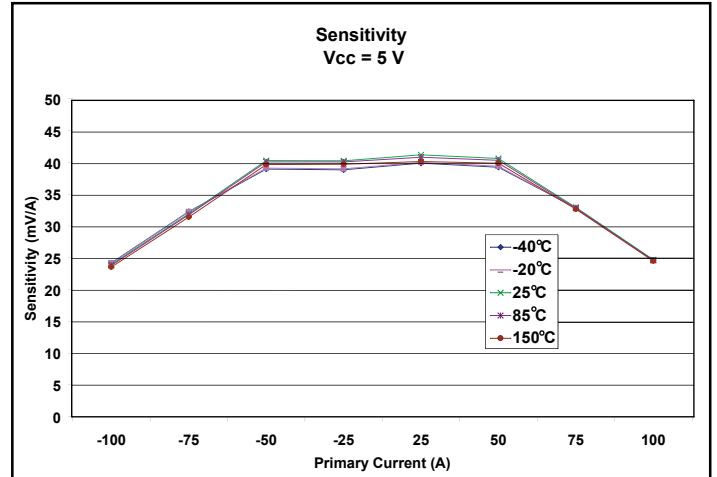
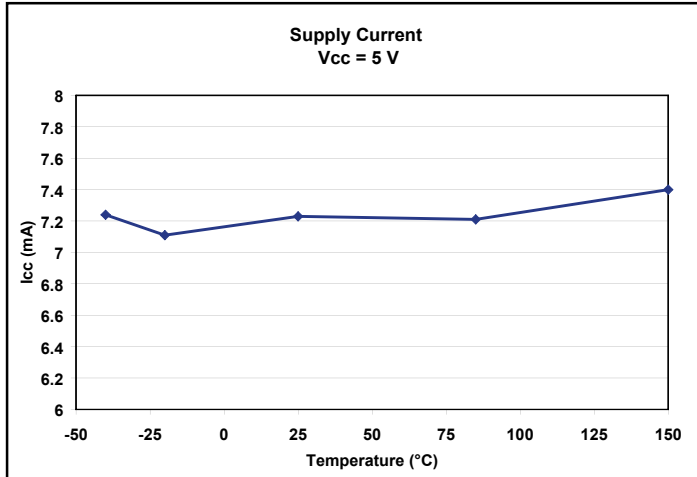

Current Sensor: ACS750xCA-050

Typical Performance Characteristics

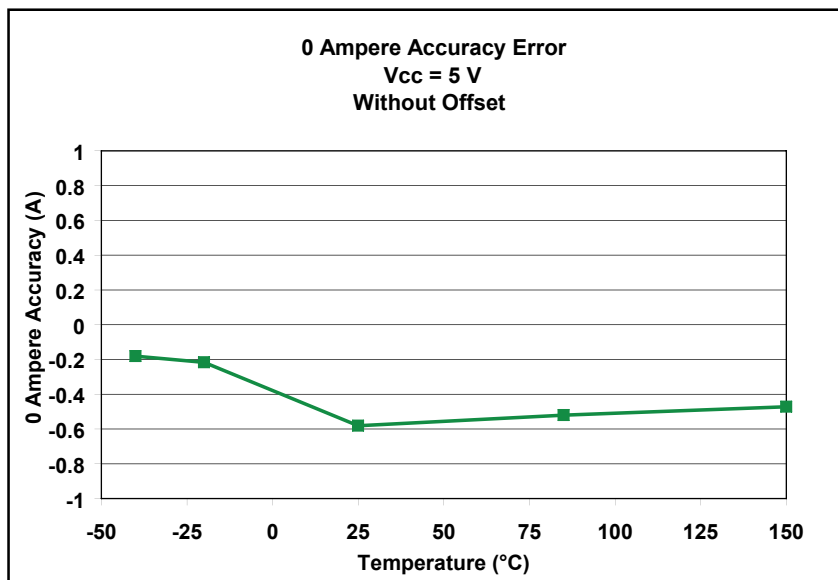
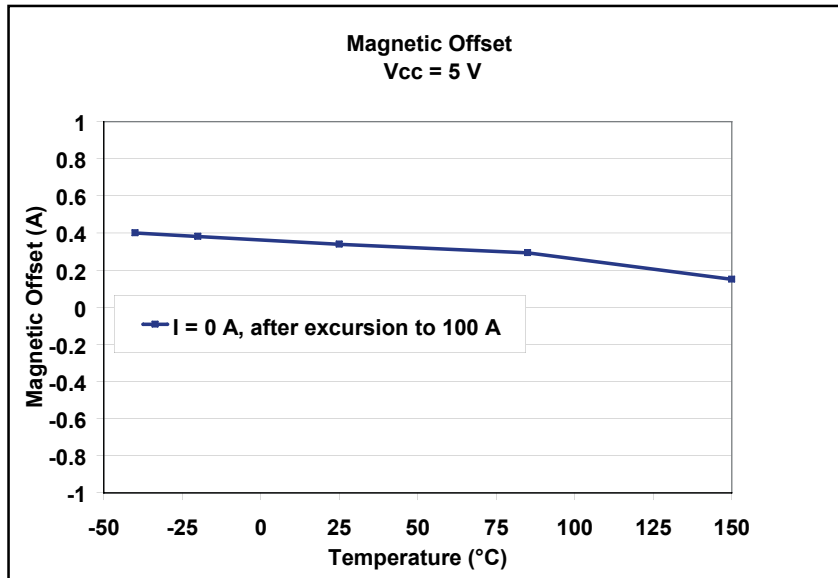

Current Sensor: ACS750xCA-050

Definitions of Accuracy Characteristics

Sensitivity (Sens): The change in sensor output in response to a 1 A change through the primary conductor. The sensitivity is the product of the magnetic circuit sensitivity (G/A) and the linear IC amplifier gain (mV/G). The linear IC amplifier gain is trimmed at the factory to optimize the sensitivity (mV/A) for the full-scale current of the device.

Noise (V_{NOISE}): The product of the linear IC amplifier gain (mV/G) and the noise floor for the Allegro Hall effect linear IC (≈ 1 G). The noise floor is derived from the thermal and shot noise observed in Hall elements. Dividing the noise (mV) by the sensitivity (mV/A) provides the smallest current that the device is able to resolve.

Linearity (E_{LIN}): The degree to which the voltage output from the sensor varies in direct proportion to the primary current through its full-scale amplitude. Linearity reveals the maximum deviation from the ideal transfer curve for this transducer. Nonlinearity in the output can be attributed to the gain variation across temperature and saturation of the flux concentrator approaching the full-scale current. The following equation is used to derive the linearity:

$$100 \left\{ 1 - \left[\frac{\Delta \text{ gain} \times \% \text{ sat} (V_{\text{out_full-scale amperes}} - V_{\text{OUT(Q)}})}{2 (V_{\text{out_half-scale amperes}} - V_{\text{OUT(Q)}})} \right] \right\}$$

where

Δ gain = the gain variation as a function of temperature changes from 25°C,

% sat = the percentage of saturation of the flux concentrator, which becomes significant as the current being sensed approaches full-scale $\pm I_p$, and

$V_{\text{out_full-scale amperes}}$ = the output voltage (V) when the sensed current approximates full-scale $\pm I_p$.

Symmetry (E_{SYM}): The degree to which the absolute voltage output from the sensor varies in proportion to either a positive or negative full-scale primary current. The following equation is used to derive symmetry:

$$100 \left[\frac{V_{\text{out_+full-scale amperes}} - V_{\text{OUT(Q)}}}{V_{\text{OUT(Q)}} - V_{\text{out_full-scale amperes}}} \right]$$

Quiescent output voltage ($V_{\text{OUT(Q)}}$): The output of the sensor when the primary current is zero. For a unipolar supply voltage, it nominally remains at $V_{\text{CC}}/2$. Thus, $V_{\text{CC}} = 5$ V translates into $V_{\text{OUT(Q)}} = 2.5$ V. Variation in $V_{\text{OUT(Q)}}$ can be attributed to the resolution of the Allegro linear IC quiescent voltage trim, magnetic hysteresis, and thermal drift.

Electrical offset voltage (V_{OE}): The deviation of the device output from its ideal quiescent value of $V_{\text{CC}}/2$ due to nonmagnetic causes.

Magnetic offset error (V_{OM}): The magnetic offset is due to the residual magnetism (remnant field) of the core material. The magnetic offset error is highest when the magnetic circuit has been saturated, usually when the device has been subjected to a full-scale or high-current overload condition. The magnetic offset is largely dependent on the material used as a flux concentrator. The larger magnetic offsets are observed at the lower operating temperatures.

Accuracy (E_{TOT}): The accuracy represents the maximum deviation of the actual output from its ideal value. This is also known as the total output error. The accuracy is illustrated graphically in the Output Voltage versus Current chart on the following page.

Accuracy is divided into four areas:

- **0 A at 25°C:** Accuracy of sensing zero current flow at 25°C, without the effects of temperature.
- **0 A over temperature:** Accuracy of sensing zero current flow including temperature effects.
- **Full-scale current at 25°C:** Accuracy of sensing the full-scale current at 25°C, without the effects of temperature.
- **Full-scale current over Δ temperature:** Accuracy of sensing full-scale current flow including temperature effects.

Current Sensor: ACS750xCA-050

Output voltage vs. current, illustrating sensor accuracy at 0 A and at full-scale current

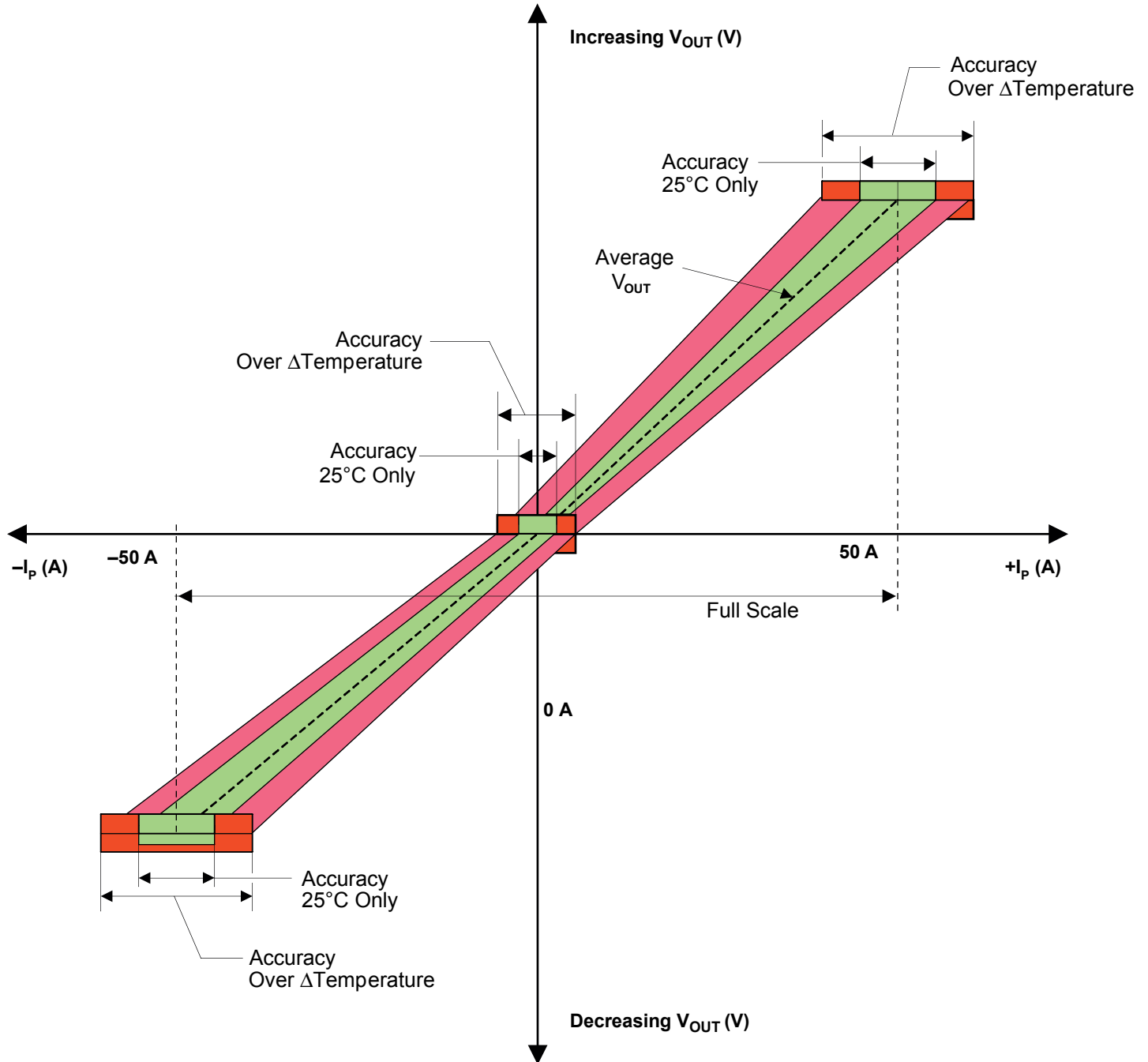

Current Sensor: ACS750xCA-050

Definitions of Dynamic Response Characteristics

Propagation delay (t_{PROP}): The time required for the sensor output to reflect a change in the primary current signal. Propagation delay is attributed to inductive loading within the linear IC package, as well as in the inductive loop formed by the primary conductor geometry. Propagation delay can be considered as a fixed time offset and may be compensated.

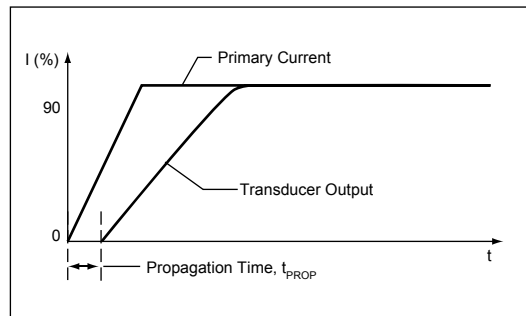

Response time ($t_{RESPONSE}$): The time interval between a) when the primary current signal reaches 90% of its final value, and b) when the sensor reaches 90% of its output corresponding to the applied current.

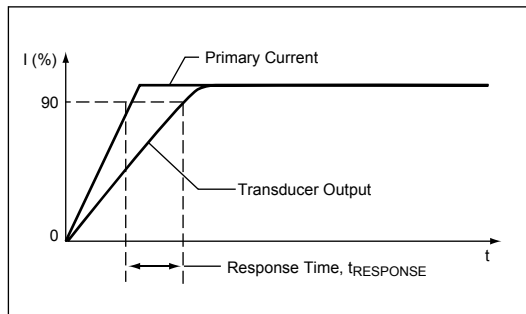

Rise time (t_r): The time interval between a) when the sensor reaches 10% of its full scale value, and b) when it reaches 90% of its full scale value. The rise time to a step response is used to derive the bandwidth of the current sensor, in which $f(-3 \text{ dB}) = 0.35 / t_r$. Both t_r and $t_{RESPONSE}$ are detrimentally affected by eddy current losses observed in the conductive IC ground plane and, to varying degrees, in the ferrous flux concentrator within the current sensor package.

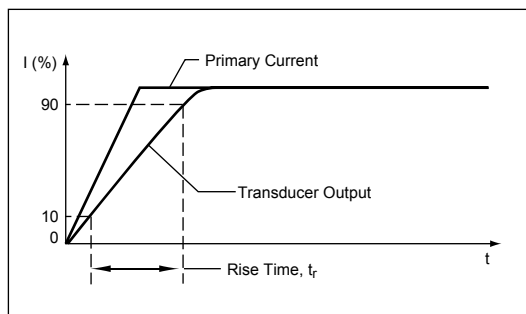

Current Sensor: ACS750xCA-050

Standards and Physical Specifications

| Parameter | Specification |
|--|--|
| Flammability (package molding compound) | UL recognized to UL 94V-0 |
| Safety | UL recognized to EN 50178 |
| Fire and Electric Shock | UL60950-1:2003 EN60950-1:2001 CAN/CSA C22.2 No. 60950-1:2003 |
| Creepage distance, current terminals to sensor pins | 7.25 mm |
| Clearance distance, current terminals to sensor pins | 7.25 mm |
| Package mass | 4.18 g typical |

Peak to Peak Noise, applying low-pass filter to ACS750 output

| Low Pass Filter Break Frequency | Typical Peak to Peak Noise |
|---------------------------------|----------------------------|
| Unfiltered | 22.7 mV |
| 1.4 MHz | 21 mV |
| 24 kHz | 7.1 mV |

Step Response, $I_{\text{PRIMARY}} = 0$ to 30 A

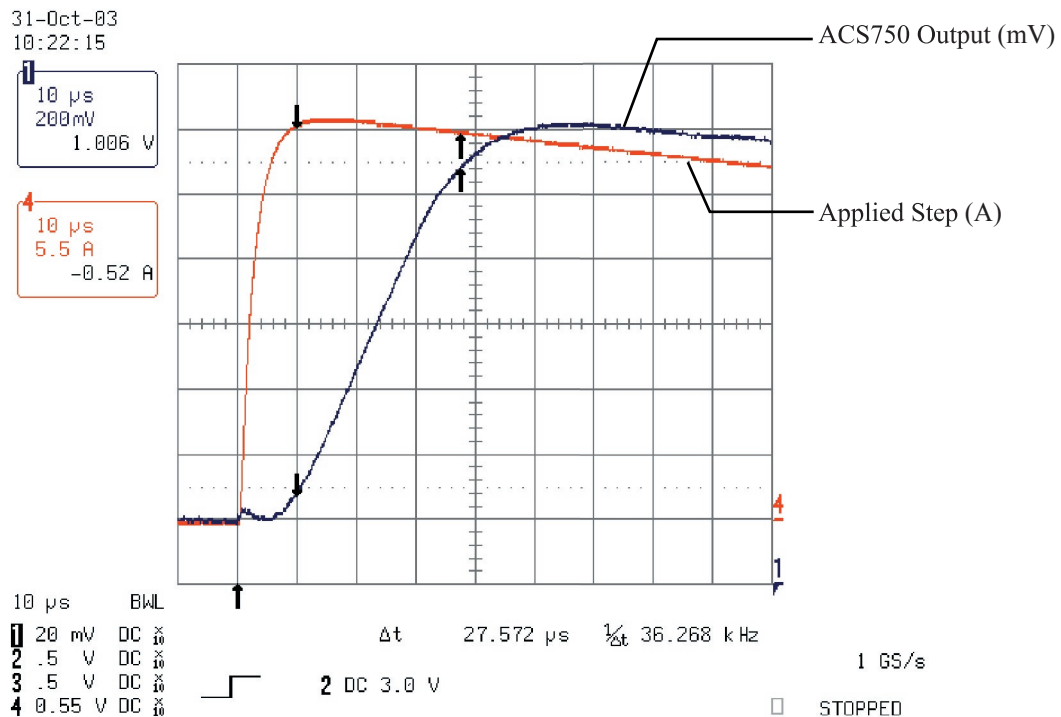

Current Sensor: ACS750xCA-050

Package CA

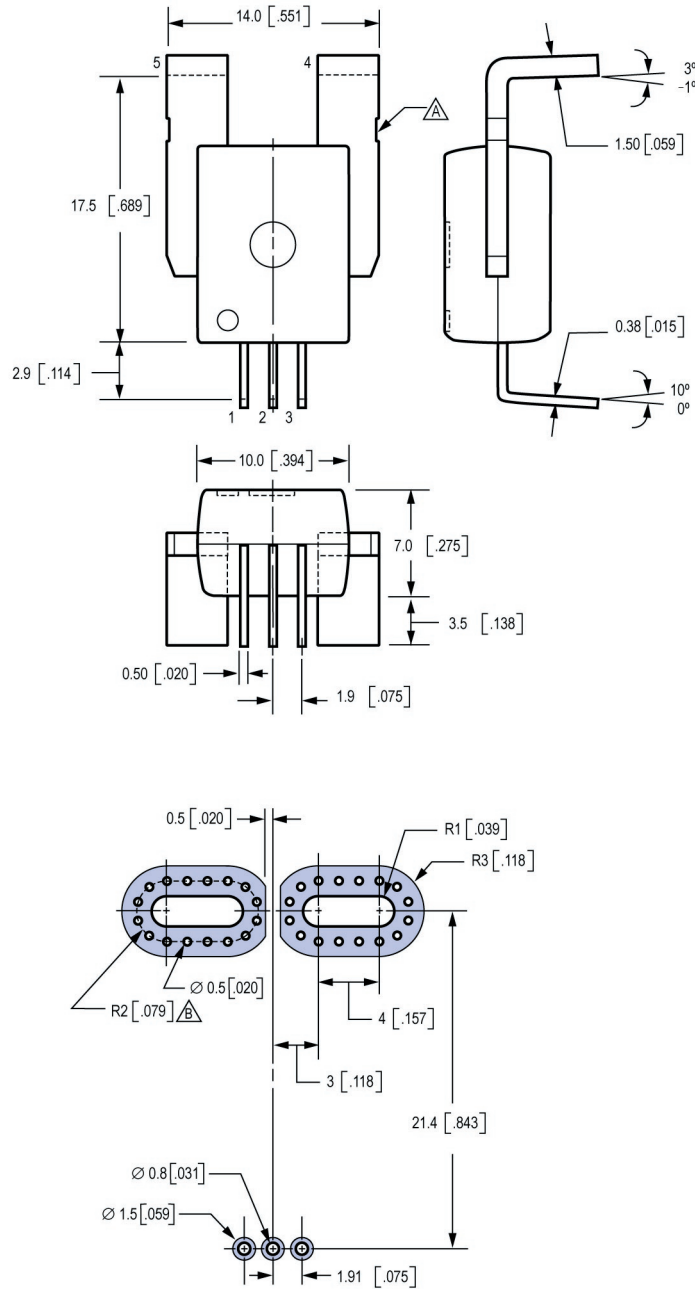

Current Sensor: ACS750xCA-050

The products described herein are manufactured under one or more of the following U.S. patents: 5,045,920; 5,264,783; 5,442,283; 5,389,889; 5,581,179; 5,517,112; 5,619,137; 5,621,319; 5,650,719; 5,686,894; 5,694,038; 5,729,130; 5,917,320; and other patents pending.

Allegro MicroSystems, Inc. reserves the right to make, from time to time, such departures from the detail specifications as may be required to permit improvements in the performance, reliability, or manufacturability of its products. Before placing an order, the user is cautioned to verify that the information being relied upon is current.

Allegro products are not authorized for use as critical components in life-support devices or systems without express written approval.

The information included herein is believed to be accurate and reliable. However, Allegro MicroSystems, Inc. assumes no responsibility for its use; nor for any infringement of patents or other rights of third parties which may result from its use.