

# NAIS

## SLIM POLARIZED RELAY

# TN-RELAYS

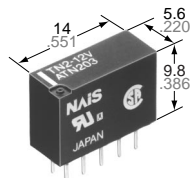

mm inch

### FEATURES

- Small size for minimal PC board mounting requirements
- Small header area makes higher density mounting possible
- High sensitivity: 140 mW nominal operating power (single side stable 3-12 V type)
- Surge voltage withstand: 1500 V FCC Part 68
- Sealed construction allows automatic cleaning
- Self-clinching terminal also available

### SPECIFICATIONS

#### Contact

Arrangement	2 Form C	
Initial contact resistance, max. (By voltage drop 6 V DC 1A)	60 mΩ	
Contact material	Gold-clad silver	
Rating	Nominal switching capacity (resistive load)	1 A 30 V DC, 0.5 A 125 V AC
	Max. switching power (resistive load)	30 W, 62.5 VA
	Max. switching voltage	110 V DC, 125 V AC
	Max. switching current	1 A
	Min. switching capacity ※1	10 μA 10 mV DC
Nominal operating power	Single side stable	140 mW (3 to 12 V DC) 200 mW (24 V DC) 300 mW (48 V DC)
	1 coil latching	100 mW (3 to 12 V DC) 150 mW (24 V DC)
	2 coil latching	200 mW (3 to 12 V DC) 300 mW (24 V DC)
Expected life (min. operations)	Mechanical (at 180 cpm)	10 <sup>8</sup>
	Electrical (at 20 cpm)	1 A 30 V DC resistive load
		0.5 A 125 V AC resistive load

#### Note:

※1 This value can change due to the switching frequency, environmental conditions, and desired reliability level, therefore it is recommended to check this with the actual load.

#### Remarks

- \* Specifications will vary with foreign standards certification ratings.
- \*1 Measurement at same location as "Initial breakdown voltage" section.
- \*2 By resistive method, nominal voltage applied to the coil; contact carrying current: 1 A.
- \*3 Nominal voltage applied to the coil, excluding contact bounce time.
- \*4 Nominal voltage applied to the coil, excluding contact bounce time without diode.

#### Characteristics

Initial insulation resistance*1	Min. 1,000 MΩ (at 500 V DC)		
	Initial breakdown voltage	Between open contacts	750 Vrms for 1 min. (Detection current: 10 mA)
		Between contact and coil	1,000 Vrms for 1 min. (Detection current: 10 mA)
	Between contact sets	1,000 Vrms for 1 min. (Detection current: 10 mA)	
FCC surge voltage between open contacts	1,500 V		
Temperature rise*2 (at 20°C)	Max. 50°C		
Operate time [Set time]*3 (at 20°C)	Max. 3 ms (Approx. 2 ms) [Max. 3 ms (Approx. 2 ms)]		
Release time [Reset time]*4 (at 20°C)	Max. 3 ms (Approx. 1 ms) [Max. 3 ms (Approx. 2 ms)]		
Shock resistance	Functional*5	Min. 490 m/s <sup>2</sup> {50G}	
	Destructive*6	Min. 980 m/s <sup>2</sup> {100G}	
Vibration resistance	Functional*7	176.4 m/s <sup>2</sup> {18G}, 10 to 55 Hz at double amplitude of 3 mm	
	Destructive	294 m/s <sup>2</sup> {30G}, 10 to 55 Hz at double amplitude of 5 mm	
Conditions for operation, transport and storage*8 (Not freezing and condensing at low temperature)	Ambient temperature	-40°C to +70°C -40°F to +158°F	
	Humidity	5 to 85% R.H.	
Unit weight	Approx. 1.5 g .053 oz		

\*5 Half-wave pulse of sine wave: 11 ms; detection time: 10 μs.

\*6 Half-wave pulse of sine wave: 6 ms.

\*7 Detection time: 10 μs.

\*8 Refer to 4. Conditions for operation, transport and storage mentioned in Cautions for use (Page 178).

### ORDERING INFORMATION

Ex. TN 2 — L2 — H — 12V

Contact arrangement	Operating function	Terminal shape	Coil voltage(DC)
2: 2 Form C	Nil: Single side stable L: 1 coil latching L2: 2 coil latching	Nil: Standard PC board terminal H: Self-clinching terminal	3,4,5,5,6,9,12, 24,48*V

\*48 V coil type: Single side stable only

Note: AgPd stationary contact types available for high resistance against contact sticking. When ordering, please add suffix "-3" like TN2-12V-3.

# TYPES AND COIL DATA (at 20°C 68°F)

## 1. Single side stable

Part No.		Nominal voltage, V DC	Pick-up voltage, V DC (max.)	Drop-out voltage, V DC (min.)	Nominal operating current, mA (±10%)	Coil resistance, Ω (±10%)	Nominal operating power, mW	Max. allowable voltage, V DC
Standard PC board terminal	Self-clinching terminal							
TN2-3 V	TN2-H-3 V	3	2.25	0.3	46.7	64.3	140	4.5
TN2-4.5 V	TN2-H-4.5 V	4.5	3.38	0.45	31.1	145	140	6.7
TN2-5 V	TN2-H-5 V	5	3.75	0.5	28.1	178	140	7.5
TN2-6 V	TN2-H-6 V	6	4.5	0.6	23.3	257	140	9
TN2-9 V	TN2-H-9 V	9	6.75	0.9	15.5	579	140	13.5
TN2-12 V	TN2-H-12 V	12	9	1.2	11.7	1,028	140	18
TN2-24 V	TN2-H-24 V	24	18	2.4	8.3	2,880	200	36
TN2-48 V	TN2-H-48 V	48	36	4.8	6.25	7,680	300	57.6

## 2. 1 Coil latching

Part No.		Nominal voltage, V DC	Set voltage, V DC (max.)	Reset voltage, V DC (max.)	Nominal operating current, mA (±10%)	Coil resistance, Ω (±10%)	Nominal operating power, mW	Max. allowable voltage, V DC
Standard PC board terminal	Self-clinching terminal							
TN2-L-3 V	TN2-L-H-3 V	3	2.25	2.25	33.3	90	100	4.5
TN2-L-4.5 V	TN2-L-H-4.5 V	4.5	3.38	3.38	22.2	202.5	100	6.7
TN2-L-5 V	TN2-L-H-5 V	5	3.75	3.75	20	250	100	7.5
TN2-L-6 V	TN2-L-H-6 V	6	4.5	4.5	16.7	360	100	9
TN2-L-9 V	TN2-L-H-9 V	9	6.75	6.75	11.1	810	100	13.5
TN2-L-12 V	TN2-L-H-12 V	12	9	9	8.3	1,440	100	18
TN2-L-24 V	TN2-L-H-24 V	24	18	18	6.3	3,840	150	36

## 3. 2 Coil latching

Part No.		Nominal voltage, V DC	Set voltage, V DC (max.)	Reset voltage, V DC (max.)	Nominal operating current, mA (±10%)	Coil resistance, Ω (±10%)	Nominal operating power, mW	Max. allowable voltage, V DC
Standard PC board terminal	Self-clinching terminal							
TN2-L2-3 V	TN2-L2-H-3 V	3	2.25	2.25	66.7	45	200	4.5
TN2-L2-4.5 V	TN2-L2-H-4.5 V	4.5	3.38	3.38	44.4	101.2	200	6.7
TN2-L2-5 V	TN2-L2-H-5 V	5	3.75	3.75	40	125	200	7.5
TN2-L2-6 V	TN2-L2-H-6 V	6	4.5	4.5	33.3	180	200	9
TN2-L2-9 V	TN2-L2-H-9 V	9	6.75	6.75	22.2	405	200	13.5
TN2-L2-12 V	TN2-L2-H-12 V	12	9	9	16.7	720	200	18
TN2-L2-24 V	TN2-L2-H-24 V	24	18	18	12.5	1,920	300	28.8

### Notes:

1. Specified value of the pick-up, drop-out, set and reset voltage is with the condition of square wave coil pulse.
2. Standard packing: Tube: 50 pcs.; Case: 1,000 pcs.
3. In case of 5 V drive circuit, it is recommended to use 4.5 V type relay.
4. AgPd stationary contact types available for high resistance against contact sticking. When ordering, please add suffix "-3" like TN2-12V-3.

## DIMENSIONS

mm inch

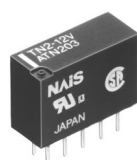

Standard PC board terminal

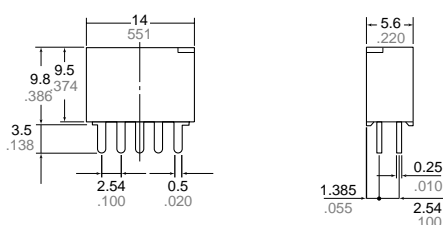

PC board pattern (Copper-side view)

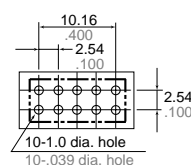

Tolerance: ±0.1 ±.004

Self-clinching terminal

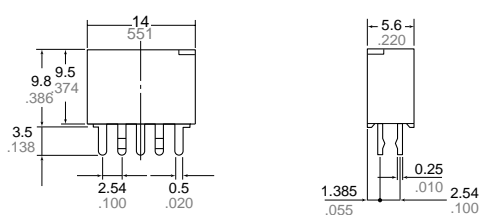

Schematic (Bottom view)

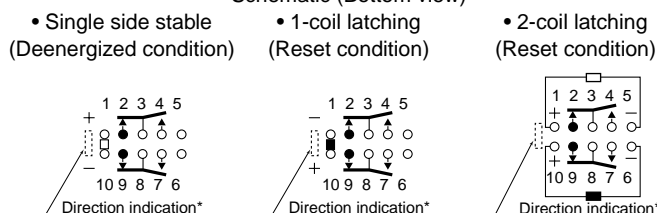

General tolerance: ±0.3 ±.012

\*Orientation stripe located on top of relay

REFERENCE DATA

1. Maximum switching capacity

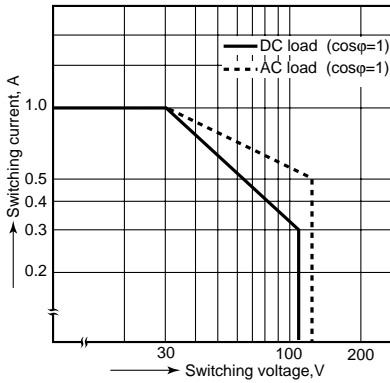

2. Life curve

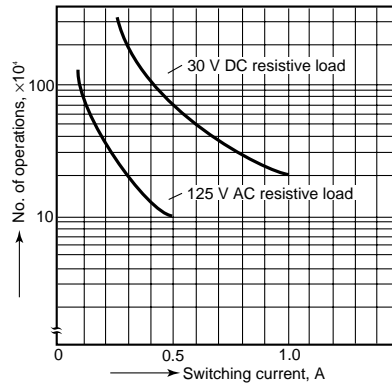

3. Mechanical life

Tested sample: TN2-12V, 10 pcs.

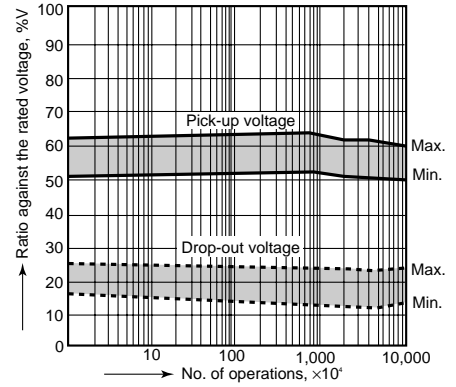

4. Electrical life (DC load)

Tested sample: TN2-12V, 10 pcs.  
Condition: 1 A 30 V DC resistive load, 20 cpm

Change of pick-up and drop-out voltage

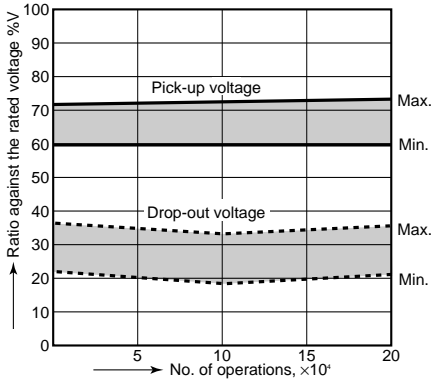

Change of contact resistance

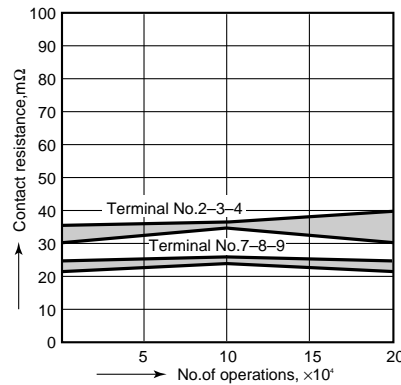

5. Coil temperature rise

Tested sample: TN2-12V  
Point measured: Inside the coil  
Ambient temperature: Room temperature (25° to 26°C), 70°C (77° to 79°F), 158°F

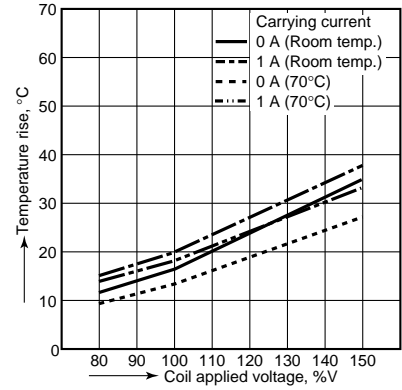

6. Operate/release time characteristics

Tested sample: TN2-12V, 5 pcs.

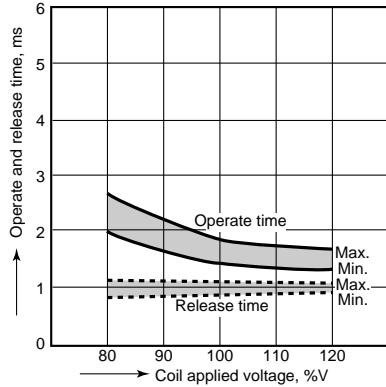

7. Set/reset time characteristics

Tested sample: TN2-L2-12V, 5 pcs.

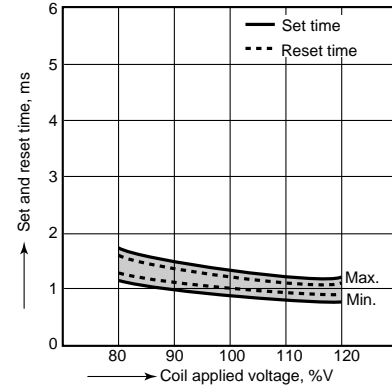

8. Distribution of pick-up and drop-out voltages

Tested sample: TN2-12V, 40 pcs.

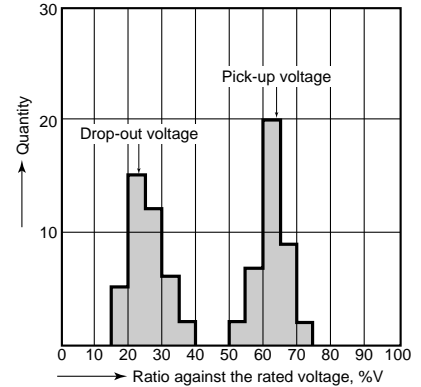

9. Distribution of set and reset voltage

Tested sample: TN2-L2-12V, 32 pcs.

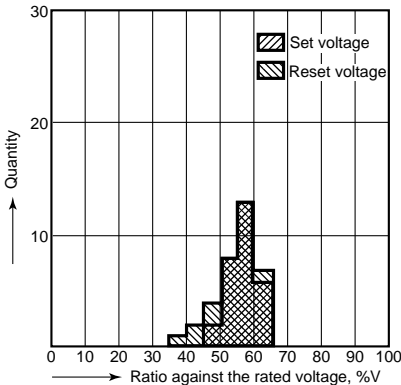

10. Ambient temperature characteristics

Tested sample: TN2-12V, 5 pcs.

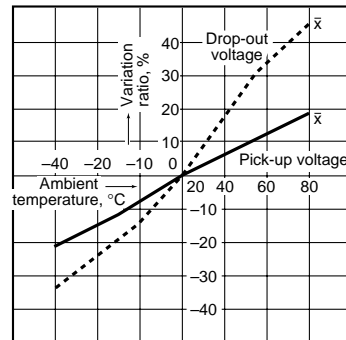

11. Distribution of contact resistance

Tested sample: TN2-12V, 38 pcs. (38x4 contacts)

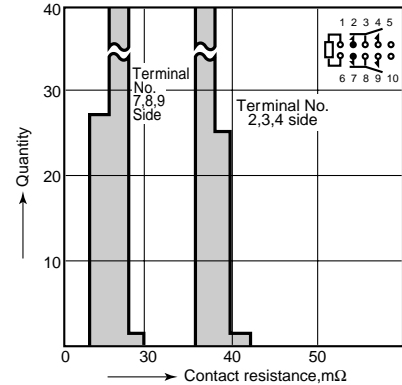

12-(1). Malfunctional shock (single side stable)  
Tested sample: TN2-12V, 6 pcs.

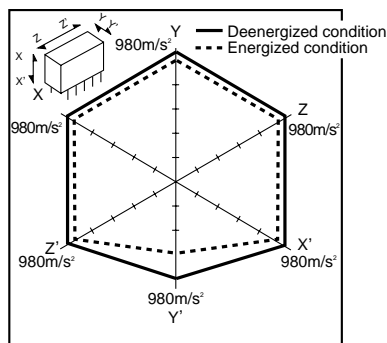

12-(2). Malfunctional shock (latching)  
Tested sample: TN2-L2-12V, 6 pcs.

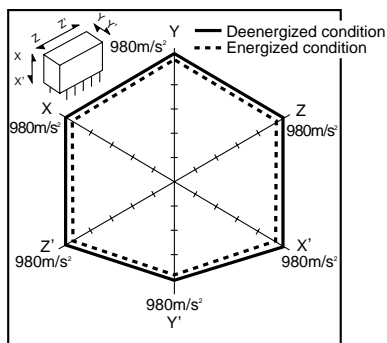

13-(1). Influence of adjacent mounting

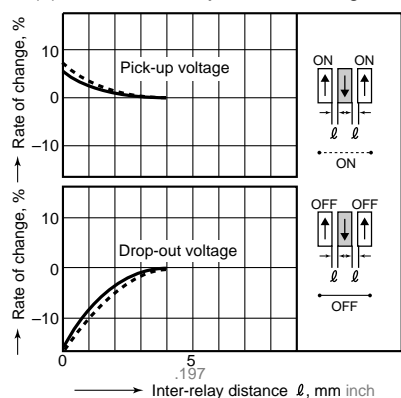

13-(2). Influence of adjacent mounting

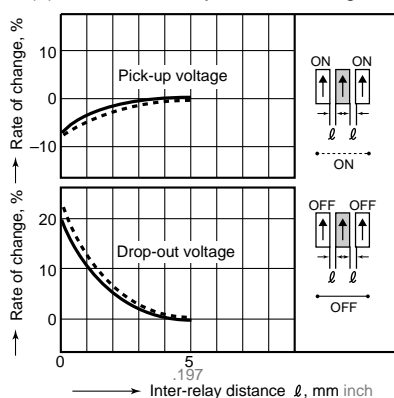

14. Actual load test  
(35 mA 48 V DC wire spring relay load)

Circuit

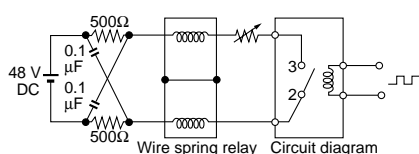

Change of pick-up and drop-out voltage

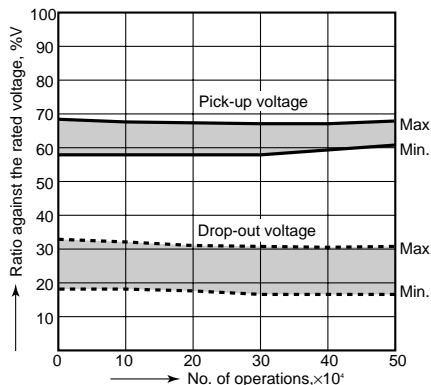

Change of contact resistance

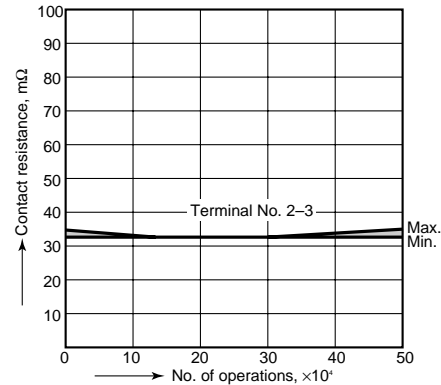

15-(1). High-frequency characteristics  
Tested sample: TN2-xxV  
Isolation characteristics

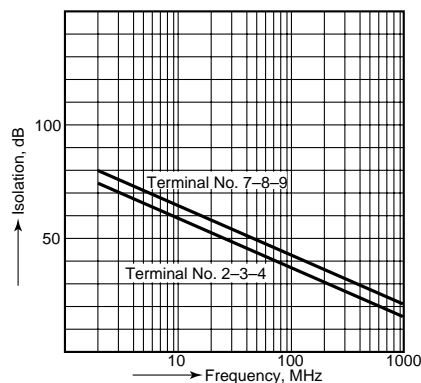

15-(2). High-frequency characteristics  
Tested sample: TN2-xxV  
Insertion loss characteristics

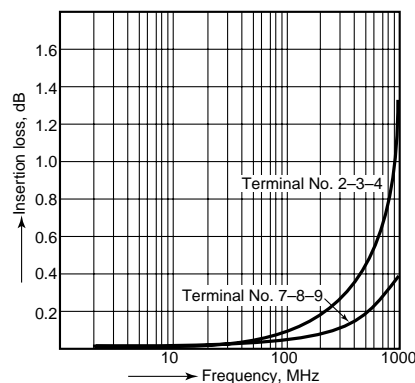

15-(3). High-frequency characteristics  
Tested sample: TN2-xxV  
V.S.W.R.

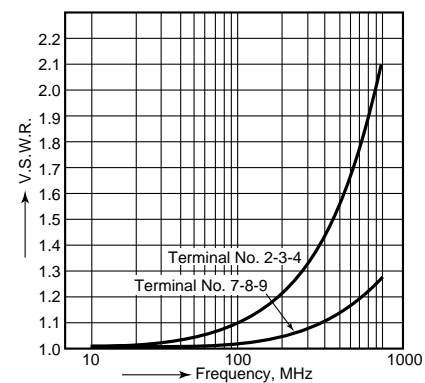

For Cautions for Use, see Page 178 and 179.