

# Chip Monolithic Ceramic Capacitors

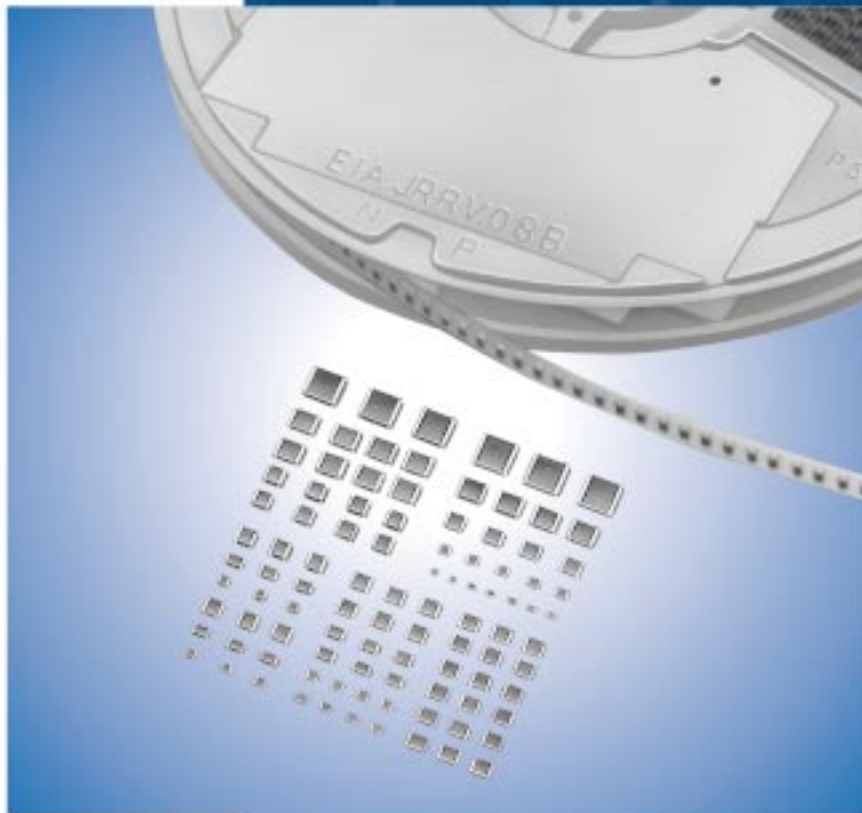

# CONTENTS

Part Numbering	2
Selection Guide	6
1 for Flow/Reflow Soldering GRM15/18/21/31 Series	7
2 for Reflow Soldering GRM32/43/55 Series	15
3 Ultra-small GRM03 Series	18
4 Thin Type (Flow/Reflow)	20
GRM Series Specifications and Test Methods	22
5 Thin Layer Large-capacitance Type	27
6 Low-dissipation Type	32
GRM Series Data	37
7 Microchips	39
8 Capacitor Arrays	42
9 for Ultrasonic Sensors	48
10 Low ESL	51
11 High Frequency for Flow/Reflow Soldering	56
12 High-Q & High Power Type	61
13 High Frequency Type	69
ERF/ERH/ERA/ERD Series Data	79
Package	81
⚠ Caution	85
Notice	91
Reference Data	97
14 Medium-voltage Low Dissipation Factor	104
15 Medium-voltage High-Capacitance for General-Use	109
16 Only for Information Devices/Tip & Ring	113
17 AC250V(r.m.s.) Type	117
18 Safety Standard Recognized Type GC (UL, IEC60384-14 Class X1/Y2)	121
19 Safety Standard Recognized Type GD (IEC60384-14 Class Y3)	122
20 Safety Standard Recognized Type GF (IEC60384-14 Class Y2)	123

<b>21</b>	<b>Safety Standard Recognized Type GB (IEC60384-14 Class X2)</b>	124
	<b>GA3 Series Specifications and Test Methods</b>	125
	<b>GRM/GR4/GA2/GA3 Series Data</b>	129
	<b>Package</b>	132
	<b>⚠ Caution</b>	135
	<b>Notice</b>	141
	<b>ISO 9000 Certifications</b>	145

- Please refer to "Specifications and Test Methods" at the end of each chapter of **5** - **17** .

- 1
- 2
- 3
- 4
- 5
- 6
- 7
- 8
- 9
- 10
- 11
- 12
- 13
- 14
- 15
- 16
- 17
- 18
- 19
- 20
- 21

● Part Numbering

Chip Monolithic Ceramic Capacitors

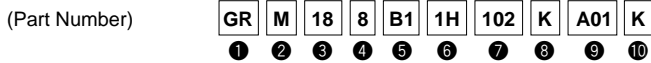

① Product ID

② Series

Product ID	Code	Series
<b>GR</b>	<b>M</b>	Tin Plated Layer
	<b>4</b>	Only for Information Devices / Tip & Ring
<b>ER</b>	<b>F</b>	High Frequency and high Power Type
	<b>H</b>	High Frequency and High Power Type (Ribbon Terminal)
	<b>A</b>	High Frequency Type
	<b>D</b>	High Frequency Type (Ribbon Terminal)
<b>GQ</b>	<b>M</b>	High Frequency for Flow/Reflow Soldering
<b>GM</b>	<b>A</b>	Monolithic Microchip
<b>GN</b>	<b>M</b>	Capacitor Array
<b>LL</b>	<b>L</b>	Low ESL Wide Width Type
<b>GJ</b>	<b>M</b>	High Frequency Low Loss Type Tin Plated Type
	<b>6</b>	High Frequency Low Loss Type
<b>GA</b>	<b>2</b>	for AC250V (r.m.s.)
	<b>3</b>	Safety Standard Recognized Type
<b>GC</b>	<b>P</b>	Automotive Soldering Electrode
	<b>M</b>	Automotive Tin Plated Layer

③ Dimension (L×W)

Code	Dimension (L×W)	EIA
<b>03</b>	0.6×0.3 mm	0201
<b>05</b>	0.5×0.5 mm	0202
<b>08</b>	0.8×0.8 mm	0303
<b>11</b>	1.25×1.0 mm	0504
<b>15</b>	1.0×0.5 mm	0402
<b>18</b>	1.6×0.8 mm	0603
<b>1D</b>	1.4×1.4 mm	
<b>1X</b>	Depends on individual standards.	
<b>21</b>	2.0×1.25 mm	0805
<b>22</b>	2.8×2.8 mm	1111
<b>31</b>	3.2×1.6 mm	1206
<b>32</b>	3.2×2.5 mm	1210
<b>3X</b>	Depends on individual standards.	
<b>42</b>	4.5×2.0 mm	1808
<b>43</b>	4.5×3.2 mm	1812
<b>52</b>	5.7×2.8 mm	2211
<b>55</b>	5.7×5.0 mm	2220

④ Dimension (T)

Code	Dimension (T)
<b>2</b>	2-elements (Array Type)
<b>3</b>	0.3 mm
<b>4</b>	4-elements (Array Type)
<b>5</b>	0.5 mm
<b>6</b>	0.6 mm
<b>7</b>	0.7 mm
<b>8</b>	0.8 mm
<b>9</b>	0.85 mm
<b>A</b>	1.0 mm
<b>B</b>	1.25 mm
<b>C</b>	1.6 mm
<b>D</b>	2.0 mm
<b>E</b>	2.5 mm
<b>F</b>	3.2 mm
<b>M</b>	1.15 mm
<b>N</b>	1.35 mm
<b>R</b>	1.8 mm
<b>S</b>	2.8 mm
<b>Q</b>	1.5 mm
<b>X</b>	Depends on individual standards.

With the array type GNM series, "Dimension(T)" indicates the number of elements.

Continued on the following page.

☐ Continued from the preceding page.

⑤ Temperature Characteristics

Code	Temperature Characteristics	Temperature Range	Capacitance Change or Temperature Coefficient	Operating Temperature Range
1X	SL	20 to 85°C	+350 to -1000ppm/°C	-55 to 125°C
2C	CH	-55 to 125°C	0±60ppm/°C	-55 to 125°C
2P	PH	-25 to 85°C	-150±60ppm/°C	-25 to 85°C
2R	RH	-25 to 85°C	-220±60ppm/°C	-25 to 85°C
2S	SH	-25 to 85°C	-330±60ppm/°C	-25 to 85°C
2T	TH	-25 to 85°C	-470±60ppm/°C	-25 to 85°C
3C	CJ	-55 to 125°C	0±120ppm/°C	-55 to 125°C
3P	PJ	-25 to 85°C	-150±120ppm/°C	-25 to 85°C
3R	RJ	-25 to 85°C	-220±120ppm/°C	-25 to 85°C
3S	SJ	-25 to 85°C	-330±120ppm/°C	-25 to 85°C
3T	TJ	-25 to 85°C	-470±120ppm/°C	-25 to 85°C
3U	UJ	-25 to 85°C	-750±120ppm/°C	-25 to 85°C
4C	CK	-55 to 125°C	0±250ppm/°C	-55 to 125°C
5C	C0G	-55 to 125°C	0±30ppm/°C	-55 to 125°C
6C	C0H/CH *1	-55 to 125°C	0±60ppm/°C	-55 to 125°C
6P	P2H	-55 to 85°C	-150±60ppm/°C	-55 to 125°C
6R	R2H	-55 to 85°C	-220±60ppm/°C	-55 to 125°C
6S	S2H	-55 to 85°C	-330±60ppm/°C	-55 to 125°C
6T	T2H	-55 to 85°C	-470±60ppm/°C	-55 to 125°C
7C	CJ *1	-55 to 125°C	0±120ppm/°C	-55 to 125°C
7U	U2J	-55 to 85°C	-750±120ppm/°C	-55 to 125°C
8C	CK *1	-55 to 125°C	0±250ppm/°C	-55 to 125°C
B1	B *2	-25 to 85°C	±10%	-25 to 85°C
B3	B	-25 to 85°C	±10%	-25 to 85°C
E4	Z5U	10 to 85°C	+22, -56%	10 to 85°C
F1	F *2	-25 to 85°C	+30, -80%	-25 to 85°C
F5	Y5V	-30 to 85°C	+22, -82%	-30 to 85°C
R1	R *2	-55 to 125°C	±15%	-55 to 125°C
R3	R	-55 to 125°C	±15%	-55 to 125°C
R6	X5R	-55 to 85°C	±15%	-55 to 85°C
R7	X7R	-55 to 125°C	±15%	-55 to 125°C
C8	X6S	-55 to 105°C	±22%	-55 to 105°C
9E	ZLM	-25 to 20°C	-4700+100/-2500ppm/°C	-25 to 85°C
		20 to 85°C	-4700+500/-1000ppm/°C	

\*1 ER series only.

\*2 Add 50% of the rated voltage.

Continued on the following page. ☐

☐ Continued from the preceding page.

⑥ Rated Voltage

Code	Rated Voltage
<b>0G</b>	DC4V
<b>0J</b>	DC6.3V
<b>1A</b>	DC10V
<b>1C</b>	DC16V
<b>1E</b>	DC25V
<b>1H</b>	DC50V
<b>2A</b>	DC100V
<b>2D</b>	DC200V
<b>2E</b>	DC250V
<b>YD</b>	DC300V
<b>2H</b>	DC500V
<b>2J</b>	DC630V
<b>3A</b>	DC1kV
<b>3D</b>	DC2kV
<b>3F</b>	DC3.15kV
<b>E2</b>	AC250V
<b>GB</b>	X2; AC250V (Safety Standard Recognized Type GB)
<b>GC</b>	X1, Y2; AC250V (Safety Standard Recognized Type GC)
<b>GD</b>	Y3; AC250V (Safety Standard Recognized Type GD)
<b>GF</b>	Y2; AC250V (Safety Standard Recognized Type GF)

⑦ Capacitance

Expressed by three figures. The unit is pico-farad (pF). The first and second figures are significant digits, and the third figure expresses the number of zeros which follow the two numbers. If there is a decimal point, it is expressed by the capital letter "R". In this case, all figures are significant digits.

Ex.)

Code	Capacitance
<b>R50</b>	0.5pF
<b>1R0</b>	1.0pF
<b>100</b>	10pF
<b>103</b>	10000pF

⑧ Capacitance Tolerance

Code	Capacitance Tolerance	TC	Series	Capacitance Step	
<b>B</b>	±0.1pF	CΔ	<b>GJM</b>	≤5pF	E24 Series, 1pF
<b>C</b>	±0.25pF	CΔ-SL	<b>GRM/ERF/ERH/ERA/ERD/GQM</b>	≤5pF	* 1pF
		CΔ	<b>GJM</b>	<10pF	E24 Series, 1pF
<b>D</b>	±0.5pF	CΔ-SL	<b>GRM</b>	6.0 to 9.0pF	* 1pF
		CΔ	<b>ERF/ERH/ERA/ERD/GQM/GJM</b>	5.1 to 9.1pF	E24 Series
<b>G</b>	±2%	CΔ	<b>GJM</b>	≥10pF	E12 Series
		CΔ	<b>GQM</b>	≥10pF	E24 Series
<b>J</b>	±5%	CΔ-SL	<b>GRM/GA3</b>	≥10pF	E12 Series
		CΔ	<b>ERF/ERH/ERA/ERD/GQM/GJM</b>	≥10pF	E24 Series
<b>K</b>	±10%	B,R,X7R,X5R,ZLM	<b>GRM/GA3</b>	E6 Series	
			<b>GR4</b>	E12 Series	
<b>M</b>	±20%	Z5U	<b>GRM</b>	E3 Series	
		B,R,X7R	<b>GMA/LLL</b>	E6 Series	
		X7R	<b>GA2</b>	E3 Series	
<b>Z</b>	+80%, -20%	F,Y5V	<b>GRM</b>	E3 Series	
<b>R</b>			Depends on individual standards.		

\* E24 series is also available.

⑨ Individual Specification Code

Code	Series	Individual Specification	Temperature Characteristics Type *4	Inner Electrode	Undercoat Metal of Outer Electrode
<b>A01</b>	<b>GRM *1</b>	Standard Type	TC	Base Metal	Base Metal
	<b>GRM *1/LLL/GNM</b>		HiK		
<b>A11</b>	<b>GRM *1</b>	Special Dimension Type (Tolerances of LXWXT are ±0.15mm)	HiK	Base Metal	Base Metal
<b>A12</b>	<b>GRM *1</b>	Special Characteristics (Applied Voltage is X1.25 of Rated Voltage at High Temperature Load Test)	HiK	Base Metal	Base Metal
<b>A35/A39</b>	<b>GRM *1</b>	Special Dimension Type	HiK	Base Metal	Base Metal

Continued on the following page. ☐

Continued from the preceding page.

Code	Series	Individual Specification	Temperature Characteristics Type *4	Inner Electrode	Undercoat Metal of Outer Electrode
<b>A61/A88/A92/A93</b>	<b>GRM *1</b>	Special Characteristics (Under special control)	HiK	Base Metal	Base Metal
<b>B01</b>	<b>GJM/GQM</b>	Standard Type	TC	Base Metal (Cu)	Base Metal
<b>C01</b>	<b>GRM *1</b>	Standard Type	HiK	Base Metal	Precious Metal
<b>C11</b>	<b>GRM *1</b>	Special Dimension Type (Tolerances of LXW are ±0.2mm, others)	HiK	Base Metal	Precious Metal
<b>C12</b>	<b>GRM *1</b>	Special Dimension Type (Length is 3.2±0.2, Width is 1.6±0.2mm, Thickness is 1.2 ±0.1mm)	HiK	Base Metal	Precious Metal
<b>D01</b>	<b>ERA/ERD/ERF/ERH</b>	Standard Type (Non-coated type for ERH series)	TC	Precious Metal	Precious Metal
	<b>GRM *1/GNM</b>		TC		
	<b>GRM *1/GMA/LLL/GNM</b>		HiK		
<b>D02</b>	<b>ERH</b>	Standard Type (Coated with Resin)	TC	Precious Metal	Precious Metal
<b>DB4</b>	<b>GJM</b>	Special Dimension Type (Thickness is 0.25±0.05mm)	TC	Precious Metal	Precious Metal
<b>E01</b>	<b>GRM *1</b>	Standard Type (Thin Layer Large Capacitance Type)	HiK	Base Metal	Base Metal
<b>E19/E34</b>	<b>GRM *1</b>	Special Characteristics (Under Special Control)	HiK	Base Metal	Base Metal
<b>E20</b>	<b>GRM *1</b>	Special Dimension Type	HiK	Base Metal	Base Metal
<b>E39</b>	<b>GRM *1</b>	Special Dimension Type	HiK	Base Metal	Base Metal
<b>V01</b>	<b>GRM *2</b>	Standard Type (New Ceramic Material)	TC	Precious Metal	Precious Metal
<b>W01</b>	<b>GRM *3/GR4/GA2/GA3</b>	Tolerance of Thickness is +0/-0.3mm	HiK	Base Metal	Base Metal
	<b>GRM *3</b>		TC		
<b>W02</b>	<b>GA3</b>	Tolerance of Thickness is ±0.2mm	HiK	Base Metal	Base Metal
<b>W03</b>	<b>GRM *3</b>	Tolerance of Thickness is ±0.2mm	HiK	Base Metal	Base Metal
<b>W07</b>	<b>GRM *3</b>	Tolerance of Thickness is ±0.1mm	HiK	Base Metal	Base Metal
<b>Y01</b>	<b>GRM *3</b>	Tolerance of Thickness is +0/-0.3mm	TC	Precious Metal	Precious Metal
	<b>GRM *3</b>		HiK		
<b>Y02</b>	<b>GA3</b>	Tolerance of Thickness is ±0.3mm	HiK	Precious Metal	Precious Metal
	<b>GRM *3/GA3</b>		TC		
<b>Y06</b>	<b>GA3</b>	Thickness is 2.7±0.3mm	HiK	Precious Metal	Precious Metal
<b>Y21</b>	<b>GRM *2</b>	Standard Type	TC	Precious Metal	Precious Metal
<b>Z01</b>	<b>GRM *1</b>	Standard Type (New Ceramic Material)	TC	Precious Metal	Precious Metal

\*1 Apply to rated voltage 100V and under. \*2 Apply to rated voltage 200/500V. \*3 Apply to rated voltage 250V, 630V to 3.15kV.

\*4 "TC" means Temperature Compensating Type and "HiK" means High Dielectric Type.

⑩Packaging

Code	Packaging
<b>L</b>	ø178mm Plastic Taping
<b>D</b>	ø178mm Paper Taping
<b>K</b>	ø330mm Plastic Taping
<b>J</b>	ø330mm Paper Taping
<b>E</b>	ø178mm Special Packaging
<b>F</b>	ø330mm Special Packaging
<b>B</b>	Bulk
<b>C</b>	Bulk Case
<b>T</b>	Bulk Tray

# Selection Guide of Chip Monolithic Ceramic Capacitors

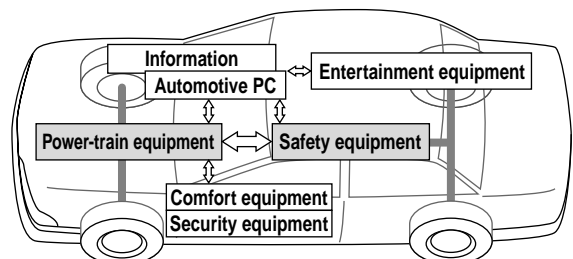
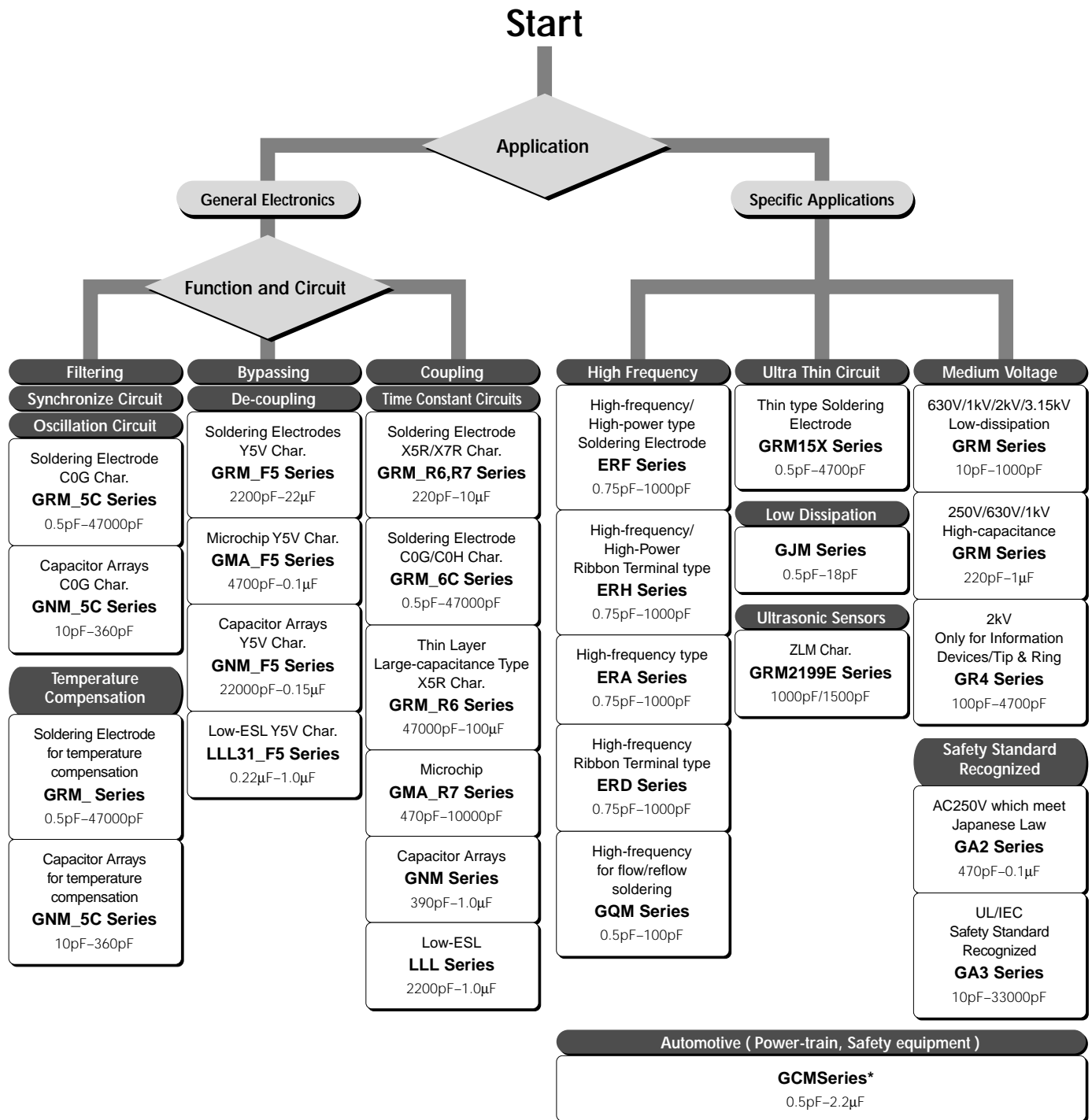

\*For other automotive equipment such as comfort, security, information, entertainment, GRM series (for general electronics) are available.



# Chip Monolithic Ceramic Capacitors



## for Flow/Reflow Soldering GRM15/18/21/31 Series

### ■ Features

1. Terminations are made of metal highly resistant to migration.
2. The GRM series is a complete line of chip ceramic capacitors in 6.3V, 10V, 16V, 25V, 50V, 100V, 200V and 500V ratings. These capacitors have temperature characteristics ranging from C0G to Y5V.
3. A wide selection of sizes is available, from the miniature LxWxT: 1.0x0.5x0.5mm to LxWxT: 3.2x1.6x1.15mm.  
GRM18, 21 and GRM31 types are suited to flow and reflow soldering.  
GRM15 type is applied to only reflow soldering.
4. Stringent dimensional tolerances allow highly reliable, high speed automatic chip placement on PCBs.
5. The GRM series is available in paper or plastic embossed tape and reel packaging for automatic placement. Bulk case packaging is also available for GRM15, GRM18 and GRM21.

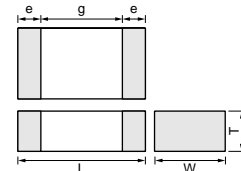

Part Number	Dimensions (mm)				
	L	W	T	e	g min.
<b>GRM155</b>	1.0 ±0.05	0.5 ±0.05	0.5 ±0.05	0.15 to 0.3	0.4
<b>GRM188*</b>	1.6 ±0.1	0.8 ±0.1	0.8 ±0.1	0.2 to 0.5	0.5
<b>GRM216</b>	2.0 ±0.1	1.25 ±0.1	0.6 ±0.1	0.2 to 0.7	0.7
<b>GRM219</b>			0.85 ±0.1		
<b>GRM21A</b>			1.0 +0/-0.2		
<b>GRM21B</b>			1.25 ±0.1		
<b>GRM316</b>	3.2 ±0.15	1.6 ±0.15	0.6 ±0.1	0.3 to 0.8	1.5
<b>GRM319</b>			0.85 ±0.1		
<b>GRM31M</b>			1.15 ±0.1		
<b>GRM31C</b>			1.6 ±0.2		

\* Bulk Case : 1.6 ±0.07(L) × 0.8 ±0.07(W) × 0.8 ±0.07(T)

### ■ Applications

General electronic equipment

## Temperature Compensating Type GRM15 Series (1.0x0.5 mm) 50V/25V

Part Number	GRM15							
L x W [EIA]	1.00x0.50 [0402]							
TC	C0G (5C)	P2H (6P)	R2H (6R)	S2H (6S)	SL (1X)		T2H (6T)	U2J (7U)
Rated Volt.	50 (1H)	50 (1H)	50 (1H)	50 (1H)	50 (1H)	25 (1E)	50 (1H)	50 (1H)
Capacitance (Capacitance part numbering code) and T (mm) Dimension (T Dimension part numbering code)								
0.50pF( <b>R50</b> )	0.50( <b>5</b> )							
0.75pF( <b>R75</b> )	0.50( <b>5</b> )							
1.0pF( <b>R10</b> )	0.50( <b>5</b> )							
2.0pF( <b>R20</b> )	0.50( <b>5</b> )							
3.0pF( <b>R30</b> )	0.50( <b>5</b> )	0.50( <b>5</b> )	0.50( <b>5</b> )	0.50( <b>5</b> )			0.50( <b>5</b> )	0.50( <b>5</b> )
4.0pF( <b>R40</b> )	0.50( <b>5</b> )	0.50( <b>5</b> )	0.50( <b>5</b> )	0.50( <b>5</b> )			0.50( <b>5</b> )	0.50( <b>5</b> )
5.0pF( <b>R50</b> )	0.50( <b>5</b> )	0.50( <b>5</b> )	0.50( <b>5</b> )	0.50( <b>5</b> )			0.50( <b>5</b> )	0.50( <b>5</b> )
6.0pF( <b>R60</b> )	0.50( <b>5</b> )	0.50( <b>5</b> )	0.50( <b>5</b> )	0.50( <b>5</b> )			0.50( <b>5</b> )	0.50( <b>5</b> )
7.0pF( <b>R70</b> )	0.50( <b>5</b> )	0.50( <b>5</b> )	0.50( <b>5</b> )	0.50( <b>5</b> )			0.50( <b>5</b> )	0.50( <b>5</b> )
8.0pF( <b>R80</b> )	0.50( <b>5</b> )	0.50( <b>5</b> )	0.50( <b>5</b> )	0.50( <b>5</b> )			0.50( <b>5</b> )	0.50( <b>5</b> )
9.0pF( <b>R90</b> )	0.50( <b>5</b> )	0.50( <b>5</b> )	0.50( <b>5</b> )	0.50( <b>5</b> )			0.50( <b>5</b> )	0.50( <b>5</b> )
10pF( <b>100</b> )	0.50( <b>5</b> )	0.50( <b>5</b> )	0.50( <b>5</b> )	0.50( <b>5</b> )			0.50( <b>5</b> )	0.50( <b>5</b> )
12pF( <b>120</b> )	0.50( <b>5</b> )	0.50( <b>5</b> )	0.50( <b>5</b> )	0.50( <b>5</b> )			0.50( <b>5</b> )	0.50( <b>5</b> )
15pF( <b>150</b> )	0.50( <b>5</b> )	0.50( <b>5</b> )	0.50( <b>5</b> )	0.50( <b>5</b> )			0.50( <b>5</b> )	0.50( <b>5</b> )
18pF( <b>180</b> )	0.50( <b>5</b> )	0.50( <b>5</b> )	0.50( <b>5</b> )	0.50( <b>5</b> )			0.50( <b>5</b> )	0.50( <b>5</b> )
22pF( <b>220</b> )	0.50( <b>5</b> )	0.50( <b>5</b> )	0.50( <b>5</b> )	0.50( <b>5</b> )			0.50( <b>5</b> )	0.50( <b>5</b> )
27pF( <b>270</b> )	0.50( <b>5</b> )	0.50( <b>5</b> )	0.50( <b>5</b> )	0.50( <b>5</b> )			0.50( <b>5</b> )	0.50( <b>5</b> )
33pF( <b>330</b> )	0.50( <b>5</b> )		0.50( <b>5</b> )	0.50( <b>5</b> )			0.50( <b>5</b> )	0.50( <b>5</b> )

Continued on the following page.

Continued from the preceding page.

1

Part Number	GRM15								
L x W [EIA]	1.00x0.50 [0402]								
TC	COG (5C)		P2H (6P)	R2H (6R)	S2H (6S)	SL (1X)		T2H (6T)	U2J (7U)
Rated Volt.	50 (1H)	50 (1H)	50 (1H)	50 (1H)	50 (1H)	50 (1H)	25 (1E)	50 (1H)	50 (1H)
Capacitance (Capacitance part numbering code) and T (mm) Dimension (T Dimension part numbering code)									
39pF(390)	0.50(5)				0.50(5)			0.50(5)	0.50(5)
47pF(470)	0.50(5)					0.50(5)		0.50(5)	0.50(5)
56pF(560)	0.50(5)					0.50(5)		0.50(5)	0.50(5)
68pF(680)	0.50(5)					0.50(5)		0.50(5)	0.50(5)
82pF(820)	0.50(5)					0.50(5)		0.50(5)	0.50(5)
100pF(101)	0.50(5)					0.50(5)		0.50(5)	0.50(5)
120pF(121)	0.50(5)					0.50(5)			0.50(5)
150pF(151)	0.50(5)					0.50(5)			0.50(5)
180pF(181)	0.50(5)					0.50(5)			0.50(5)
220pF(221)	0.50(5)						0.50(5)		
270pF(271)	0.50(5)						0.50(5)		
330pF(331)	0.50(5)						0.50(5)		
390pF(391)	0.50(5)						0.50(5)		
470pF(471)	0.50(5)								
560pF(561)	0.50(5)								
680pF(681)	0.50(5)								
820pF(821)	0.50(5)								
1000pF(102)	0.50(5)								

The part numbering code is shown in ( ).  
Dimensions are shown in mm and Rated Voltage in Vdc.

### Temperature Compensating Type GRM18 Series (1.60x0.80 mm) 200V/100V/50V/25V

Part Number	GRM18											
L x W [EIA]	1.60x0.80 [0603]											
TC	COG (5C)			P2H (6P)	R2H (6R)	S2H (6S)	SL (1X)				T2H (6T)	U2J (7U)
Rated Volt.	200 (2D)	100 (2A)	50 (1H)	50 (1H)	50 (1H)	50 (1H)	200 (2D)	100 (2A)	50 (1H)	25 (1E)	50 (1H)	50 (1H)
Capacitance (Capacitance part numbering code) and T (mm) Dimension (T Dimension part numbering code)												
0.50pF(R50)	0.80(8)	0.80(8)	0.80(8)									
0.75pF(R75)	0.80(8)	0.80(8)	0.80(8)									
1.0pF(1R0)	0.80(8)	0.80(8)	0.80(8)									
2.0pF(2R0)	0.80(8)	0.80(8)	0.80(8)									
3.0pF(3R0)	0.80(8)	0.80(8)	0.80(8)	0.80(8)	0.80(8)	0.80(8)					0.80(8)	0.80(8)
4.0pF(4R0)	0.80(8)	0.80(8)	0.80(8)	0.80(8)	0.80(8)	0.80(8)					0.80(8)	0.80(8)
5.0pF(5R0)	0.80(8)	0.80(8)	0.80(8)	0.80(8)	0.80(8)	0.80(8)					0.80(8)	0.80(8)
6.0pF(6R0)	0.80(8)	0.80(8)	0.80(8)	0.80(8)	0.80(8)	0.80(8)					0.80(8)	0.80(8)
7.0pF(7R0)	0.80(8)	0.80(8)	0.80(8)	0.80(8)	0.80(8)	0.80(8)					0.80(8)	0.80(8)
8.0pF(8R0)	0.80(8)	0.80(8)	0.80(8)	0.80(8)	0.80(8)	0.80(8)					0.80(8)	0.80(8)
9.0pF(9R0)	0.80(8)	0.80(8)	0.80(8)	0.80(8)	0.80(8)	0.80(8)					0.80(8)	0.80(8)
10pF(100)	0.80(8)	0.80(8)	0.80(8)	0.80(8)	0.80(8)	0.80(8)					0.80(8)	0.80(8)
12pF(120)		0.80(8)	0.80(8)	0.80(8)	0.80(8)	0.80(8)	0.80(8)				0.80(8)	0.80(8)
15pF(150)		0.80(8)	0.80(8)	0.80(8)	0.80(8)	0.80(8)	0.80(8)				0.80(8)	0.80(8)
18pF(180)		0.80(8)	0.80(8)	0.80(8)	0.80(8)	0.80(8)	0.80(8)				0.80(8)	0.80(8)
22pF(220)		0.80(8)	0.80(8)	0.80(8)	0.80(8)	0.80(8)	0.80(8)				0.80(8)	0.80(8)
27pF(270)		0.80(8)	0.80(8)	0.80(8)	0.80(8)	0.80(8)	0.80(8)				0.80(8)	0.80(8)
33pF(330)		0.80(8)	0.80(8)	0.80(8)	0.80(8)	0.80(8)	0.80(8)				0.80(8)	0.80(8)
39pF(390)		0.80(8)	0.80(8)	0.80(8)	0.80(8)	0.80(8)	0.80(8)				0.80(8)	0.80(8)
47pF(470)		0.80(8)	0.80(8)	0.80(8)	0.80(8)	0.80(8)	0.80(8)				0.80(8)	0.80(8)
56pF(560)		0.80(8)	0.80(8)	0.80(8)	0.80(8)	0.80(8)	0.80(8)				0.80(8)	0.80(8)

Continued on the following page. ↗

Continued from the preceding page.

Part Number	GRM18											
L x W [EIA]	1.60x0.80 [0603]											
TC	COG (5C)			P2H (6P)	R2H (6R)	S2H (6S)	SL (1X)				T2H (6T)	U2J (7U)
Rated Volt.	200 (2D)	100 (2A)	50 (1H)	50 (1H)	50 (1H)	50 (1H)	200 (2D)	100 (2A)	50 (1H)	25 (1E)	50 (1H)	50 (1H)
Capacitance (Capacitance part numbering code) and T (mm) Dimension (T Dimension part numbering code)												
68pF(680)		0.80(8)	0.80(8)	0.80(8)	0.80(8)	0.80(8)	0.80(8)		0.80(8)		0.80(8)	0.80(8)
82pF(820)		0.80(8)	0.80(8)	0.80(8)	0.80(8)	0.80(8)	0.80(8)		0.80(8)		0.80(8)	0.80(8)
100pF(101)		0.80(8)	0.80(8)	0.80(8)	0.80(8)	0.80(8)	0.80(8)		0.80(8)		0.80(8)	0.80(8)
120pF(121)		0.80(8)	0.80(8)	0.80(8)	0.80(8)	0.80(8)		0.80(8)	0.80(8)		0.80(8)	0.80(8)
150pF(151)		0.80(8)	0.80(8)	0.80(8)	0.80(8)	0.80(8)		0.80(8)	0.80(8)		0.80(8)	0.80(8)
180pF(181)		0.80(8)	0.80(8)		0.80(8)	0.80(8)		0.80(8)	0.80(8)		0.80(8)	0.80(8)
220pF(221)		0.80(8)	0.80(8)			0.80(8)		0.80(8)	0.80(8)		0.80(8)	0.80(8)
270pF(271)		0.80(8)	0.80(8)					0.80(8)	0.80(8)		0.80(8)	0.80(8)
330pF(331)		0.80(8)	0.80(8)					0.80(8)	0.80(8)		0.80(8)	0.80(8)
390pF(391)		0.80(8)	0.80(8)					0.80(8)	0.80(8)		0.80(8)	0.80(8)
470pF(471)		0.80(8)	0.80(8)						0.80(8)			0.80(8)
560pF(561)		0.80(8)	0.80(8)						0.80(8)			0.80(8)
680pF(681)			0.80(8)						0.80(8)			0.80(8)
820pF(821)			0.80(8)							0.80(8)		
1000pF(102)			0.80(8)							0.80(8)		
1200pF(122)			0.80(8)							0.80(8)		
1500pF(152)			0.80(8)							0.80(8)		
1800pF(182)			0.80(8)									
2200pF(222)			0.80(8)									
2700pF(272)			0.80(8)									

The part numbering code is shown in ( ).  
Dimensions are shown in mm and Rated Voltage in Vdc.

### Temperature Compensating Type GRM21 Series (2.00x1.25 mm) 200V/100V/50V/25V

Part Number	GRM21												
L x W [EIA]	2.00x1.25 [0805]												
TC	COG (5C)			COH (6C)	P2H (6P)	R2H (6R)	S2H (6S)	SL (1X)				T2H (6T)	U2J (7U)
Rated Volt.	200 (2D)	100 (2A)	50 (1H)	25 (1E)	50 (1H)	50 (1H)	50 (1H)	200 (2D)	100 (2A)	50 (1H)	25 (1E)	50 (1H)	50 (1H)
Capacitance (Capacitance part numbering code) and T (mm) Dimension (T Dimension part numbering code)													
12pF(120)	0.85(9)												
15pF(150)	0.85(9)												
18pF(180)	0.85(9)												
22pF(220)	0.85(9)												
27pF(270)	0.85(9)												
33pF(330)	0.85(9)												
39pF(390)	0.85(9)												
47pF(470)	0.85(9)												
56pF(560)	0.85(9)												
68pF(680)	1.25(B)	0.85(9)											
82pF(820)	1.25(B)	0.85(9)											
100pF(101)	1.25(B)	0.60(6)											
120pF(121)	1.25(B)	0.60(6)						0.85(9)					
150pF(151)	1.25(B)	0.60(6)						1.25(B)					
180pF(181)	1.25(B)	0.60(6)			0.85(9)			1.25(B)					
220pF(221)	1.25(B)	0.60(6)			0.85(9)	0.85(9)		1.25(B)					
270pF(271)	0.60(6)				0.85(9)	0.85(9)	0.85(9)	1.25(B)					
330pF(331)	0.60(6)				0.85(9)	0.85(9)	0.85(9)	1.25(B)					
390pF(391)	0.60(6)				1.25(B)	0.85(9)	0.85(9)	1.25(B)					

Continued on the following page. ↗

Continued from the preceding page.

1

Part Number	GRM21												
L x W [EIA]	2.00x1.25 [0805]												
TC	COG (5C)			COH (6C)	P2H (6P)	R2H (6R)	S2H (6S)	SL (1X)				T2H (6T)	U2J (7U)
Rated Volt.	200 (2D)	100 (2A)	50 (1H)	25 (1E)	50 (1H)	50 (1H)	50 (1H)	200 (2D)	100 (2A)	50 (1H)	25 (1E)	50 (1H)	50 (1H)
Capacitance (Capacitance part numbering code) and T (mm) Dimension (T Dimension part numbering code)													
470pF(471)		0.60(6)			1.25(B)	0.85(9)	0.85(9)	1.25(B)	0.85(9)				
560pF(561)		0.60(6)			1.25(B)	1.25(B)	1.25(B)		0.85(9)			1.25(B)	
680pF(681)		0.85(9)				1.25(B)	1.25(B)		0.85(9)			1.25(B)	
820pF(821)		0.85(9)					1.25(B)		1.25(B)	0.60(6)		1.25(B)	0.60(6)
1000pF(102)		0.85(9)							1.25(B)	0.60(6)		1.25(B)	0.60(6)
1200pF(122)									1.25(B)	0.60(6)		1.25(B)	0.60(6)
1500pF(152)									1.25(B)	0.85(9)		1.25(B)	0.85(9)
1800pF(182)			0.60(6)						1.25(B)	0.85(9)		1.25(B)	0.85(9)
2200pF(222)			0.60(6)							0.85(9)			0.85(9)
2700pF(272)			0.60(6)	1.25(B)						1.25(B)			1.25(B)
3300pF(332)			0.60(6)	1.25(B)						1.25(B)			1.25(B)
3900pF(392)			0.60(6)	1.25(B)							0.85(9)		
4700pF(472)			0.60(6)								0.85(9)		
5600pF(562)			0.85(9)								1.25(B)		
6800pF(682)			0.85(9)								1.25(B)		
8200pF(822)			0.85(9)										
10000pF(103)			0.85(9)							0.60(6)			0.60(6)
12000pF(123)										0.60(6)			0.60(6)
15000pF(153)										0.60(6)			0.60(6)
18000pF(183)										0.60(6)			0.60(6)
22000pF(223)										0.85(9)			0.85(9)
27000pF(273)										0.85(9)			0.85(9)
33000pF(333)										1.00(A)			1.00(A)
39000pF(393)										1.25(B)			1.25(B)
47000pF(473)										1.25(B)			1.25(B)

The part numbering code is shown in ( ).  
Dimensions are shown in mm and Rated Voltage in Vdc.

**Temperature Compensating Type GRM31 Series (3.20x1.60 mm) 500V/200V/100V/50V/25V**

Part Number	GRM31													
L x W [EIA]	3.20x1.60 [1206]													
TC	COG (5C)				COH (6C)	P2H (6P)	R2H (6R)	S2H (6S)	SL (1X)				T2H (6T)	U2J (7U)
Rated Volt.	500 (2H)	200 (2D)	50 (1H)	25 (1E)	25 (1E)	50 (1H)	50 (1H)	50 (1H)	200 (2D)	100 (2A)	50 (1H)	25 (1E)	50 (1H)	50 (1H)
Capacitance (Capacitance part numbering code) and T (mm) Dimension (T Dimension part numbering code)														
1.0pF(1R0)	1.15(M)													
2.0pF(2R0)	1.15(M)													
3.0pF(3R0)	1.15(M)													
4.0pF(4R0)	1.15(M)													
5.0pF(5R0)	1.15(M)													
6.0pF(6R0)	1.15(M)													
7.0pF(7R0)	1.15(M)													
8.0pF(8R0)	1.15(M)													
9.0pF(9R0)	1.15(M)													
10pF(100)	1.15(M)													
12pF(120)	1.15(M)													
15pF(150)	1.15(M)													
18pF(180)	1.15(M)													
22pF(220)	1.15(M)													

Continued on the following page. ↗

Continued from the preceding page.

Part Number	GRM31													
L x W [EIA]	3.20x1.60 [1206]													
TC	COG (5C)				C0H (6C)	P2H (6P)	R2H (6R)	S2H (6S)	SL (1X)				T2H (6T)	U2J (7U)
Rated Volt.	500 (2H)	200 (2D)	50 (1H)	25 (1E)	25 (1E)	50 (1H)	50 (1H)	50 (1H)	200 (2D)	100 (2A)	50 (1H)	25 (1E)	50 (1H)	50 (1H)
Capacitance (Capacitance part numbering code) and T (mm) Dimension (T Dimension part numbering code)														
27pF(270)	1.15(M)													
33pF(330)	1.15(M)													
39pF(390)	1.15(M)													
47pF(470)	1.15(M)													
56pF(560)	1.15(M)													
68pF(680)	1.15(M)													
82pF(820)	1.15(M)													
270pF(271)		1.15(M)												
330pF(331)		1.15(M)												
390pF(391)		1.15(M)												
470pF(471)		1.15(M)												
560pF(561)									1.15(M)					
680pF(681)						0.85(9)			1.15(M)					
820pF(821)						0.85(9)	0.85(9)		1.15(M)					
1000pF(102)						1.15(M)	1.15(M)	0.85(9)	1.15(M)					
1200pF(122)						1.15(M)	1.15(M)	1.15(M)	1.15(M)					
1500pF(152)						1.15(M)	1.15(M)	1.15(M)						
1800pF(182)								1.15(M)						
2200pF(222)									1.15(M)				1.15(M)	
2700pF(272)									1.15(M)				1.15(M)	
3300pF(332)									1.15(M)				1.15(M)	
3900pF(392)									1.15(M)	0.85(9)			1.15(M)	0.85(9)
4700pF(472)									1.15(M)	0.85(9)				0.85(9)
5600pF(562)			0.85(9)							0.85(9)				0.85(9)
6800pF(682)			0.85(9)		0.85(9)					1.15(M)				1.15(M)
8200pF(822)			0.85(9)		1.15(M)					1.15(M)				1.15(M)
10000pF(103)			0.85(9)									1.15(M)		
12000pF(123)												1.15(M)		
15000pF(153)												1.15(M)		
27000pF(273)			0.85(9)											
33000pF(333)			0.85(9)											
47000pF(473)			1.15(M)											
56000pF(563)											0.85(9)			0.85(9)
68000pF(683)											1.15(M)			1.15(M)
82000pF(823)											1.15(M)			1.15(M)
0.10μF(104)				1.60(C)							1.15(M)			1.15(M)

The part numbering code is shown in ( ).  
Dimensions are shown in mm and Rated Voltage in Vdc.

### High Dielectric Constant Type X5R (R6) Characteristics

TC	X5R (R6)							
Part Number	GRM15		GRM18		GRM21		GRM31	
L x W [EIA]	1.00x0.50 [0402]		1.60x0.80 [0603]		2.00x1.25 [0805]		3.20x1.60 [1206]	
Rated Volt.	16 (1C)	10 (1A)	10 (1A)	6.3 (0J)	10 (1A)	6.3 (0J)	10 (1A)	6.3 (0J)
Capacitance (Capacitance part numbering code) and T (mm) Dimension (T Dimension part numbering code)								
68000pF(683)		0.50(5)						
0.10μF(104)	0.50(5)	0.50(5)						
0.33μF(334)			0.80(8)					

Continued on the following page. ↗

Continued from the preceding page.

1

TC	X5R (R6)							
Part Number	GRM15		GRM18		GRM21		GRM31	
L x W [EIA]	1.00x0.50 [0402]		1.60x0.80 [0603]		2.00x1.25 [0805]		3.20x1.60 [1206]	
Rated Volt.	16 (1C)	10 (1A)	10 (1A)	6.3 (0J)	10 (1A)	6.3 (0J)	10 (1A)	6.3 (0J)
Capacitance (Capacitance part numbering code) and T (mm) Dimension (T Dimension part numbering code)								
0.47μF(474)			0.80(8)					
0.68μF(684)			0.80(8)					
1.0μF(105)			0.80(8)	0.80(8)	0.85(9)			
1.5μF(155)						0.85(9)		
2.2μF(225)					1.25(B)	1.25(B)	0.85(9)	
3.3μF(335)						1.25(B)	1.30(X)	
4.7μF(475)						1.25(B)	1.60(C)	1.15(M)
10μF(106)							1.60(C)	1.60(C)

The part numbering code is shown in each ( ).

3.3μF and 4.7μF, 6.3V rated are GRM21 series of L: 2±0.15, W: 1.25±0.15, T: 1.25±0.15.

T: 1.15±0.1mm is also available for GRM31 1.0μF for 16V.

L: 3.2±0.2, W: 1.6±0.2 for GRM31 16V 1.0μF type. Also L: 3.2±0.2, W: 1.6±0.2, T: 1.15±0.15 for GRM31 16V 1.5μF and 2.2μF type.

Dimensions are shown in mm and Rated Voltage in Vdc.

### High Dielectric Constant Type X7R (R7) Characteristics

TC	X7R (R7)																	
Part Number	GRM15				GRM18				GRM21				GRM31					
L x W [EIA]	1.00x0.50 [0402]				1.60x0.80 [0603]				2.00x1.25 [0805]				3.20x1.60 [1206]					
Rated Volt.	50 (1H)	25 (1E)	16 (1C)	10 (1A)	100 (2A)	50 (1H)	25 (1E)	16 (1C)	10 (1A)	100 (2A)	50 (1H)	25 (1E)	16 (1C)	100 (2A)	50 (1H)	25 (1E)	16 (1C)	10 (1A)
Capacitance (Capacitance part numbering code) and T (mm) Dimension (T Dimension part numbering code)																		
220pF (221)	0.50 (5)					0.80 (8)												
330pF (331)	0.50 (5)					0.80 (8)												
470pF (471)	0.50 (5)					0.80 (8)												
680pF (681)	0.50 (5)					0.80 (8)												
1000pF (102)	0.50 (5)					0.80 (8)												
1500pF (152)	0.50 (5)					0.80 (8)												
2200pF (222)	0.50 (5)				0.80 (8)	0.80 (8)												
3300pF (332)	0.50 (5)				0.80 (8)	0.80 (8)												
4700pF (472)	0.50 (5)					0.80 (8)				0.85 (9)								
6800pF (682)		0.50 (5)				0.80 (8)				0.85 (9)								
10000pF (103)		0.50 (5)				0.80 (8)				1.25 (B)								
15000pF (153)			0.50 (5)			0.80 (8)												
22000pF (223)			0.50 (5)			0.80 (8)												
33000pF (333)				0.50 (5)		0.80 (8)	0.80 (8)				0.85 (9)			1.15 (M)				

Continued on the following page. ↗

Continued from the preceding page.

TC	X7R (R7)																	
Part Number	GRM15				GRM18					GRM21				GRM31				
L x W [EIA]	1.00x0.50 [0402]				1.60x0.80 [0603]					2.00x1.25 [0805]				3.20x1.60 [1206]				
Rated Volt.	50 (1H)	25 (1E)	16 (1C)	10 (1A)	100 (2A)	50 (1H)	25 (1E)	16 (1C)	10 (1A)	100 (2A)	50 (1H)	25 (1E)	16 (1C)	100 (2A)	50 (1H)	25 (1E)	16 (1C)	10 (1A)
Capacitance (Capacitance part numbering code) and T (mm) Dimension (T Dimension part numbering code)																		
47000pF (473)				0.50 (5)		0.80 (8)	0.80 (8)				1.25 (B)			1.15 (M)				
68000pF (683)						0.80 (8)	0.80 (8)				1.25 (B)							
0.10μF (104)			0.50 (5)	0.50 (5)		0.80 (8)	0.80 (8)	0.80 (8)			1.25 (B)	1.25 (B)						
0.15μF (154)							0.80 (8)		0.80 (8)		1.25 (B)	1.25 (B)						
0.22μF (224)								0.80 (8)	0.80 (8)		1.25 (B)	0.85 (9)						
0.33μF (334)											0.85 (9)	1.25 (B)			0.85 (9)			
0.47μF (474)											1.25 (B)	1.25 (B)	0.85 (9)		1.15 (M)			
0.68μF (684)													0.85 (9)			0.85 (9)		
1.0μF (105)													1.25 (B)		1.15 (M)	1.15 (M)	0.85 (9)	0.85 (9)
1.5μF (155)															1.60 (C)		1.15 (M)	
2.2μF (225)															1.60 (C)		1.15 (M)	0.85 (9)
3.3μF (335)																1.60 (C)		
4.7μF (475)																1.60 (C)		

The part numbering code is shown in each ( ).

The tolerance will be changed to L: 3.2±0.2, W: 1.6±0.2 for GRM31 16V 1.0μF type. Also L: 3.2±0.2, W: 1.6±0.2, T: 1.15±0.15 for GRM31 16V 1.5μF and 2.2μF type.

Dimensions are shown in mm and Rated Voltage in Vdc.

### High Dielectric Constant Type Y5V (F5) Characteristics

TC	Y5V (F5)																	
Part Number	GRM15				GRM18					GRM21				GRM31				
L x W [EIA]	1.00x0.50 [0402]				1.60x0.80 [0603]					2.00x1.25 [0805]				3.20x1.60 [1206]				
Rated Volt.	50 (1H)	25 (1E)	16 (1C)	100 (2A)	50 (1H)	25 (1E)	16 (1C)	10 (1A)	50 (1H)	25 (1E)	16 (1C)	10 (1A)	50 (1H)	25 (1E)	16 (1C)	10 (1A)	6.3 (0J)	
Capacitance (Capacitance part numbering code) and T (mm) Dimension (T Dimension part numbering code)																		
2200pF (222)	0.50 (5)																	
4700pF (472)	0.50 (5)			0.80 (8)														
10000pF (103)	0.50 (5)				0.80 (8)													
22000pF (223)		0.50 (5)			0.80 (8)													
47000pF (473)			0.50 (5)		0.80 (8)													
0.10μF (104)		0.50 (5)	0.50 (5)		0.80 (8)	0.80 (8)				0.85 (9)								

Continued on the following page.

Continued from the preceding page.

TC	Y5V (F5)																	
Part Number	GRM15			GRM18					GRM21				GRM31					
L x W [EIA]	1.00x0.50 [0402]			1.60x0.80 [0603]					2.00x1.25 [0805]				3.20x1.60 [1206]					
Rated Volt.	50 (1H)	25 (1E)	16 (1C)	100 (2A)	50 (1H)	25 (1E)	16 (1C)	10 (1A)	50 (1H)	25 (1E)	16 (1C)	10 (1A)	50 (1H)	25 (1E)	16 (1C)	10 (1A)	6.3 (0J)	
Capacitance (Capacitance part numbering code) and T (mm) Dimension (T Dimension part numbering code)																		
0.22μF (224)								0.80 (8)		1.25 (B)	0.85 (9)							
0.47μF (474)								0.80 (8)	0.80 (8)		1.25 (B)			1.15 (M)				
1.0μF (105)								0.80 (8)	0.80 (8)		0.85 (9)	0.85 (9)	0.85 (9)		1.15 (M)	0.85 (9)		
2.2μF (225)											1.25 (B)	1.25 (B)	1.25 (B)			1.15 (M)	0.85 (9)	
4.7μF (475)													1.25 (B)		1.15 (M)	1.15 (M)	1.15 (M)	
10μF (106)															1.60 (C)		1.15 (M)	1.15 (M)

The part numbering code is shown in each ( ).  
T: 1.25±0.1mm is also available for GRM21 25V or 16V 1.0μF type.  
Dimensions are shown in mm and Rated Voltage in Vdc.

### High Dielectric Constant Type Z5U (E4) Characteristics

TC	Z5U (E4)					
Part Number	GRM18		GRM21		GRM31	
L x W [EIA]	1.60x0.80 [0603]		2.00x1.25 [0805]		3.20x1.60 [1206]	
Rated Volt.	50 (1H)		50 (1H)		50 (1H)	
Capacitance (Capacitance part numbering code) and T (mm) Dimension (T Dimension part numbering code)						
10000pF(103)	0.80(8)					
22000pF(223)	0.80(8)					
47000pF(473)			0.60(6)			
0.10μF(104)			0.85(9)			
0.22μF(224)					0.85(9)	

The part numbering code is shown in ( ).  
Dimensions are shown in mm and Rated Voltage in Vdc.



# Chip Monolithic Ceramic Capacitors



## for Reflow Soldering GRM32/43/55 Series

### ■ Features

1. Terminations are made of metal highly resistant to migration.
2. The GRM series is a complete line of chip ceramic capacitors in 10V, 16V, 25V, 50V, 100V and 200V ratings.  
These capacitors have temperature characteristics ranging from C0G to Y5V.
3. This series consists of type LxWxT: 3.2x2.5x0.85mm to LxWxT: 5.7x5.0x2.5mm. These are suited to only reflow soldering.
4. Stringent dimensional tolerances allow highly reliable, high speed automatic chip placement on PCBs.
5. The GRM series is available in paper or plastic embossed tape and reel packaging for automatic placement.

Part Number	Dimensions (mm)				
	L	W	T	e min.	g min.
GRM329	3.2 ±0.3	2.5 ±0.2	0.85 ±0.1	0.3	1.0
GRM32M			1.15 ±0.1		
GRM32N			1.35 ±0.15		
GRM32R			1.8 ±0.2		
GRM32E			2.5 ±0.2		
GRM43M	4.5 ±0.4	3.2 ±0.3	1.15 ±0.1	0.3	2.0
GRM43N			1.35 ±0.15		
GRM43R			1.8 ±0.2		
GRM43D			2.0 ±0.2		
GRM43E			2.5 ±0.2		
GRM55M	5.7 ±0.4	5.0 ±0.4	1.15 ±0.1	0.3	2.0
GRM55N			1.35 ±0.15		
GRM55C			1.6 ±0.2		
GRM55R			1.8 ±0.2		
GRM55D			2.0 ±0.2		
GRM55E	2.5 ±0.2				

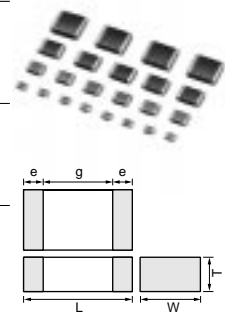

### ■ Applications

General electronic equipment

## Temperature Compensating Type GRM32/43/55 Series

Part Number	TC Code (Standard)	Rated Voltage (Vdc)	Capacitance (pF)	Length L (mm)	Width W (mm)	Thickness T (mm)
GRM32N5C2D561JV01	C0G (EIA)	200	560 ±5%	3.20	2.50	1.35
GRM32N5C2D681JY21	C0G (EIA)	200	680 ±5%	3.20	2.50	1.35
GRM32N5C2D821JY21	C0G (EIA)	200	820 ±5%	3.20	2.50	1.35
GRM32N5C2D102JY21	C0G (EIA)	200	1000 ±5%	3.20	2.50	1.35
GRM43R5C2D122JV01	C0G (EIA)	200	1200 ±5%	4.50	3.20	1.80
GRM43R5C2D152JV01	C0G (EIA)	200	1500 ±5%	4.50	3.20	1.80
GRM43R5C2D182JY21	C0G (EIA)	200	1800 ±5%	4.50	3.20	1.80
GRM43R5C2D222JY21	C0G (EIA)	200	2200 ±5%	4.50	3.20	1.80
GRM43R5C2D272JY21	C0G (EIA)	200	2700 ±5%	4.50	3.20	1.80
GRM55N5C2D332JY21	C0G (EIA)	200	3300 ±5%	5.70	5.00	1.35
GRM55R5C2D392JY21	C0G (EIA)	200	3900 ±5%	5.70	5.00	1.80
GRM55R5C2D472JY21	C0G (EIA)	200	4700 ±5%	5.70	5.00	1.80
GRM55R5C2D562JY21	C0G (EIA)	200	5600 ±5%	5.70	5.00	1.80
GRM32N1X2D152JV01	SL (JIS)	200	1500 ±5%	3.20	2.50	1.35
GRM43N1X2D182JV01	SL (JIS)	200	1800 ±5%	4.50	3.20	1.35
GRM43N1X2D222JV01	SL (JIS)	200	2200 ±5%	4.50	3.20	1.35
GRM43R1X2D272JV01	SL (JIS)	200	2700 ±5%	4.50	3.20	1.80
GRM43R1X2D332JV01	SL (JIS)	200	3300 ±5%	4.50	3.20	1.80
GRM43R1X2D392JV01	SL (JIS)	200	3900 ±5%	4.50	3.20	1.80
GRM55N1X2D472JV01	SL (JIS)	200	4700 ±5%	5.70	5.00	1.35
GRM55R1X2D562JV01	SL (JIS)	200	5600 ±5%	5.70	5.00	1.80
GRM55R1X2D682JV01	SL (JIS)	200	6800 ±5%	5.70	5.00	1.80
GRM55R1X2D822JV01	SL (JIS)	200	8200 ±5%	5.70	5.00	1.80
GRM32N1X2A562JZ01	SL (JIS)	100	5600 ±5%	3.20	2.50	1.35
GRM32N1X2A682JZ01	SL (JIS)	100	6800 ±5%	3.20	2.50	1.35
GRM43N1X2A822JZ01	SL (JIS)	100	8200 ±5%	4.50	3.20	1.35
GRM43R1X2A103JZ01	SL (JIS)	100	10000 ±5%	4.50	3.20	1.80

Continued on the following page.

Continued from the preceding page.

Part Number	TC Code (Standard)	Rated Voltage (Vdc)	Capacitance (pF)	Length L (mm)	Width W (mm)	Thickness T (mm)
GRM43R1X2A123JZ01	SL (JIS)	100	12000 ±5%	4.50	3.20	1.80
GRM43R1X2A153JZ01	SL (JIS)	100	15000 ±5%	4.50	3.20	1.80
GRM55M1X2A183JZ01	SL (JIS)	100	18000 ±5%	5.70	5.00	1.15
GRM55N1X2A223JZ01	SL (JIS)	100	22000 ±5%	5.70	5.00	1.35
GRM55R1X2A273JZ01	SL (JIS)	100	27000 ±5%	5.70	5.00	1.80
GRM55R1X2A333JZ01	SL (JIS)	100	33000 ±5%	5.70	5.00	1.80
GRM55R1X2A393JZ01	SL (JIS)	100	39000 ±5%	5.70	5.00	1.80
GRM32N1X1H103JZ01	SL (JIS)	50	10000 ±5%	3.20	2.50	1.35
GRM32N1X1H123JZ01	SL (JIS)	50	12000 ±5%	3.20	2.50	1.35
GRM43R1X1H153JZ01	SL (JIS)	50	15000 ±5%	4.50	3.20	1.80
GRM55M1X1H183JZ01	SL (JIS)	50	18000 ±5%	5.70	5.00	1.15
GRM55N1X1H223JZ01	SL (JIS)	50	22000 ±5%	5.70	5.00	1.35
GRM55R1X1H273JZ01	SL (JIS)	50	27000 ±5%	5.70	5.00	1.80
GRM55R1X1H333JZ01	SL (JIS)	50	33000 ±5%	5.70	5.00	1.80
GRM55R1X1H393JZ01	SL (JIS)	50	39000 ±5%	5.70	5.00	1.80

### High Dielectric Constant Type Type GRM32 Series (3.20x2.50mm)

Part Number	TC Code (Standard)	Rated Voltage (Vdc)	Capacitance	Length L (mm)	Width W (mm)	Thickness T (mm)
GRM32ER61A106KC01	X5R (EIA)	10	10μF ±10%	3.20	2.50	2.50
GRM32NR72A683KA01	X7R (EIA)	100	68000pF ±10%	3.20	2.50	1.35
GRM32NR72A104KA01	X7R (EIA)	100	0.10μF ±10%	3.20	2.50	1.35
GRM32ER72A105KA01	X7R (EIA)	100	1.0μF ±10%	3.20	2.50	2.50
GRM32NR71H684KA01	X7R (EIA)	50	0.68μF ±10%	3.20	2.50	1.35
GRM32RR71H105KA01	X7R (EIA)	50	1.0μF ±10%	3.20	2.50	1.80
GRM32RR71E225KC01	X7R (EIA)	25	2.2μF ±10%	3.20	2.50	1.80
GRM32MR71C225KC01	X7R (EIA)	16	2.2μF ±10%	3.20	2.50	1.15
GRM32NR71C335KC01	X7R (EIA)	16	3.3μF ±10%	3.20	2.50	1.35
GRM32RR71C475KC01	X7R (EIA)	16	4.7μF ±10%	3.20	2.50	1.80
GRM32ER71H475KA88	X7R (EIA)	16	4.7μF ±10%	3.20	2.50	2.50
GRM32NF52A104ZA01	Y5V (EIA)	100	0.10μF +80/-20%	3.20	2.50	1.35
GRM32RF51H105ZA01	Y5V (EIA)	50	1.0μF +80/-20%	3.20	2.50	1.8
GRM32DF51H106ZA01	Y5V (EIA)	50	10μF +80/-20%	3.20	2.50	2.00
GRM329F51E475ZA01	Y5V (EIA)	25	4.7μF +80/-20%	3.20	2.50	0.85
GRM32NF51E106ZA01	Y5V (EIA)	25	10μF +80/-20%	3.20	2.50	1.35
GRM32NF51C106ZA01	Y5V (EIA)	16	10μF +80/-20%	3.20	2.50	1.35

### High Dielectric Constant Type Type GRM43 Series (4.50x3.20mm)

Part Number	TC Code (Standard)	Rated Voltage (Vdc)	Capacitance (μF)	Length L (mm)	Width W (mm)	Thickness T (mm)
GRM43RR72A154KA01	X7R (EIA)	100	0.15 ±10%	4.50	3.20	1.80
GRM43RR72A224KA01	X7R (EIA)	100	0.22 ±10%	4.50	3.20	1.80
GRM43DR72A474KA01	X7R (EIA)	100	0.47 ±10%	4.50	3.20	2.00
GRM43ER72A225KA01	X7R (EIA)	100	2.2 ±10%	4.50	3.20	2.50
GRM43ER71H225KA01	X7R (EIA)	50	2.2 ±10%	4.50	3.20	2.50

### High Dielectric Constant Type Type GRM55 Series (5.70x5.00mm)

Part Number	TC Code (Standard)	Rated Voltage (Vdc)	Capacitance (μF)	Length L (mm)	Width W (mm)	Thickness T (mm)
<b>GRM55DR61H106KA01</b>	X5R (EIA)	50	10.0 ±10%	5.70	5.00	2.00
<b>GRM55DR72A105KA01</b>	X7R (EIA)	100	1.0 ±10%	5.70	5.00	2.00
<b>GRM55ER72A475KA01</b>	X7R (EIA)	100	4.7 ±10%	5.70	5.00	2.50
<b>GRM55RR71H105KA01</b>	X7R (EIA)	50	1.0 ±10%	5.70	5.00	1.80
<b>GRM55RR71H155KA01</b>	X7R (EIA)	50	1.5 ±10%	5.70	5.00	1.80
<b>GRM55ER71H475KA01</b>	X7R (EIA)	50	4.7 ±10%	5.70	5.00	2.50
<b>GRM55RF52A474ZA01</b>	Y5V (EIA)	100	0.47 +80/-20%	5.70	5.00	1.80

# Chip Monolithic Ceramic Capacitors



## Ultra-small GRM03 Series

3

### ■ Features

1. Small chip size (LxWxT: 0.6x0.3x0.3mm).
2. Terminations are made of metal highly resistant to migration.
3. GRM03 type is suited to only reflow soldering.
4. Stringent dimensional tolerances allow highly reliable, high speed automatic chip placement on PCBs.
5. GRM03 series are suited to miniature micro wave module, portable equipment and high frequency circuits.

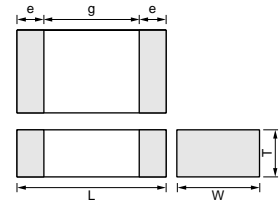

Part Number	Dimensions (mm)				
	L	W	T	e	g min.
<b>GRM033</b>	0.6 ±0.03	0.3 ±0.03	0.3 ±0.03	0.1 to 0.2	0.2

### ■ Applications

1. Miniature micro wave module
2. Portable equipment
3. High frequency circuit

Part Number	<b>GRM03</b>				
L x W	0.6x0.3				
TC	C0G (5C)	X5R (R6)	X7R (R7)		Y5V (F5)
Rated Volt.	25 (1E)	10 (1A)	16 (1C)	6.3 (0J)	10 (1A)
Capacitance (Capacitance part numbering code) and T (mm) Dimension (T Dimension part numbering code)					
0.50pF(50)	0.3(3)				
1.0pF(10)	0.3(3)				
2.0pF(20)	0.3(3)				
3.0pF(30)	0.3(3)				
4.0pF(40)	0.3(3)				
5.0pF(50)	0.3(3)				
6.0pF(60)	0.3(3)				
7.0pF(70)	0.3(3)				
8.0pF(80)	0.3(3)				
9.0pF(90)	0.3(3)				
10pF(100)	0.3(3)				
12pF(120)	0.3(3)				
15pF(150)	0.3(3)				
18pF(180)	0.3(3)				
22pF(220)	0.3(3)				
27pF(270)	0.3(3)				
33pF(330)	0.3(3)				
39pF(390)	0.3(3)				
47pF(470)	0.3(3)				
56pF(560)	0.3(3)				
68pF(680)	0.3(3)				
82pF(820)	0.3(3)				
100pF(101)	0.3(3)		0.3(3)		
150pF(151)			0.3(3)		
220pF(221)			0.3(3)		
330pF(331)			0.3(3)		
470pF(471)			0.3(3)		
680pF(681)			0.3(3)		

Continued on the following page.

☐ Continued from the preceding page.

Part Number	GRM03				
L x W	0.6x0.3				
TC	C0G (5C)	X5R (R6)	X7R (R7)		Y5V (F5)
Rated Volt.	25 (1E)	10 (1A)	16 (1C)	6.3 (0J)	10 (1A)
Capacitance (Capacitance part numbering code) and T (mm) Dimension (T Dimension part numbering code)					
1000pF(102)			0.3(3)		
1500pF(152)		0.3(3)		0.3(3)	
2200pF(222)		0.3(3)		0.3(3)	0.3(3)
3300pF(332)		0.3(3)		0.3(3)	
4700pF(472)		0.3(3)		0.3(3)	0.3(3)
6800pF(682)		0.3(3)		0.3(3)	
10000pF(103)		0.3(3)		0.3(3)	0.3(3)

The part numbering code is shown in ( ).

Dimensions are shown in mm and Rated Voltage in Vdc.

3

# Chip Monolithic Ceramic Capacitors



## Thin Type (Flow/Reflow)

### ■ Features

1. This series is suited to flow and reflow soldering. Capacitor terminations are made of metal highly resistant to migration.
2. Large capacitance values enable excellent bypass effects to be realized.
3. Its thin package makes this series ideally suited for the production of small electronic products and for mounting underneath ICs.

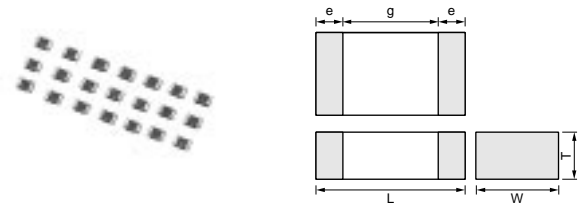

Part Number	Dimensions (mm)				
	L	W	T	e	g min.
<b>GRM15X</b>	1.0 ±0.05	0.5 ±0.05	0.25 ±0.05	0.1 to 0.3	0.4

### ■ Applications

Thin equipment such as IC cards

## Temperature Compensating Type

Part Number	TC Code (Standard)	Rated Voltage (Vdc)	Capacitance (pF)	Length L (mm)	Width W (mm)	Thickness T (mm)
<b>GRM15X5C1H1R0CDB4</b>	COG (EIA)	50	1.0 ±0.25pF	1.00	0.50	0.25
<b>GRM15X5C1H2R0CDB4</b>	COG (EIA)	50	2.0 ±0.25pF	1.00	0.50	0.25
<b>GRM15X5C1H3R0CDB4</b>	COG (EIA)	50	3.0 ±0.25pF	1.00	0.50	0.25
<b>GRM15X5C1H4R0CDB4</b>	COG (EIA)	50	4.0 ±0.25pF	1.00	0.50	0.25
<b>GRM15X5C1H5R0CDB4</b>	COG (EIA)	50	5.0 ±0.25pF	1.00	0.50	0.25
<b>GRM15X5C1H6R0DDB4</b>	COG (EIA)	50	6.0 ±0.5pF	1.00	0.50	0.25
<b>GRM15X5C1H7R0DDB4</b>	COG (EIA)	50	7.0 ±0.5pF	1.00	0.50	0.25
<b>GRM15X5C1H8R0DDB4</b>	COG (EIA)	50	8.0 ±0.5pF	1.00	0.50	0.25
<b>GRM15X5C1H9R0DDB4</b>	COG (EIA)	50	9.0 ±0.5pF	1.00	0.50	0.25
<b>GRM15X5C1H100JDB4</b>	COG (EIA)	50	10 ±5%	1.00	0.50	0.25
<b>GRM15X5C1H120JDB4</b>	COG (EIA)	50	12 ±5%	1.00	0.50	0.25
<b>GRM15X5C1H150JDB4</b>	COG (EIA)	50	15 ±5%	1.00	0.50	0.25
<b>GRM15X5C1H180JDB4</b>	COG (EIA)	50	18 ±5%	1.00	0.50	0.25
<b>GRM15X5C1H220JDB4</b>	COG (EIA)	50	22 ±5%	1.00	0.50	0.25
<b>GRM15X5C1H270JDB4</b>	COG (EIA)	50	27 ±5%	1.00	0.50	0.25
<b>GRM15X5C1H330JDB4</b>	COG (EIA)	50	33 ±5%	1.00	0.50	0.25
<b>GRM15X5C1H390JDB4</b>	COG (EIA)	50	39 ±5%	1.00	0.50	0.25
<b>GRM15X5C1H470JDB4</b>	COG (EIA)	50	47 ±5%	1.00	0.50	0.25
<b>GRM15X5C1H560JDB4</b>	COG (EIA)	50	56 ±5%	1.00	0.50	0.25
<b>GRM15X5C1H680JDB4</b>	COG (EIA)	50	68 ±5%	1.00	0.50	0.25
<b>GRM15X5C1H820JDB4</b>	COG (EIA)	50	82 ±5%	1.00	0.50	0.25
<b>GRM15X5C1H101JDB4</b>	COG (EIA)	50	100 ±5%	1.00	0.50	0.25
<b>GRM15X5C1E121JDB4</b>	COG (EIA)	25	120 ±5%	1.00	0.50	0.25
<b>GRM15X5C1E151JDB4</b>	COG (EIA)	25	150 ±5%	1.00	0.50	0.25
<b>GRM15X5C1E181JDB4</b>	COG (EIA)	25	180 ±5%	1.00	0.50	0.25
<b>GRM15X5C1E221JDB4</b>	COG (EIA)	25	220 ±5%	1.00	0.50	0.25

## High Dielectric Constant Type

Part Number	TC Code (Standard)	Rated Voltage (Vdc)	Capacitance (pF)	Length L (mm)	Width W (mm)	Thickness T (mm)
<b>GRM15XR71H221KA86</b>	X7R (EIA)	50	220 ±10%	1.00	0.50	0.25
<b>GRM15XR71H331KA86</b>	X7R (EIA)	50	330 ±10%	1.00	0.50	0.25
<b>GRM15XR71H471KA86</b>	X7R (EIA)	50	470 ±10%	1.00	0.50	0.25

Continued on the following page.

Continued from the preceding page.

Part Number	TC Code (Standard)	Rated Voltage (Vdc)	Capacitance (pF)	Length L (mm)	Width W (mm)	Thickness T (mm)
<b>GRM15XR71H681KA86</b>	X7R (EIA)	50	680 ±10%	1.00	0.50	0.25
<b>GRM15XR71H102KA86</b>	X7R (EIA)	50	1000 ±10%	1.00	0.50	0.25
<b>GRM15XR71H152KA86</b>	X7R (EIA)	50	1500 ±10%	1.00	0.50	0.25
<b>GRM15XR71E182KA86</b>	X7R (EIA)	25	1800 ±10%	1.00	0.50	0.25
<b>GRM15XR71E222KA86</b>	X7R (EIA)	25	2200 ±10%	1.00	0.50	0.25
<b>GRM15XR71C332KA86</b>	X7R (EIA)	16	3300 ±10%	1.00	0.50	0.25
<b>GRM15XR71C472KA86</b>	X7R (EIA)	16	4700 ±10%	1.00	0.50	0.25
<b>GRM15XR71C682KA86</b>	X7R (EIA)	16	6800 ±10%	1.00	0.50	0.25

4

## GRM Series Specifications and Test Methods

No.	Item	Specifications		Test Method																								
		Temperature Compensating Type	High Dielectric Type																									
1	Operating Temperature	-55 to +125°C	R6 : -55 to +85°C R7 : -55 to +125°C E4 : +10 to +85°C F5 : -30 to +85°C																									
2	Rated Voltage	See the previous page.		The rated voltage is defined as the maximum voltage which may be applied continuously to the capacitor. When AC voltage is superimposed on DC voltage, V <sup>P-P</sup> or V <sup>O-P</sup> , whichever is larger, should be maintained within the rated voltage range.																								
3	Appearance	No defects or abnormalities		Visual inspection																								
4	Dimensions	Within the specified dimensions		Using calipers on micrometer																								
5	Dielectric Strength	No defects or abnormalities		No failure should be observed when *300% of the rated voltage (C0Δ to U2J and SL) or *250% of the rated voltage (X5R, X7R, Z5U and Y5V) is applied between the terminations for 1 to 5 seconds, provided the charge/discharge current is less than 50mA. *200% for 500V																								
6	Insulation Resistance	More than 10,000MΩ or 500Ω • F (Whichever is smaller)		The insulation resistance should be measured with a DC voltage not exceeding the rated voltage at 25°C and 75%RH max. and within 2 minutes of charging.																								
7	Capacitance	Within the specified tolerance		The capacitance/Q/D.F. should be measured at 25°C at the frequency and voltage shown in the table.																								
8	Q/ Dissipation Factor (D.F.)	30pFmin. : Q ≥ 1000 30pFmax. : Q ≥ 400+20C C : Nominal Capacitance (pF)	[R6, R7] W.V. : 25Vmin. : 0.025max. W.V. : 16/10V : 0.035max. W.V. : 6.3V 0.05max.(C<3.3μF) 0.1max.(C≥3.3μF)	<table border="1"> <thead> <tr> <th>Item</th> <th>Char.</th> <th>Frequency</th> <th>Voltage</th> </tr> </thead> <tbody> <tr> <td>ΔC to 7U, 1X (1000pF and below)</td> <td></td> <td>1±0.1MHz</td> <td>0.5 to 5Vrms</td> </tr> <tr> <td>ΔC to 7U, 1X (more than 1000pF)</td> <td></td> <td>1±0.1kHz</td> <td>1±0.2Vrms</td> </tr> <tr> <td>R6, R7, F5 (10μF and below)</td> <td></td> <td>1±0.1kHz</td> <td>1±0.2Vrms</td> </tr> <tr> <td>R6, R7, F5 (more than 10μF)</td> <td></td> <td>120±24Hz</td> <td>0.5±0.1Vrms</td> </tr> <tr> <td>E4</td> <td></td> <td>1±0.1kHz</td> <td>0.5±0.05Vrms</td> </tr> </tbody> </table>	Item	Char.	Frequency	Voltage	ΔC to 7U, 1X (1000pF and below)		1±0.1MHz	0.5 to 5Vrms	ΔC to 7U, 1X (more than 1000pF)		1±0.1kHz	1±0.2Vrms	R6, R7, F5 (10μF and below)		1±0.1kHz	1±0.2Vrms	R6, R7, F5 (more than 10μF)		120±24Hz	0.5±0.1Vrms	E4		1±0.1kHz	0.5±0.05Vrms
			Item	Char.	Frequency	Voltage																						
ΔC to 7U, 1X (1000pF and below)		1±0.1MHz	0.5 to 5Vrms																									
ΔC to 7U, 1X (more than 1000pF)		1±0.1kHz	1±0.2Vrms																									
R6, R7, F5 (10μF and below)		1±0.1kHz	1±0.2Vrms																									
R6, R7, F5 (more than 10μF)		120±24Hz	0.5±0.1Vrms																									
E4		1±0.1kHz	0.5±0.05Vrms																									
[E4] W.V. : 25Vmin. : 0.025max.																												
[F5] W.V. : 25Vmin. : 0.05max.(C<0.10μF) : 0.09max.(C≥0.10μF) W.V. : 16V/10V : 0.125max. W.V. : 6.3Vmax. : 0.15max.																												
9	Capacitance Temperature Characteristics	Capacitance Change	Within the specified tolerance (Table A)	<p>The capacitance change should be measured after 5 min. at each specified temperature stage.</p> <p>(1) Temperature Compensating Type The temperature coefficient is determined using the Capacitance measured in step 3 as a reference. When cycling the temperature sequentially from step 1 through 5 (C0Δ : +25°C to +125°C ; other temp. coeffs. : +25°C to +85°C) the capacitance should be within the specified tolerance for the temperature coefficient and capacitance change as Table A.</p> <p>The capacitance drift is calculated by dividing the differences between the maximum and minimum measured values in steps 1, 3 and 5 by the capacitance value in step 3.</p> <table border="1"> <thead> <tr> <th>Step</th> <th>Temperature(°C)</th> </tr> </thead> <tbody> <tr> <td>1</td> <td>25±2</td> </tr> <tr> <td>2</td> <td>-55±3 (for ΔC to 7U/1X/R6/R7) -30±3 (for F5) 10±3 (for E4)</td> </tr> <tr> <td>3</td> <td>25±2</td> </tr> <tr> <td>4</td> <td>125±3 (for ΔC/R7) 85±3 (for other TC)</td> </tr> <tr> <td>5</td> <td>25±2</td> </tr> </tbody> </table> <p>(2) High Dielectric Constant Type The ranges of capacitance change compared with the above 25°C value over the temperature ranges shown in the table should be within the specified ranges.</p>	Step	Temperature(°C)	1	25±2	2	-55±3 (for ΔC to 7U/1X/R6/R7) -30±3 (for F5) 10±3 (for E4)	3	25±2	4	125±3 (for ΔC/R7) 85±3 (for other TC)	5	25±2												
		Step	Temperature(°C)																									
		1	25±2																									
2	-55±3 (for ΔC to 7U/1X/R6/R7) -30±3 (for F5) 10±3 (for E4)																											
3	25±2																											
4	125±3 (for ΔC/R7) 85±3 (for other TC)																											
5	25±2																											
Temperature Coefficient	Within the specified tolerance (Table A)	—																										
Capacitance Drift	Within ±0.2% or ±0.05pF (Whichever is larger.) *Does not apply to 1X/25V	—																										

Continued on the following page. 



## GRM Series Specifications and Test Methods

Continued from the preceding page.

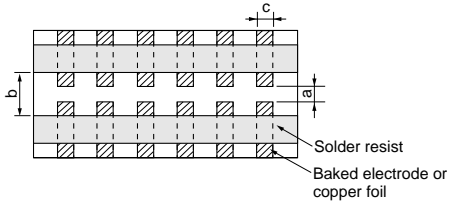
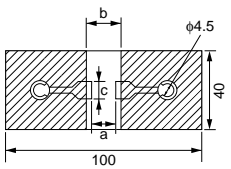
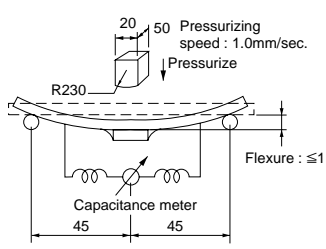
No.	Item	Specifications		Test Method																																				
		Temperature Compensating Type	High Dielectric Type																																					
10	Adhesive Strength of Termination	No removal of the terminations or other defect should occur.		<p>Solder the capacitor to the test jig (glass epoxy board) shown in Fig. 1 using a eutectic solder. Then apply 10N* force in parallel with the test jig for 10±1sec. The soldering should be done either with an iron or using the reflow method and should be conducted with care so that the soldering is uniform and free of defects such as heat shock. *2N (GR□03) 5N (GR□15, GRM18)</p>  <table border="1" style="margin-left: auto; margin-right: auto;"> <thead> <tr> <th>Type</th> <th>a</th> <th>b</th> <th>c</th> </tr> </thead> <tbody> <tr><td>GR□03</td><td>0.3</td><td>0.9</td><td>0.3</td></tr> <tr><td>GR□15</td><td>0.4</td><td>1.5</td><td>0.5</td></tr> <tr><td>GRM18</td><td>1.0</td><td>3.0</td><td>1.2</td></tr> <tr><td>GRM21</td><td>1.2</td><td>4.0</td><td>1.65</td></tr> <tr><td>GRM31</td><td>2.2</td><td>5.0</td><td>2.0</td></tr> <tr><td>GRM32</td><td>2.2</td><td>5.0</td><td>2.9</td></tr> <tr><td>GRM43</td><td>3.5</td><td>7.0</td><td>3.7</td></tr> <tr><td>GRM55</td><td>4.5</td><td>8.0</td><td>5.6</td></tr> </tbody> </table> <p style="text-align: right;">(in mm)</p>	Type	a	b	c	GR□03	0.3	0.9	0.3	GR□15	0.4	1.5	0.5	GRM18	1.0	3.0	1.2	GRM21	1.2	4.0	1.65	GRM31	2.2	5.0	2.0	GRM32	2.2	5.0	2.9	GRM43	3.5	7.0	3.7	GRM55	4.5	8.0	5.6
		Type	a		b	c																																		
GR□03	0.3	0.9	0.3																																					
GR□15	0.4	1.5	0.5																																					
GRM18	1.0	3.0	1.2																																					
GRM21	1.2	4.0	1.65																																					
GRM31	2.2	5.0	2.0																																					
GRM32	2.2	5.0	2.9																																					
GRM43	3.5	7.0	3.7																																					
GRM55	4.5	8.0	5.6																																					
Fig. 1																																								
11	Appearance	No defects or abnormalities		<p>Solder the capacitor to the test jig (glass epoxy board) in the same manner and under the same conditions as (10). The capacitor should be subjected to a simple harmonic motion having a total amplitude of 1.5mm, the frequency being varied uniformly between the approximate limits of 10 and 55Hz. The frequency range, from 10 to 55Hz and return to 10Hz, should be traversed in approximately 1 minute. This motion should be applied for a period of 2 hours in each of 3 mutually perpendicular directions (total of 6 hours).</p>																																				
	Capacitance	Within the specified tolerance																																						
11	Vibration Resistance	Q/D.F.	<p>30pFmin. : <math>Q \geq 1000</math>                      30pFmax. : <math>Q \geq 400+20C</math>                      C : Nominal Capacitance (pF)</p>	<p>[R6, R7]                      W.V. : 25Vmin. : 0.025max.                      W.V. : 16/10V : 0.035max.                      W.V. : 6.3V :                      0.05max. (C&lt;3.3μF)                      0.1max. (C≥3.3μF)</p> <p>[E4]                      W.V. : 25Vmin. : 0.025max.</p> <p>[F5]                      W.V. : 25Vmin.                      : 0.05max. (C&lt;0.10μF)                      : 0.09max. (C≥0.10μF)</p> <p>W.V. : 16V/10V : 0.125max.                      W.V. : 6.3Vmax. : 0.15max.</p>																																				
			No crack or marked defect should occur.																																					
12	Deflection	No crack or marked defect should occur.		<p>Solder the capacitor on the test jig (glass epoxy board) shown in Fig. 2 using a eutectic solder. Then apply a force in the direction shown in Fig. 3. The soldering should be done either with an iron or using the reflow method and should be conducted with care so that the soldering is uniform and free of defects such as heat shock.</p>  <table border="1" style="margin-left: auto; margin-right: auto;"> <thead> <tr> <th>Type</th> <th>a</th> <th>b</th> <th>c</th> </tr> </thead> <tbody> <tr><td>GR□03</td><td>0.3</td><td>0.9</td><td>0.3</td></tr> <tr><td>GR□15</td><td>0.4</td><td>1.5</td><td>0.5</td></tr> <tr><td>GRM18</td><td>1.0</td><td>3.0</td><td>1.2</td></tr> <tr><td>GRM21</td><td>1.2</td><td>4.0</td><td>1.65</td></tr> <tr><td>GRM31</td><td>2.2</td><td>5.0</td><td>2.0</td></tr> <tr><td>GRM32</td><td>2.2</td><td>5.0</td><td>2.9</td></tr> <tr><td>GRM43</td><td>3.5</td><td>7.0</td><td>3.7</td></tr> <tr><td>GRM55</td><td>4.5</td><td>8.0</td><td>5.6</td></tr> </tbody> </table> <p style="text-align: right;">(in mm)</p>	Type	a	b	c	GR□03	0.3	0.9	0.3	GR□15	0.4	1.5	0.5	GRM18	1.0	3.0	1.2	GRM21	1.2	4.0	1.65	GRM31	2.2	5.0	2.0	GRM32	2.2	5.0	2.9	GRM43	3.5	7.0	3.7	GRM55	4.5	8.0	5.6
		Type	a		b	c																																		
GR□03	0.3	0.9	0.3																																					
GR□15	0.4	1.5	0.5																																					
GRM18	1.0	3.0	1.2																																					
GRM21	1.2	4.0	1.65																																					
GRM31	2.2	5.0	2.0																																					
GRM32	2.2	5.0	2.9																																					
GRM43	3.5	7.0	3.7																																					
GRM55	4.5	8.0	5.6																																					
Fig. 2				 <p style="text-align: center;">Fig. 3</p>																																				

Continued on the following page. ↗

## GRM Series Specifications and Test Methods

Continued from the preceding page.

No.	Item	Specifications		Test Method	
		Temperature Compensating Type	High Dielectric Type		
13	Solderability of Termination	75% of the terminations are to be soldered evenly and continuously.		Immerse the capacitor in a solution of ethanol (JIS-K-8101) and rosin (JIS-K-5902) (25% rosin in weight proportion). Preheat at 80 to 120°C for 10 to 30 seconds. After preheating, immerse in eutectic solder solution for 2±0.5 seconds at 230±5°C.	
14	Resistance to Soldering Heat	The measured and observed characteristics should satisfy the specifications in the following table.		Preheat the capacitor at 120 to 150°C for 1 minute. Immerse the capacitor in a eutectic solder solution at 270±5°C for 10±0.5 seconds. Let sit at room temperature for 24±2 hours (temperature compensating type) or 48±4 hours (high dielectric constant type), then measure.  •Initial measurement for high dielectric constant type Perform a heat treatment at 150 ± <sub>1</sub> 8°C for one hour and then let sit for 48±4 hours at room temperature. Perform the initial measurement.  *Preheating for GRM32/43/55	
		Appearance	No marking defects		
		Capacitance Change	Within ±2.5% or ±0.25pF (Whichever is larger)		R6, R7 : Within ±7.5% E4, F5 : Within ±20%
		Q/D.F.	30pFmin. : Q≥1000 30pFmax. : Q≥400+20C C : Nominal Capacitance (pF)		[R6, R7] W.V. : 25Vmin. : 0.025max. W.V. : 16/10V : 0.035max. W.V. : 6.3V : 0.05max. (C<3.3μF) 0.1max. (C≥3.3μF)  [E4] W.V. : 25Vmin. : 0.025max.  [F5] W.V. : 25Vmin. : 0.05max. (C<0.10μF) : 0.09max. (C≥0.10μF) W.V. : 16V/10V : 0.125max. W.V. : 6.3Vmax. : 0.15max.
		I.R.	More than 10,000MΩ or 500Ω • F (Whichever is smaller)		
	Dielectric Strength	No failure			
15	Temperature Cycle	The measured and observed characteristics should satisfy the specifications in the following table.		Fix the capacitor to the supporting jig in the same manner and under the same conditions as (10). Perform the five cycles according to the four heat treatments listed in the following table. Let sit for 24±2 hours (temperature compensating type) or 48±4 hour (high dielectric constant type) at room temperature, then measure.	
		Appearance	No marking defects		
		Capacitance Change	Within ±2.5% or ±0.25pF (Whichever is larger)		R6, R7 : Within ±7.5% E4, F5 : Within ±20%
		Q/D.F.	30pFmin. : Q≥1000 30pFmax. : Q≥400+20C C : Nominal Capacitance (pF)		[R6, R7] W.V. : 25Vmin. : 0.025max. W.V. : 16/10V : 0.035max. W.V. : 6.3V : 0.05max. (C<3.3μF) 0.1max. (C≥3.3μF)  [E4] W.V. : 25Vmin. : 0.025max.  [F5] W.V. : 25Vmin. : 0.05max. (C<0.10μF) : 0.09max. (C≥0.10μF) W.V. : 16V/10V : 0.125max. W.V. : 6.3Vmax. : 0.15max.
		I.R.	More than 10,000MΩ or 500Ω • F (Whichever is smaller)		
	Dielectric Strength	No failure			

Step	Temperature	Time
1	100°C to 120°C	1 min.
2	170°C to 200°C	1 min.

Step	1	2	3	4
Temp. (°C)	Min. Operating Temp. +0/-3	Room Temp.	Max. Operating Temp. +3/-0	Room Temp.
Time (min.)	30±3	2 to 3	30±3	2 to 3

Continued on the following page. ↗

## GRM Series Specifications and Test Methods

Continued from the preceding page.

No.	Item	Specifications		Test Method	
		Temperature Compensating Type	High Dielectric Type		
16	Humidity Steady State	The measured and observed characteristics should satisfy the specifications in the following table.		Let the capacitor sit at 40±2°C and 90 to 95% humidity for 500±12 hours. Remove and let sit for 24±2 hours (temperature compensating type) or 48±4 hours (high dielectric constant type) at room temperature, then measure.	
		Appearance	No marking defects		
		Capacitance Change	Within ±5% or ±0.5pF (Whichever is larger)		R6, R7 : Within ±12.5% E4, F5 : Within ±30%
		Q/D.F.	30pF and over : $Q \geq 350$ 10pF and over 30pF and below : $Q \geq 275 + 5C/2$ 10pF and below : $Q \geq 200 + 10C$ C : Nominal Capacitance (pF)		[R6, R7] W.V. : 25Vmin. : 0.05max. W.V. : 16/10V : 0.05max. W.V. : 6.3V 0.075max. (C<3.3μF) 0.125max. (C≥3.3μF) [E4] W.V. : 25Vmin. : 0.05max. [F5] W.V. : 25Vmin. : 0.075max. (C<0.10μF) : 0.125max. (C≥0.10μF) W.V. : 16V/10V : 0.15max. W.V. : 6.3Vmax. : 0.2max.
		I.R.	More than 1,000MΩ or 50Ω • F (Whichever is smaller)		
		Dielectric Strength	No failure		
17	Humidity Load	The measured and observed characteristics should satisfy the specifications in the following table.		Apply the rated voltage at 40±2°C and 90 to 95% humidity for 500±12 hours. Remove and let sit for 24±2 hours (temperature compensating type) or 48±4 hours (high dielectric constant type) at room temperature, then measure. The charge/discharge current is less than 50mA.  •Initial measurement for F5/10V max. Apply the rated DC voltage for 1 hour at 40±2°C. Remove and let sit for 48±4 hours at room temperature. Perform initial measurement.	
		Appearance	No marking defects		
		Capacitance Change	Within ±7.5% or ±0.75pF (Whichever is larger)		R6, R7 : Within ±12.5% E4 : Within ±30% F5 : Within ±30% [W.V. : 10Vmax.] F5 : Within +30/-40%
		Q/D.F.	30pF and over : $Q \geq 200$ 30pF and below : $Q \geq 100 + 10C/3$ C : Nominal Capacitance (pF)		[R6, R7] W.V. : 25Vmin. : 0.05max. W.V. : 16/10V : 0.05max. W.V. : 6.3V 0.075max. (C<3.3μF) 0.125max. (C≥3.3μF) [E4] W.V. : 25Vmin. : 0.05max. [F5] W.V. : 25Vmin. : 0.075max. (C<0.10μF) : 0.125max. (C≥0.10μF) W.V. : 16V/10V : 0.15max. W.V. : 6.3Vmax. : 0.2max.
		I.R.	More than 500MΩ or 25Ω • F (Whichever is smaller)		
		Dielectric Strength	No failure		

Continued on the following page.

## GRM Series Specifications and Test Methods

Continued from the preceding page.

No.	Item	Specifications		Test Method	
		Temperature Compensating Type	High Dielectric Type		
18	High Temperature Load	The measured and observed characteristics should satisfy the specifications in the following table.			Apply 200% of the rated voltage for 1000±12 hours at the maximum operating temperature ±3°C. Let sit for 24±2 hours (temperature compensating type) or 48±4 hours (high dielectric constant type) at room temperature, then measure. The charge/discharge current is less than 50mA. •Initial measurement for high dielectric constant type. Apply 200% of the rated DC voltage for one hour at the maximum operating temperature ±3°C. Remove and let sit for 48±4 hours at room temperature. Perform initial measurement.  *150% for 500V and C≥10μF
		Appearance	No marking defects		
		Capacitance Change	Within ±3% or ±0.3pF (Whichever is larger)	R6, R7 : Within ±12.5% E4 : Within ±30% F5 : Within ±30% (Cap<1.0μF) F5 : Within +30/-40% (Cap≥1.0μF)	
		Q/D.F.	30pF and over : Q≥350 10pF and over 30pF and below : Q≥275+5C/2 10pF and below : Q≥200+10C C : Nominal Capacitance (pF)	[R6, R7] W.V. : 25Vmin. : 0.05max. W.V. : 16/10V : 0.05max. W.V. : 6.3V : 0.075max. (C<3.3μF) 0.125max. (C≥3.3μF) [E4] W.V. : 25Vmin. : 0.05max [F5] W.V. : 25Vmin. : 0.075max. (C<0.10μF) 0.125max. (C≥0.10μF) W.V. : 16V/10V : 0.15max. W.V. : 6.3Vmax. : 0.2max.	
		I.R.	More than 1,000MΩ or 50Ω•F (Whichever is smaller)		
	Dielectric Strength	No failure			

Table A

Char. Code	Nominal Values (ppm/°C)*	Capacitance Change from 25°C (%)					
		-55		-30		-10	
		Max.	Min.	Max.	Min.	Max.	Min.
5C	0 ± 30	0.58	-0.24	0.40	-0.17	0.25	-0.11
6C	0 ± 60	0.87	-0.48	0.59	-0.33	0.38	-0.21
6P	-150 ± 60	2.33	0.72	1.61	0.50	1.02	0.32
6R	-220 ± 60	3.02	1.28	2.08	0.88	1.32	0.56
6S	-330 ± 60	4.09	2.16	2.81	1.49	1.79	0.95
6T	-470 ± 60	5.46	3.28	3.75	2.26	2.39	1.44
7U	-750 ± 120	8.78	5.04	6.04	3.47	3.84	2.21
1X	+350 to -1000	-	-	-	-	-	-

\*Nominal values denote the temperature coefficient within a range of 25°C to 125°C (for ΔC)/85°C (for other TC).

# Chip Monolithic Ceramic Capacitors



## Thin Layer Large-capacitance Type

### ■ Features

1. Smaller size and higher capacitance value.
2. High reliability and no polarity.
3. Excellent pulse responsibility and noise reduction due to the low impedance at high frequency.

### ■ Applications

General electronic equipment

Part Number	Dimensions (mm)				
	L	W	T	e min.	g min.
GRM033	0.6 ±0.03	0.3 ±0.03	0.3 ±0.03	0.1 to 0.2	0.2
GRM155	1.0 ±0.05	0.5 ±0.05	0.5 ±0.05	0.15 to 0.3	0.4
GRM185	1.6 ±0.1	0.8 ±0.1	0.5 ±0.05	0.2 to 0.5	0.5
GRM188	1.6 ±0.1	0.8 ±0.1	0.8 ±0.1	0.2 to 0.5	0.5
GRM216	2.0 ±0.1	1.25 ±0.1	0.6 ±0.1	0.2 to 0.7	0.7
GRM219			0.85 ±0.1		
GRM21B			1.25 ±0.1		
GRM316	3.2 ±0.15	1.6 ±0.15	0.6 ±0.1	0.3 to 0.8	1.5
GRM319			0.85 ±0.1		
GRM31M			1.6 ±0.2		
GRM31C	3.2 ±0.2	1.6 ±0.2	1.15 ±0.1	0.3 to 0.8	1.5
GRM32D	3.2 ±0.3	2.5 ±0.2	2.0 ±0.2	0.3	1.0
GRM32E			2.5 ±0.2		
GRM43D			2.0 ±0.2		
GRM43E	4.5 ±0.4	3.2 ±0.3	2.5 ±0.2	0.3	2.0
GRM43S			2.8 ±0.2		
GRM55F	5.7 ±0.4	5.0 ±0.4	3.2 ±0.2	0.3	2.0

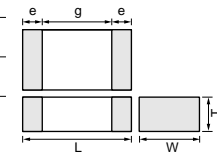

5

Part Number	TC Code (Standard)	Rated Voltage (Vdc)	Capacitance	Length L (mm)	Width W (mm)	Thickness T (mm)
GRM188R61C105KE93	X5R (EIA)	16	1.0μF ±10%	1.60	0.80	0.80
GRM219R61C225KA88	X5R (EIA)	16	2.2μF ±10%	2.00	1.25	0.85
GRM319R61C475KA88	X5R (EIA)	16	4.7μF ±10%	3.20	1.60	0.85
GRM32ER61C226KE20	X5R (EIA)	16	22μF ±10%	3.20	2.50	2.50
GRM185R61A105KE36	X5R (EIA)	10	1.0μF ±10%	1.60	0.80	0.50
GRM155R61A154KE19	X5R (EIA)	10	1.5μF ±10%	1.00	0.50	0.50
GRM155R61A224KE19	X5R (EIA)	10	2.2μF ±10%	1.00	0.50	0.50
GRM188R61A225KE34	X5R (EIA)	10	2.2μF ±10%	1.60	0.80	0.80
GRM188R61A225ME34	X5R (EIA)	10	2.2μF ±10%	1.60	0.80	0.80
GRM216R61A225KE24	X5R (EIA)	10	2.2μF ±10%	2.00	1.25	0.60
GRM219R61A225KA01	X5R (EIA)	10	2.2μF ±10%	2.00	1.25	0.85
GRM219R61A335KE19	X5R (EIA)	10	3.3μF ±10%	2.00	1.25	0.85
GRM316R61A335KE19	X5R (EIA)	10	3.3μF ±10%	3.20	1.60	0.60
GRM219R61A475KE19	X5R (EIA)	10	4.7μF ±10%	2.00	1.25	0.85
GRM219R61A475KE34	X5R (EIA)	10	4.7μF ±10%	2.00	1.25	0.85
GRM316R61A475KE19	X5R (EIA)	10	4.7μF ±10%	3.20	1.60	0.60
GRM319R61A475KA01	X5R (EIA)	10	4.7μF ±10%	3.20	1.60	0.85
GRM31MR61A106KE19	X5R (EIA)	10	10μF ±10%	3.20	1.60	1.15
GRM033R60J153KE01	X5R (EIA)	6.3	15000pF ±10%	0.6	0.3	0.3
GRM033R60J223KE01	X5R (EIA)	6.3	22000pF ±10%	0.6	0.3	0.3
GRM033R60J333KE01	X5R (EIA)	6.3	33000pF ±10%	0.6	0.3	0.3
GRM033R60J393KE19	X5R (EIA)	6.3	39000pF ±10%	0.6	0.3	0.3
GRM033R60J473KE19	X5R (EIA)	6.3	47000pF ±10%	0.6	0.3	0.3
GRM033R60J104KE19	X5R (EIA)	6.3	0.10μF ±10%	0.6	0.3	0.3
GRM155R60J154KE01	X5R (EIA)	6.3	0.15μF ±10%	1.00	0.50	0.50
GRM155R60J224KE01	X5R (EIA)	6.3	0.22μF ±10%	1.00	0.50	0.50
GRM155R60J334KE01	X5R (EIA)	6.3	0.33μF ±10%	1.00	0.50	0.50
GRM155R60J474KE19	X5R (EIA)	6.3	0.47μF ±10%	1.00	0.50	0.50
GRM155R60J105KE19	X5R (EIA)	6.3	1.0μF ±10%	1.00	0.50	0.50
GRM185R60J105KE21	X5R (EIA)	6.3	1.0μF ±10%	1.60	0.80	0.50
GRM185R60J105KE26	X5R (EIA)	6.3	1.0μF ±10%	1.60	0.80	0.50
GRM185R60J225KE26	X5R (EIA)	6.3	2.2μF ±10%	1.60	0.80	0.50
GRM188R60J225KE01	X5R (EIA)	6.3	2.2μF ±10%	1.60	0.80	0.80
GRM188R60J225KE19	X5R (EIA)	6.3	2.2μF ±10%	1.60	0.80	0.80
GRM188R60J475KE19	X5R (EIA)	6.3	4.7μF ±10%	1.60	0.80	0.80
GRM219R60J475KE01	X5R (EIA)	6.3	4.7μF ±10%	2.00	1.25	0.85
GRM219R60J106KE19	X5R (EIA)	6.3	10μF ±10%	2.00	1.25	0.85
GRM219R60J106ME19	X5R (EIA)	6.3	10μF ±20%	2.00	1.25	0.85

Continued on the following page.

Continued from the preceding page.

Part Number	TC Code (Standard)	Rated Voltage (Vdc)	Capacitance	Length L (mm)	Width W (mm)	Thickness T (mm)
<b>GRM21BR60J106KE01</b>	X5R (EIA)	6.3	10μF ±10%	2.00	1.25	1.25
<b>GRM21BR60J106KE19</b>	X5R (EIA)	6.3	10μF ±10%	2.00	1.25	1.25
<b>GRM21BR60J106ME01</b>	X5R (EIA)	6.3	10μF ±20%	2.00	1.25	1.25
<b>GRM21BR60J106ME19</b>	X5R (EIA)	6.3	10μF +10/-20%	2.00	1.25	1.25
<b>GRM21BR60J226ME39</b>	X5R (EIA)	6.3	22μF ±20%	2.00	1.25	1.25
<b>GRM31CR60J226ME19</b>	X5R (EIA)	6.3	22μF ±20%	3.20	1.60	1.60
<b>GRM32DR60J226KA01</b>	X5R (EIA)	6.3	22μF ±10%	3.20	2.50	2.00
<b>GRM32DR60J336ME19</b>	X5R (EIA)	6.3	33μF ±10%	3.20	2.50	2.00
<b>GRM32ER60J476ME20</b>	X5R (EIA)	6.3	47μF ±20%	3.20	2.50	2.50
<b>GRM32ER60J107ME20</b>	X5R (EIA)	6.3	100μF ±20%	3.20	2.50	2.50
<b>GRM43SR60J107ME20</b>	X5R (EIA)	6.3	100μF ±20%	4.50	3.20	2.80
<b>GRM32ER71A226KE20</b>	X7R (EIA)	10	22μF ±10%	3.20	2.50	2.50
<b>GRM32ER71A226ME20</b>	X7R (EIA)	10	22μF ±20%	3.20	2.50	2.50
<b>GRM188F51A225ZE01</b>	Y5V (EIA)	10	2.2μF +80/-20%	1.60	0.80	0.80
<b>GRM188F50J225ZE01</b>	Y5V (EIA)	6.3	2.2μF +80/-20%	1.60	0.80	0.80
<b>GRM21BF50J106ZE01</b>	Y5V (EIA)	6.3	10μF +80/-20%	2.00	1.25	1.25

## Specifications and Test Methods

5

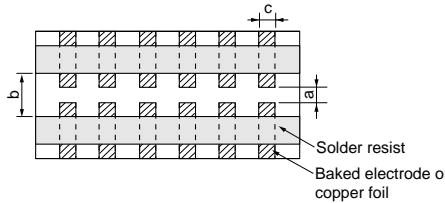
No.	Item	Specifications	Test Method																																				
1	Operating Temperature Range	R6 : -55°C to +85°C R7 : -55°C to +125°C F5 : -30°C to +85°C C8 : -55°C to +105°C																																					
2	Rated Voltage	See the previous pages.	The rated voltage is defined as the maximum voltage which may be applied continuously to the capacitor. When AC voltage is superimposed on DC voltage, V <sup>P-P</sup> or V <sup>O-P</sup> , whichever is larger, should be maintained within the rated voltage range.																																				
3	Appearance	No defects or abnormalities	Visual inspection																																				
4	Dimensions	Within the specified dimension	Using calipers																																				
5	Dielectric Strength	No defects or abnormalities	No failure should be observed when 250% of the rated voltage is applied between the terminations for 1 to 5 seconds, provided the charge/discharge current is less than 50mA.																																				
6	Insulation Resistance	50Ω • F min.	The insulation resistance should be measured with a DC voltage not exceeding the rated voltage at 25°C and 75%RH max. and within 1 minute of charging.																																				
7	Capacitance	Within the specified tolerance	The capacitance/D.F. should be measured at 25°C at the frequency and voltage shown in the table.																																				
8	Dissipation Factor (D.F.)	R6 / R7 / C8 : 0.1 max. F5 : 0.2 max.	<table border="1" style="width: 100%; border-collapse: collapse; margin-bottom: 10px;"> <thead> <tr> <th>Capacitance</th> <th>Frequency</th> <th>Voltage</th> </tr> </thead> <tbody> <tr> <td>C ≤ 10μF (10V min.)*1</td> <td>1 ± 0.1kHz</td> <td>1.0 ± 0.2Vrms*1</td> </tr> <tr> <td>C ≤ 10μF (6.3V max.)</td> <td>1 ± 0.1kHz</td> <td>0.5 ± 0.1Vrms</td> </tr> <tr> <td>C &gt; 10μF</td> <td>120 ± 24Hz</td> <td>0.5 ± 0.1Vrms</td> </tr> </tbody> </table> <p>*1 Table 1 items are applied to 0.5+/-0.1Vrms.</p> <p>Table 1</p> <table style="width: 100%; border-collapse: collapse;"> <tr><td style="border-bottom: 1px solid black; padding: 2px;">GRM155R61A124-224K</td></tr> <tr><td style="border-bottom: 1px solid black; padding: 2px;">GRM185R61A105K</td></tr> <tr><td style="border-bottom: 1px solid black; padding: 2px;">GRM188R61A225K</td></tr> <tr><td style="border-bottom: 1px solid black; padding: 2px;">GRM219R61A475K</td></tr> </table>	Capacitance	Frequency	Voltage	C ≤ 10μF (10V min.)*1	1 ± 0.1kHz	1.0 ± 0.2Vrms*1	C ≤ 10μF (6.3V max.)	1 ± 0.1kHz	0.5 ± 0.1Vrms	C > 10μF	120 ± 24Hz	0.5 ± 0.1Vrms	GRM155R61A124-224K	GRM185R61A105K	GRM188R61A225K	GRM219R61A475K																				
			Capacitance	Frequency	Voltage																																		
C ≤ 10μF (10V min.)*1	1 ± 0.1kHz	1.0 ± 0.2Vrms*1																																					
C ≤ 10μF (6.3V max.)	1 ± 0.1kHz	0.5 ± 0.1Vrms																																					
C > 10μF	120 ± 24Hz	0.5 ± 0.1Vrms																																					
GRM155R61A124-224K																																							
GRM185R61A105K																																							
GRM188R61A225K																																							
GRM219R61A475K																																							
<table border="1" style="width: 100%; border-collapse: collapse;"> <thead> <tr> <th>Char.</th> <th>Temp. Range</th> <th>Reference Temp.</th> <th>Cap. Change</th> </tr> </thead> <tbody> <tr> <td>R6</td> <td>-55 to +85°C</td> <td>25°C</td> <td>Within ±15%</td> </tr> <tr> <td>R7</td> <td>-55 to +125°C</td> <td>25°C</td> <td>Within ±15%</td> </tr> <tr> <td>F5</td> <td>-30 to +85°C</td> <td>25°C</td> <td>Within +22/-82%</td> </tr> <tr> <td>C8</td> <td>-55 to +105°C</td> <td>25°C</td> <td>Within ±22%</td> </tr> </tbody> </table> <p>The capacitance change should be measured after 5 min. at each specified temperature stage. The ranges of capacitance change compared with the 25°C value over the temperature ranges shown in the table should be within the specified ranges. Measuring Voltage : GRM43 R6 0J/1A 336/476 : 1.0+/-0.2Vrms</p>	Char.	Temp. Range	Reference Temp.	Cap. Change	R6	-55 to +85°C	25°C	Within ±15%	R7	-55 to +125°C	25°C	Within ±15%	F5	-30 to +85°C	25°C	Within +22/-82%	C8	-55 to +105°C	25°C	Within ±22%																			
Char.	Temp. Range	Reference Temp.	Cap. Change																																				
R6	-55 to +85°C	25°C	Within ±15%																																				
R7	-55 to +125°C	25°C	Within ±15%																																				
F5	-30 to +85°C	25°C	Within +22/-82%																																				
C8	-55 to +105°C	25°C	Within ±22%																																				
9	Capacitance Temperature Characteristics																																						
10	Adhesive Strength of Termination	No removal of the terminations or other defects should occur.	<p>Solder the capacitor to the test jig (glass epoxy board) shown in Fig.1 using a eutectic solder. Then apply *210N force in parallel with the test jig for 10±1 sec. The soldering should be done either with an iron or using the reflow method and should be conducted with care so that the soldering is uniform and free of defects such as heat shock.</p> <p style="text-align: right;">*25N (GR□15, GRM18) / 2N (GR□03)</p> <div style="text-align: center;">  </div> <table border="1" style="width: 100%; border-collapse: collapse; margin-top: 10px;"> <thead> <tr> <th>Type</th> <th>a</th> <th>b</th> <th>c</th> </tr> </thead> <tbody> <tr><td>GR□03</td><td>0.3</td><td>0.9</td><td>0.3</td></tr> <tr><td>GR□15</td><td>0.4</td><td>1.5</td><td>0.5</td></tr> <tr><td>GRM18</td><td>1.0</td><td>3.0</td><td>1.2</td></tr> <tr><td>GRM21</td><td>1.2</td><td>4.0</td><td>1.65</td></tr> <tr><td>GRM31</td><td>2.2</td><td>5.0</td><td>2.0</td></tr> <tr><td>GRM32</td><td>2.2</td><td>5.0</td><td>2.9</td></tr> <tr><td>GRM43</td><td>3.5</td><td>7.0</td><td>3.7</td></tr> <tr><td>GRM55</td><td>4.5</td><td>8.0</td><td>5.6</td></tr> </tbody> </table> <p style="text-align: right;">(in mm)</p>	Type	a	b	c	GR□03	0.3	0.9	0.3	GR□15	0.4	1.5	0.5	GRM18	1.0	3.0	1.2	GRM21	1.2	4.0	1.65	GRM31	2.2	5.0	2.0	GRM32	2.2	5.0	2.9	GRM43	3.5	7.0	3.7	GRM55	4.5	8.0	5.6
			Type	a	b	c																																	
GR□03	0.3	0.9	0.3																																				
GR□15	0.4	1.5	0.5																																				
GRM18	1.0	3.0	1.2																																				
GRM21	1.2	4.0	1.65																																				
GRM31	2.2	5.0	2.0																																				
GRM32	2.2	5.0	2.9																																				
GRM43	3.5	7.0	3.7																																				
GRM55	4.5	8.0	5.6																																				
Fig.1																																							

Continued on the following page.

## Specifications and Test Methods

Continued from the preceding page.

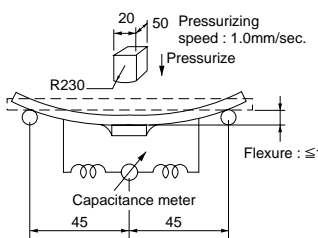
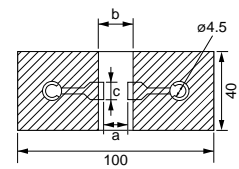
No.	Item	Specifications	Test Method																																				
11	Appearance	No defects or abnormalities	Solder the capacitor to the test jig (glass epoxy board) in the same manner and under the same conditions as (10). The capacitor should be subjected to a simple harmonic motion having a total amplitude of 1.5mm, the frequency being varied uniformly between the approximate limits of 10 and 55Hz. The frequency range, from 10 to 55Hz and return to 10Hz, should be traversed in approximately 1 minute. This motion should be applied for a period of 2 hours in each 3 mutually perpendicular directions (total of 6 hours).																																				
	Capacitance	Within the specified tolerance																																					
	D.F.	R6 / R7 / C8 : 0.1 max. F5 : 0.2 max.																																					
12	Deflection	No cracking or marking defects should occur.	<p>Solder the capacitor to the test jig (glass epoxy board) shown in Fig.2 using a eutectic solder. Then apply a force in the direction shown in Fig.3. The soldering should be done either with an iron or using the reflow method and should be conducted with care so that the soldering is uniform and free of defects such as heat shock.</p>  <p style="text-align: center;">Fig.3</p>  <table border="1" style="margin-left: auto; margin-right: auto;"> <thead> <tr> <th>Type</th> <th>a</th> <th>b</th> <th>c</th> </tr> </thead> <tbody> <tr> <td>GR□03</td> <td>0.3</td> <td>0.9</td> <td>0.3</td> </tr> <tr> <td>GR□15</td> <td>0.4</td> <td>1.5</td> <td>0.5</td> </tr> <tr> <td>GRM18</td> <td>1.0</td> <td>3.0</td> <td>1.2</td> </tr> <tr> <td>GRM21</td> <td>1.2</td> <td>4.0</td> <td>1.65</td> </tr> <tr> <td>GRM31</td> <td>2.2</td> <td>5.0</td> <td>2.0</td> </tr> <tr> <td>GRM32</td> <td>2.2</td> <td>5.0</td> <td>2.9</td> </tr> <tr> <td>GRM43</td> <td>3.5</td> <td>7.0</td> <td>3.7</td> </tr> <tr> <td>GRM55</td> <td>4.5</td> <td>8.0</td> <td>5.6</td> </tr> </tbody> </table> <p style="text-align: right;">(in mm)</p> <p style="text-align: center;">Fig.2</p>	Type	a	b	c	GR□03	0.3	0.9	0.3	GR□15	0.4	1.5	0.5	GRM18	1.0	3.0	1.2	GRM21	1.2	4.0	1.65	GRM31	2.2	5.0	2.0	GRM32	2.2	5.0	2.9	GRM43	3.5	7.0	3.7	GRM55	4.5	8.0	5.6
		Type		a	b	c																																	
GR□03	0.3	0.9	0.3																																				
GR□15	0.4	1.5	0.5																																				
GRM18	1.0	3.0	1.2																																				
GRM21	1.2	4.0	1.65																																				
GRM31	2.2	5.0	2.0																																				
GRM32	2.2	5.0	2.9																																				
GRM43	3.5	7.0	3.7																																				
GRM55	4.5	8.0	5.6																																				
13	Solderability of Termination	75% of the terminations is to be soldered evenly and continuously.	Immerse the capacitor in a solution of ethanol (JIS-K-8101) and rosin (JIS-K-5902) (25% rosin in weight proportion). Preheat at 80 to 120°C for 10 to 30 seconds. After preheating, immerse in eutectic solder solution for 2±0.5 seconds at 230±5°C.																																				
14	Resistance to Soldering Heat	Appearance	No marking defects																																				
		Capacitance Change	R6 / R7 / C8 : Within ±7.5% F5 : Within ±20%																																				
		D.F.	R6 / R7 / C8 : 0.1 max. F5 : 0.2 max.																																				
		I.R.	50Ω • F min.																																				
		Dielectric Strength	No failure																																				
15	Temperature Sudden Change	Appearance	No marking defects																																				
		Capacitance Change	R6 / R7 / C8 : Within ±7.5% F5 : Within ±20%																																				
		D.F.	R6 / R7 / C8 : 0.1 max. F5 : 0.2 max.																																				
		I.R.	50Ω • F min.																																				
		Dielectric Strength	No failure																																				

Continued on the following page. ↗



## Specifications and Test Methods

Continued from the preceding page.

No.	Item	Specifications	Test Method	
16	High Temperature	Appearance	Apply the rated voltage at $40 \pm 2^\circ\text{C}$ and 90 to 95% humidity for $500 \pm 12$ hours. The charge/discharge current is less than 50mA.  •Initial measurement Perform a heat treatment at $150 \pm 1,8^\circ\text{C}$ for one hour and then let sit for $48 \pm 4$ hours at room temperature. Perform the initial measurement.  •Measurement after test Perform a heat treatment at $150 \pm 1,8^\circ\text{C}$ for one hour and then let sit for $48 \pm 4$ hours at room temperature, then measure	
	High Humidity (Steady)	Capacitance Change		R6 / R7 / C8 : Within $\pm 12.5\%$ F5 : Within $\pm 30\%$
		D.F.		R6 / R7 / C8 : 0.2 max. F5 : 0.4 max.
		I.R.		$12.5\Omega \cdot \text{F min.}$
17	Durability	Appearance	Apply 150% of the rated voltage for $1000 \pm 12$ hours at the maximum operating temperature $\pm 3^\circ\text{C}$ . The charge/discharge current is less than 50mA.  •Initial measurement Perform a heat treatment at $150 \pm 1,8^\circ\text{C}$ for one hour and then let sit for $48 \pm 4$ hours at room temperature. Perform the initial measurement.  •Measurement after test Perform a heat treatment at $150 \pm 1,8^\circ\text{C}$ for one hour and then let sit for $48 \pm 4$ hours at room temperature, then measure.	
		Capacitance Change		R6 / R7 / C8 : Within $\pm 12.5\%$ F5 : Within $\pm 30\%$
		D.F.		R6 / R7 / C8 : 0.2 max. F5 : 0.4 max.
		I.R.		$25\Omega \cdot \text{F min.}$

5

# Chip Monolithic Ceramic Capacitors



## Low-dissipation Type

### ■ Features

1. Mobile telecommunication and RF module, mainly
2. Quality improvement of telephone calls, Low power consumption, yield ratio improvement

### ■ Applications

VCO, PA, Mobile Telecommunications

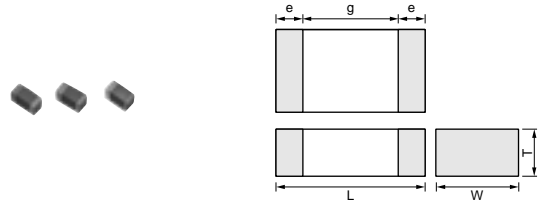

Part Number	Dimensions (mm)				
	L	W	T	e	g min.
<b>GJM15</b>	1.0 ±0.05	0.5 ±0.05	0.5 ±0.05	0.15 to 0.3	0.4
<b>GJM03</b>	0.6 ±0.03	0.3 ±0.03	0.3 ±0.03	0.1 to 0.2	0.2

Part Number	TC Code (Standard)	Rated Voltage (Vdc)	Capacitance (pF)	Length L (mm)	Width W (mm)	Thickness T (mm)
<b>GJM1555C1HR50CB01</b>	COG (EIA)	50	0.50 ±0.25pF	1.00	0.50	0.50
<b>GJM1555C1HR75CB01</b>	COG (EIA)	50	0.75 ±0.25pF	1.00	0.50	0.50
<b>GJM1555C1H1R0CB01</b>	COG (EIA)	50	1.0 ±0.25pF	1.00	0.50	0.50
<b>GJM1555C1H1R1CB01</b>	COG (EIA)	50	1.1 ±0.25pF	1.00	0.50	0.50
<b>GJM1555C1H1R2CB01</b>	COG (EIA)	50	1.2 ±0.25pF	1.00	0.50	0.50
<b>GJM1555C1H1R3CB01</b>	COG (EIA)	50	1.3 ±0.25pF	1.00	0.50	0.50
<b>GJM1555C1H1R5CB01</b>	COG (EIA)	50	1.5 ±0.25pF	1.00	0.50	0.50
<b>GJM1555C1H1R6CB01</b>	COG (EIA)	50	1.6 ±0.25pF	1.00	0.50	0.50
<b>GJM1555C1H1R8CB01</b>	COG (EIA)	50	1.8 ±0.25pF	1.00	0.50	0.50
<b>GJM1555C1H2R0CB01</b>	COG (EIA)	50	2.0 ±0.25pF	1.00	0.50	0.50
<b>GJM1555C1H2R2CB01</b>	COG (EIA)	50	2.2 ±0.25pF	1.00	0.50	0.50
<b>GJM1555C1H2R4CB01</b>	COG (EIA)	50	2.4 ±0.25pF	1.00	0.50	0.50
<b>GJM1555C1H2R7CB01</b>	COG (EIA)	50	2.7 ±0.25pF	1.00	0.50	0.50
<b>GJM1555C1H3R0CB01</b>	COG (EIA)	50	3.0 ±0.25pF	1.00	0.50	0.50
<b>GJM1555C1H3R3CB01</b>	COG (EIA)	50	3.3 ±0.25pF	1.00	0.50	0.50
<b>GJM1555C1H3R6CB01</b>	COG (EIA)	50	3.6 ±0.25pF	1.00	0.50	0.50
<b>GJM1555C1H3R9CB01</b>	COG (EIA)	50	3.9 ±0.25pF	1.00	0.50	0.50
<b>GJM1555C1H4R0CB01</b>	COG (EIA)	50	4.0 ±0.25pF	1.00	0.50	0.50
<b>GJM1555C1H4R3CB01</b>	COG (EIA)	50	4.3 ±0.25pF	1.00	0.50	0.50
<b>GJM1555C1H4R7CB01</b>	COG (EIA)	50	4.7 ±0.25pF	1.00	0.50	0.50
<b>GJM1555C1H5R0CB01</b>	COG (EIA)	50	5.0 ±0.25pF	1.00	0.50	0.50
<b>GJM1555C1H5R1CB01</b>	COG (EIA)	50	5.1 ±0.25pF	1.00	0.50	0.50
<b>GJM1555C1H5R6CB01</b>	COG (EIA)	50	5.6 ±0.25pF	1.00	0.50	0.50
<b>GJM1555C1H6R0CB01</b>	COG (EIA)	50	6.0 ±0.25pF	1.00	0.50	0.50
<b>GJM1555C1H6R0DB01</b>	COG (EIA)	50	6.0 ±0.5pF	1.00	0.50	0.50
<b>GJM1555C1H6R2CB01</b>	COG (EIA)	50	6.2 ±0.25pF	1.00	0.50	0.50
<b>GJM1555C1H6R8CB01</b>	COG (EIA)	50	6.8 ±0.25pF	1.00	0.50	0.50
<b>GJM1555C1H7R0CB01</b>	COG (EIA)	50	7.0 ±0.25pF	1.00	0.50	0.50
<b>GJM1555C1H7R0DB01</b>	COG (EIA)	50	7.0 ±0.5pF	1.00	0.50	0.50
<b>GJM1555C1H7R5CB01</b>	COG (EIA)	50	7.5 ±0.25pF	1.00	0.50	0.50
<b>GJM1555C1H8R0CB01</b>	COG (EIA)	50	8.0 ±0.25pF	1.00	0.50	0.50
<b>GJM1555C1H8R0DB01</b>	COG (EIA)	50	8.0 ±0.5pF	1.00	0.50	0.50
<b>GJM1555C1H8R2CB01</b>	COG (EIA)	50	8.2 ±0.25pF	1.00	0.50	0.50
<b>GJM1555C1H9R0CB01</b>	COG (EIA)	50	9.0 ±0.25pF	1.00	0.50	0.50
<b>GJM1555C1H9R0DB01</b>	COG (EIA)	50	9.0 ±0.5pF	1.00	0.50	0.50
<b>GJM1555C1H9R1CB01</b>	COG (EIA)	50	9.1 ±0.25pF	1.00	0.50	0.50
<b>GJM1555C1H100JB01</b>	COG (EIA)	50	10 ±5%	1.00	0.50	0.50
<b>GJM1555C1H100RB01</b>	COG (EIA)	50	10 ±2.5%	1.00	0.50	0.50

Continued on the following page.

☐ Continued from the preceding page.

Part Number	TC Code (Standard)	Rated Voltage (Vdc)	Capacitance (pF)	Length L (mm)	Width W (mm)	Thickness T (mm)
<b>GJM1555C1H120JB01</b>	COG (EIA)	50	12 ±5%	1.00	0.50	0.50
<b>GJM1555C1H150JB01</b>	COG (EIA)	50	15 ±5%	1.00	0.50	0.50
<b>GJM1555C1H180JB01</b>	COG (EIA)	50	18 ±5%	1.00	0.50	0.50

## Specifications and Test Methods

No.	Item	Specifications		Test Method									
		Temperature Compensating Type											
1	Operating Temperature Range	-55 to +125°C											
2	Rated Voltage	See the previous pages		The rated voltage is defined as the maximum voltage which may be applied continuously to the capacitor. When AC voltage is superimposed on DC voltage, $V^{P-P}$ or $V^{O-P}$ , whichever is larger, should be maintained within the rated voltage range.									
3	Appearance	No defects or abnormalities		Visual inspection									
4	Dimensions	Within the specified dimensions		Using calipers									
5	Dielectric Strength	No defects or abnormalities		No failure should be observed when 300% of the rated voltage is applied between the terminations for 1 to 5 seconds, provided the charge/discharge current is less than 50mA.									
6	Insulation Resistance (I.R.)	10,000MΩ min. or 500Ω • F min. (Whichever is smaller)		The insulation resistance should be measured with a DC voltage not exceeding the rated voltage at 25°C and 75%RH max. and within 2 minutes of charging.									
7	Capacitance	Within the specified tolerance		The capacitance/Q should be measured at 25°C at the frequency and voltage shown in the table.									
8	Q	30pF max. : $Q \geq 400 + 20C$ C : Nominal Capacitance (pF)		<table border="1"> <thead> <tr> <th>Item</th> <th>Char.</th> <th><math>\Delta C</math> (1000pF and below)</th> </tr> </thead> <tbody> <tr> <td>Frequency</td> <td></td> <td>1±0.1MHz</td> </tr> <tr> <td>Voltage</td> <td></td> <td>0.5 to 5Vr.m.s.</td> </tr> </tbody> </table>	Item	Char.	$\Delta C$ (1000pF and below)	Frequency		1±0.1MHz	Voltage		0.5 to 5Vr.m.s.
Item	Char.	$\Delta C$ (1000pF and below)											
Frequency		1±0.1MHz											
Voltage		0.5 to 5Vr.m.s.											
9	Capacitance Temperature Characteristics	Capacitance Change	Within the specified tolerance (Table A)	The capacitance change should be measured after 5 min. at each specified temperature stage. Temperature Compensating Type The temperature coefficient is determined using the capacitance measured in step 3 as a reference. When cycling the temperature sequentially from step 1 through 5, ( $\Delta C$ : +25°C to +125°C : other temp. coeffs. : +25°C to 85°C) the capacitance should be within the specified tolerance for the temperature coefficient and capacitance change as Table A. The capacitance drift is calculated by dividing the differences between the maximum and minimum measured values in steps 1, 3 and 5 by the capacitance value in step 3.									
		Temperature Coefficient	Within the specified tolerance (Table A)										
		Capacitance Drift	Within ±0.2% or ±0.05pF (Whichever is larger.)										
10	Adhesive Strength of Termination	No removal of the terminations or other defect should occur.		Solder the capacitor to the test jig (glass epoxy board) shown in Fig. 1 using a eutectic solder. Then apply a 5N* force in parallel with the test jig for 10±1sec. The soldering should be done either with an iron or using the reflow method and should be conducted with care so that the soldering is uniform and free of defects such as heat shock. *2N (GJM03)									

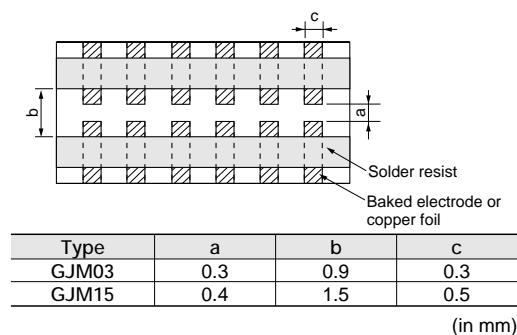

Fig. 1

Continued on the following page.

6

## Specifications and Test Methods

Continued from the preceding page.

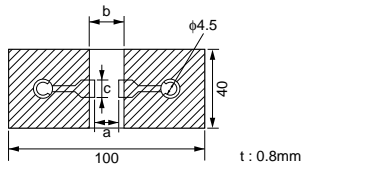
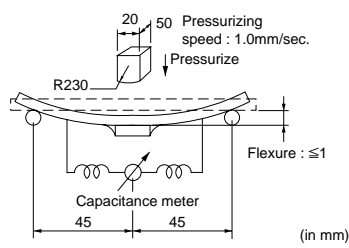
No.	Item	Specifications		Test Method															
		Temperature Compensating Type																	
11	Vibration Resistance	Appearance	No defects or abnormalities	Solder the capacitor to the test jig (glass epoxy board) in the same manner and under the same conditions as (10). The capacitor should be subjected to a simple harmonic motion having a total amplitude of 1.5mm, the frequency being varied uniformly between the approximate limits of 10 and 55Hz. The frequency range, from 10 to 55Hz and return to 10Hz, should be traversed in approximately 1 minute. This motion should be applied for a period of 2 hours in each of 3 mutually perpendicular directions (total of 6 hours).															
		Capacitance	Within the specified tolerance																
		Q	30pF max. : $Q \geq 400 + 20C$ C : Nominal Capacitance (pF)																
12	Deflection	No cracking or marking defects should occur		Solder the capacitor to the test jig (glass epoxy boards) shown in Fig. 2 using a eutectic solder. Then apply a force in the direction shown in Fig. 3. The soldering should be done either with an iron or using the reflow method and should be conducted with care so that the soldering is uniform and free of defects such as heat shock.															
		 <table border="1" style="margin: 10px auto; border-collapse: collapse;"> <thead> <tr> <th>Type</th> <th>a</th> <th>b</th> <th>c</th> </tr> </thead> <tbody> <tr> <td>GJM03</td> <td>0.3</td> <td>0.9</td> <td>0.3</td> </tr> <tr> <td>GJM15</td> <td>0.4</td> <td>1.5</td> <td>0.5</td> </tr> </tbody> </table> <p style="text-align: center;">(in mm)</p>			Type	a	b	c	GJM03	0.3	0.9	0.3	GJM15	0.4	1.5	0.5			
Type	a	b	c																
GJM03	0.3	0.9	0.3																
GJM15	0.4	1.5	0.5																
		 <p style="text-align: center;">(in mm)</p>		Fig. 3															
13	Solderability of Termination	75% of the terminations are to be soldered evenly and continuously.		Immerse the capacitor in a solution of ethanol (JIS-K-8101) and rosin (JIS-K-5902) (25% rosin in weight proportion). Preheat at 80 to 120°C for 10 to 30 seconds. After preheating, immerse in eutectic solder solution for 2±0.5 seconds at 230±5°C.															
14	Resistance to Soldering Heat	The measured and observed characteristics should satisfy the specifications in the following table.		Preheat the capacitor at 120 to 150°C for 1 minute. Immerse the capacitor in a eutectic solder solution at 270±5°C for 10±0.5 seconds. Let sit at room temperature for 24±2 hours.															
		Appearance	No marking defects																
		Capacitance Change	Within ±2.5% or ±0.25pF (Whichever is larger)																
		Q	30pF and below : $Q \geq 400 + 20C$ C : Nominal Capacitance (pF)																
		I.R.	More than 10,000MΩ or 500Ω • F (Whichever is smaller)																
	Dielectric Strength	No failure																	
15	Temperature Cycle	The measured and observed characteristics should satisfy the specifications in the following table.		Fix the capacitor to the supporting jig in the same manner and under the same conditions as (10). Perform the five cycles according to the four heat treatments listed in the following table. Let sit for 24±2 hours at room temperature, then measure.															
		Appearance	No marking defects																
		Capacitance Change	Within ±2.5% or ±0.25pF (Whichever is larger)																
		Q	30pF and below : $Q \geq 400 + 20C$ C : Nominal Capacitance (pF)																
		I.R.	More than 10,000MΩ or 500Ω • F (Whichever is smaller)																
	Dielectric Strength	No failure																	
		<table border="1" style="margin: 10px auto; border-collapse: collapse;"> <thead> <tr> <th>Step</th> <th>1</th> <th>2</th> <th>3</th> <th>4</th> </tr> </thead> <tbody> <tr> <td>Temp. (°C)</td> <td>Min. Operating Temp. <math>\pm 3</math></td> <td>Room Temp.</td> <td>Max. Operating Temp. <math>\pm 3</math></td> <td>Room Temp.</td> </tr> <tr> <td>Time (min.)</td> <td>30±3</td> <td>2 to 3</td> <td>30±3</td> <td>2 to 3</td> </tr> </tbody> </table>		Step	1	2	3	4	Temp. (°C)	Min. Operating Temp. $\pm 3$	Room Temp.	Max. Operating Temp. $\pm 3$	Room Temp.	Time (min.)	30±3	2 to 3	30±3	2 to 3	
Step	1	2	3	4															
Temp. (°C)	Min. Operating Temp. $\pm 3$	Room Temp.	Max. Operating Temp. $\pm 3$	Room Temp.															
Time (min.)	30±3	2 to 3	30±3	2 to 3															
16	Humidity, Steady State	The measured and observed characteristics should satisfy the specifications in the following table.		Let the capacitor sit at 40±2°C and 90 to 95% humidity for 500±12 hours. Remove and let sit for 24±2 hours (temperature compensating type) at room temperature, then measure.															
		Appearance	No marking defects																
		Capacitance Change	Within ±5% or ±0.5pF (Whichever is larger)																
		Q	10pF and over, 30pF and below : $Q \geq 275 + \frac{C}{2}$ 10pF and below : $Q \geq 200 + 10C$ C : Nominal Capacitance (pF)																
	I.R.	More than 10,000MΩ or 500Ω • F (Whichever is smaller)																	

Continued on the following page. ↗

## Specifications and Test Methods

Continued from the preceding page.

No.	Item	Specifications		Test Method
		Temperature Compensating Type		
17	Humidity Load	The measured and observed characteristics should satisfy the specifications in the following table.		Apply the rated voltage at 40±2°C and 90 to 95% humidity for 500±12 hours. Remove and let sit for 24±2 hours at room temperature, then measure. The charge/discharge current is less than 50mA.
		Appearance	No marking defects	
		Capacitance Change	Within ±7.5% or ±0.75pF (Whichever is larger)	
		Q	30pF and below : $Q \geq 100 + \frac{1}{C}$ C : Nominal Capacitance (pF)	
		I.R.	More than 500MΩ or 25Ω • F (Whichever is smaller)	
	Dielectric Strength	No failure		
18	High Temperature Load	The measured and observed characteristics should satisfy the specifications in the following table.		Apply 200% of the rated voltage for 1000±12 hours at the maximum operating temperature ±3°C. Let sit for 24±2 hours (temperature compensating type) at room temperature, then measure. The charge/discharge current is less than 50mA.
		Appearance	No marking defects	
		Capacitance Change	Within ±3% or ±0.3pF (Whichever is larger)	
		Q	10pF and over, 30pF and below : $Q \geq 275 + \frac{1}{C}$ 10pF and below : $Q \geq 200 + 10C$ C : Nominal Capacitance (pF)	
		I.R.	More than 1,000MΩ or 50Ω • F (Whichever is smaller)	
	Dielectric Strength	No failure		
19	ESR	0.5pF ≤ C ≤ 1pF : 350mΩ • pF below 1pF < C ≤ 5pF : 300mΩ below 5pF < C ≤ 10pF : 250mΩ below		The ESR should be measured at room Temperature. and frequency 1±0.2GHz with the equivalent of BOONTON Model 34A.
		10pF < C ≤ 20pF : 400mΩ below		The ESR should be measured at room Temperature. and frequency 500±50MHz with the equivalent of HP8753B.

Table A

Char. Code	Temp. Coeff. (ppm/°C) Note 1	Capacitance Change from 25°C Value (%)					
		-55°C		-30°C		-10°C	
		Max.	Min.	Max.	Min.	Max.	Min.
5C	0±30	0.58	-0.24	0.40	-0.17	0.25	-0.11

Note 1 : Nominal values denote the temperature coefficient within a range of 25 to 125°C. (for ΔC)

# GRM Series Data

## ■ Capacitance-Temperature Characteristics

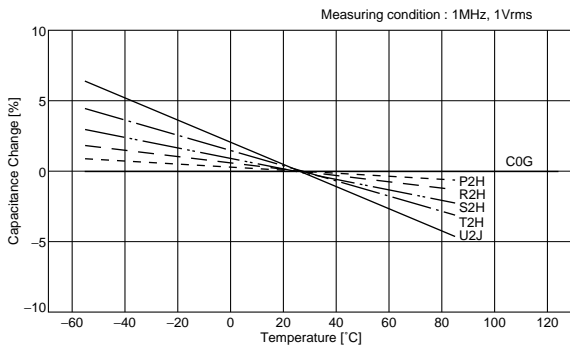

## ■ Capacitance-DC Voltage Characteristics

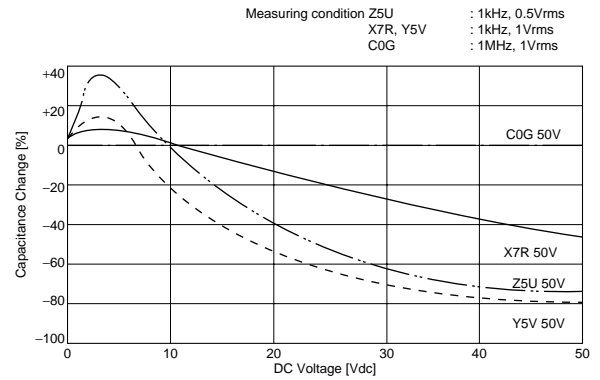

## ■ Capacitance-AC Voltage Characteristics

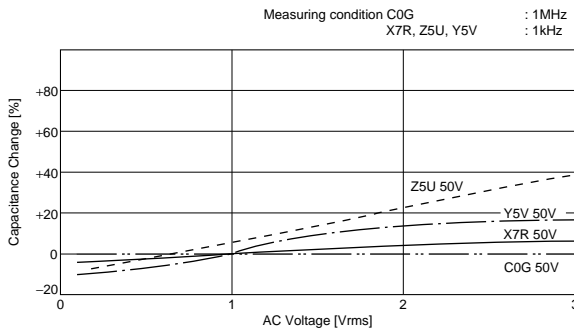

## ■ Capacitance Change-Aging

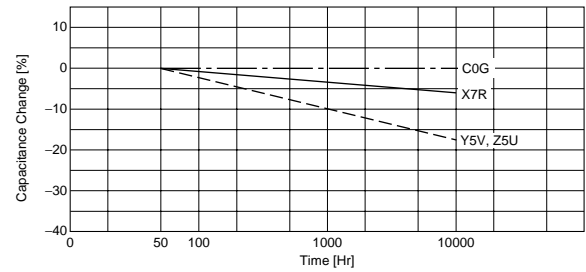

## ■ Impedance-Frequency Characteristics

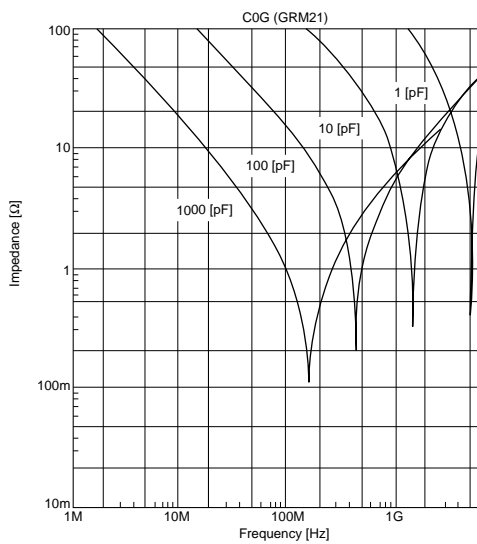

## ■ Allowable Voltage-Frequency

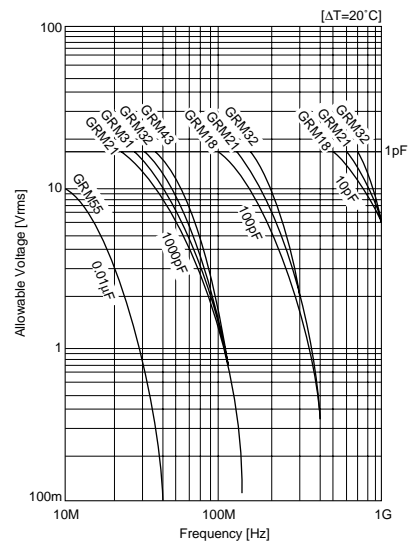

Continued on the following page. ↗

## GRM Series Data

Continued from the preceding page.

### ■ Allowable Current-Frequency

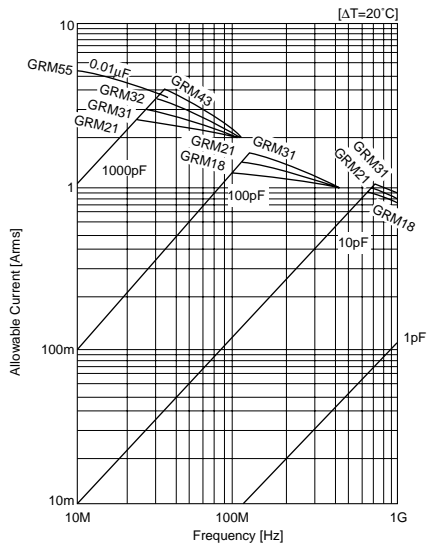

### ■ Allowable Apparent Power

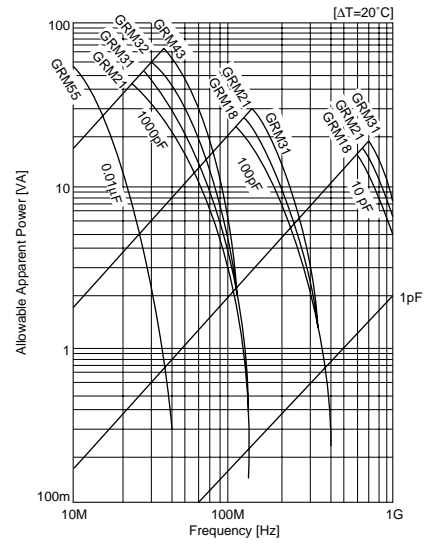



# Chip Monolithic Ceramic Capacitors



## Microchips

### ■ Features

1. Better microwave characteristics
2. Suitable for by-passing
3. High density mounting

### ■ Applications

1. Optical device for telecommunication
2. IC, IC packaging built-in
3. Measuring equipment

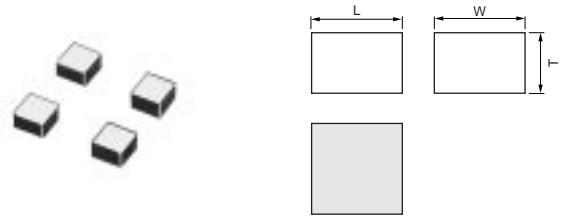

Part Number	Dimensions (mm)		
	L	W	T
<b>GMA05X</b>	0.5 ±0.05	0.5 ±0.05	0.35 ±0.05
<b>GMA085</b>	0.8 ±0.05	0.8 ±0.05	0.5 ±0.1

Part Number	TC Cod (Standard)	Rated Voltage (Vdc)	Capacitance	Length L (mm)	Width W (mm)	Thickness T (mm)
<b>GMA05XR71H471MD01</b>	X7R (EIA)	50	470pF ±20%	0.5	0.5	0.35
<b>GMA05XR71C102MD01</b>	X7R (EIA)	16	1000pF ±20%	0.5	0.5	0.35
<b>GMA05XR71C152MD01</b>	X7R (EIA)	16	1500pF ±20%	0.5	0.5	0.35
<b>GMA05XR71C222MD01</b>	X7R (EIA)	16	2200pF ±20%	0.5	0.5	0.35
<b>GMA085R71C103MD01</b>	X7R (EIA)	16	10000pF ±20%	0.8	0.8	0.5
<b>GMA05XF51C472ZD01</b>	Y5V (EIA)	16	4700pF +80/-20%	0.5	0.5	0.35
<b>GMA05XF51C682ZD01</b>	Y5V (EIA)	16	6800pF +80/-20%	0.5	0.5	0.35
<b>GMA085F51C473ZD01</b>	Y5V (EIA)	16	47000pF +80/-20%	0.8	0.8	0.5
<b>GMA05XF51A153ZD01</b>	Y5V (EIA)	10	15000pF +80/-20%	0.5	0.5	0.35
<b>GMA085F51A104ZD01</b>	Y5V (EIA)	10	0.10μF +80/-20%	0.8	0.8	0.5

## Specifications and Test Methods

No.	Item	Specifications	Test Method												
1	Operating Temperature	R7 : -55°C to +125°C F5 : -30°C to +85°C													
2	Rated Voltage	See the previous pages.	The rated voltage is defined as the maximum voltage which may be applied continuously to the capacitor. When AC voltage is superimposed on DC voltage, $V^{P-P}$ or $V^{O-P}$ , whichever is larger, should be maintained within the rated voltage range.												
3	Appearance	No defects or abnormalities	Visual inspection												
4	Dimensions	See the previous pages.	Visual inspection												
5	Dielectric Strength	No defects or abnormalities	No failure should be observed when a voltage of 250% of the rated voltage is applied between the both terminations for 1 to 5 seconds, provided the charge/discharge current is less than 50mA.												
6	Insulation Resistance (I.R.)	10,000MΩ min.	The insulation resistance should be measured with a DC voltage not exceeding the rated voltage at normal temperature and humidity and within 2 minutes of charging.												
7	Capacitance	Within the specified tolerance	The capacitance should be measured at 25°C with 1±0.1kHz in frequency and 1±0.2Vr.m.s. in voltage.												
8	Dissipation Factor (D.F.)	R7 : 0.035 max. F5 : 0.09 max. (for 16V) : 0.125 max. (for 10V)	D.F. should be measured under the same conditions at the capacitance.												
9	Capacitance Temperature Characteristics	<table border="1"> <thead> <tr> <th>Char.</th> <th>Temp. Range</th> <th>Reference Temp.</th> <th>Cap. Change Rate</th> </tr> </thead> <tbody> <tr> <td>R7</td> <td>-55 to +125°C</td> <td>25°C</td> <td>Within±15%</td> </tr> <tr> <td>F5</td> <td>-30 to +85°C</td> <td>25°C</td> <td>Within±22%</td> </tr> </tbody> </table>	Char.	Temp. Range	Reference Temp.	Cap. Change Rate	R7	-55 to +125°C	25°C	Within±15%	F5	-30 to +85°C	25°C	Within±22%	The range of capacitance change in reference to 25°C within the temperature range shown in the table should be within the specified ranges. The capacitance change should be measured after 5 min. at each specified temperature stage.
Char.	Temp. Range	Reference Temp.	Cap. Change Rate												
R7	-55 to +125°C	25°C	Within±15%												
F5	-30 to +85°C	25°C	Within±22%												
10	Mechanical Strength	Bond Strength	Pull force : 3.0g min.												
		Die Shear Strength	Die Shear force : 200g min.												
11	Vibration Resistance	Appearance	No defects or abnormalities												
		Capacitance	Within the specified tolerance												
		D.F.	R7 : 0.035 max. F5 : 0.09 max. (for 16V) : 0.125 max. (for 10V)												
12	Temperature Cycle	The measured values should satisfy the values in the following table.	The capacitor should be set for 48±4 hours at room temperature after one hour heat of treatment at 150±9°C, then measure for the initial measurement. Fix the capacitor to the supporting jig in the same manner and under the same conditions as (11) and conduct the five cycles according to the temperatures and time shown in the following table. Set it for 48±4 hours at room temperature, then measure.												
		<table border="1"> <thead> <tr> <th>Item</th> <th>Specifications</th> </tr> </thead> <tbody> <tr> <td>Appearance</td> <td>No marked defect</td> </tr> <tr> <td>Capacitance Change</td> <td>R7 ..... Within±7.5% F5 ..... Within±20%</td> </tr> <tr> <td>I.R.</td> <td>More than 10,000MΩ</td> </tr> <tr> <td>D.F.</td> <td>R7 ..... 0.035 max. F5 ..... 0.09 max.(for 16V) 0.125 max.(for 10V)</td> </tr> <tr> <td>Dielectric Strength</td> <td>No failure</td> </tr> </tbody> </table>		Item	Specifications	Appearance	No marked defect	Capacitance Change	R7 ..... Within±7.5% F5 ..... Within±20%	I.R.	More than 10,000MΩ	D.F.	R7 ..... 0.035 max. F5 ..... 0.09 max.(for 16V) 0.125 max.(for 10V)	Dielectric Strength	No failure
Item	Specifications														
Appearance	No marked defect														
Capacitance Change	R7 ..... Within±7.5% F5 ..... Within±20%														
I.R.	More than 10,000MΩ														
D.F.	R7 ..... 0.035 max. F5 ..... 0.09 max.(for 16V) 0.125 max.(for 10V)														
Dielectric Strength	No failure														
13	Humidity (Steady State)	The measured values should satisfy the values in the following table.	Set the capacitor for 500±12 hours at 40±20°C, in 90 to 95% humidity. Take it out and set it for 48±4 hours at room temperature, then measure.												
		<table border="1"> <thead> <tr> <th>Item</th> <th>Specifications</th> </tr> </thead> <tbody> <tr> <td>Appearance</td> <td>No marked defect</td> </tr> <tr> <td>Capacitance Change</td> <td>R7 ..... Within±12.5% F5 ..... Within±30%</td> </tr> <tr> <td>I.R.</td> <td>More than 1,000MΩ</td> </tr> <tr> <td>D.F.</td> <td>R7 ..... 0.05 max. F5 ..... 0.125 max.(for 16V) 0.15 max.(for 10V)</td> </tr> <tr> <td>Dielectric Strength</td> <td>No failure</td> </tr> </tbody> </table>		Item	Specifications	Appearance	No marked defect	Capacitance Change	R7 ..... Within±12.5% F5 ..... Within±30%	I.R.	More than 1,000MΩ	D.F.	R7 ..... 0.05 max. F5 ..... 0.125 max.(for 16V) 0.15 max.(for 10V)	Dielectric Strength	No failure
Item	Specifications														
Appearance	No marked defect														
Capacitance Change	R7 ..... Within±12.5% F5 ..... Within±30%														
I.R.	More than 1,000MΩ														
D.F.	R7 ..... 0.05 max. F5 ..... 0.125 max.(for 16V) 0.15 max.(for 10V)														
Dielectric Strength	No failure														

Continued on the following page. ↗

## Specifications and Test Methods

Continued from the preceding page.

No.	Item	Specifications	Test Method												
14	Humidity Load	<p>The measured values should satisfy the values in the following table.</p> <table border="1" style="width: 100%; border-collapse: collapse;"> <thead> <tr> <th style="text-align: center;">Item</th> <th style="text-align: center;">Specifications</th> </tr> </thead> <tbody> <tr> <td>Appearance</td> <td>No marked defect</td> </tr> <tr> <td>Capacitance Change</td> <td>R7 ..... Within <math>\pm 12.5\%</math> F5 ..... Within <math>\pm 30\%</math></td> </tr> <tr> <td>I.R.</td> <td>More than 500M<math>\Omega</math></td> </tr> <tr> <td>D.F.</td> <td>R7 ..... 0.05 max. F5 ..... 0.125 max.(for 16V) 0.15 max.(for 10V)</td> </tr> <tr> <td>Dielectric Strength</td> <td>No failure</td> </tr> </tbody> </table>	Item	Specifications	Appearance	No marked defect	Capacitance Change	R7 ..... Within $\pm 12.5\%$ F5 ..... Within $\pm 30\%$	I.R.	More than 500M $\Omega$	D.F.	R7 ..... 0.05 max. F5 ..... 0.125 max.(for 16V) 0.15 max.(for 10V)	Dielectric Strength	No failure	<p>Apply the rated voltage for 500<math>\pm</math>12 hours at 40<math>\pm</math>20<math>^{\circ}</math>C, in 90 to 95% humidity and set it for 48<math>\pm</math>4 hours at room temperature, then measure. The charge/discharge current is less than 50mA.</p> <ul style="list-style-type: none"> <li>Initial measurement for Y5V</li> </ul> <p>Perform a heat treatment at 150<math>\pm</math>10<math>^{\circ}</math>C for one hour and then let sit for 48<math>\pm</math>4 hours at room temperature. Perform the initial measurement.</p>
Item	Specifications														
Appearance	No marked defect														
Capacitance Change	R7 ..... Within $\pm 12.5\%$ F5 ..... Within $\pm 30\%$														
I.R.	More than 500M $\Omega$														
D.F.	R7 ..... 0.05 max. F5 ..... 0.125 max.(for 16V) 0.15 max.(for 10V)														
Dielectric Strength	No failure														
15	High Temperature Load	<p>The measured values should satisfy the values in the following table.</p> <table border="1" style="width: 100%; border-collapse: collapse;"> <thead> <tr> <th style="text-align: center;">Item</th> <th style="text-align: center;">Specifications</th> </tr> </thead> <tbody> <tr> <td>Appearance</td> <td>No marked defect</td> </tr> <tr> <td>Capacitance Change</td> <td>R7 ..... Within <math>\pm 12.5\%</math> F5 ..... Within <math>\pm 30\%</math></td> </tr> <tr> <td>I.R.</td> <td>More than 1,000M<math>\Omega</math></td> </tr> <tr> <td>D.F.</td> <td>R7 ..... 0.05 max. F5 ..... 0.125 max.(for 16V) 0.15 max.(for 10V)</td> </tr> <tr> <td>Dielectric Strength</td> <td>No failure</td> </tr> </tbody> </table>	Item	Specifications	Appearance	No marked defect	Capacitance Change	R7 ..... Within $\pm 12.5\%$ F5 ..... Within $\pm 30\%$	I.R.	More than 1,000M $\Omega$	D.F.	R7 ..... 0.05 max. F5 ..... 0.125 max.(for 16V) 0.15 max.(for 10V)	Dielectric Strength	No failure	<p>A voltage treatment should be given to the capacitor, in which a DC voltage of 200% the rated voltage is applied for one hour at the maximum operating temperature <math>\pm 3^{\circ}</math>C then it should be set for 48<math>\pm</math>4 hours at room temperature and the initial measurement should be conducted.</p> <p>Then apply the above mentioned voltage continuously for 1000<math>\pm</math>12 hours at the same temperature, remove it from the bath, and set it for 48<math>\pm</math>4 hours at room temperature, then measure. The charge/discharge current is less than 50mA.</p>
Item	Specifications														
Appearance	No marked defect														
Capacitance Change	R7 ..... Within $\pm 12.5\%$ F5 ..... Within $\pm 30\%$														
I.R.	More than 1,000M $\Omega$														
D.F.	R7 ..... 0.05 max. F5 ..... 0.125 max.(for 16V) 0.15 max.(for 10V)														
Dielectric Strength	No failure														

Mounting for testing : The capacitors should be mounted on the substrate as shown below using die bonding and wire bonding when tests No. 11 to 15 are performed.

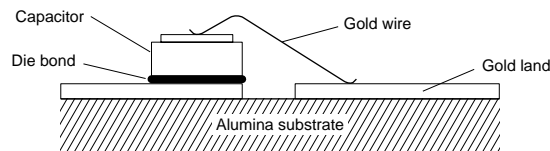
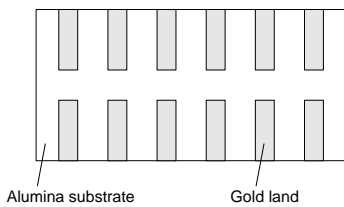

7

# Chip Monolithic Ceramic Capacitors



## Capacitor Arrays

### ■ Features

1. High density mounting due to mounting space saving
2. Mounting cost saving

### ■ Applications

General electronic equipment

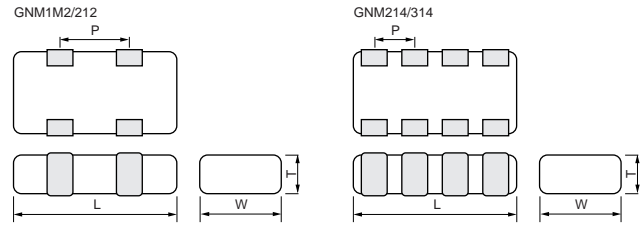

Part Number	Dimensions (mm)			
	L	W	T	P
<b>GNM1M2</b>	1.37 ±0.15	1.0 ±0.15	0.6 ±0.1	0.64 ±0.05
<b>GNM212</b>	2.0 ±0.15	1.25 ±0.15	0.85 ±0.1	1.0 ±0.1
<b>GNM214</b>			0.6 ±0.1	0.5 ±0.05
<b>GNM314</b>	3.2 ±0.15	1.6 ±0.15	0.8 ±0.1	0.8 ±0.1
			1.0 ±0.1	

8

## Temperature Compensating Type

Part Number	<b>GNM31</b>	
L x W	3.2x1.6	
TC	COG (5C)	
Rated Volt.	100 (2A)	50 (1H)
Capacitance (Capacitance part numbering code) and T (mm) Dimension (T Dimension part numbering code)		
10pF(100)	0.8(4)	0.8(4)
11pF(110)	0.8(4)	0.8(4)
12pF(120)	0.8(4)	0.8(4)
13pF(130)	0.8(4)	0.8(4)
15pF(150)	0.8(4)	0.8(4)
16pF(160)	0.8(4)	0.8(4)
18pF(180)	0.8(4)	0.8(4)
20pF(200)	0.8(4)	0.8(4)
22pF(220)	0.8(4)	0.8(4)
24pF(240)	0.8(4)	0.8(4)
27pF(270)	0.8(4)	0.8(4)
30pF(300)	0.8(4)	0.8(4)
33pF(330)	0.8(4)	0.8(4)
36pF(360)	0.8(4)	0.8(4)
39pF(390)	0.8(4)	0.8(4)
43pF(430)	0.8(4)	0.8(4)
47pF(470)	0.8(4)	0.8(4)
51pF(510)	0.8(4)	0.8(4)
56pF(560)	0.8(4)	0.8(4)
62pF(620)	0.8(4)	0.8(4)
68pF(680)	0.8(4)	0.8(4)
75pF(750)	0.8(4)	0.8(4)
82pF(820)	0.8(4)	0.8(4)
91pF(910)	0.8(4)	0.8(4)
100pF(101)	0.8(4)	0.8(4)
110pF(111)	0.8(4)	0.8(4)
120pF(121)	0.8(4)	0.8(4)
130pF(131)	0.8(4)	0.8(4)
150pF(151)	0.8(4)	0.8(4)
160pF(161)		0.8(4)
180pF(181)		0.8(4)

Continued on the following page.

Continued from the preceding page.

Part Number	<b>GNM31</b>		
L x W	3.2x1.6		
TC	C0G (5C)		
Rated Volt.	100 (2A)	50 (1H)	
Capacitance (Capacitance part numbering code) and T (mm) Dimension (T Dimension part numbering code)			
200pF(201)		0.8(4)	
220pF(221)		0.8(4)	
240pF(241)		0.8(4)	
270pF(271)		0.8(4)	
300pF(301)		0.8(4)	
330pF(331)		0.8(4)	
360pF(361)		0.8(4)	

The part numbering code is shown in each ( ). The (4) code in T(mm) means number of elements (four).  
Dimensions are shown in mm and Rated Voltage in Vdc.

### High Dielectric Constant Type GNM1 Series

Part Number	<b>GNM1M</b>		
L x W	1.37x1.00		
TC	X7R (R7)		
Rated Volt.	16 (1C)	10 (1A)	
Capacitance (Capacitance part numbering code) and T (mm) Dimension (T Dimension part numbering code)			
22000pF(223)	0.6(2)		
47000pF(473)	0.6(2)		
0.10μF(104)		0.6(2)	

The part numbering code is shown in each ( ). The (2) code in T(mm) means number of elements (two).  
Dimensions are shown in mm and Rated Voltage in Vdc.

### High Dielectric Constant Type GNM2 Series

Part Number	<b>GNM21</b>		
L x W	2.0x1.25		
TC	X7R (R7)		
Rated Volt.	50 (1H)		
Capacitance (Capacitance part numbering code) and T (mm) Dimension (T Dimension part numbering code)			
1000pF(102)	0.6(4)		
10000pF(103)	0.6(4)		

The part numbering code is shown in each ( ). The (4) code in T(mm) means number of elements (four).  
Dimensions are shown in mm and Rated Voltage in Vdc.

### High Dielectric Constant Type GNM3 Series

Part Number	<b>GNM31</b>						
L x W	3.2x1.6						
TC	X7R (R7)				Y5V (F5)		
Rated Volt.	100 (2A)	50 (1H)	25 (1E)	16 (1C)	100 (2A)	50 (1H)	16 (1C)
Capacitance (Capacitance part numbering code) and T (mm) Dimension (T Dimension part numbering code)							
220pF(221)	0.8(4)						

Continued on the following page. 

Continued from the preceding page.

Part Number	GNM31						
L x W	3.2x1.6						
TC	X7R (R7)				Y5V (F5)		
Rated Volt.	100 (2A)	50 (1H)	25 (1E)	16 (1C)	100 (2A)	50 (1H)	16 (1C)
Capacitance (Capacitance part numbering code) and T (mm) Dimension (T Dimension part numbering code)							
270pF(271)	0.8(4)						
330pF(331)	0.8(4)						
390pF(391)	0.8(4)	0.8(4)					
470pF(471)	0.8(4)	0.8(4)					
560pF(561)	0.8(4)	0.8(4)					
680pF(681)	0.8(4)	0.8(4)					
820pF(821)	0.8(4)	0.8(4)					
1000pF(102)	0.8(4)	0.8(4)					
1200pF(122)	0.8(4)	0.8(4)					
1500pF(152)	0.8(4)	0.8(4)					
1800pF(182)	0.8(4)	0.8(4)					
2200pF(222)	0.8(4)	0.8(4)			0.8(4)		
2700pF(272)	0.8(4)	0.8(4)					
3300pF(332)	0.8(4)	0.8(4)			0.8(4)		
3900pF(392)	0.8(4)	0.8(4)					
4700pF(472)	0.8(4)	0.8(4)			0.8(4)		
5600pF(562)		0.8(4)					
6800pF(682)		0.8(4)					
8200pF(822)		0.8(4)					
10000pF(103)		0.8(4)					
12000pF(123)		0.8(4)					
15000pF(153)		0.8(4)					
18000pF(183)			0.8(4)				
22000pF(223)				0.8(4)		0.8(4)	
27000pF(273)				0.8(4)			
33000pF(333)				0.8(4)		0.8(4)	
39000pF(393)				0.8(4)			
47000pF(473)				1.0(4)		0.8(4)	
68000pF(683)				1.0(4)			0.8(4)
0.10μF(104)				1.0(4)			0.8(4)
0.15μF(154)							0.8(4)

The part numbering code is shown in each ( ). The (4) code in T(mm) means number of elements (four).  
 Dimensions are shown in mm and Rated Voltage in Vdc.

## Specifications and Test Methods

No.	Item	Specifications		Test Method																							
		Temperature Compensating Type	High Dielectric Type																								
1	Operating Temperature Range	5C : -55°C to +125°C	R7 : -55°C to +125°C F5 : -30°C to +85°C																								
2	Rated Voltage	See the previous pages.		The rated voltage is defined as the maximum voltage which may be applied continuously to the capacitor. When AC voltage is superimposed on DC voltage, $V^{P-P}$ or $V^{O-P}$ , whichever is larger, should be maintained within the rated voltage range.																							
3	Appearance	No defects or abnormalities		Visual inspection																							
4	Dimension	Within the specified dimensions		Using calipers																							
5	Dielectric Strength	No defects or abnormalities		No failure should be observed when 300% of the rated voltage (5C) or 250% of the rated voltage (R7, F5) is applied between the terminations for 1 to 5 seconds, provided the charge/discharge current is less than 50mA.																							
6	Insulation Resistance	More than 10,000MΩ or 500Ω • F (Whichever is smaller)		The insulation resistance should be measured with a DC voltage not exceeding the rated voltage at 25°C and 75%RH max. and within 2 minutes of charging.																							
7	Capacitance	Within the specified tolerance		The capacitance/Q/D.F. should be measured at 25°C at the frequency and voltage shown in the table.																							
8	Q/Dissipation Factor (D.F.)	30pF min. : $Q \geq 1000$ 30pF max. : $Q \geq 400+20C$  C : Nominal Capacitance (pF)	<table border="1" style="font-size: small;"> <tr> <th>Char.</th> <th>25V min.</th> <th>16V</th> <th>10V</th> </tr> <tr> <td>R7</td> <td>0.025 max.</td> <td>0.035 max.</td> <td>0.035 max.</td> </tr> <tr> <td>F5</td> <td>0.05 max.</td> <td>0.07 max.</td> <td>—</td> </tr> </table>	Char.	25V min.	16V	10V	R7	0.025 max.	0.035 max.	0.035 max.	F5	0.05 max.	0.07 max.	—	<table border="1" style="font-size: small;"> <tr> <th>Item \ Char.</th> <th>5C</th> <th>R7, F5</th> </tr> <tr> <td>Frequency</td> <td>1±0.1MHz</td> <td>1±0.1kHz</td> </tr> <tr> <td>Voltage</td> <td>0.5 to 5Vr.m.s.</td> <td>1.0±0.2Vr.m.s.</td> </tr> </table>	Item \ Char.	5C	R7, F5	Frequency	1±0.1MHz	1±0.1kHz	Voltage	0.5 to 5Vr.m.s.	1.0±0.2Vr.m.s.		
			Char.	25V min.	16V	10V																					
R7	0.025 max.	0.035 max.	0.035 max.																								
F5	0.05 max.	0.07 max.	—																								
Item \ Char.	5C	R7, F5																									
Frequency	1±0.1MHz	1±0.1kHz																									
Voltage	0.5 to 5Vr.m.s.	1.0±0.2Vr.m.s.																									
9	Capacitance Temperature Characteristics	Capacitance Change	Within the specified tolerance (Table A)	<table border="1" style="font-size: small;"> <tr> <th>Char.</th> <th>Temp. Range</th> <th>Reference Temp.</th> <th>Cap. Change</th> </tr> <tr> <td>R7</td> <td>-55 to +125°C</td> <td rowspan="2">25°C</td> <td>Within ±15%</td> </tr> <tr> <td>F5</td> <td>-30 to +85°C</td> <td>Within ±22%</td> </tr> </table> <p>The capacitance change should be measured after 5 min. at each specified temperature stage.</p> <p>(1) Temperature Compensating Type The temperature coefficient is determined using the capacitance measured in step 3 as a reference. When cycling the temperature sequentially from step 1 through 5, the capacitance should be within the specified tolerance for the temperature coefficient and capacitance change as Table A.</p> <p>The capacitance drift is calculated by dividing the differences between the maximum and minimum measured values in steps 1, 3 and 5 by the capacitance value in step 3.</p> <table border="1" style="font-size: small; margin: 10px auto;"> <thead> <tr> <th>Step</th> <th>Temperature (°C)</th> </tr> </thead> <tbody> <tr> <td>1</td> <td>25±2</td> </tr> <tr> <td>2</td> <td>-55±3 (for 5C/ R7), -30±3 (for F5)</td> </tr> <tr> <td>3</td> <td>25±2</td> </tr> <tr> <td>4</td> <td>125±3 (for 5C/R7), 85±3 (F5)</td> </tr> <tr> <td>5</td> <td>25±2</td> </tr> </tbody> </table> <p>(2) High Dielectric Constant Type The ranges of capacitance change compared with the above 25°C value over the temperature ranges shown in the table should be within the specified ranges.</p>	Char.	Temp. Range	Reference Temp.	Cap. Change	R7	-55 to +125°C	25°C	Within ±15%	F5	-30 to +85°C	Within ±22%	Step	Temperature (°C)	1	25±2	2	-55±3 (for 5C/ R7), -30±3 (for F5)	3	25±2	4	125±3 (for 5C/R7), 85±3 (F5)	5	25±2
		Char.	Temp. Range		Reference Temp.	Cap. Change																					
		R7	-55 to +125°C		25°C	Within ±15%																					
F5	-30 to +85°C	Within ±22%																									
Step	Temperature (°C)																										
1	25±2																										
2	-55±3 (for 5C/ R7), -30±3 (for F5)																										
3	25±2																										
4	125±3 (for 5C/R7), 85±3 (F5)																										
5	25±2																										
Temperature Coefficient	Within the specified tolerance (Table A)																										
Capacitance Drift	Within ±0.2% or ±0.05 pF (Whichever is larger)																										
10	Adhesive Strength of Termination	No removal of the terminations or other defect should occur.		<p>Solder the capacitor to the test jig (glass epoxy board) shown in Fig. 1 using a eutectic solder. Then apply 5N force in parallel with the test jig for 10±1 sec.</p> <p>The soldering should be done either with an iron or using the reflow method and should be conducted with care so that the soldering is uniform and free of defects such as heat shock.</p> <table border="1" style="font-size: small; margin: 10px auto;"> <thead> <tr> <th>Type</th> <th>a</th> <th>b</th> <th>c</th> <th>d</th> </tr> </thead> <tbody> <tr> <td>GNM1M</td> <td>0.5</td> <td>—</td> <td>0.32</td> <td>0.32</td> </tr> <tr> <td>GNM21</td> <td>0.4</td> <td>1.6</td> <td>0.25</td> <td>0.5</td> </tr> <tr> <td>GNM31</td> <td>0.8</td> <td>2.5</td> <td>0.4</td> <td>0.8</td> </tr> </tbody> </table> <p style="text-align: right;">(in mm)</p>	Type	a	b	c	d	GNM1M	0.5	—	0.32	0.32	GNM21	0.4	1.6	0.25	0.5	GNM31	0.8	2.5	0.4	0.8			
		Type	a		b	c	d																				
GNM1M	0.5	—	0.32	0.32																							
GNM21	0.4	1.6	0.25	0.5																							
GNM31	0.8	2.5	0.4	0.8																							

Fig. 1

Continued on the following page.

## Specifications and Test Methods

Continued from the preceding page.

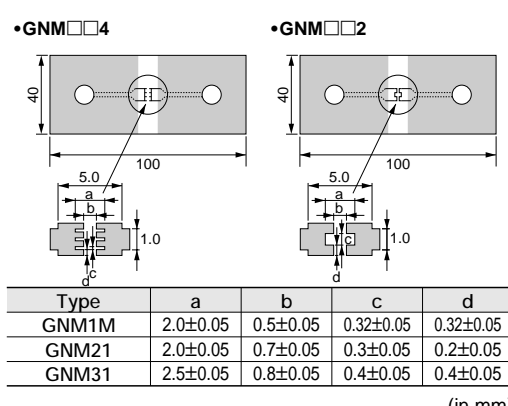
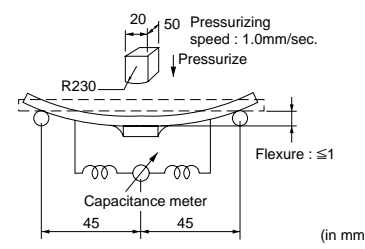
No.	Item	Specifications			Test Method																	
		Temperature Compensating Type	High Dielectric Type																			
11	Vibration Resistance	Appearance	No defects or abnormalities			Solder the capacitor to the test jig (glass epoxy board) in the same manner and under the same conditions as (10). The capacitor should be subjected to a simple harmonic motion having a total amplitude of 1.5mm, the frequency being varied uniformly between the approximate limits of 10 and 55Hz. The frequency range, from 10 to 55Hz and return to 10Hz, should be traversed in approximately 1 minute. This motion should be applied for a period of 2 hours in each of 3 mutually perpendicular directions (total of 6 hours).																
		Capacitance	Within the specified tolerance																			
Q/D.F.	30pF min. : $Q \geq 1000$ 30pF max. : $Q \geq 400+20C$  C : Nominal Capacitance (pF)	<table border="1" style="font-size: small;"> <tr> <th>Char.</th> <th>25V min.</th> <th>16V</th> <th>10V</th> </tr> <tr> <td>R7</td> <td>0.025 max.</td> <td>0.035 max.</td> <td>0.035 max.</td> </tr> <tr> <td>F5</td> <td>0.05 max.</td> <td>0.07 max.</td> <td>—</td> </tr> </table>			Char.		25V min.	16V	10V	R7	0.025 max.	0.035 max.	0.035 max.	F5	0.05 max.	0.07 max.	—					
		Char.	25V min.	16V	10V																	
R7	0.025 max.	0.035 max.	0.035 max.																			
F5	0.05 max.	0.07 max.	—																			
12	Deflection	No cracking or marking defects should occur.			Solder the capacitor on the test jig (glass epoxy board) shown in Fig. 2 using a eutectic solder. Then apply a force in the direction shown in Fig. 3 for $5 \pm 1$ sec. The soldering should be done either with an iron or using the reflow method and should be conducted with care so that the soldering is uniform and free of defects such as heat shock.																	
		 <table border="1" style="font-size: x-small; margin: 10px auto;"> <thead> <tr> <th>Type</th> <th>a</th> <th>b</th> <th>c</th> <th>d</th> </tr> </thead> <tbody> <tr> <td>GNM1M</td> <td>2.0±0.05</td> <td>0.5±0.05</td> <td>0.32±0.05</td> <td>0.32±0.05</td> </tr> <tr> <td>GNM21</td> <td>2.0±0.05</td> <td>0.7±0.05</td> <td>0.3±0.05</td> <td>0.2±0.05</td> </tr> <tr> <td>GNM31</td> <td>2.5±0.05</td> <td>0.8±0.05</td> <td>0.4±0.05</td> <td>0.4±0.05</td> </tr> </tbody> </table> <p style="text-align: center;">(in mm)</p>				Type	a	b	c	d	GNM1M	2.0±0.05	0.5±0.05	0.32±0.05	0.32±0.05	GNM21	2.0±0.05	0.7±0.05	0.3±0.05	0.2±0.05	GNM31	2.5±0.05
Type	a	b	c	d																		
GNM1M	2.0±0.05	0.5±0.05	0.32±0.05	0.32±0.05																		
GNM21	2.0±0.05	0.7±0.05	0.3±0.05	0.2±0.05																		
GNM31	2.5±0.05	0.8±0.05	0.4±0.05	0.4±0.05																		
		 <p style="text-align: center;">(in mm)</p>																				
		Fig. 2			Fig. 3																	
					$t=0.8\text{mm (GNM21), } 1.6\text{mm (GNM31)}$																	
13	Solderability of Termination	75% of the terminations are to be soldered evenly and continuously.			Immerse the capacitor in a solution of ethanol (JIS-K-8101) and rosin (JIS-K-5902) (25% rosin in weight proportion). Preheat at 80 to 120°C for 10 to 30 seconds. After preheating, immerse in eutectic solder solution for $2 \pm 0.5$ seconds at $230 \pm 5^\circ\text{C}$ .																	
14	Resistance to Soldering Heat	The measured and observed characteristics should satisfy the specifications in the following table.			Preheat the capacitor at 120 to 150°C for 1 minute. Immerse the capacitor in a eutectic solder solution at $270 \pm 5^\circ\text{C}$ for $10 \pm 0.5$ seconds. Let sit at room temperature for $24 \pm 2$ hours (temperature compensating type) or $48 \pm 4$ hours (high dielectric constant type), then measure.  • Initial measurement for high dielectric constant type Perform a heat treatment at $150 \pm 9.0^\circ\text{C}$ for one hour and then let sit for $48 \pm 4$ hours at room temperature. Perform the initial measurement.																	
		Appearance	No marking defects																			
		Capacitance Change	Within $\pm 2.5\%$ or $\pm 0.25\text{pF}$ (Whichever is larger)	R7 : Within $\pm 7.5\%$ F5 : Within $\pm 20\%$																		
		Q/D.F.	30pF min. : $Q \geq 1000$ 30pF max. : $Q \geq 400+20C$  C : Nominal Capacitance (pF)	<table border="1" style="font-size: x-small;"> <tr> <th>Char.</th> <th>25V min.</th> <th>16V</th> <th>10V</th> </tr> <tr> <td>R7</td> <td>0.025 max.</td> <td>0.035 max.</td> <td>0.035 max.</td> </tr> <tr> <td>F5</td> <td>0.05 max.</td> <td>0.07 max.</td> <td>—</td> </tr> </table>			Char.	25V min.	16V	10V	R7	0.025 max.	0.035 max.	0.035 max.	F5	0.05 max.	0.07 max.	—				
				Char.		25V min.	16V	10V														
R7	0.025 max.	0.035 max.	0.035 max.																			
F5	0.05 max.	0.07 max.	—																			
I.R.	More than $10,000\text{M}\Omega$ or $500\Omega \cdot \text{F}$ (Whichever is smaller)																					
Dielectric Strength	No failure																					
15	Temperature Cycle	The measured and observed characteristics should satisfy the specifications in the following table.			Fix the capacitor to the supporting jig in the same manner and under the same conditions as (10). Perform the five cycles according to the four heat treatments listed in the following table. Let sit for $24 \pm 2$ hours (temperature compensating type) or $48 \pm 4$ hours (high dielectric constant type) at room temperature, then measure  <table border="1" style="font-size: x-small; margin: 10px auto;"> <thead> <tr> <th>Step</th> <th>1</th> <th>2</th> <th>3</th> <th>4</th> </tr> </thead> <tbody> <tr> <td>Temp. (<math>^\circ\text{C}</math>)</td> <td>Min. Operating Temp. <math>\pm 9.0</math></td> <td>Room Temp.</td> <td>Max. Operating Temp. <math>\pm 3.0</math></td> <td>Room Temp.</td> </tr> <tr> <td>Time (min.)</td> <td><math>30 \pm 3</math></td> <td>2 to 3</td> <td><math>30 \pm 3</math></td> <td>2 to 3</td> </tr> </tbody> </table> • Initial measurement for high dielectric constant type Perform a heat treatment at $150 \pm 9.0^\circ\text{C}$ for one hour and then let sit for $48 \pm 4$ hours at room temperature. Perform the initial measurement.	Step	1	2	3	4	Temp. ( $^\circ\text{C}$ )	Min. Operating Temp. $\pm 9.0$	Room Temp.	Max. Operating Temp. $\pm 3.0$	Room Temp.	Time (min.)	$30 \pm 3$	2 to 3	$30 \pm 3$	2 to 3		
		Step	1	2		3	4															
		Temp. ( $^\circ\text{C}$ )	Min. Operating Temp. $\pm 9.0$	Room Temp.		Max. Operating Temp. $\pm 3.0$	Room Temp.															
		Time (min.)	$30 \pm 3$	2 to 3		$30 \pm 3$	2 to 3															
		Appearance	No marking defects																			
Capacitance Change	Within $\pm 2.5\%$ or $\pm 0.25\text{pF}$ (Whichever is larger)	R7 : Within $\pm 7.5\%$ F5 : Within $\pm 20\%$																				
Q/D.F.	30pF min. : $Q \geq 1000$ 30pF max. : $Q \geq 400+20C$  C : Nominal Capacitance (pF)	<table border="1" style="font-size: x-small;"> <tr> <th>Char.</th> <th>25V min.</th> <th>16V</th> <th>10V</th> </tr> <tr> <td>R7</td> <td>0.025 max.</td> <td>0.035 max.</td> <td>0.035 max.</td> </tr> <tr> <td>F5</td> <td>0.05 max.</td> <td>0.07 max.</td> <td>—</td> </tr> </table>			Char.	25V min.	16V	10V	R7	0.025 max.	0.035 max.	0.035 max.	F5	0.05 max.	0.07 max.	—						
		Char.	25V min.	16V	10V																	
R7	0.025 max.	0.035 max.	0.035 max.																			
F5	0.05 max.	0.07 max.	—																			
I.R.	More than $10,000\text{M}\Omega$ or $500\Omega \cdot \text{F}$ (Whichever is smaller)																					
Dielectric Strength	No failure																					

Continued on the following page.



## Specifications and Test Methods

Continued from the preceding page.

No.	Item	Specifications				Test Method		
		Temperature Compensating Type		High Dielectric Type				
16	Humidity Steady State	The measured and observed characteristics should satisfy the specifications in the following table.				Let the capacitor sit at 40±2°C and 90 to 95% humidity for 500±12 hours. Remove and let sit for 24±2 hours (temperature compensating type) or 48±4 hours (high dielectric constant type) at room temperature, then measure.		
		Appearance	No marking defects					
		Capacitance Change	Within ±5% or ±0.5pF (Whichever is larger)	R7 : Within ±12.5% F5 : Within ±30%				
		Q/D.F.	30pF and over : Q≥350 10pF and over, 30pF and below : Q≥275+5C/2 10pF and below : Q≥200+10C C : Nominal Capacitance (pF)	Char.	25V min.		16V	10V
				R7	0.025 max.		0.035 max.	0.035 max.
				F5	0.05 max.		0.07 max.	—
I.R.	More than 1,000MΩ or 50Ω • F (Whichever is smaller)							
Dielectric Strength	No failure							
17	Humidity Load	The measured and observed characteristics should satisfy the specifications in the following table.				Apply the rated voltage at 40±2°C and 90 to 95% humidity for 500±12 hours. Remove and let sit for 24±2 hours (temperature compensating type) or 48±4 hours (high dielectric constant type) at room temperature, then measure. The charge/discharge current is less than 50mA.		
		Appearance	No marking defects					
		Capacitance Change	Within ±7.5% or ±0.75pF (Whichever is larger)	R7 : Within ±12.5% F5 : Within ±30%				
		Q/D.F.	30pF and over : Q≥200 30pF and below : Q≥100+10C/3 C : Nominal Capacitance (pF)	Char.	25V min.		16V	10V
				R7	0.025 max.		0.035 max.	0.035 max.
				F5	0.05 max.		0.07 max.	—
I.R.	More than 500MΩ or 25Ω • F (Whichever is smaller)							
Dielectric Strength	No failure							
18	High Temperature Load	The measured and observed characteristics should satisfy the specifications in the following table.				Apply 200% of the rated voltage for 1000±12 hours at the maximum operating temperature ±3°C. Let sit for 24±2 hours (temperature compensating type) or 48±4 hours (high dielectric constant type) at room temperature, then measure. The charge/discharge current is less than 50mA.  •Initial measurement for high dielectric constant type. Apply 200% of the rated DC voltage for one hour at the maximum operating temperature ±3°C. Remove and let sit for 48±4 hours at room temperature. Perform initial measurement.		
		Appearance	No marking defects					
		Capacitance Change	Within ±3% or ±0.3pF (Whichever is larger)	R7 : Within ±12.5% F5 : Within ±30%				
		Q/D.F.	30pF and over : Q≥350 10pF and over, 30pF and below : Q≥275+5C/2 10pF and below : Q≥200+10C C : Nominal Capacitance (pF)	Char.	25V min.		16V	10V
				R7	0.025 max.		0.035 max.	0.035 max.
				F5	0.05 max.		0.07 max.	—
I.R.	More than 1,000MΩ or 50Ω • F (Whichever is smaller)							
Dielectric Strength	No failure							

8

**Table A**

Char.	Nominal Values (ppm/°C) Note 1	Capacitance Change from 25°C (%)					
		-55		-30		-10	
		Max.	Min.	Max.	Min.	Max.	Min.
5C	0±30	0.58	-0.24	0.40	-0.17	0.25	-0.11

Note 1 : Nominal values denote the temperature coefficient within a range of 25°C to 125°C.

# Chip Monolithic Ceramic Capacitors



## for Ultrasonic Sensors

### ■ Features

1. Proper compensation for ultrasonic sensors
2. Small chip size and high capacitance value

### ■ Application

Ultrasonic sensor  
 (back sonar, corner sonar, etc.)

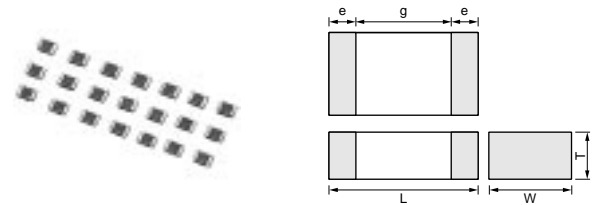

Part Number	Dimensions (mm)				
	L	W	T	e	g min.
<b>GRM219</b>	2.0 ±0.1	1.25 ±0.1	0.85 ±0.1	0.2 to 0.7	0.7

Part Number	TC Code	Rated Voltage (Vdc)	Capacitance (pF)	Length L (mm)	Width W (mm)	Thickness T (mm)
<b>GRM2199E2A102KD42</b>	ZLM (Murata)	100	1000 ±10%	2.0	1.25	0.85
<b>GRM2199E2A152KD42</b>	ZLM (Murata)	100	1500 ±10%	2.0	1.25	0.85

9

## Specifications and Test Methods

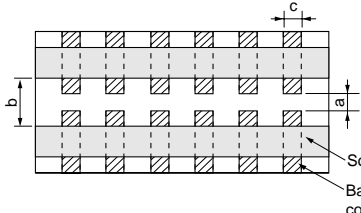
No.	Item	Specifications	Test Method												
1	Operating Temperature	-25°C to +85°C													
2	Rated Voltage	See the previous pages.	The rated voltage is defined as the maximum voltage which may be applied continuously to the capacitor. When AC voltage is superimposed on DC voltage, $V^{P-P}$ or $V^{O-P}$ , whichever is larger, should be maintained within the rated voltage range.												
3	Appearance	No defects or abnormalities	Visual inspection.												
4	Dimensions	Within the specified dimensions	Using calipers.												
5	Dielectric Strength	No defects or abnormalities	No failure should be observed when 300% of the rated voltage is applied between the terminations for 1 to 5 seconds, provided the charge/discharge current is less than 50mA.												
6	Insulation Resistance (I.R.)	More than 10,000MΩ or 500Ω • F. (Whichever is smaller)	The insulation resistance should be measured with a DC voltage not exceeding the rated voltage at 20°C and 75%RH max. and within 2 minutes of charging.												
7	Capacitance	Within the specified tolerance	The capacitance/D.F. should be measured at 20°C with 1±0.1kHz in frequency and 1±0.2Vr.m.s. in voltage.												
8	Dissipation Factor (D.F.)	0.01 max.													
9	Capacitance Temperature Characteristics	Within $-4,700 \pm 1,990$ ppm/°C (at -25 to +20°C) Within $-4,700 \pm 9,900$ ppm/°C (at +20 to +85°C)	<p>The temperature coefficient is determined using the capacitance measured in step 1 as a reference. When cycling the temperature sequentially from step 1 through 5, the capacitance should be within the specified tolerance for the temperature coefficient. The capacitance change should be measured after 5 min. at each specified temperature stage.</p> <table border="1" style="margin-left: auto; margin-right: auto;"> <thead> <tr> <th>Step</th> <th>Temperature(°C)</th> </tr> </thead> <tbody> <tr> <td>1</td> <td>20±2</td> </tr> <tr> <td>2</td> <td>-25±3</td> </tr> <tr> <td>3</td> <td>20±2</td> </tr> <tr> <td>4</td> <td>85±3</td> </tr> <tr> <td>5</td> <td>20±2</td> </tr> </tbody> </table>	Step	Temperature(°C)	1	20±2	2	-25±3	3	20±2	4	85±3	5	20±2
Step	Temperature(°C)														
1	20±2														
2	-25±3														
3	20±2														
4	85±3														
5	20±2														
10	Adhesive Strength of Termination	No removal of the terminations or other defect should occur.	<p>Solder the capacitor to the test jig (glass epoxy board) shown in Fig.1 using a eutectic solder. Then apply 10N force in the direction of the arrow. The soldering should be done either with an iron or using the reflow method and should be conducted with care so that the soldering is uniform and free of defects such as heat shock.</p> <div style="text-align: center;">  <p style="text-align: right; margin-right: 50px;">Solder resist Baked electrode or copper foil</p> <table border="1" style="margin-left: auto; margin-right: auto;"> <thead> <tr> <th>Type</th> <th>a</th> <th>b</th> <th>c</th> </tr> </thead> <tbody> <tr> <td>GRM21</td> <td>1.2</td> <td>4.0</td> <td>1.65</td> </tr> </tbody> </table> <p style="text-align: right;">(in mm)</p> </div> <p style="text-align: center;">Fig.1</p>	Type	a	b	c	GRM21	1.2	4.0	1.65				
Type	a	b	c												
GRM21	1.2	4.0	1.65												
11	Vibration Resistance	Appearance	No defects or abnormalities												
		Capacitance	Within the specified tolerance												
		D.F.	0.01 max.												
			<p>Solder the capacitor to the test jig (glass epoxy board) in the same manner and under the same conditions as (10). The capacitor should be subjected to a simple harmonic motion having a total amplitude of 1.5mm, the frequency being varied uniformly between the approximate limits of 10 and 55Hz. The frequency range, from 10 to 55Hz and return to 10Hz, should be traversed in approximately 1 minute. This motion should be applied for a period of 2 hours in each of 3 mutually perpendicular directions (total of 6 hours).</p>												

Continued on the following page.

## Specifications and Test Methods

Continued from the preceding page.

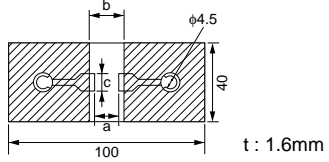
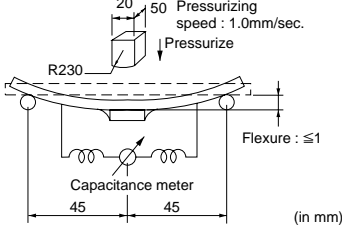
No.	Item	Specifications	Test Method															
12	Deflection	No cracking or marking defects should occur.	<p>Solder the capacitor to the test jig (glass epoxy boards) shown in Fig. 2 using a eutectic solder.</p> <p>Then apply a force in the direction shown in Fig. 3.</p> <p>The soldering should be done either with an iron or using the reflow method and should be conducted with care so that the soldering is uniform and free of defects such as heat shock.</p>															
		 <table border="1" data-bbox="370 622 880 676"> <thead> <tr> <th>Type</th> <th>a</th> <th>b</th> <th>c</th> </tr> </thead> <tbody> <tr> <td>GRM21</td> <td>1.2</td> <td>4.0</td> <td>1.65</td> </tr> </tbody> </table> <p>(in mm)</p> <p>Fig. 2</p>		Type	a	b	c	GRM21	1.2	4.0	1.65							
Type	a	b	c															
GRM21	1.2	4.0	1.65															
			 <p>(in mm)</p> <p>Fig. 3</p>															
13	Solderability of Termination	75% of the terminations are to be soldered evenly and continuously	Immerse the capacitor in a solution of ethanol (JIS-K-8101) and rosin (JIS-K-5902) (25% rosin in weight proportion). Preheat at 80 to 120°C for 10 to 30 seconds. After preheating, immerse in eutectic solder solution for 2±0.5 seconds at 230±5°C.															
14	Resistance to Soldering Heat	Appearance	No defects or abnormalities															
		Capacitance Change	Within ±7.5%															
		D.F.	0.01 max.															
		I.R.	More than 10,000MΩ or 500Ω • F (Whichever is smaller)															
		Dielectric Strength	No failure															
15	Temperature Cycle	Appearance	No defects or abnormalities															
		Capacitance Change	Within ±7.5%															
		D.F.	0.01 max.															
		I.R.	More than 10,000MΩ or 500Ω • F (Whichever is smaller)															
		Dielectric Strength	No failure															
			<table border="1" data-bbox="938 1205 1452 1294"> <thead> <tr> <th>Step</th> <th>1</th> <th>2</th> <th>3</th> <th>4</th> </tr> </thead> <tbody> <tr> <td>Temp. (°C)</td> <td>-25 ±3</td> <td>RoomTemp.</td> <td>85 ±3</td> <td>RoomTemp.</td> </tr> <tr> <td>Time (min.)</td> <td>30±3</td> <td>2 to 3</td> <td>30±3</td> <td>2 to 3</td> </tr> </tbody> </table>	Step	1	2	3	4	Temp. (°C)	-25 ±3	RoomTemp.	85 ±3	RoomTemp.	Time (min.)	30±3	2 to 3	30±3	2 to 3
Step	1	2	3	4														
Temp. (°C)	-25 ±3	RoomTemp.	85 ±3	RoomTemp.														
Time (min.)	30±3	2 to 3	30±3	2 to 3														
16	Humidity, Steady State	Appearance	No defects or abnormalities															
		Capacitance Change	Within ±12.5%															
		D.F.	0.02 max.															
		I.R.	More than 1,000MΩ or 50Ω • F (Whichever is smaller)															
		Dielectric Strength	No failure															
17	Humidity Load	Appearance	No defects or abnormalities															
		Capacitance Change	Within ±12.5%															
		D.F.	0.02 max.															
		I.R.	More than 500MΩ or 25Ω • F (Whichever is smaller)															
18	High Temperature Load	Appearance	No defects or abnormalities															
		Capacitance Change	Within ±12.5%															
		D.F.	0.02 max.															
		I.R.	More than 1,000MΩ or 50Ω • F (Whichever is smaller)															

# Chip Monolithic Ceramic Capacitors



## Low ESL

### ■ Features

1. Low ESL, good for noise reduction for high frequency
2. Small, high capacitance

### ■ Applications

1. High speed micro processors
2. High frequency digital equipment

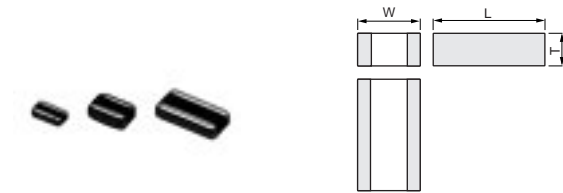

Part Number	Dimensions (mm)		
	L	W	T
<b>LLL185</b>	1.6 ±0.1	0.8 ±0.1	0.6 max.
<b>LLL216</b>	2.0 ±0.1	1.25 ±0.1	0.6 ±0.1
<b>LLL219</b>			0.85 ±0.1
<b>LLL317</b>	3.2 ±0.15	1.6 ±0.15	0.7 ±0.1
<b>LLL31M</b>			1.15 ±0.1

### LLL18 Series

Part Number	LLL18				
L x W	1.6x0.8				
TC	X7R (R7)				Y5V (F5)
Rated Volt.	50 (1H)	25 (1E)	16 (1C)	10 (1A)	25 (1E)
Capacitance (Capacitance part numbering code) and T (mm) Dimension (T Dimension part numbering code)					
2200pF(222)	0.5(5)				
3300pF(332)	0.5(5)				
4700pF(472)	0.5(5)				
6800pF(682)		0.5(5)			
10000pF(103)		0.5(5)			
15000pF(153)		0.5(5)			
22000pF(223)		0.5(5)			0.5(5)
33000pF(333)			0.5(5)		
47000pF(473)			0.5(5)		
68000pF(683)			0.5(5)		
0.10μF(104)				0.5(5)	

The part numbering code is shown in ( ).

Dimensions are shown in mm and Rated Voltage in Vdc.

### LLL21 Series

Part Number	LLL21				
L x W	2.0x1.25				
TC	X7R (R7)				
Rated Volt.	50 (1H)	25 (1E)	16 (1C)	10 (1A)	
Capacitance (Capacitance part numbering code) and T (mm) Dimension (T Dimension part numbering code)					
4700pF(472)	0.6(6)				
6800pF(682)	0.6(6)				
10000pF(103)	0.6(6)				
15000pF(153)	0.6(6)				
22000pF(223)	0.6(6)				
33000pF(333)	0.85(9)	0.6(6)	0.6(6)		
47000pF(473)		0.6(6)	0.6(6)		

Continued on the following page.

Continued from the preceding page.

Part Number	LLL21			
L x W	2.0x1.25			
TC	X7R (R7)			
Rated Volt.	50 (1H)	25 (1E)	16 (1C)	10 (1A)
Capacitance (Capacitance part numbering code) and T (mm) Dimension (T Dimension part numbering code)				
68000pF(683)		0.6(6)	0.6(6)	
0.10μF(104)		0.6(6)	0.6(6)	
0.15μF(154)		0.85(9)	0.6(6)	
0.22μF(224)			0.85(9)	0.6(6)
0.33μF(334)				0.6(6)
0.47μF(474)				0.85(9)

The part numbering code is shown in ( ).  
Dimensions are shown in mm and Rated Voltage in Vdc.

### LLL31 Series

Part Number	LLL31			
L x W	3.2x1.6			
TC	X7R (R7)			
Rated Volt.	50 (1H)	25 (1E)	16 (1C)	10 (1A)
Capacitance (Capacitance part numbering code) and T (mm) Dimension (T Dimension part numbering code)				
10000pF(103)	0.7(7)			
15000pF(153)	0.7(7)			
22000pF(223)	0.7(7)			
33000pF(333)	0.7(7)			
47000pF(473)	0.7(7)			
68000pF(683)	0.7(7)			
0.10μF(104)	1.15(M)	0.7(7)	0.7(7)	
0.15μF(154)		0.7(7)	0.7(7)	
0.22μF(224)		1.15(M)	0.7(7)	
0.33μF(334)		1.15(M)	0.7(7)	
0.47μF(474)		1.15(M)	0.7(7)	
0.68μF(684)			1.15(M)	0.7(7)
1.0μF(105)			1.15(M)	0.7(7)
1.5μF(155)				1.15(M)
2.2μF(225)				1.15(M)

The part numbering code is shown in ( ).  
Dimensions are shown in mm and Rated Voltage in Vdc.

10

## Specifications and Test Methods

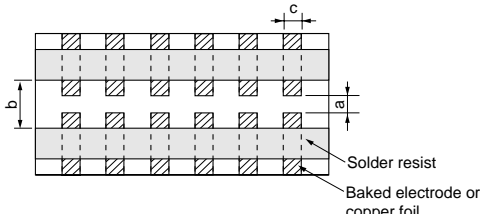
No.	Item	Specifications	Test Method																		
1	Operating Temperature Range	R7 : -55°C to +125°C F5 : -30°C to +85°C																			
2	Rated Voltage	See the previous pages.	The rated voltage is defined as the maximum voltage which may be applied continuously to the capacitor. When AC voltage is superimposed on DC voltage, $V^{P-P}$ or $V^{O-P}$ , whichever is larger, should be maintained within the rated voltage range.																		
3	Appearance	No defects or abnormalities	Visual inspection																		
4	Dimensions	Within the specified dimension	Using calipers																		
5	Dielectric Strength	No defects or abnormalities	No failure should be observed when 250% of the rated voltage is applied between the terminations for 1 to 5 seconds, provided the charge/discharge current is less than 50mA.																		
6	Insulation Resistance (I.R.)	More than 10,000MΩ or 500Ω • F (Whichever is smaller)	The insulation resistance should be measured with a DC voltage not exceeding the rated voltage at 25°C and 75%RH max. and within 2 minutes of charging.																		
7	Capacitance	Within the specified tolerance	The capacitance/D.F. should be measured at 25°C at the frequency and voltage shown in the table.																		
8	Dissipation Factor (D.F.)	<table border="1" style="width: 100%; border-collapse: collapse;"> <thead> <tr> <th>Char.</th> <th>25V min.</th> <th>16V</th> </tr> </thead> <tbody> <tr> <td>R7</td> <td>0.025 max.</td> <td>0.035 max.</td> </tr> <tr> <td>F5</td> <td>0.05 max.</td> <td>—</td> </tr> </tbody> </table>	Char.	25V min.	16V	R7	0.025 max.	0.035 max.	F5	0.05 max.	—	<table border="1" style="width: 100%; border-collapse: collapse;"> <thead> <tr> <th>Item</th> <th>Char.</th> <th>R7</th> </tr> </thead> <tbody> <tr> <td>Frequency</td> <td></td> <td>1±0.1kHz</td> </tr> <tr> <td>Voltage</td> <td></td> <td>1±0.2Vr.m.s.</td> </tr> </tbody> </table>	Item	Char.	R7	Frequency		1±0.1kHz	Voltage		1±0.2Vr.m.s.
		Char.	25V min.	16V																	
R7	0.025 max.	0.035 max.																			
F5	0.05 max.	—																			
Item	Char.	R7																			
Frequency		1±0.1kHz																			
Voltage		1±0.2Vr.m.s.																			
9	Capacitance Temperature Characteristics	<table border="1" style="width: 100%; border-collapse: collapse;"> <thead> <tr> <th>Char.</th> <th>Temp. Range (°C)</th> <th>Reference Temp.</th> <th>Cap. Change.</th> </tr> </thead> <tbody> <tr> <td>R7</td> <td>-55 to +125</td> <td>25°C</td> <td>Within±15%</td> </tr> <tr> <td>F5</td> <td>-30 to +85</td> <td>25°C</td> <td>Within+22/-82%</td> </tr> </tbody> </table>	Char.	Temp. Range (°C)	Reference Temp.	Cap. Change.	R7	-55 to +125	25°C	Within±15%	F5	-30 to +85	25°C	Within+22/-82%	The ranges of capacitance change compared with the 25°C value over the temperature ranges shown in the table should be within the specified ranges. The capacitance change should be measured after 5 min. at each specified temperature stage.						
Char.	Temp. Range (°C)	Reference Temp.	Cap. Change.																		
R7	-55 to +125	25°C	Within±15%																		
F5	-30 to +85	25°C	Within+22/-82%																		
10	Adhesive Strength of Termination	No removal of the terminations or other defect should occur.	<p>Solder the capacitor to the test jig (glass epoxy board) shown in Fig. 1 using a eutectic solder. Then apply 10N* force in the direction of the arrow. *5N: LLL18 The soldering should be done either with an iron or using the reflow method and should be conducted with care so that the soldering is uniform and free of defects such as heat shock.</p>  <table border="1" style="width: 100%; border-collapse: collapse; margin-top: 10px;"> <thead> <tr> <th>Type</th> <th>a</th> <th>b</th> <th>c</th> </tr> </thead> <tbody> <tr> <td>LLL18</td> <td>0.3</td> <td>1.2</td> <td>2.0</td> </tr> <tr> <td>LLL21</td> <td>0.6</td> <td>1.6</td> <td>2.4</td> </tr> <tr> <td>LLL31</td> <td>1.0</td> <td>3.0</td> <td>3.7</td> </tr> </tbody> </table> <p style="text-align: right;">(in mm)</p> <p style="text-align: center;">Fig. 1</p>	Type	a	b	c	LLL18	0.3	1.2	2.0	LLL21	0.6	1.6	2.4	LLL31	1.0	3.0	3.7		
Type	a	b	c																		
LLL18	0.3	1.2	2.0																		
LLL21	0.6	1.6	2.4																		
LLL31	1.0	3.0	3.7																		
11	Vibration Resistance	Appearance	No defects or abnormalities																		
		Capacitance	Within the specified tolerance																		
		D.F.	<table border="1" style="width: 100%; border-collapse: collapse;"> <thead> <tr> <th>Char.</th> <th>25V min.</th> <th>16V</th> </tr> </thead> <tbody> <tr> <td>R7</td> <td>0.025 max.</td> <td>0.035 max.</td> </tr> <tr> <td>F5</td> <td>0.05 max.</td> <td>—</td> </tr> </tbody> </table>	Char.	25V min.	16V	R7	0.025 max.	0.035 max.	F5	0.05 max.	—									
Char.	25V min.	16V																			
R7	0.025 max.	0.035 max.																			
F5	0.05 max.	—																			
			<p>Solder the capacitor to the test jig (glass epoxy board) in the same manner and under the same conditions as (10). The capacitor should be subjected to a simple harmonic motion having a total amplitude of 1.5mm, the frequency being varied uniformly between the approximate limits of 10 and 55Hz. The frequency range, from 10 to 55Hz and return to 10Hz, should be traversed in approximately 1 minute. This motion should be applied for a period of 2 hours in each of 3 mutually perpendicular directions (total of 6 hours).</p>																		

Continued on the following page.

10

## Specifications and Test Methods

Continued from the preceding page.

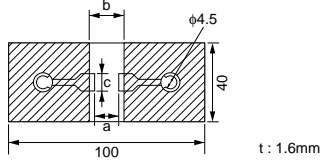
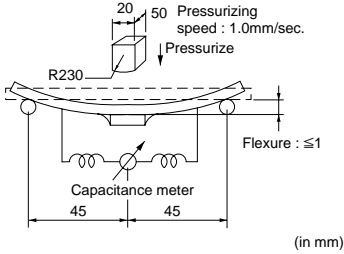
No.	Item	Specifications	Test Method															
12	Deflection	No crack or marked defect should occur.	<p>Solder the capacitor to the test jig (glass epoxy boards) shown in Fig. 2 using a eutectic solder.</p> <p>Then apply a force in the direction shown in Fig. 3.</p> <p>The soldering should be done either with an iron or using the reflow method and should be conducted with care so that the soldering is uniform and free of defects such as heat shock.</p>															
		 <table border="1" data-bbox="370 622 880 725"> <thead> <tr> <th>Type</th> <th>a</th> <th>b</th> <th>c</th> </tr> </thead> <tbody> <tr> <td>LLL18</td> <td>0.3</td> <td>1.2</td> <td>2.0</td> </tr> <tr> <td>LLL21</td> <td>0.6</td> <td>1.6</td> <td>2.4</td> </tr> <tr> <td>LLL31</td> <td>1.0</td> <td>3.0</td> <td>3.7</td> </tr> </tbody> </table> <p style="text-align: right;">(in mm)</p>		Type	a	b	c	LLL18	0.3	1.2	2.0	LLL21	0.6	1.6	2.4	LLL31	1.0	3.0
Type	a	b	c															
LLL18	0.3	1.2	2.0															
LLL21	0.6	1.6	2.4															
LLL31	1.0	3.0	3.7															
		Fig. 2	 <p style="text-align: right;">(in mm)</p> <p style="text-align: center;">Fig. 3</p>															
13	Solderability of Termination	75% of the terminations are to be soldered evenly and continuously.	Immerse the capacitor in a solution of ethanol (JIS-K-8101) and rosin (JIS-K-5902) (25% rosin in weight proportion). Preheat at 80 to 120°C for 10 to 30 seconds. After preheating, immerse in eutectic solder solution for 2±0.5 seconds at 230±5°C.															
14	Resistance to Soldering Heat	Appearance	No defects or abnormalities															
		Capacitance Change	R7 : Within±7.5% F5 : Within±20%															
		D.F.	<table border="1" data-bbox="370 996 880 1077"> <thead> <tr> <th>Char.</th> <th>25V min.</th> <th>16V</th> </tr> </thead> <tbody> <tr> <td>R7</td> <td>0.025 max.</td> <td>0.035 max.</td> </tr> <tr> <td>F5</td> <td>0.05 max.</td> <td>—</td> </tr> </tbody> </table>	Char.	25V min.	16V	R7	0.025 max.	0.035 max.	F5	0.05 max.	—						
		Char.	25V min.	16V														
		R7	0.025 max.	0.035 max.														
F5	0.05 max.	—																
I.R.	More than 10,000MΩ or 500Ω • F (Whichever is smaller)																	
Dielectric Strength	No failure																	
			<p>Preheat the capacitor at 120 to 150°C for 1 minute. Immerse the capacitor in a eutectic solder solution at 270±5°C for 10±0.5 seconds. Let sit at room temperature for 48±4 hours, then measure.</p> <p>•Initial measurement.</p> <p>Perform a heat treatment at 150±5°C for one hour and then let sit for 48±4 hours at room temperature. Perform the initial measurement.</p>															
15	Temperature Cycle	Appearance	No defects or abnormalities															
		Capacitance Change	R7 : Within±7.5% F5 : Within±20%															
		D.F.	<table border="1" data-bbox="370 1288 880 1368"> <thead> <tr> <th>Char.</th> <th>25V min.</th> <th>16V</th> </tr> </thead> <tbody> <tr> <td>R7</td> <td>0.025 max.</td> <td>0.035 max.</td> </tr> <tr> <td>F5</td> <td>0.05 max.</td> <td>—</td> </tr> </tbody> </table>	Char.	25V min.	16V	R7	0.025 max.	0.035 max.	F5	0.05 max.	—						
		Char.	25V min.	16V														
		R7	0.025 max.	0.035 max.														
F5	0.05 max.	—																
I.R.	More than 10,000MΩ or 500Ω • F (Whichever is smaller)																	
Dielectric Strength	No failure																	
			<p>Fix the capacitor to the supporting jig in the same manner and under the same conditions as (10).</p> <p>Perform the five cycles according to the four heat treatments listed in the following table. Let sit for 48±4 hours at room temperature, then measure.</p> <table border="1" data-bbox="938 1317 1452 1429"> <thead> <tr> <th>Step</th> <th>1</th> <th>2</th> <th>3</th> <th>4</th> </tr> </thead> <tbody> <tr> <td>Temp. (°C)</td> <td>Min. Operating Temp. ±5</td> <td>Room Temp.</td> <td>Max. Operating Temp. ±3</td> <td>Room Temp.</td> </tr> <tr> <td>Time (min.)</td> <td>30±3</td> <td>2 to 3</td> <td>30±3</td> <td>2 to 3</td> </tr> </tbody> </table> <p>•Initial measurement.</p> <p>Perform a heat treatment at 150±5°C for one hour and then let sit for 48±4 hours at room temperature. Perform the initial measurement.</p>	Step	1	2	3	4	Temp. (°C)	Min. Operating Temp. ±5	Room Temp.	Max. Operating Temp. ±3	Room Temp.	Time (min.)	30±3	2 to 3	30±3	2 to 3
Step	1	2	3	4														
Temp. (°C)	Min. Operating Temp. ±5	Room Temp.	Max. Operating Temp. ±3	Room Temp.														
Time (min.)	30±3	2 to 3	30±3	2 to 3														
16	Humidity, Steady State	Appearance	No defects or abnormalities															
		Capacitance Change	R7 : Within±12.5% F5 : Within±30%															
		D.F.	<table border="1" data-bbox="370 1646 880 1727"> <thead> <tr> <th>Char.</th> <th>25V min.</th> <th>16V</th> </tr> </thead> <tbody> <tr> <td>R7</td> <td>0.05 max.</td> <td>0.05 max.</td> </tr> <tr> <td>F5</td> <td>0.075 max.</td> <td>—</td> </tr> </tbody> </table>	Char.	25V min.	16V	R7	0.05 max.	0.05 max.	F5	0.075 max.	—						
		Char.	25V min.	16V														
R7	0.05 max.	0.05 max.																
F5	0.075 max.	—																
I.R.	More than 1,000MΩ or 50Ω • F (Whichever is smaller)																	
			<p>Let the capacitor sit at 40±2°C and 90 to 95% humidity for 500±12 hours.</p> <p>Remove and let sit for 48±4 hours at room temperature, then measure.</p>															
17	Humidity Load	Appearance	No defects or abnormalities															
		Capacitance Change	R7 : Within±12.5% F5 : Within±30%															
		D.F.	<table border="1" data-bbox="370 1870 880 1951"> <thead> <tr> <th>Char.</th> <th>25V min.</th> <th>16V</th> </tr> </thead> <tbody> <tr> <td>R7</td> <td>0.05 max.</td> <td>0.05 max.</td> </tr> <tr> <td>F5</td> <td>0.075 max.</td> <td>—</td> </tr> </tbody> </table>	Char.	25V min.	16V	R7	0.05 max.	0.05 max.	F5	0.075 max.	—						
		Char.	25V min.	16V														
R7	0.05 max.	0.05 max.																
F5	0.075 max.	—																
I.R.	More than 500MΩ or 25Ω • F (Whichever is smaller)																	
		Dielectric Strength	No failure															
			<p>Apply the rated voltage at 40±2°C and 90 to 95% humidity for 500±12 hours. Remove and let sit for 48±4 hours at room temperature, then measure. The charge/discharge current is less than 50mA.</p>															

Continued on the following page. 



## Specifications and Test Methods

☐ Continued from the preceding page.

No.	Item	Specifications	Test Method									
18	High Temperature Load	Appearance	Apply 200% of the rated voltage for 1,000±12 hours at maximum operating temperature ±3°C. Let sit for 48±4 hours at room temperature, then measure. The charge/discharge current is less than 50mA.  •Initial measurement. Apply 200% of the rated DC voltage for one hour at the maximum operating temperature ±3°C. Remove and let sit for 48±4 hours at room temperature. Perform initial measurement.									
	Capacitance Change	R7 : Within±12.5% F5 : Within±30%										
	D.F.	<table border="1" style="width: 100%; border-collapse: collapse;"> <thead> <tr> <th style="text-align: center;">Char.</th> <th style="text-align: center;">25V min.</th> <th style="text-align: center;">16V</th> </tr> </thead> <tbody> <tr> <td style="text-align: center;">R7</td> <td style="text-align: center;">0.05 max.</td> <td style="text-align: center;">0.05 max.</td> </tr> <tr> <td style="text-align: center;">F5</td> <td style="text-align: center;">0.075 max.</td> <td style="text-align: center;">—</td> </tr> </tbody> </table>		Char.	25V min.	16V	R7	0.05 max.	0.05 max.	F5	0.075 max.	—
	Char.	25V min.		16V								
	R7	0.05 max.		0.05 max.								
F5	0.075 max.	—										
I.R.	More than 1,000MΩ or 50Ω • F (Whichever is smaller)											
Dielectric Strength	No failure											

# Chip Monolithic Ceramic Capacitors



## High Frequency for Flow/Reflow Soldering

### ■ Features

1. HiQ and low ESR at VHF, UHF, Microwave
2. Feature improvement, low power consumption for mobile telecommunication. (Base station, terminal, etc.)

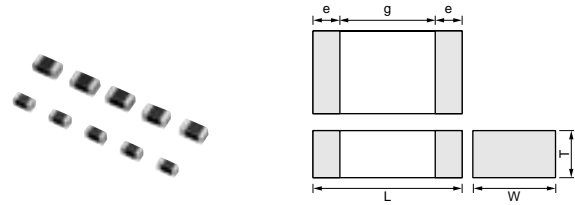

### ■ Applications

High frequency circuit (Mobile telecommunication, etc.)

Part Number	Dimensions (mm)				
	L	W	T	e	g min.
<b>GQM188</b>	1.6 ±0.1	0.8 ±0.1	0.8 ±0.1	0.2 to 0.5	0.5
<b>GQM219</b>	2.0 ±0.1	1.25 ±0.1	0.85 ±0.1	0.2 to 0.7	0.7

Part Number	<b>GQM18</b>		<b>GQM21</b>	
	1.60x0.80		2.00x1.25	
L x W	1.60x0.80		2.00x1.25	
TC	COG (5C)		COG (5C)	
Rated Volt.	100 (2A)	50 (1H)	100 (2A)	50 (1H)
Capacitance (Capacitance part numbering code) and T (mm) Dimension (T Dimension part numbering code)				
0.50pF( <b>R50</b> )	0.80( <b>8</b> )		0.85( <b>9</b> )	
0.75pF( <b>R75</b> )	0.80( <b>8</b> )		0.85( <b>9</b> )	
1.0pF( <b>1R0</b> )	0.80( <b>8</b> )		0.85( <b>9</b> )	
1.1pF( <b>1R1</b> )	0.80( <b>8</b> )		0.85( <b>9</b> )	
1.2pF( <b>1R2</b> )	0.80( <b>8</b> )		0.85( <b>9</b> )	
1.3pF( <b>1R3</b> )	0.80( <b>8</b> )		0.85( <b>9</b> )	
1.5pF( <b>1R5</b> )	0.80( <b>8</b> )		0.85( <b>9</b> )	
1.6pF( <b>1R6</b> )	0.80( <b>8</b> )		0.85( <b>9</b> )	
1.8pF( <b>1R8</b> )	0.80( <b>8</b> )		0.85( <b>9</b> )	
2.0pF( <b>2R0</b> )	0.80( <b>8</b> )		0.85( <b>9</b> )	
2.2pF( <b>2R2</b> )	0.80( <b>8</b> )		0.85( <b>9</b> )	
2.4pF( <b>2R4</b> )	0.80( <b>8</b> )		0.85( <b>9</b> )	
2.7pF( <b>2R7</b> )	0.80( <b>8</b> )		0.85( <b>9</b> )	
3.0pF( <b>3R0</b> )	0.80( <b>8</b> )		0.85( <b>9</b> )	
3.3pF( <b>3R3</b> )	0.80( <b>8</b> )		0.85( <b>9</b> )	
3.6pF( <b>3R6</b> )	0.80( <b>8</b> )		0.85( <b>9</b> )	
3.9pF( <b>3R9</b> )	0.80( <b>8</b> )		0.85( <b>9</b> )	
4.0pF( <b>4R0</b> )	0.80( <b>8</b> )		0.85( <b>9</b> )	
4.3pF( <b>4R3</b> )	0.80( <b>8</b> )		0.85( <b>9</b> )	
4.7pF( <b>4R7</b> )	0.80( <b>8</b> )		0.85( <b>9</b> )	
5.0pF( <b>5R0</b> )	0.80( <b>8</b> )		0.85( <b>9</b> )	
5.1pF( <b>5R1</b> )	0.80( <b>8</b> )		0.85( <b>9</b> )	
5.6pF( <b>5R6</b> )	0.80( <b>8</b> )		0.85( <b>9</b> )	
6.0pF( <b>6R0</b> )	0.80( <b>8</b> )		0.85( <b>9</b> )	
6.2pF( <b>6R2</b> )	0.80( <b>8</b> )		0.85( <b>9</b> )	
6.8pF( <b>6R8</b> )	0.80( <b>8</b> )		0.85( <b>9</b> )	
7.0pF( <b>7R0</b> )		0.80( <b>8</b> )	0.85( <b>9</b> )	
7.5pF( <b>7R5</b> )		0.80( <b>8</b> )	0.85( <b>9</b> )	
8.0pF( <b>8R0</b> )		0.80( <b>8</b> )	0.85( <b>9</b> )	
8.2pF( <b>8R2</b> )		0.80( <b>8</b> )	0.85( <b>9</b> )	
9.0pF( <b>9R0</b> )		0.80( <b>8</b> )	0.85( <b>9</b> )	
9.1pF( <b>9R1</b> )		0.80( <b>8</b> )	0.85( <b>9</b> )	
10pF( <b>100</b> )		0.80( <b>8</b> )	0.85( <b>9</b> )	

Continued on the following page.

Continued from the preceding page.

Part Number	GQM18		GQM21	
L x W	1.60x0.80		2.00x1.25	
TC	COG (5C)		COG (5C)	
Rated Volt.	100 (2A)	50 (1H)	100 (2A)	50 (1H)
Capacitance (Capacitance part numbering code) and T (mm) Dimension (T Dimension part numbering code)				
11pF(110)		0.80(8)	0.85(9)	
12pF(120)		0.80(8)	0.85(9)	
13pF(130)		0.80(8)	0.85(9)	
15pF(150)		0.80(8)	0.85(9)	
16pF(160)		0.80(8)	0.85(9)	
18pF(180)		0.80(8)	0.85(9)	
20pF(200)		0.80(8)		0.85(9)
22pF(220)		0.80(8)		0.85(9)
24pF(240)		0.80(8)		0.85(9)
27pF(270)				0.85(9)
30pF(300)				0.85(9)
33pF(330)				0.85(9)
36pF(360)				0.85(9)
39pF(390)				0.85(9)
43pF(430)				0.85(9)
47pF(470)				0.85(9)

The part numbering code is shown in ( ).  
Dimensions are shown in mm and Rated Voltage in Vdc.

### ■ Q-Frequency Characteristics

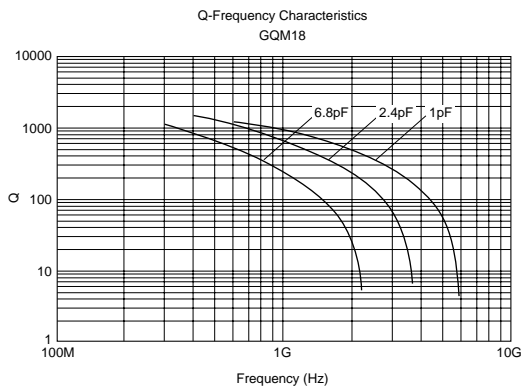

### ■ Resonant Frequency-Capacitance

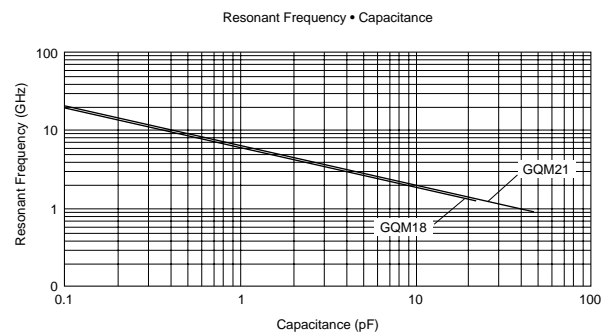

11

## Specifications and Test Methods

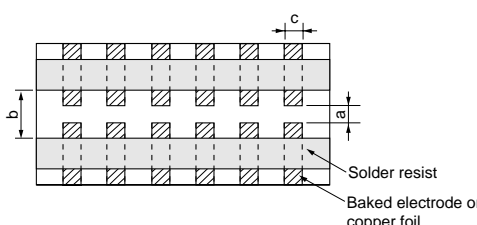
No.	Item	Specifications	Test Method									
1	Operating Temperature	5C : -55°C to 125°C										
2	Rated Voltage	See the previous page.	The rated voltage is defined as the maximum voltage which may be applied continuously to the capacitor. When AC voltage is superimposed on DC voltage, $V^{P-P}$ or $V^{O-P}$ , whichever is larger, should be maintained within the rated voltage range.									
3	Appearance	No defects or abnormalities	Visual inspection									
4	Dimension	Within the specified dimensions	Using calipers									
5	Dielectric Strength	No defects or abnormalities	No failure should be observed when 300% of the rated voltage is applied between the terminations for 1 to 5 seconds, provided the charge/discharge current is less than 50mA.									
6	Insulation Resistance	More than 10,000MΩ or 500Ω • F (whichever is smaller)	The insulation resistance should be measured with a DC voltage not exceeding the rated voltage at 25°C and 75%RH max. and within 2 minutes of charging.									
7	Capacitance	Within the specified tolerance	The capacitance/Q should be measured at 25°C at the frequency and voltage shown in the table.									
8	Q	30pF min. : $Q \geq 1000$ 30pF max. : $Q \geq 400+20C$ C : Nominal Capacitance (pF)	<table border="1" style="width: 100%; border-collapse: collapse;"> <thead> <tr> <th style="width: 15%;">Item</th> <th style="width: 15%;">Char.</th> <th style="width: 70%;">5C (1000pF and below)</th> </tr> </thead> <tbody> <tr> <td>Frequency</td> <td></td> <td>1±0.1MHz</td> </tr> <tr> <td>Voltage</td> <td></td> <td>0.5 to 5Vrms</td> </tr> </tbody> </table>	Item	Char.	5C (1000pF and below)	Frequency		1±0.1MHz	Voltage		0.5 to 5Vrms
		Item	Char.	5C (1000pF and below)								
Frequency		1±0.1MHz										
Voltage		0.5 to 5Vrms										
9	Capacitance Temperature Characteristics	Capacitance Change Within the specified tolerance (Table A)	The temperature coefficient is determined using the capacitance measured in step 3 as a reference. When cycling the temperature sequentially from step 1 through 5 the capacitance should be within the specified tolerance for the temperature coefficient and capacitance change as in Table A. The capacitance drift is calculated by dividing the differences between the maximum and minimum measured values in the steps 1, 3 and 5 by the capacitance. value in step 3.									
		Temperature Coefficient Within the specified tolerance (Table A)										
		Capacitance Drift Within ±0.2% or ±0.05pF (Whichever is larger.)										
10	Adhesive Strength of Termination	No removal of the terminations or other defect should occur.	Solder the capacitor to the test jig (glass epoxy board) shown in Fig. 1 using a eutectic solder. Then apply 10N* force in parallel with the test jig for 10±1sec. The soldering should be done either with an iron or using the reflow method and should be conducted with care so that the soldering is uniform and free of defects such as heat shock. *5N (GQM188)									
												
11	Vibration Resistance	Appearance No defects or abnormalities	Solder the capacitor to the test jig (glass epoxy board) in the same manner and under the same conditions as (10). The capacitor should be subjected to a simple harmonic motion having a total amplitude of 1.5mm, the frequency being varied uniformly between the approximate limits of 10 and 55Hz. The frequency range, from 10 to 55Hz and return to 10Hz, should be traversed in approximately 1 minute. This motion should be applied for a period of 2 hours in each of 3 mutually perpendicular directions (total of 6 hours).									
		Capacitance Within the specified tolerance										
		Q 30pF min. : $Q \geq 1000$ 30pF max. : $Q \geq 400+20C$ C : Nominal Capacitance (pF)										

Type	a	b	c
GQM18	1.0	3.0	1.2
GQM21	1.2	4.0	1.65
GQM32	2.2	5.0	2.9

(in mm)  
Fig. 1

Continued on the following page.

## Specifications and Test Methods

Continued from the preceding page.

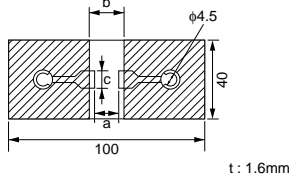
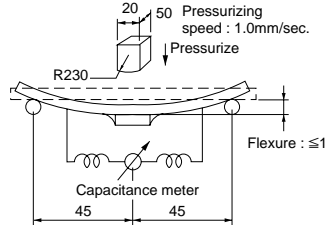
No.	Item	Specifications	Test Method															
12	Deflection	No crack or marked defect should occur.	<p>Solder the capacitor on the test jig (glass epoxy board) shown in Fig. 2 using a eutectic solder.</p> <p>Then apply a force in the direction shown in Fig. 3.</p> <p>The soldering should be done either with an iron or using the reflow method and should be conducted with care so that the soldering is uniform and free of defects such as heat shock.</p>															
		 <table border="1" style="margin: 10px auto; border-collapse: collapse;"> <thead> <tr> <th>Type</th> <th>a</th> <th>b</th> <th>c</th> </tr> </thead> <tbody> <tr> <td>GQM18</td> <td>1.0</td> <td>3.0</td> <td>1.2</td> </tr> <tr> <td>GQM21</td> <td>1.2</td> <td>4.0</td> <td>1.65</td> </tr> <tr> <td>GQM32</td> <td>2.2</td> <td>5.0</td> <td>2.9</td> </tr> </tbody> </table> <p style="text-align: center;">(in mm)</p>		Type	a	b	c	GQM18	1.0	3.0	1.2	GQM21	1.2	4.0	1.65	GQM32	2.2	5.0
Type	a	b	c															
GQM18	1.0	3.0	1.2															
GQM21	1.2	4.0	1.65															
GQM32	2.2	5.0	2.9															
		Fig. 2	 <p style="text-align: center;">Fig. 3</p>															
13	Solderability of Termination	75% of the terminations are to be soldered evenly and continuously.	Immerse the capacitor in a solution of ethanol (JIS-K-8101) and rosin (JIS-K-5902) (25% rosin in weight proportion). Preheat at 80 to 120°C for 10 to 30 seconds. After preheating, immerse in eutectic solder solution for 2±0.5 seconds at 230±5°C.															
14	Resistance to Soldering Heat	The measured and observed characteristics should satisfy the specifications in the following table.	<p>Preheat the capacitor at 120 to 150°C for 1 minute. Immerse the capacitor in a eutectic solder solution at 270±5°C for 10±0.5 seconds. Let sit at room temperature for 24±2 hours.</p>															
		Appearance		No marking defects														
		Capacitance Change		Within ±2.5% or ±0.25 pF (Whichever is larger)														
		Q		30pF min. : Q ≥ 1000 30pF max. : Q ≥ 400+20C  C : Nominal Capacitance (pF)														
		I.R.		More than 10,000MΩ or 500Ω • F (Whichever is smaller)														
	Dielectric Strength	No failure																
15	Temperature Cycle	The measured and observed characteristics should satisfy the specifications in the following table.	<p>Fix the capacitor to the supporting jig in the same manner and under the same conditions as (10). Perform the five cycles according to the four heat treatments listed in the following table.</p> <p>Let sit for 24±2 hours at room temperature, then measure.</p> <table border="1" style="margin: 10px auto; border-collapse: collapse;"> <thead> <tr> <th>Step</th> <th>1</th> <th>2</th> <th>3</th> <th>4</th> </tr> </thead> <tbody> <tr> <td>Temp. (°C)</td> <td>Min. Operating Temp. +0/-3</td> <td>Room Temp.</td> <td>Max. operating Temp. +3/-0</td> <td>Room Temp.</td> </tr> <tr> <td>Time (min.)</td> <td>30±3</td> <td>2 to 3</td> <td>30±3</td> <td>2 to 3</td> </tr> </tbody> </table>	Step	1	2	3	4	Temp. (°C)	Min. Operating Temp. +0/-3	Room Temp.	Max. operating Temp. +3/-0	Room Temp.	Time (min.)	30±3	2 to 3	30±3	2 to 3
		Step		1	2	3	4											
		Temp. (°C)		Min. Operating Temp. +0/-3	Room Temp.	Max. operating Temp. +3/-0	Room Temp.											
		Time (min.)		30±3	2 to 3	30±3	2 to 3											
		Appearance		No marking defects														
Capacitance Change	Within ±2.5% or ±0.25pF (Whichever is larger)																	
Q	30pF min. : Q ≥ 1000 30pF max. : Q ≥ 400+20C  C : Nominal Capacitance (pF)																	
I.R.	More than 10,000MΩ or 500Ω • F (Whichever is smaller)																	
	Dielectric Strength	No failure																
16	Humidity Steady State	The measured and observed characteristics should satisfy the specifications in the following table.	<p>Let the capacitor sit at 40±2°C and 90 to 95% humidity for 500±12 hours. Remove and let sit for 24±2 hours (temperature compensating type) at room temperature, then measure.</p>															
		Appearance		No marking defects														
		Capacitance Change		Within ±5% or ±0.5pF (Whichever is larger)														
		Q		30pF min. : Q ≥ 350 10pF and over, 30pF and below : Q ≥ 275+5C/2 10pF max. : Q ≥ 200+10C  C : Nominal Capacitance (pF)														
		I.R.		More than 1,000MΩ or 50Ω • F (Whichever is smaller)														
	Dielectric Strength	No failure																

Continued on the following page. ↗

## Specifications and Test Methods

Continued from the preceding page.

No.	Item	Specifications	Test Method	
17	Humidity Load	The measured and observed characteristics should satisfy the specifications in the following table.	Apply the rated voltage at 40±2°C and 90 to 95% humidity for 500±12 hours. Remove and let sit for 24±2 hours at room temperature then measure. The charge/discharge current is less than 50mA.	
		Appearance		No marking defects
		Capacitance Change		Within ±7.5% or ±0.75pF (Whichever is larger)
		Q		30pF min. : $Q \geq 200$ 30pF max. : $Q \geq 100 + 10C/3$ C : Nominal Capacitance (pF)
		I.R.		More than 500MΩ or 25Ω • F (Whichever is smaller)
	Dielectric Strength	No failure		
18	High Temperature Load	The measured and observed characteristics should satisfy the specifications in the following table.	Apply 200% of the rated voltage for 1000±12 hours at the maximum operating temperature ±3°C. Let sit for 24±2 hours (temperature compensating type) at room temperature, then measure. The charge/discharge current is less than 50mA.	
		Appearance		No marking defects
		Capacitance Change		Within ±3% or ±0.3pF (Whichever is larger)
		Q		30pF min. : $Q \geq 350$ 10pF and over, 30pF and below : $Q \geq 275 + 5C/2$ 10pF max. : $Q \geq 200 + 10C$ C : Nominal Capacitance (pF)
		I.R.		More than 1,000MΩ or 50Ω • F (Whichever is smaller)
	Dielectric Strength	No failure		

11

Table A

Char.	Nominal Values (ppm/°C) Note 1	Capacitance Change from 25°C (%)					
		-55		-30		-10	
		Max.	Min.	Max.	Min.	Max.	Min.
5C	0±30	0.58	-0.24	0.40	-0.17	0.25	-0.11

Note1 : Nominal values denote the temperature coefficient within a range of 25°C to 125°C (for 5C)

# Chip Monolithic Ceramic Capacitors



## High-Q & High Power Type

### SMD Type

#### ■ Features (ERF Series)

1. The dielectric is composed of low dielectric loss ceramic. This series is perfectly suited to high frequency applications (VHS-microwave band).
2. The series is ultraminiature, yet has a high-power capacity. This is the best capacitor available for transmitter and amplifier circuits such as those in broadcasting equipment and mobile base stations.
3. ERF1D type is designed for both flow and reflow soldering and ERF22 type is designed for reflow soldering.

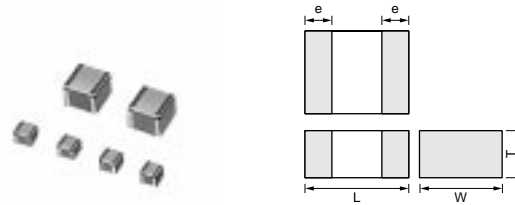

Part Number	Dimensions (mm)			
	L	W	T	e
<b>ERF1DM</b>	1.4 <sup>+0.6</sup> <sub>-0.4</sub>	1.4 <sup>+0.6</sup> <sub>-0.4</sub>	1.15 <sup>+0.50</sup> <sub>-0.35</sub>	0.25 <sup>+0.25</sup> <sub>-0.15</sub>
<b>ERF22X</b>	2.8 <sup>+0.6</sup> <sub>-0.4</sub>	2.8 <sup>+0.6</sup> <sub>-0.4</sub>	2.3 <sup>+0.5</sup> <sub>-0.3</sub>	0.4 <sup>+0.4</sup> <sub>-0.3</sub>

#### ■ Applications

High frequency and high power circuits

Part Number	ERF1D		ERF22									
	1.40x1.40		2.80x2.80									
TC	COG (5C)	CH (6C)	COG (5C)					CH (6C)				
Rated Volt.	50 (1H)	50 (1H)	500 (2H)	300 (YD)	200 (2D)	100 (2A)	50 (1H)	500 (2H)	300 (YD)	200 (2D)	100 (2A)	50 (1H)
Capacitance (Capacitance part numbering code) and T (mm) Dimension (T Dimension part numbering code)												
0.50pF(R50)	1.15(M)	1.15(M)	2.30(X)					2.30(X)				
0.6pF(R60)	1.15(M)		2.30(X)									
0.7pF(R70)	1.15(M)		2.30(X)									
0.75pF(R75)		1.15(M)						2.30(X)				
0.8pF(R80)	1.15(M)		2.30(X)									
0.9pF(R90)	1.15(M)		2.30(X)									
1.0pF(1R0)	1.15(M)	1.15(M)	2.30(X)					2.30(X)				
1.1pF(1R1)	1.15(M)		2.30(X)									
1.2pF(1R2)	1.15(M)		2.30(X)									
1.3pF(1R3)	1.15(M)		2.30(X)									
1.4pF(1R4)	1.15(M)		2.30(X)									
1.5pF(1R5)	1.15(M)	1.15(M)	2.30(X)					2.30(X)				
1.6pF(1R6)	1.15(M)		2.30(X)									
1.7pF(1R7)	1.15(M)		2.30(X)									
1.8pF(1R8)	1.15(M)		2.30(X)									
1.9pF(1R9)	1.15(M)		2.30(X)									
2.0pF(2R0)	1.15(M)	1.15(M)	2.30(X)					2.30(X)				
2.1pF(2R1)	1.15(M)		2.30(X)									
2.2pF(2R2)	1.15(M)		2.30(X)									
2.4pF(2R4)	1.15(M)		2.30(X)									
2.7pF(2R7)	1.15(M)		2.30(X)									
3.0pF(3R0)	1.15(M)	1.15(M)	2.30(X)					2.30(X)				
3.3pF(3R3)	1.15(M)		2.30(X)									
3.6pF(3R6)	1.15(M)		2.30(X)									
3.9pF(3R9)	1.15(M)		2.30(X)									
4.0pF(4R0)		1.15(M)						2.30(X)				
4.3pF(4R3)	1.15(M)		2.30(X)									
4.7pF(4R7)	1.15(M)		2.30(X)									

Continued on the following page.

Continued from the preceding page.

Part Number	ERF1D		ERF22									
L x W	1.40x1.40		2.80x2.80									
TC	COG (5C)	CH (6C)	COG (5C)					CH (6C)				
Rated Volt.	50 (1H)	50 (1H)	500 (2H)	300 (YD)	200 (2D)	100 (2A)	50 (1H)	500 (2H)	300 (YD)	200 (2D)	100 (2A)	50 (1H)
Capacitance (Capacitance part numbering code) and T (mm) Dimension (T Dimension part numbering code)												
5.0pF(5R0)		1.15(M)						2.30(X)				
5.1pF(5R1)	1.15(M)		2.30(X)									
5.6pF(5R6)	1.15(M)		2.30(X)									
6.0pF(6R0)		1.15(M)						2.30(X)				
6.2pF(6R2)	1.15(M)		2.30(X)									
6.8pF(6R8)	1.15(M)		2.30(X)									
7.0pF(7R0)		1.15(M)						2.30(X)				
7.5pF(7R5)	1.15(M)		2.30(X)									
8.0pF(8R0)		1.15(M)						2.30(X)				
8.2pF(8R2)	1.15(M)		2.30(X)									
9.0pF(9R0)		1.15(M)						2.30(X)				
9.1pF(9R1)	1.15(M)		2.30(X)									
10pF(100)	1.15(M)	1.15(M)	2.30(X)					2.30(X)				
11pF(110)	1.15(M)	1.15(M)	2.30(X)					2.30(X)				
12pF(120)	1.15(M)	1.15(M)	2.30(X)					2.30(X)				
13pF(130)	1.15(M)	1.15(M)	2.30(X)					2.30(X)				
15pF(150)	1.15(M)	1.15(M)	2.30(X)					2.30(X)				
16pF(160)	1.15(M)	1.15(M)	2.30(X)					2.30(X)				
18pF(180)	1.15(M)	1.15(M)	2.30(X)					2.30(X)				
20pF(200)	1.15(M)	1.15(M)	2.30(X)					2.30(X)				
22pF(220)	1.15(M)	1.15(M)	2.30(X)					2.30(X)				
24pF(240)	1.15(M)	1.15(M)	2.30(X)					2.30(X)				
27pF(270)	1.15(M)	1.15(M)	2.30(X)					2.30(X)				
30pF(300)	1.15(M)	1.15(M)	2.30(X)					2.30(X)				
33pF(330)	1.15(M)	1.15(M)	2.30(X)					2.30(X)				
36pF(360)	1.15(M)	1.15(M)	2.30(X)					2.30(X)				
39pF(390)	1.15(M)	1.15(M)	2.30(X)					2.30(X)				
43pF(430)	1.15(M)	1.15(M)	2.30(X)					2.30(X)				
47pF(470)	1.15(M)	1.15(M)	2.30(X)					2.30(X)				
51pF(510)	1.15(M)	1.15(M)	2.30(X)					2.30(X)				
56pF(560)	1.15(M)	1.15(M)	2.30(X)					2.30(X)				
62pF(620)	1.15(M)	1.15(M)	2.30(X)					2.30(X)				
68pF(680)	1.15(M)	1.15(M)	2.30(X)					2.30(X)				
75pF(750)	1.15(M)	1.15(M)	2.30(X)					2.30(X)				
82pF(820)	1.15(M)	1.15(M)	2.30(X)					2.30(X)				
91pF(910)	1.15(M)	1.15(M)	2.30(X)					2.30(X)				
100pF(101)	1.15(M)	1.15(M)	2.30(X)					2.30(X)				
110pF(111)				2.30(X)					2.30(X)			
120pF(121)				2.30(X)					2.30(X)			
130pF(131)				2.30(X)					2.30(X)			
150pF(151)				2.30(X)					2.30(X)			
160pF(161)				2.30(X)					2.30(X)			
180pF(181)				2.30(X)					2.30(X)			
200pF(201)				2.30(X)					2.30(X)			
220pF(221)					2.30(X)					2.30(X)		
240pF(241)					2.30(X)					2.30(X)		
270pF(271)					2.30(X)					2.30(X)		
300pF(301)					2.30(X)					2.30(X)		
330pF(331)					2.30(X)					2.30(X)		
360pF(361)					2.30(X)					2.30(X)		
390pF(391)					2.30(X)					2.30(X)		
430pF(431)					2.30(X)					2.30(X)		

Continued on the following page. ↗



Continued from the preceding page.

Part Number	ERF1D				ERF22							
L x W	1.40x1.40				2.80x2.80							
TC	COG (5C)	CH (6C)	COG (5C)					CH (6C)				
Rated Volt.	50 (1H)	50 (1H)	500 (2H)	300 (YD)	200 (2D)	100 (2A)	50 (1H)	500 (2H)	300 (YD)	200 (2D)	100 (2A)	50 (1H)
Capacitance (Capacitance part numbering code) and T (mm) Dimension (T Dimension part numbering code)												
470pF(471)					2.30(X)					2.30(X)		
510pF(511)						2.30(X)					2.30(X)	
560pF(561)						2.30(X)					2.30(X)	
620pF(621)						2.30(X)					2.30(X)	
680pF(681)						2.30(X)					2.30(X)	
750pF(751)							2.30(X)					2.30(X)
820pF(821)							2.30(X)					2.30(X)
910pF(911)							2.30(X)					2.30(X)
1000pF(102)							2.30(X)					2.30(X)

The part numbering code is shown in ( ).  
Dimensions are shown in mm and Rated Voltage in Vdc.

## Ribbon Terminal

### Features (ERH Series)

1. The dielectric is composed of low dielectric loss ceramics. This series is perfectly suited to high frequency applications (VHS-microwave band).
2. The series is ultraminiature, yet has a high power capacity. This is the best capacitor available for transmitter and amplifier circuits such as those in broadcasting equipment and mobile base stations.
3. ERH1X/3X Series capacitors withstand high temperatures because ribbon leads are attached with silver paste.
4. ERH1X/3X Series capacitors are easily soldered and especially well suited in applications where only a soldering iron can be used.

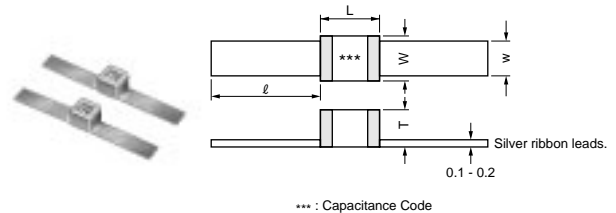

Part Number	Dimensions (mm)				
	L	W	T max.	l	w
ERH1XC	1.6 ±0.4	1.4 ±0.4	1.6	5.0 min.	1.3 ±0.4
ERH3XX	3.2 ±0.4	2.8 ±0.4	3.0	9.0 ±2.0	2.35 ±0.15

### Applications

High frequency and high power circuits

Part Number	ERH1X				ERH3X							
L x W	1.60x1.40				3.20x2.80							
TC	COG (5C)	CH (6C)	COG (5C)					CH (6C)				
Rated Volt.	50 (1H)	50 (1H)	500 (2H)	300 (YD)	200 (2D)	100 (2A)	50 (1H)	500 (2H)	300 (YD)	200 (2D)	100 (2A)	50 (1H)
Capacitance (Capacitance part numbering code) and T (mm) Dimension (T Dimension part numbering code)												
0.50pF(R50)	1.60(C)	1.60(C)	3.00(X)					3.00(X)				
0.6pF(R60)	1.60(C)		3.00(X)									
0.7pF(R70)	1.60(C)		3.00(X)									
0.75pF(R75)		1.60(C)						3.00(X)				
0.8pF(R80)	1.60(C)		3.00(X)									
0.9pF(R90)	1.60(C)		3.00(X)									
1.0pF(1R0)	1.60(C)	1.60(C)	3.00(X)					3.00(X)				
1.1pF(1R1)	1.60(C)		3.00(X)									
1.2pF(1R2)	1.60(C)		3.00(X)									
1.3pF(1R3)	1.60(C)		3.00(X)									
1.4pF(1R4)	1.60(C)		3.00(X)									
1.5pF(1R5)	1.60(C)	1.60(C)	3.00(X)					3.00(X)				

Continued on the following page.

Continued from the preceding page.

Part Number	ERH1X		ERH3X									
L x W	1.60x1.40		3.20x2.80									
TC	COG (5C)	CH (6C)	COG (5C)					CH (6C)				
Rated Volt.	50 (1H)	50 (1H)	500 (2H)	300 (YD)	200 (2D)	100 (2A)	50 (1H)	500 (2H)	300 (YD)	200 (2D)	100 (2A)	50 (1H)
Capacitance (Capacitance part numbering code) and T (mm) Dimension (T Dimension part numbering code)												
1.6pF(1R6)	1.60(C)		3.00(X)									
1.7pF(1R7)	1.60(C)		3.00(X)									
1.8pF(1R8)	1.60(C)		3.00(X)									
1.9pF(1R9)	1.60(C)		3.00(X)									
2.0pF(2R0)	1.60(C)	1.60(C)	3.00(X)					3.00(X)				
2.1pF(2R1)	1.60(C)		3.00(X)									
2.2pF(2R2)	1.60(C)		3.00(X)									
2.4pF(2R4)	1.60(C)		3.00(X)									
2.7pF(2R7)	1.60(C)		3.00(X)									
3.0pF(3R0)	1.60(C)	1.60(C)	3.00(X)					3.00(X)				
3.3pF(3R3)	1.60(C)		3.00(X)									
3.6pF(3R6)	1.60(C)		3.00(X)									
3.9pF(3R9)	1.60(C)		3.00(X)									
4.0pF(4R0)		1.60(C)						3.00(X)				
4.3pF(4R3)	1.60(C)		3.00(X)									
4.7pF(4R7)	1.60(C)		3.00(X)									
5.0pF(5R0)		1.60(C)						3.00(X)				
5.1pF(5R1)	1.60(C)		3.00(X)									
5.6pF(5R6)	1.60(C)		3.00(X)									
6.0pF(6R0)		1.60(C)						3.00(X)				
6.2pF(6R2)	1.60(C)		3.00(X)									
6.8pF(6R8)	1.60(C)		3.00(X)									
7.0pF(7R0)		1.60(C)						3.00(X)				
7.5pF(7R5)	1.60(C)		3.00(X)									
8.0pF(8R0)		1.60(C)						3.00(X)				
8.2pF(8R2)	1.60(C)		3.00(X)									
9.0pF(9R0)		1.60(C)						3.00(X)				
9.1pF(9R1)	1.60(C)		3.00(X)									
10pF(100)	1.60(C)	1.60(C)	3.00(X)					3.00(X)				
11pF(110)	1.60(C)	1.60(C)	3.00(X)					3.00(X)				
12pF(120)	1.60(C)	1.60(C)	3.00(X)					3.00(X)				
13pF(130)	1.60(C)	1.60(C)	3.00(X)					3.00(X)				
15pF(150)	1.60(C)	1.60(C)	3.00(X)					3.00(X)				
16pF(160)	1.60(C)	1.60(C)	3.00(X)					3.00(X)				
18pF(180)	1.60(C)	1.60(C)	3.00(X)					3.00(X)				
20pF(200)	1.60(C)	1.60(C)	3.00(X)					3.00(X)				
22pF(220)	1.60(C)	1.60(C)	3.00(X)					3.00(X)				
24pF(240)	1.60(C)	1.60(C)	3.00(X)					3.00(X)				
27pF(270)	1.60(C)	1.60(C)	3.00(X)					3.00(X)				
30pF(300)	1.60(C)	1.60(C)	3.00(X)					3.00(X)				
33pF(330)	1.60(C)	1.60(C)	3.00(X)					3.00(X)				
36pF(360)	1.60(C)	1.60(C)	3.00(X)					3.00(X)				
39pF(390)	1.60(C)	1.60(C)	3.00(X)					3.00(X)				
43pF(430)	1.60(C)	1.60(C)	3.00(X)					3.00(X)				
47pF(470)	1.60(C)	1.60(C)	3.00(X)					3.00(X)				
51pF(510)	1.60(C)	1.60(C)	3.00(X)					3.00(X)				
56pF(560)	1.60(C)	1.60(C)	3.00(X)					3.00(X)				
62pF(620)	1.60(C)	1.60(C)	3.00(X)					3.00(X)				
68pF(680)	1.60(C)	1.60(C)	3.00(X)					3.00(X)				
75pF(750)	1.60(C)	1.60(C)	3.00(X)					3.00(X)				
82pF(820)	1.60(C)	1.60(C)	3.00(X)					3.00(X)				
91pF(910)	1.60(C)	1.60(C)	3.00(X)					3.00(X)				

Continued on the following page. ↗

Continued from the preceding page.

Part Number	ERH1X		ERH3X									
L x W	1.60x1.40		3.20x2.80									
TC	COG (5C)	CH (6C)	COG (5C)					CH (6C)				
Rated Volt.	50 (1H)	50 (1H)	500 (2H)	300 (YD)	200 (2D)	100 (2A)	50 (1H)	500 (2H)	300 (YD)	200 (2D)	100 (2A)	50 (1H)
Capacitance (Capacitance part numbering code) and T (mm) Dimension (T Dimension part numbering code)												
100pF(101)	1.60(C)	1.60(C)	3.00(X)					3.00(X)				
110pF(111)				3.00(X)					3.00(X)			
120pF(121)				3.00(X)					3.00(X)			
130pF(131)				3.00(X)					3.00(X)			
150pF(151)				3.00(X)					3.00(X)			
160pF(161)				3.00(X)					3.00(X)			
180pF(181)				3.00(X)					3.00(X)			
200pF(201)				3.00(X)					3.00(X)			
220pF(221)					3.00(X)					3.00(X)		
240pF(241)					3.00(X)					3.00(X)		
270pF(271)					3.00(X)					3.00(X)		
300pF(301)					3.00(X)					3.00(X)		
330pF(331)					3.00(X)					3.00(X)		
360pF(361)					3.00(X)					3.00(X)		
390pF(391)					3.00(X)					3.00(X)		
430pF(431)					3.00(X)					3.00(X)		
470pF(471)					3.00(X)					3.00(X)		
510pF(511)						3.00(X)					3.00(X)	
560pF(561)						3.00(X)					3.00(X)	
620pF(621)						3.00(X)					3.00(X)	
680pF(681)						3.00(X)					3.00(X)	
750pF(751)							3.00(X)					3.00(X)
820pF(821)							3.00(X)					3.00(X)
910pF(911)							3.00(X)					3.00(X)
1000pF(102)							3.00(X)					3.00(X)

The part numbering code is shown in ( ).  
Dimensions are shown in mm and Rated Voltage in Vdc.

## Specifications and Test Methods

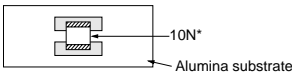
No.	Item	Specifications	Test Method						
1	Operating Temperature Range	-55°C to +125°C							
2	Rated Voltage	See the previous pages.	The rated voltage is defined as the maximum voltage which may be applied continuously to the capacitor. When AC voltage is superimposed on DC voltage, $V^{P-P}$ or $V^{O-P}$ , whichever is larger, should be maintained within the rated voltage range.						
3	Appearance	No defects or abnormalities	Visual inspection						
4	Dimensions	Within the specified dimension	Using calipers						
5	Dielectric Strength	No defects or abnormalities	No failure should be observed when 250% of the rated voltage is applied between the terminations for 1 to 5 seconds, provided the charge/discharge current is less than 50mA.						
6	Insulation Resistance (I.R.)	25°C $C \leq 470\text{pF} : 1,000,000\text{M}\Omega \text{ min.}$ $470\text{pF} < C \leq 1,000\text{pF} : 100,000\text{M}\Omega \text{ min.}$	The insulation resistance should be measured with a DC voltage not exceeding the rated voltage at 25°C and 125°C standard humidity and within 2 minutes of charging.						
		125°C $C \leq 470\text{pF} : 100,000\text{M}\Omega \text{ min.}$ $470\text{pF} < C \leq 1,000\text{pF} : 10,000\text{M}\Omega \text{ min.}$							
7	Capacitance	Within the specified tolerance.	The capacitance/Q should be measured at 25°C at the frequency and voltage shown in the table.						
8	Q	$C \leq 220\text{pF} : Q \geq 10,000$ $220\text{pF} < C \leq 470\text{pF} : Q \geq 5,000$ $470\text{pF} < C \leq 1,000\text{pF} : Q \geq 3,000$ C : Nominal Capacitance (pF)	<table border="1"> <thead> <tr> <th>Item</th> <th></th> </tr> </thead> <tbody> <tr> <td>Frequency</td> <td>1±0.1MHz</td> </tr> <tr> <td>Voltage</td> <td>0.5 to 5Vr.m.s.</td> </tr> </tbody> </table>	Item		Frequency	1±0.1MHz	Voltage	0.5 to 5Vr.m.s.
		Item							
Frequency	1±0.1MHz								
Voltage	0.5 to 5Vr.m.s.								
9	Capacitance Temperature Characteristics	Capacitance Variation Rate Within the specified tolerance (Table A-7)	The temperature coefficient is determined using the capacitance measured in step 3 as a reference. When cycling the temperature sequentially from step 1 through 5, the capacitance should be within the specified tolerance for the temperature coefficient and capacitance change as Table A. The capacitance drift is calculated by dividing the differences between the maximum and minimum measured values in steps 1, 3 and 5 by the capacitance value in step 3. The capacitance change should be measured after 5 min. at each specified temperature stage.						
		Temperature Coefficient Within the specified tolerance (Table A-7)							
		Capacitance Drift Within ±0.2% or ±0.05pF (Whichever is larger)							
10	Terminal Strength	Adhesive Strength of Termination (for chip type) No removal of the terminations or other defects should occur.	Solder the capacitor to the test jig (alumina substrate) shown in Fig. 1 using solder containing 2.5% silver. The soldering should be done either with an iron or in furnace and be conducted with care so the soldering is uniform and free of defects such as heat shock. Then apply a 10N* force in the direction of the arrow.   <p style="text-align: right;">*ERF1D : 5N</p> <p style="text-align: center;">Fig. 1</p>						
		Tensile Strength (for micro-strip type) Capacitor should not be broken or damaged.	The capacitor body is fixed and a load is applied gradually in the axial direction until its value reaches 10N (5N for ERH1X).						
		Bending Strength of lead wire terminal (for micro-strip type) Lead wire should not be cut or broken.	Position the main body of the capacitor so the lead wire terminal is perpendicular, and load 2.5N to the lead wire terminal. Bend the main body by 90 degrees, bend back to original position, bend 90 degrees in the reverse direction, and then bend back to original position.						

Continued on the following page. 

## Specifications and Test Methods

Continued from the preceding page.

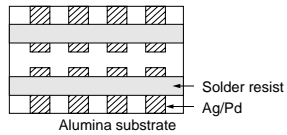
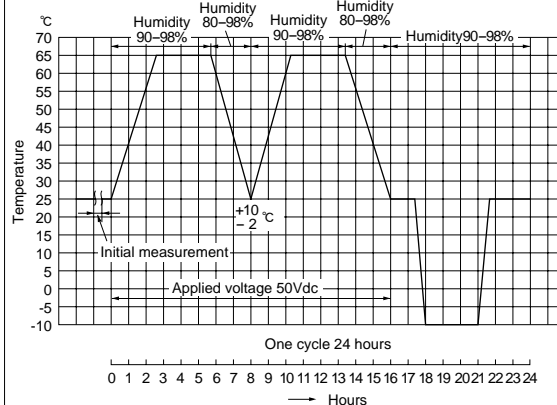
No.	Item	Specifications	Test Method									
11	Appearance	No defects or abnormalities	Solder the capacitor to the test jig (alumina substrate) shown in Fig. 2 using solder containing 2.5% silver. The soldering should be done either with an iron or using the reflow method and should be conducted with care so the soldering is uniform and free of defects such as heat shock. The capacitor should be subjected to a simple harmonic motion having a total amplitude of 1.5mm, the frequency being varied uniformly between the approximate limits of 10 and 55Hz. The frequency range, from 10 to 55Hz and return to 10Hz, should be traversed in approximately 1 minute. This motion should be applied for a period of 2 hours in each of 3 mutually perpendicular directions (total of 6 hours).									
	Capacitance	Within the specified tolerance										
	Vibration Resistance	Satisfies the initial value. $C \leq 220\text{pF} : Q \geq 10,000$ $220\text{pF} < C \leq 470\text{pF} : Q \geq 5,000$ $470\text{pF} < C \leq 1,000\text{pF} : Q \geq 3,000$ C : Nominal Capacitance (pF)	 <p style="text-align: center;">Fig. 2</p>									
12	Solderability of Termination	95% of the terminations are to be soldered evenly and continuously.	Immerse the capacitor in a solution of ethanol (JIS-K-8101) and rosin (JIS-K-5902) (25% rosin in weight proportion). Preheat at 80 to 120°C for 10 to 30 seconds. After preheating immerse in solder containing 2.5% silver for 5±0.5 seconds at 230±5°C. The dipping depth for microstrip type capacitors is up to 1 mm from the root of the terminal.									
13	Resistance to Soldering Heat	The measured and observed characteristics should satisfy the specifications in the following table.	Preheat the capacitor at 80 to 100°C for 2 minutes and then at 150 to 200°C for 5 minutes. Immerse in solder containing 2.5% silver for 3±0.5 seconds at 270±5°C. Set at room temperature for 24±2 hours, then measure. The dipping depth for microstrip type capacitors is up to 2mm from the root of the terminal.									
		<table border="1" style="width: 100%; border-collapse: collapse;"> <thead> <tr> <th style="width: 30%;">Item</th> <th style="width: 70%;">Specifications</th> </tr> </thead> <tbody> <tr> <td>Appearance</td> <td>No marked defect</td> </tr> <tr> <td>Capacitance Change</td> <td>Within ±2.5% or ±0.25pF (Whichever is larger)</td> </tr> <tr> <td>Q</td> <td> <math>C \leq 220\text{pF} : Q \geq 10,000</math>  <math>220\text{pF} &lt; C \leq 470\text{pF} : Q \geq 5,000</math>  <math>470\text{pF} &lt; C \leq 1,000\text{pF} : Q \geq 3,000</math> </td> </tr> <tr> <td>I.R.</td> <td>More than 30% of the initial specification value at 25°C.</td> </tr> <tr> <td>Dielectric Strength</td> <td>No failure</td> </tr> </tbody> </table> <p style="text-align: right;">C : Nominal Capacitance (pF)</p>		Item	Specifications	Appearance	No marked defect	Capacitance Change	Within ±2.5% or ±0.25pF (Whichever is larger)	Q	$C \leq 220\text{pF} : Q \geq 10,000$ $220\text{pF} < C \leq 470\text{pF} : Q \geq 5,000$ $470\text{pF} < C \leq 1,000\text{pF} : Q \geq 3,000$	I.R.
Item	Specifications											
Appearance	No marked defect											
Capacitance Change	Within ±2.5% or ±0.25pF (Whichever is larger)											
Q	$C \leq 220\text{pF} : Q \geq 10,000$ $220\text{pF} < C \leq 470\text{pF} : Q \geq 5,000$ $470\text{pF} < C \leq 1,000\text{pF} : Q \geq 3,000$											
I.R.	More than 30% of the initial specification value at 25°C.											
Dielectric Strength	No failure											
14	Temperature Cycle	The measured and observed characteristics should satisfy the specifications in the following table.	Fix the capacitor to the supporting jig in the same manner and under the same conditions as (11). Perform the five cycles according to the four heat treatments listed in the following table. Then, repeat twice the successive cycles of immersion, each cycle consisting of immersion in a fresh water at 65±5°C for 15 minutes and immersion in a saturated aqueous solution of salt at 0±3°C for 15 minutes. The capacitor is promptly washed with running water, dried with a dry cloth, and allowed to sit at room temperature for 24±2 hours.									
		<table border="1" style="width: 100%; border-collapse: collapse;"> <thead> <tr> <th style="width: 30%;">Item</th> <th style="width: 70%;">Specifications</th> </tr> </thead> <tbody> <tr> <td>Appearance</td> <td>No marked defect</td> </tr> <tr> <td>Capacitance Change</td> <td>Within ±1% or ±0.25pF (Whichever is larger)</td> </tr> <tr> <td>Q</td> <td> <math>C \leq 220\text{pF} : Q \geq 10,000</math>  <math>220\text{pF} &lt; C \leq 470\text{pF} : Q \geq 5,000</math>  <math>470\text{pF} &lt; C \leq 1,000\text{pF} : Q \geq 3,000</math> </td> </tr> <tr> <td>I.R.</td> <td>More than 30% of the initial specification value at 25°C.</td> </tr> <tr> <td>Dielectric Strength</td> <td>No failure</td> </tr> </tbody> </table> <p style="text-align: right;">C : Nominal Capacitance (pF)</p>		Item	Specifications	Appearance	No marked defect	Capacitance Change	Within ±1% or ±0.25pF (Whichever is larger)	Q	$C \leq 220\text{pF} : Q \geq 10,000$ $220\text{pF} < C \leq 470\text{pF} : Q \geq 5,000$ $470\text{pF} < C \leq 1,000\text{pF} : Q \geq 3,000$	I.R.
Item	Specifications											
Appearance	No marked defect											
Capacitance Change	Within ±1% or ±0.25pF (Whichever is larger)											
Q	$C \leq 220\text{pF} : Q \geq 10,000$ $220\text{pF} < C \leq 470\text{pF} : Q \geq 5,000$ $470\text{pF} < C \leq 1,000\text{pF} : Q \geq 3,000$											
I.R.	More than 30% of the initial specification value at 25°C.											
Dielectric Strength	No failure											
15	Humidity	The measured and observed characteristics should satisfy the specifications in the following table.	Apply the 24-hour heat (-10 to +65°C) and humidity (80 to 98%) treatment shown below, 10 consecutive times. Remove, let sit for 24±2 hours at room temperature, and measure.									
		<table border="1" style="width: 100%; border-collapse: collapse;"> <thead> <tr> <th style="width: 30%;">Item</th> <th style="width: 70%;">Specifications</th> </tr> </thead> <tbody> <tr> <td>Appearance</td> <td>No marked defect</td> </tr> <tr> <td>Capacitance Change</td> <td>Within ±5% or ±0.5pF (Whichever is larger)</td> </tr> <tr> <td>Q</td> <td> <math>C \leq 220\text{pF} : Q \geq 10,000</math>  <math>220\text{pF} &lt; C \leq 470\text{pF} : Q \geq 5,000</math>  <math>470\text{pF} &lt; C \leq 1,000\text{pF} : Q \geq 3,000</math> </td> </tr> <tr> <td>I.R.</td> <td>More than 30% of the initial specification value at 25°C.</td> </tr> </tbody> </table> <p style="text-align: right;">C : Nominal Capacitance (pF)</p>		Item	Specifications	Appearance	No marked defect	Capacitance Change	Within ±5% or ±0.5pF (Whichever is larger)	Q	$C \leq 220\text{pF} : Q \geq 10,000$ $220\text{pF} < C \leq 470\text{pF} : Q \geq 5,000$ $470\text{pF} < C \leq 1,000\text{pF} : Q \geq 3,000$	I.R.
Item	Specifications											
Appearance	No marked defect											
Capacitance Change	Within ±5% or ±0.5pF (Whichever is larger)											
Q	$C \leq 220\text{pF} : Q \geq 10,000$ $220\text{pF} < C \leq 470\text{pF} : Q \geq 5,000$ $470\text{pF} < C \leq 1,000\text{pF} : Q \geq 3,000$											
I.R.	More than 30% of the initial specification value at 25°C.											
												

Continued on the following page. ↗

## Specifications and Test Methods

Continued from the preceding page.

No.	Item	Specifications	Test Method										
16	High Temperature Load	<p>The measured and observed characteristics should satisfy the specifications in the following table.</p> <table border="1"> <thead> <tr> <th>Item</th> <th>Specifications</th> </tr> </thead> <tbody> <tr> <td>Appearance</td> <td>No marked defect</td> </tr> <tr> <td>Capacitance Change</td> <td>Within <math>\pm 2.5\%</math> or <math>\pm 0.25\text{pF}</math> (Whichever is larger)</td> </tr> <tr> <td>Q</td> <td><math>C \leq 220\text{pF} : Q \geq 10,000</math> <math>220\text{pF} &lt; C \leq 470\text{pF} : Q \geq 5,000</math> <math>470\text{pF} &lt; C \leq 1,000\text{pF} : Q \geq 3,000</math></td> </tr> <tr> <td>I.R.</td> <td>More than 30% of the initial specification value at 25°C.</td> </tr> </tbody> </table> <p style="text-align: center;">C : Nominal Capacitance (pF)</p>	Item	Specifications	Appearance	No marked defect	Capacitance Change	Within $\pm 2.5\%$ or $\pm 0.25\text{pF}$ (Whichever is larger)	Q	$C \leq 220\text{pF} : Q \geq 10,000$ $220\text{pF} < C \leq 470\text{pF} : Q \geq 5,000$ $470\text{pF} < C \leq 1,000\text{pF} : Q \geq 3,000$	I.R.	More than 30% of the initial specification value at 25°C.	<p>Apply 150% of the rated voltage for 2,000±12 hours at 125±3°C. Remove and let sit for 24±2 hours at room temperature, then measure.</p> <p>The charge/discharge current is less than 50mA.</p>
Item	Specifications												
Appearance	No marked defect												
Capacitance Change	Within $\pm 2.5\%$ or $\pm 0.25\text{pF}$ (Whichever is larger)												
Q	$C \leq 220\text{pF} : Q \geq 10,000$ $220\text{pF} < C \leq 470\text{pF} : Q \geq 5,000$ $470\text{pF} < C \leq 1,000\text{pF} : Q \geq 3,000$												
I.R.	More than 30% of the initial specification value at 25°C.												

Table A

Char. Code	Temp. Coeff. (ppm/°C) Note 1	Capacitance Change from 25°C Value (%)					
		-55°C		-30°C		-10°C	
		Max.	Min.	Max.	Min.	Max.	Min.
5C	0±30	0.58	-0.24	0.40	-0.17	0.25	-0.11

Note 1 : Nominal values denote the temperature coefficient within a range of 25 to 125°C.

# Chip Monolithic Ceramic Capacitors



## High Frequency Type

### SMD Type

#### ■ Features (ERA Series)

1. Negligible inductance is achieved by its monolithic structure so the series can be used at frequencies above 1GHz.
2. Nickel barriered terminations of ERA series improve solderability and decrease solder leaching.
3. ERA11A/21A series are designed for both flow and reflow soldering and ERA32 series are designed for reflow soldering.

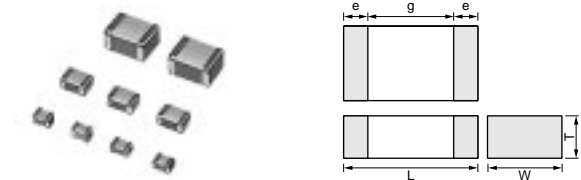

Part Number	Dimensions (mm)				
	L	W	T max.	e	g min.
ERA11A	1.25 <sup>+0.5</sup> <sub>-0.3</sub>	1.0 <sup>+0.5</sup> <sub>-0.3</sub>	1.0±0.2	0.15 min.	0.3
ERA21A ERA21B	2.0 <sup>+0.5</sup> <sub>-0.3</sub>	1.25 <sup>+0.5</sup> <sub>-0.3</sub>	1.0±0.2 1.25±0.2	0.2 min.	0.5
ERA32X	3.2 <sup>+0.6</sup> <sub>-0.4</sub>	2.5 <sup>+0.5</sup> <sub>-0.3</sub>	1.7±0.2	0.3 min.	0.5

#### ■ Applications

High frequency and high power circuits

Part Number	ERA11								ERA21								ERA32							
	1.25x1.00								2.00x1.25								3.20x2.50							
TC	COG (5C)		CH (6C)		CJ (7C)	CK (8C)	COG (5C)		CH (6C)		CJ (7C)	CK (8C)	COG (5C)		CH (6C)		CJ (7C)	CK (8C)						
Rated Volt.	200 (2D)	100 (2A)	50 (1H)	200 (2D)	100 (2A)	50 (1H)	200 (2D)	200 (2D)	200 (2D)	100 (2A)	50 (1H)	200 (2D)	200 (2D)	200 (2D)	100 (2A)	50 (1H)	200 (2D)	200 (2D)	200 (2D)					
Capacitance (Capacitance part numbering code) and T (mm) Dimension (T Dimension part numbering code)																								
0.50pF (R50)	1.00 (A)						1.20 (A)	1.00 (A)					1.00 (A)	1.70 (X)					1.70 (X)					
0.6pF (R60)	1.00 (A)							1.00 (A)						1.70 (X)										
0.7pF (R70)	1.00 (A)							1.00 (A)						1.70 (X)										
0.75pF (R75)							1.20 (A)						1.00 (A)						1.70 (X)					
0.8pF (R80)	1.00 (A)							1.00 (A)						1.70 (X)										
0.9pF (R90)	1.00 (A)							1.00 (A)						1.70 (X)										
1.0pF (1R0)	1.00 (A)						1.20 (A)	1.00 (A)					1.00 (A)	1.70 (X)					1.70 (X)					
1.1pF (1R1)	1.00 (A)							1.00 (A)						1.70 (X)										
1.2pF (1R2)	1.00 (A)							1.00 (A)						1.70 (X)										
1.3pF (1R3)	1.00 (A)							1.00 (A)						1.70 (X)										
1.4pF (1R4)	1.00 (A)							1.00 (A)						1.70 (X)										
1.5pF (1R5)	1.00 (A)						1.20 (A)	1.00 (A)					1.00 (A)	1.70 (X)					1.70 (X)					
1.6pF (1R6)	1.00 (A)							1.00 (A)						1.70 (X)										
1.7pF (1R7)	1.00 (A)							1.00 (A)						1.70 (X)										
1.8pF (1R8)	1.00 (A)							1.00 (A)						1.70 (X)										

Continued on the following page.

☐ Continued from the preceding page.

Part Number	ERA11								ERA21								ERA32							
L x W	1.25x1.00								2.00x1.25								3.20x2.50							
TC	COG (5C)			CH (6C)			CJ (7C)	CK (8C)	COG (5C)			CH (6C)			CJ (7C)	CK (8C)	COG (5C)			CH (6C)			CJ (7C)	CK (8C)
Rated Volt.	200 (2D)	100 (2A)	50 (1H)	200 (2D)	100 (2A)	50 (1H)	200 (2D)	200 (2D)	200 (2D)	100 (2A)	50 (1H)	200 (2D)	100 (2A)	50 (1H)	200 (2D)	200 (2D)	200 (2D)	100 (2A)	50 (1H)	200 (2D)	100 (2A)	50 (1H)	200 (2D)	200 (2D)
Capacitance (Capacitance part numbering code) and T (mm) Dimension (T Dimension part numbering code)																								
1.9pF (1R9)	1.00 (A)								1.00 (A)								1.70 (X)							
2.0pF (2R0)	1.00 (A)							1.20 (A)	1.00 (A)							1.00 (A)	1.70 (X)							1.70 (X)
2.1pF (2R1)	1.00 (A)								1.00 (A)								1.70 (X)							
2.2pF (2R2)	1.00 (A)								1.00 (A)								1.70 (X)							
2.4pF (2R4)	1.00 (A)								1.00 (A)								1.70 (X)							
2.7pF (2R7)	1.00 (A)								1.00 (A)								1.70 (X)							
3.0pF (3R0)	1.00 (A)						1.20 (A)	1.00 (A)							1.00 (A)	1.70 (X)							1.70 (X)	
3.3pF (3R3)	1.00 (A)								1.00 (A)								1.70 (X)							
3.6pF (3R6)	1.00 (A)								1.00 (A)								1.70 (X)							
3.9pF (3R9)	1.00 (A)								1.00 (A)								1.70 (X)							
4.0pF (4R0)				1.00 (A)									1.00 (A)							1.70 (X)				
4.3pF (4R3)	1.00 (A)								1.00 (A)								1.70 (X)							
4.7pF (4R7)	1.00 (A)								1.00 (A)								1.70 (X)							
5.0pF (5R0)				1.00 (A)									1.00 (A)							1.70 (X)				
5.1pF (5R1)	1.00 (A)								1.00 (A)								1.70 (X)							
5.6pF (5R6)	1.00 (A)								1.00 (A)								1.70 (X)							
6.0pF (6R0)				1.00 (A)									1.00 (A)							1.70 (X)				
6.2pF (6R2)	1.00 (A)								1.00 (A)								1.70 (X)							
6.8pF (6R8)	1.00 (A)								1.00 (A)								1.70 (X)							
7.0pF (7R0)				1.20 (A)									1.00 (A)							1.70 (X)				
7.5pF (7R5)	1.00 (A)								1.00 (A)								1.70 (X)							
8.0pF (8R0)				1.20 (A)									1.00 (A)							1.70 (X)				
8.2pF (8R2)	1.00 (A)								1.00 (A)								1.70 (X)							
9.0pF (9R0)				1.20 (A)	1.00 (A)								1.25 (B)							1.70 (X)				
9.1pF (9R1)	1.00 (A)								1.25 (B)								1.70 (X)							
10pF (100)	1.00 (A)			1.00 (A)	1.00 (A)				1.25 (B)				1.25 (B)				1.70 (X)						1.70 (X)	

Continued on the following page. ☐



Continued from the preceding page.

Part Number	ERA11								ERA21								ERA32								
L x W	1.25x1.00								2.00x1.25								3.20x2.50								
TC	COG (5C)			CH (6C)			CJ (7C)	CK (8C)	COG (5C)			CH (6C)			CJ (7C)	CK (8C)	COG (5C)			CH (6C)			CJ (7C)	CK (8C)	
Rated Volt.	200 (2D)	100 (2A)	50 (1H)	200 (2D)	100 (2A)	50 (1H)	200 (2D)	200 (2D)	200 (2D)	100 (2A)	50 (1H)	200 (2D)	100 (2A)	50 (1H)	200 (2D)	200 (2D)	200 (2D)	100 (2A)	50 (1H)	200 (2D)	100 (2A)	50 (1H)	200 (2D)	200 (2D)	
Capacitance (Capacitance part numbering code) and T (mm) Dimension (T Dimension part numbering code)																									
11pF (110)	1.00 (A)			1.00 (A)	1.00 (A)					1.25 (B)			1.25 (B)							1.70 (X)			1.70 (X)		
12pF (120)	1.00 (A)			1.00 (A)	1.00 (A)					1.25 (B)			1.25 (B)							1.70 (X)			1.70 (X)		
13pF (130)	1.00 (A)			1.00 (A)	1.00 (A)					1.25 (B)			1.25 (B)							1.70 (X)			1.70 (X)		
15pF (150)		1.00 (A)			1.00 (A)					1.25 (B)			1.25 (B)							1.70 (X)			1.70 (X)		
16pF (160)		1.00 (A)			1.00 (A)	1.00 (A)				1.25 (B)			1.25 (B)							1.00 (X)			1.70 (X)		
18pF (180)		1.00 (A)			1.00 (A)	1.00 (A)				1.25 (B)			1.25 (B)							1.70 (X)			1.70 (X)		
20pF (200)		1.00 (A)			1.00 (A)	1.00 (A)				1.25 (B)			1.25 (B)							1.70 (X)			1.70 (X)		
22pF (220)		1.00 (A)			1.00 (A)	1.00 (A)				1.25 (B)			1.25 (B)							1.70 (X)			1.70 (X)		
24pF (240)			1.00 (A)			1.00 (A)				1.25 (B)			1.25 (B)							1.70 (X)			1.70 (X)		
27pF (270)			1.00 (A)			1.00 (A)				1.25 (B)			1.25 (B)							1.70 (X)			1.70 (X)		
30pF (300)			1.00 (A)			1.00 (A)				1.25 (B)			1.25 (B)							1.70 (X)			1.70 (X)		
33pF (330)			1.00 (A)			1.00 (A)				1.25 (B)			1.25 (B)							1.70 (X)			1.70 (X)		
36pF (360)			1.00 (A)			1.00 (A)				1.25 (B)			1.25 (B)							1.70 (X)			1.70 (X)		
39pF (390)			1.00 (A)			1.00 (A)				1.25 (B)			1.25 (B)							1.70 (X)			1.70 (X)		
43pF (430)			1.00 (A)			1.00 (A)				1.25 (B)			1.25 (B)							1.70 (X)			1.70 (X)		
47pF (470)			1.00 (A)			1.00 (A)				1.25 (B)			1.25 (B)							1.70 (X)			1.70 (X)		
51pF (510)			1.00 (A)			1.00 (A)				1.25 (B)			1.25 (B)							1.70 (X)			1.70 (X)		
56pF (560)										1.25 (B)			1.25 (B)							1.70 (X)			1.70 (X)		
62pF (620)										1.25 (B)			1.25 (B)							1.70 (X)			1.70 (X)		
68pF (680)										1.25 (B)			1.25 (B)							1.70 (X)			1.70 (X)		
75pF (750)										1.25 (B)			1.25 (B)							1.70 (X)			1.70 (X)		
82pF (820)										1.25 (B)			1.25 (B)							1.70 (X)			1.70 (X)		
91pF (910)										1.25 (B)			1.25 (B)							1.70 (X)			1.70 (X)		
100pF (101)											1.00 (A)				1.00 (A)					1.70 (X)			1.70 (X)		
110pF (111)											1.25 (B)				1.25 (B)					1.70 (X)			1.70 (X)		
120pF (121)											1.25 (B)				1.25 (B)					1.70 (X)			1.70 (X)		

Continued on the following page. ↗

Continued from the preceding page.

Part Number	ERA11								ERA21								ERA32									
L x W	1.25x1.00								2.00x1.25								3.20x2.50									
TC	COG (5C)			CH (6C)			CJ (7C)	CK (8C)	COG (5C)			CH (6C)			CJ (7C)	CK (8C)	COG (5C)			CH (6C)			CJ (7C)	CK (8C)		
Rated Volt.	200 (2D)	100 (2A)	50 (1H)	200 (2D)	100 (2A)	50 (1H)	200 (2D)	200 (2D)	200 (2D)	100 (2A)	50 (1H)	200 (2D)	100 (2A)	50 (1H)	200 (2D)	200 (2D)	200 (2D)	100 (2A)	50 (1H)	200 (2D)	100 (2A)	50 (1H)	200 (2D)	200 (2D)		
Capacitance (Capacitance part numbering code) and T (mm) Dimension (T Dimension part numbering code)																										
130pF (131)											1.25 (B)															
150pF (151)											1.25 (B)															
160pF (161)											1.25 (B)															
180pF (181)																							1.70 (X)			
200pF (201)																							1.70 (X)			
220pF (221)																							1.70 (X)			
240pF (241)																							1.70 (X)			
270pF (271)																							1.70 (X)			
300pF (301)																							1.70 (X)			
330pF (331)																							1.70 (X)			
360pF (361)																							1.70 (X)			
390pF (391)																							1.70 (X)			
430pF (431)																							1.70 (X)			
470pF (471)																							1.70 (X)			
510pF (511)																							1.70 (X)			
560pF (561)																								1.70 (X)		
620pF (621)																								1.70 (X)		
680pF (681)																								1.70 (X)		
750pF (751)																								1.70 (X)		
820pF (821)																								1.70 (X)		
910pF (911)																								1.70 (X)		
1000pF (102)																								1.70 (X)		

The part numbering code is shown in ( ).  
Dimensions are shown in mm and Rated Voltage in Vdc.

## Ribbon Terminal

### ■ Features (ERD Series)

1. Negligible inductance is achieved by its monolithic structure so the series can be used at frequencies above 1GHz.
2. ERD Series capacitors withstand at high temperatures because ribbon leads are attached with silver paste.
3. ERD Series capacitors are easily soldered and are especially well suited in applications where only a soldering iron can be used.

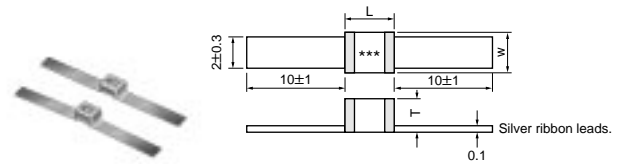

\*\*\* : Capacitance Code

Part Number	Dimensions (mm)		
	L max.	W max.	T max.
<b>ERD32D</b>	4.0	3.0	2.3

### ■ Application

High frequency and high power circuits

Part Number	ERD32							
L x W	4.00x3.00							
TC	COG (5C)			CH (6C)			CJ (7C)	CK (8C)
Rated Volt.	200 (2D)	100 (2A)	50 (1H)	200 (2D)	100 (2A)	50 (1H)	200 (2D)	200 (2D)
Capacitance (Capacitance part numbering code) and T (mm) Dimension (T Dimension part numbering code)								
0.50pF( <b>R50</b> )	2.30( <b>D</b> )							2.30( <b>D</b> )
0.6pF( <b>R60</b> )	2.30( <b>D</b> )							
0.7pF( <b>R70</b> )	2.30( <b>D</b> )							
0.75pF( <b>R75</b> )								2.30( <b>D</b> )
0.8pF( <b>R80</b> )	2.30( <b>D</b> )							
0.9pF( <b>R90</b> )	2.30( <b>D</b> )							
1.0pF( <b>1R0</b> )	2.30( <b>D</b> )							2.30( <b>D</b> )
1.1pF( <b>1R1</b> )	2.30( <b>D</b> )							
1.2pF( <b>1R2</b> )	2.30( <b>D</b> )							
1.3pF( <b>1R3</b> )	2.30( <b>D</b> )							
1.4pF( <b>1R4</b> )	2.30( <b>D</b> )							
1.5pF( <b>1R5</b> )	2.30( <b>D</b> )							2.30( <b>D</b> )
1.6pF( <b>1R6</b> )	2.30( <b>D</b> )							
1.7pF( <b>1R7</b> )	2.30( <b>D</b> )							
1.8pF( <b>1R8</b> )	2.30( <b>D</b> )							
1.9pF( <b>1R9</b> )	2.30( <b>D</b> )							
2.0pF( <b>2R0</b> )	2.30( <b>D</b> )							2.30( <b>D</b> )
2.1pF( <b>2R1</b> )	2.30( <b>D</b> )							
2.2pF( <b>2R2</b> )	2.30( <b>D</b> )							
2.4pF( <b>2R4</b> )	2.30( <b>D</b> )							
2.7pF( <b>2R7</b> )	2.30( <b>D</b> )							
3.0pF( <b>3R0</b> )	2.30( <b>D</b> )						2.30( <b>D</b> )	
3.3pF( <b>3R3</b> )	2.30( <b>D</b> )							
3.6pF( <b>3R6</b> )	2.30( <b>D</b> )							
3.9pF( <b>3R9</b> )	2.30( <b>D</b> )							
4.0pF( <b>4R0</b> )				2.30( <b>D</b> )				
4.3pF( <b>4R3</b> )	2.30( <b>D</b> )							
4.7pF( <b>4R7</b> )	2.30( <b>D</b> )							
5.0pF( <b>5R0</b> )				2.30( <b>D</b> )				
5.1pF( <b>5R1</b> )	2.30( <b>D</b> )							
5.6pF( <b>5R6</b> )	2.30( <b>D</b> )							
6.0pF( <b>6R0</b> )				2.30( <b>D</b> )				
6.2pF( <b>6R2</b> )	2.30( <b>D</b> )							
6.8pF( <b>6R8</b> )	2.30( <b>D</b> )							
7.0pF( <b>7R0</b> )				2.30( <b>D</b> )				

Continued on the following page.

☐ Continued from the preceding page.

Part Number	ERD32							
L x W	4.00x3.00							
TC	C0G (5C)			CH (6C)			CJ (7C)	CK (8C)
Rated Volt.	200 (2D)	100 (2A)	50 (1H)	200 (2D)	100 (2A)	50 (1H)	200 (2D)	200 (2D)
Capacitance (Capacitance part numbering code) and T (mm) Dimension (T Dimension part numbering code)								
7.5pF(7R5)	2.30(D)							
8.0pF(8R0)				2.30(D)				
8.2pF(8R2)	2.30(D)							
9.0pF(9R0)				2.30(D)				
9.1pF(9R1)	2.30(D)							
10pF(100)	2.30(D)			2.30(D)				
11pF(110)	2.30(D)			2.30(D)				
12pF(120)	2.30(D)			2.30(D)				
13pF(130)	2.30(D)			2.30(D)				
15pF(150)	2.30(D)			2.30(D)				
16pF(160)	2.30(D)			2.30(D)				
18pF(180)	2.30(D)			2.30(D)				
20pF(200)	2.30(D)			2.30(D)				
22pF(220)	2.30(D)			2.30(D)				
24pF(240)	2.30(D)			2.30(D)				
27pF(270)	2.30(D)			2.30(D)				
30pF(300)	2.30(D)			2.30(D)				
33pF(330)	2.30(D)			2.30(D)				
36pF(360)	2.30(D)			2.30(D)				
39pF(390)	2.30(D)			2.30(D)				
43pF(430)	2.30(D)			2.30(D)				
47pF(470)	2.30(D)			2.30(D)				
51pF(510)	2.30(D)			2.30(D)				
56pF(560)	2.30(D)			2.30(D)				
62pF(620)	2.30(D)			2.30(D)				
68pF(680)	2.30(D)			2.30(D)				
75pF(750)	2.30(D)			2.30(D)				
82pF(820)	2.30(D)			2.30(D)				
91pF(910)	2.30(D)			2.30(D)				
100pF(101)	2.30(D)			2.30(D)				
110pF(111)	2.30(D)			2.30(D)				
120pF(121)	2.30(D)			2.30(D)				
130pF(131)	2.30(D)			2.30(D)				
150pF(151)	2.30(D)			2.30(D)				
160pF(161)	2.30(D)			2.30(D)				
180pF(181)		2.30(D)			2.30(D)			
200pF(201)		2.30(D)			2.30(D)			
220pF(221)		2.30(D)			2.30(D)			
240pF(241)		2.30(D)			2.30(D)			
270pF(271)		2.30(D)			2.30(D)			
300pF(301)		2.30(D)			2.30(D)			
330pF(331)		2.30(D)			2.30(D)			
360pF(361)		2.30(D)			2.30(D)			
390pF(391)		2.30(D)			2.30(D)			
430pF(431)		2.30(D)			2.30(D)			
470pF(471)		2.30(D)			2.30(D)			
510pF(511)		2.30(D)			2.30(D)			
560pF(561)			2.30(D)			2.30(D)		
620pF(621)			2.30(D)			2.30(D)		
680pF(681)			2.30(D)			2.30(D)		
750pF(751)			2.30(D)			2.30(D)		
820pF(821)			2.30(D)			2.30(D)		

Continued on the following page. ☐

☐ Continued from the preceding page.

Part Number	ERD32							
L x W	4.00x3.00							
TC	COG (5C)			CH (6C)			CJ (7C)	CK (8C)
Rated Volt.	200 (2D)	100 (2A)	50 (1H)	200 (2D)	100 (2A)	50 (1H)	200 (2D)	200 (2D)
Capacitance (Capacitance part numbering code) and T (mm) Dimension (T Dimension part numbering code)								
910pF(911)			2.30(D)			2.30(D)		
1000pF(102)			2.30(D)			2.30(D)		

The part numbering code is shown in ( ).  
 Dimensions are shown in mm and Rated Voltage in Vdc.

## Specifications and Test Methods

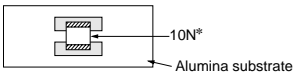
No.	Item	Specifications	Test Method									
1	Operating Temperature Range	-55°C to +125°C										
2	Rated Voltage	See the previous pages.	The rated voltage is defined as the maximum voltage which may be applied continuously to the capacitor. When AC voltage is superimposed on DC voltage, $V^{P-P}$ or $V^{O-P}$ , whichever is larger, should be maintained within the rated voltage range.									
3	Appearance	No defects or abnormalities	Visual inspection									
4	Dimensions	Within the specified dimension	Using calipers									
5	Dielectric Strength	No defects or abnormalities	No failure should be observed when 300% of the rated voltage is applied between the terminations for 1 to 5 seconds, provided the charge/discharge current is less than 50mA.									
6	Insulation Resistance (I.R.)	10,000MΩ min.	The insulation resistance should be measured with a DC voltage not exceeding the rated voltage at 25°C and standard humidity and within 2 minutes of charging.									
7	Capacitance	Within the specified tolerance	The capacitance/Q should be measured at 25°C at the frequency and voltage shown in the table.									
8	Q	$C \leq 220\text{pF} : Q \geq 10,000$ $220\text{pF} < C \leq 470\text{pF} : Q \geq 5,000$ $470\text{pF} < C \leq 1,000\text{pF} : Q \geq 3,000$ C : Nominal Capacitance (pF)	<table border="1" style="width: 100%; border-collapse: collapse;"> <thead> <tr style="background-color: #f2f2f2;"> <th style="width: 30%;">Item</th> <th style="width: 30%;">Char.</th> <th style="width: 40%;">C0G (1,000pF and below)</th> </tr> </thead> <tbody> <tr> <td>Frequency</td> <td></td> <td>1±0.1MHz</td> </tr> <tr> <td>Voltage</td> <td></td> <td>0.5 to 5Vr.m.s.</td> </tr> </tbody> </table>	Item	Char.	C0G (1,000pF and below)	Frequency		1±0.1MHz	Voltage		0.5 to 5Vr.m.s.
Item	Char.	C0G (1,000pF and below)										
Frequency		1±0.1MHz										
Voltage		0.5 to 5Vr.m.s.										
9	Capacitance Temperature Characteristics	Capacitance Variation Rate	Within the specified tolerance (Table A-6)									
		Temperature Coefficient	Within the specified tolerance (Table A-6)									
		Capacitance Drift	Within ±0.2% or ±0.05pF (Whichever is larger)									
10	Terminal Strength	Adhesive Strength of Termination (for chip type)	No removal of the terminations or other defects should occur.   <p style="text-align: right;">*5N (ERA11)</p>									
		Tensile Strength (for micro-strip type)	Capacitor should not be broken or damaged.									
		Bending Strength of lead wire terminal (for micro-strip type)	Lead wire should not be cut or broken.									

Continued on the following page.

13

## Specifications and Test Methods

Continued from the preceding page.

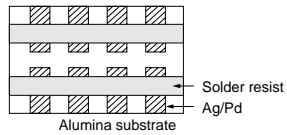
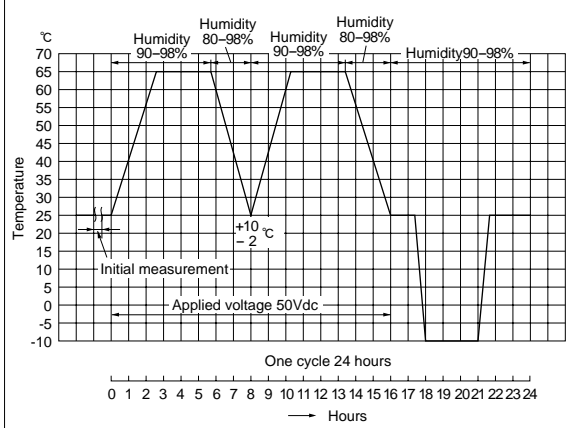
No.	Item	Specifications	Test Method																									
11	Appearance	No defects or abnormalities	Solder the capacitor to the test jig (alumina substrate) shown in Fig. 2 using solder containing 2.5% silver. The soldering should be done either with an iron or using the reflow method and should be conducted with care so the soldering is uniform and free of defects such as heat shock. The capacitor should be subjected to a simple harmonic motion having a total amplitude of 1.5mm, the frequency being varied uniformly between the approximate limits of 10 and 55Hz. The frequency range, from 10 to 55Hz and return to 10Hz, should be traversed in approximately 1 minute. This motion should be applied for a period of 2 hours in each of 3 mutually perpendicular directions (total of 6 hours).																									
	Capacitance	Within the specified tolerance																										
	Vibration Resistance	<p>Satisfies the initial value.</p> <p><math>C \leq 220\text{pF} : Q \geq 10,000</math></p> <p><math>220\text{pF} &lt; C \leq 470\text{pF} : Q \geq 5,000</math></p> <p><math>470\text{pF} &lt; C \leq 1,000\text{pF} : Q \geq 3,000</math></p> <p>C : Nominal Capacitance (pF)</p>	 <p>Fig. 2</p>																									
12	Solderability of Termination	75% of the terminations are to be soldered evenly and continuously.	Immerse the capacitor in a solution of ethanol (JIS-K-8101) and rosin (JIS-K-5902) (25% rosin in weight proportion). Preheat at 80 to 120°C for 10 to 30 seconds. After preheating immerse in solder containing 2.5% silver for 5±0.5 seconds at 230±5°C. The dipping depth for microstrip type capacitors is up to 1 mm from the root of the terminal.																									
13	Resistance to Soldering Heat	The measured and observed characteristics should satisfy the specifications in the following table.	Preheat according to the conditions listed in the table below. Immerse in solder containing 2.5% silver for 3±0.5 seconds at 270±5°C. Set at room temperature for 24±2 hours, then measure. The dipping depth for microstrip type capacitors is up to 2mm from the root of the terminal.																									
		<table border="1" style="width: 100%; border-collapse: collapse;"> <thead> <tr> <th>Item</th> <th>Specifications</th> </tr> </thead> <tbody> <tr> <td>Appearance</td> <td>No marked defect</td> </tr> <tr> <td>Capacitance Change</td> <td>Within ±2.5% or ±0.25pF (Whichever is larger)</td> </tr> <tr> <td>Q</td> <td><math>C \leq 220\text{pF} : Q \geq 10,000</math> <math>220\text{pF} &lt; C \leq 470\text{pF} : Q \geq 5,000</math> <math>470\text{pF} &lt; C \leq 1,000\text{pF} : Q \geq 3,000</math></td> </tr> <tr> <td>Dielectric Strength</td> <td>No failure</td> </tr> </tbody> </table> <p style="text-align: center;">C : Nominal Capacitance (pF)</p>		Item	Specifications	Appearance	No marked defect	Capacitance Change	Within ±2.5% or ±0.25pF (Whichever is larger)	Q	$C \leq 220\text{pF} : Q \geq 10,000$ $220\text{pF} < C \leq 470\text{pF} : Q \geq 5,000$ $470\text{pF} < C \leq 1,000\text{pF} : Q \geq 3,000$	Dielectric Strength	No failure	<table border="1" style="width: 100%; border-collapse: collapse;"> <thead> <tr> <th>Chip Size</th> <th>Preheat Condition</th> </tr> </thead> <tbody> <tr> <td>2.0×1.25mm max.</td> <td>1minute at 120 to 150°C</td> </tr> <tr> <td>3.2×2.5mm</td> <td>Each 1 minute at 100 to 120°C and then 170 to 200°C</td> </tr> </tbody> </table>	Chip Size	Preheat Condition	2.0×1.25mm max.	1minute at 120 to 150°C	3.2×2.5mm	Each 1 minute at 100 to 120°C and then 170 to 200°C								
Item	Specifications																											
Appearance	No marked defect																											
Capacitance Change	Within ±2.5% or ±0.25pF (Whichever is larger)																											
Q	$C \leq 220\text{pF} : Q \geq 10,000$ $220\text{pF} < C \leq 470\text{pF} : Q \geq 5,000$ $470\text{pF} < C \leq 1,000\text{pF} : Q \geq 3,000$																											
Dielectric Strength	No failure																											
Chip Size	Preheat Condition																											
2.0×1.25mm max.	1minute at 120 to 150°C																											
3.2×2.5mm	Each 1 minute at 100 to 120°C and then 170 to 200°C																											
14	Temperature Cycle	The measured and observed characteristics should satisfy the specifications in the following table.	Fix the capacitor to the supporting jig in the same manner and under the same conditions as (11). Perform the five cycles according to the four heat treatments listed in the following table. Let sit for 24±2 hours at room temperature, then measure.																									
		<table border="1" style="width: 100%; border-collapse: collapse;"> <thead> <tr> <th>Item</th> <th>Specifications</th> </tr> </thead> <tbody> <tr> <td>Appearance</td> <td>No marked defect</td> </tr> <tr> <td>Capacitance Change</td> <td>Within ±5% or ±0.5pF (Whichever is larger)</td> </tr> <tr> <td>Q</td> <td><math>C \geq 30\text{pF} : Q \geq 350</math> <math>10\text{pF} \leq C &lt; 30\text{pF} : Q \geq 275 + \frac{5}{2} C</math> <math>C &lt; 10\text{pF} : Q \geq 200 + 10C</math></td> </tr> <tr> <td>I.R.</td> <td>1,000MΩ min.</td> </tr> <tr> <td>Dielectric Strength</td> <td>No failure</td> </tr> </tbody> </table> <p style="text-align: center;">C : Nominal Capacitance (pF)</p>		Item	Specifications	Appearance	No marked defect	Capacitance Change	Within ±5% or ±0.5pF (Whichever is larger)	Q	$C \geq 30\text{pF} : Q \geq 350$ $10\text{pF} \leq C < 30\text{pF} : Q \geq 275 + \frac{5}{2} C$ $C < 10\text{pF} : Q \geq 200 + 10C$	I.R.	1,000MΩ min.	Dielectric Strength	No failure	<table border="1" style="width: 100%; border-collapse: collapse;"> <thead> <tr> <th>Step</th> <th>1</th> <th>2</th> <th>3</th> <th>4</th> </tr> </thead> <tbody> <tr> <td>Temp.(°C)</td> <td>-55 ± 0</td> <td>RoomTemp.</td> <td>125 ± 3</td> <td>RoomTemp.</td> </tr> <tr> <td>Time(min.)</td> <td>30±3</td> <td>2 to 3</td> <td>30±3</td> <td>2 to 3</td> </tr> </tbody> </table>	Step	1	2	3	4	Temp.(°C)	-55 ± 0	RoomTemp.	125 ± 3	RoomTemp.	Time(min.)	30±3
Item	Specifications																											
Appearance	No marked defect																											
Capacitance Change	Within ±5% or ±0.5pF (Whichever is larger)																											
Q	$C \geq 30\text{pF} : Q \geq 350$ $10\text{pF} \leq C < 30\text{pF} : Q \geq 275 + \frac{5}{2} C$ $C < 10\text{pF} : Q \geq 200 + 10C$																											
I.R.	1,000MΩ min.																											
Dielectric Strength	No failure																											
Step	1	2	3	4																								
Temp.(°C)	-55 ± 0	RoomTemp.	125 ± 3	RoomTemp.																								
Time(min.)	30±3	2 to 3	30±3	2 to 3																								
15	Humidity	The measured and observed characteristics should satisfy the specifications in the following table.	Apply the 24-hour heat (-10 to +65°C) and humidity (80 to 98%) treatment shown below, 10 consecutive times. Remove, let sit for 24±2 hours at room temperature, and measure.																									
		<table border="1" style="width: 100%; border-collapse: collapse;"> <thead> <tr> <th>Item</th> <th>Specifications</th> </tr> </thead> <tbody> <tr> <td>Appearance</td> <td>No marked defect</td> </tr> <tr> <td>Capacitance Change</td> <td>Within ±5% or ±0.5pF (Whichever is larger)</td> </tr> <tr> <td>Q</td> <td><math>C \geq 30\text{pF} : Q \geq 350</math> <math>10\text{pF} \leq C &lt; 30\text{pF} : Q \geq 275 + \frac{5}{2} C</math> <math>C &lt; 10\text{pF} : Q \geq 200 + 10C</math></td> </tr> <tr> <td>I.R.</td> <td>1,000MΩ min.</td> </tr> </tbody> </table> <p style="text-align: center;">C : Nominal Capacitance (pF)</p>		Item	Specifications	Appearance	No marked defect	Capacitance Change	Within ±5% or ±0.5pF (Whichever is larger)	Q	$C \geq 30\text{pF} : Q \geq 350$ $10\text{pF} \leq C < 30\text{pF} : Q \geq 275 + \frac{5}{2} C$ $C < 10\text{pF} : Q \geq 200 + 10C$	I.R.	1,000MΩ min.															
Item	Specifications																											
Appearance	No marked defect																											
Capacitance Change	Within ±5% or ±0.5pF (Whichever is larger)																											
Q	$C \geq 30\text{pF} : Q \geq 350$ $10\text{pF} \leq C < 30\text{pF} : Q \geq 275 + \frac{5}{2} C$ $C < 10\text{pF} : Q \geq 200 + 10C$																											
I.R.	1,000MΩ min.																											

Continued on the following page. ↗

## Specifications and Test Methods

Continued from the preceding page.

No.	Item	Specifications	Test Method										
16	High Temperature Load	<p>The measured and observed characteristics should satisfy the specifications in the following table.</p> <table border="1"> <thead> <tr> <th>Item</th> <th>Specifications</th> </tr> </thead> <tbody> <tr> <td>Appearance</td> <td>No marked defect</td> </tr> <tr> <td>Capacitance Change</td> <td>Within <math>\pm 3\%</math> or <math>\pm 0.3\text{pF}</math> (Whichever is larger)</td> </tr> <tr> <td>Q</td> <td><math>C \geq 30\text{pF} : Q \geq 350</math> <math>10\text{pF} \leq C &lt; 30\text{pF} : Q \geq 275 + \frac{C}{10}</math> <math>C &lt; 10\text{pF} : Q \geq 200 + 10C</math></td> </tr> <tr> <td>I.R.</td> <td>1,000M<math>\Omega</math> min.</td> </tr> </tbody> </table> <p style="text-align: center;">C : Nominal Capacitance (pF)</p>	Item	Specifications	Appearance	No marked defect	Capacitance Change	Within $\pm 3\%$ or $\pm 0.3\text{pF}$ (Whichever is larger)	Q	$C \geq 30\text{pF} : Q \geq 350$ $10\text{pF} \leq C < 30\text{pF} : Q \geq 275 + \frac{C}{10}$ $C < 10\text{pF} : Q \geq 200 + 10C$	I.R.	1,000M $\Omega$ min.	<p>Apply 200% of the rated voltage for 1,000<math>\pm</math>12 hours at 125<math>\pm</math>3<math>^{\circ}</math>C. Remove and let sit for 24<math>\pm</math>2 hours at room temperature, then measure.</p> <p>The charge/discharge current is less than 50mA.</p>
Item	Specifications												
Appearance	No marked defect												
Capacitance Change	Within $\pm 3\%$ or $\pm 0.3\text{pF}$ (Whichever is larger)												
Q	$C \geq 30\text{pF} : Q \geq 350$ $10\text{pF} \leq C < 30\text{pF} : Q \geq 275 + \frac{C}{10}$ $C < 10\text{pF} : Q \geq 200 + 10C$												
I.R.	1,000M $\Omega$ min.												

Table A

Char. Code	Temperature Coefficient (ppm/ $^{\circ}$ C) Note 1	Capacitance Change from 25 $^{\circ}$ C Value (%)					
		-55 $^{\circ}$ C		-30 $^{\circ}$ C		-10 $^{\circ}$ C	
		Max.	Min.	Max.	Min.	Max.	Min.
5C	0 $\pm$ 30	0.58	-0.24	0.40	-0.17	0.25	-0.11

Note 1 : Nominal values denote the temperature coefficient within a range of 25 to 125 $^{\circ}$ C.



## ERA/ERD/ERF/ERH Series Data

### ■ Q-Frequency Characteristics

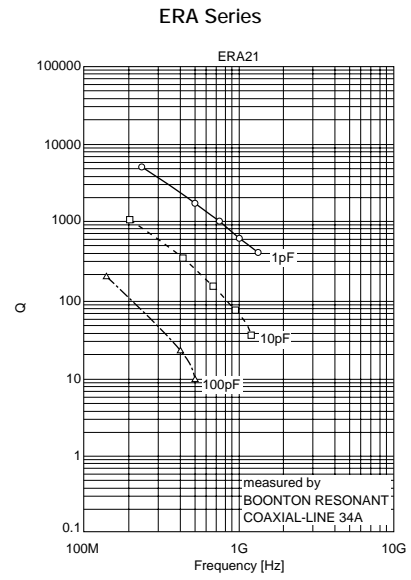
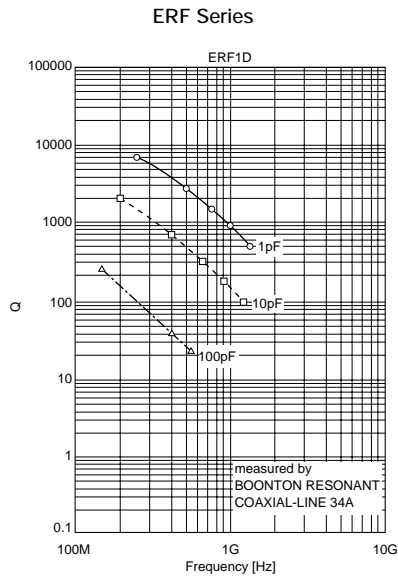

### ■ Impedance-Frequency Characteristics

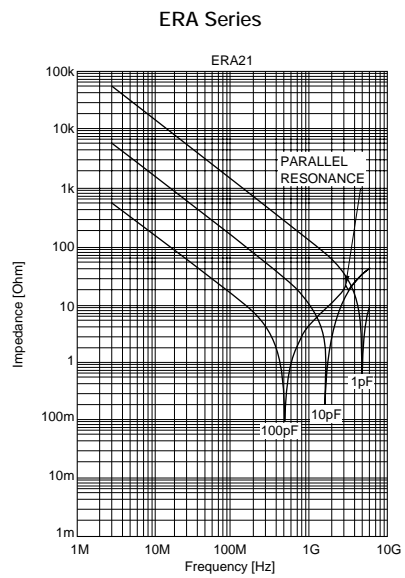
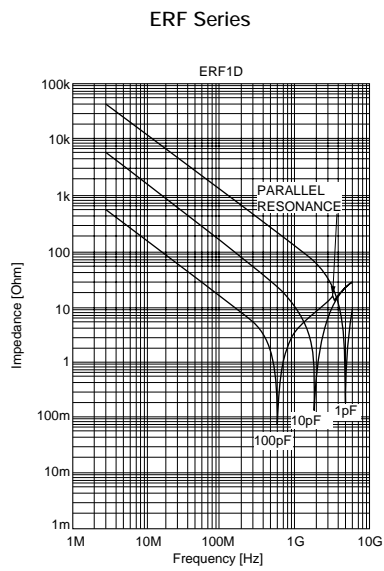

### ■ ESR-Frequency Characteristics

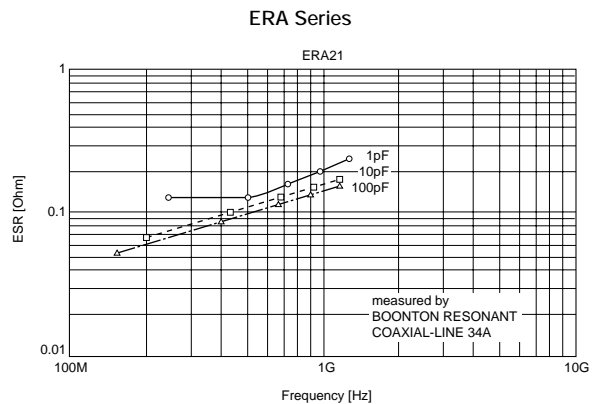
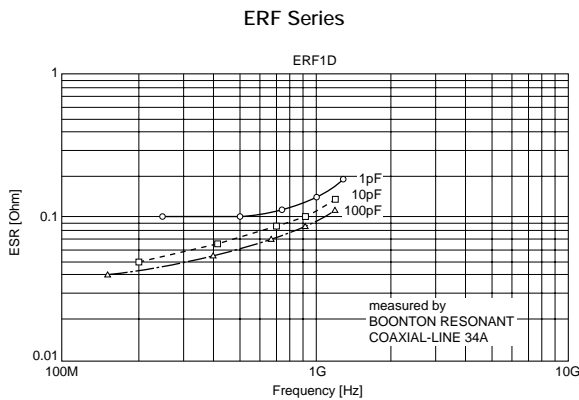

Continued on the following page. ↗

## ERA/ERD/ERF/ERH Series Data

Continued from the preceding page.

### Resonant Frequency-Capacitance

ERF Series

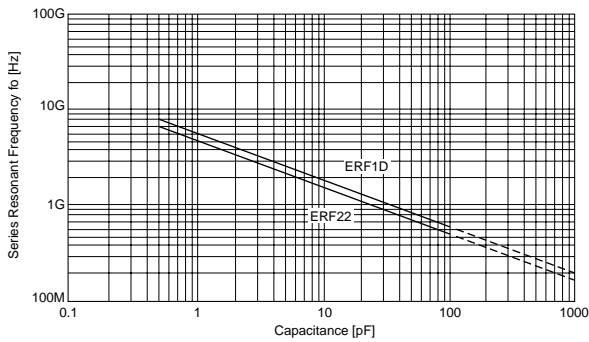

ERA Series

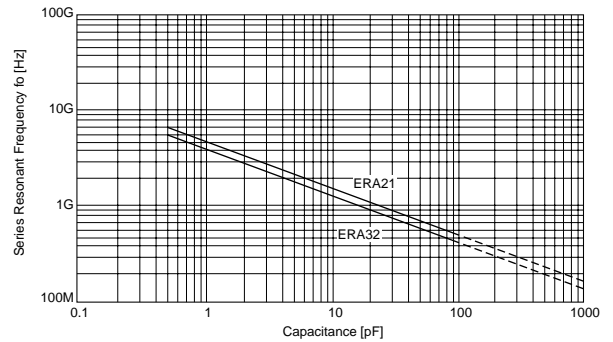

### Allowable Voltage-Frequency

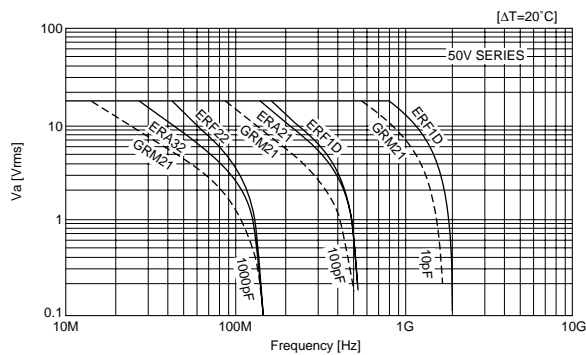

### Allowable Current-Frequency

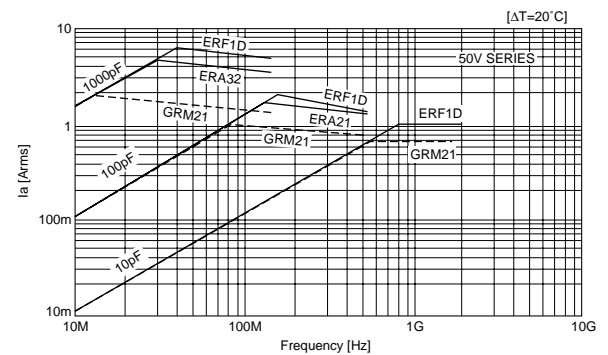

### Allowable Apparent Power-Frequency

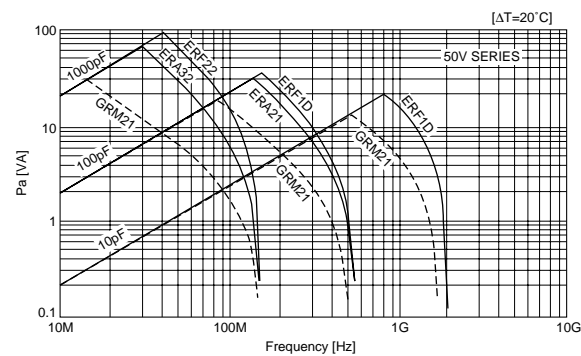

### Allowable Effective Power-Frequency

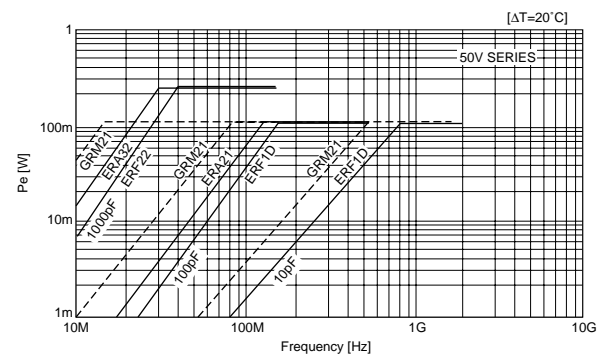

## Package

### ■ Packaging Code

Packaging Type	Tape Carrier Packaging	Bulk Case Packaging	Bulk Packaging	
			Bulk Packaging in a bag	Bulk Packaging in a tray
Packaging Code	<b>D, L, K, J, E, F</b>	<b>C</b>	<b>B</b>	<b>T</b>

### ■ Minimum Quantity Guide

Part Number	Dimensions (mm)			Quantity (pcs.)							
				ø180mm reel		ø330mm reel		Bulk Case	Bulk Bag		
	L	W	T	Paper Tape	Plastic Tape	Paper Tape	Plastic Tape				
Ultra Miniaturized	<b>GRM03</b>	0.6	0.3	0.3	15,000	-	50,000	-	-	1,000	
For Flow/Reflow	<b>GRM18</b>	1.6	0.8	0.8	4,000	-	10,000	-	15,000	1,000	
	<b>GRM21</b>	2.0	1.25	0.6	4,000	-	10,000	-	10,000	1,000	
				0.85	4,000	-	10,000	-	-	1,000	
				1.0	-	3,000	-	10,000	-	1,000	
				1.25	-	3,000	-	10,000	5,000 <sup>3)</sup>	1,000	
	<b>GRM31</b>	3.2	1.6	0.6	4,000	-	10,000	-	-	1,000	
				0.85	4,000	-	10,000	-	-	1,000	
				1.15	-	3,000	-	10,000	-	1,000	
				1.6	-	2,000	-	6,000	-	1,000	
	For Reflow	<b>GRM155</b>	1.0	0.5	0.5	10,000	-	50,000	-	50,000	1,000
<b>GRM15X</b>		1.0	0.5	0.25	10,000	-	50,000	-	-	1,000	
<b>GRM32</b>		3.2	2.5	1.15	-	3,000	-	10,000	-	-	1,000
				1.35	-	2,000	-	8,000	-	-	1,000
				1.8/1.6	-	1,000	-	4,000	-	-	1,000
				2.0	-	1,000	-	4,000	-	-	1,000
				2.5	-	1,000	-	4,000	-	-	1,000
<b>GRM43</b>		4.5	3.2	1.15	-	1,000	-	5,000	-	-	1,000
				1.35/1.6	-	1,000	-	4,000	-	-	1,000
				1.8/2.0	-	500	-	2,000	-	-	1,000
				2.5	-	500	-	2,000	-	-	1,000
<b>GRM55</b>		5.7	5.0	1.15	-	1,000	-	5,000	-	-	1,000
				1.35/1.6	-	1,000	-	4,000	-	-	1,000
				1.8/2.0	-	500	-	2,000	-	-	500
				3.2	-	300	-	1,500	-	-	500
High Power Type	<b>GJM03</b>	0.6	0.3	0.3	15,000	-	50,000	-	-	1,000	
	<b>GJ6/GJM15</b>	1.0	0.5	0.5	10,000	-	50,000	-	50,000	1,000	
Smoothing <sup>1)</sup>	<b>GJ221</b>	2.0	1.25	1.25	-	3,000	-	10,000	-	-	
	<b>GJ231</b>	3.2	1.6	1.15	-	3,000	-	10,000	-	-	
				1.35	-	2,000	-	8,000	-	-	
	<b>GJ232</b>	3.2	2.5	1.6	-	2,000	-	6,000	-	-	
				1.8	-	1,000	-	4,000	-	-	
	<b>GJ243</b>	4.5	3.2	1.8	-	1,000	-	3,000	-	-	
2.2				-	500	-	2,000	-	-		
High Frequency	<b>GQM18</b>	1.6	0.8	0.8	4,000	-	10,000	-	-	1,000	
	<b>GQM21</b>	2.0	1.25	0.85	4,000	-	10,000	-	-	1,000	
	<b>ERA11</b>	1.25	1.0	1.0	-	-	-	-	-	1,000	
	<b>ERA21</b>	2.0	1.25	1.0/1.25	-	3,000	-	-	-	1,000	
	<b>ERA32</b>	3.2	2.5	1.7	-	2,000	-	-	-	1,000	
	<b>ERF1D</b>	1.4	1.4	1.15	-	2,000	-	-	-	1,000	
	<b>ERF22</b>	2.8	2.8	2.3	-	1,000	-	-	-	1,000	
For Ultrasonic	<b>GRM21</b>	2.0	1.25	0.85	4,000	-	10,000	-	-	1,000	
Micro Chip	<b>GMA05</b>	0.5	0.5	0.35	-	-	-	-	-	400 <sup>2)</sup>	
	<b>GMA08</b>	0.8	0.8	0.5	-	-	-	-	-	400 <sup>2)</sup>	
Array	<b>GNM1M</b>	1.37	1.0	0.6	4,000	-	10,000	-	-	1,000	
	<b>GNM31</b>	3.2	1.6	0.8	4,000	-	10,000	-	-	1,000	
				1.0	-	3,000	-	10,000	-	1,000	
	<b>GNM21</b>	2.0	1.25	0.6/0.85	4,000	-	10,000	-	-	1,000	
Low ESL	<b>LLL18</b>	0.8	1.6	0.6	4,000	-	10,000	-	-	1,000	
	<b>LLL21</b>	1.25	2.0	0.6	-	4,000	-	10,000	-	1,000	
				0.85	-	3,000	-	10,000	-	1,000	
	<b>LLL31</b>	1.6	3.2	0.7	-	4,000	-	10,000	-	1,000	
				1.15	-	3,000	-	10,000	-	1,000	

1) Available in tape/reel only. 2) Tray 3) 3.3/4.7µF of 6.3 R6 rated are not available by bulk case.



## Package

☑ Continued from the preceding page.

### (3) Dimensions of Plastic Tape

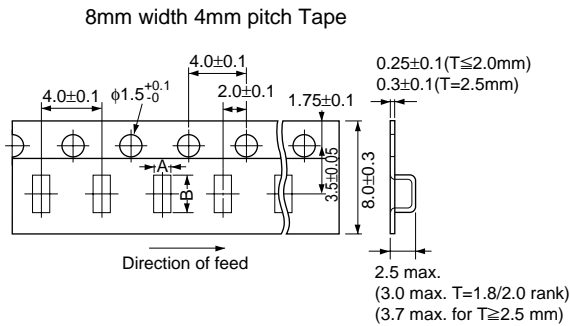

Part Number	A	B
<b>LLL18</b>	1.05±0.1	1.85±0.1
<b>GRM21</b> (T≥1.0mm) <b>LLL21, GJ221</b>	1.45±0.2	2.25±0.2
<b>GRM31</b> (T≥1.15mm) <b>LLL31</b> <b>GJM31</b> (T≥1.0mm) <b>GJ231</b>	1.9±0.2	3.5±0.2
<b>GRM32</b> (T≥1.15mm) <b>GJ232</b>	2.8±0.2	3.5±0.2
<b>ERA21</b>	1.8*	2.6*
<b>ERA32</b>	2.8*	3.5*
<b>ERF1D</b>	2.0*	2.1*
<b>ERF22</b>	3.1*	3.2*

\*Nominal Value

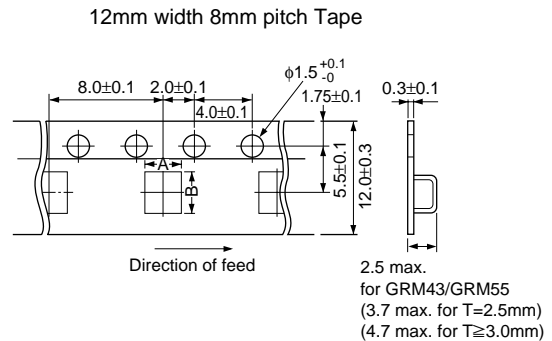

Part Number	A*	B*
<b>GRM43, GJ243</b>	3.6	4.9
<b>GRM55</b>	5.2	6.1

\*Nominal Value

(in mm)

### (4) Taping Method

- ① Tapes for capacitors are wound clockwise. The sprocket holes are to the right as the tape is pulled toward the user.
- ② Part of the leader and part of the empty tape should be attached to the end of the tape as follows.
- ③ The top tape and base tape are not attached at the end of the tape for a minimum of 5 pitches.
- ④ Missing capacitors number within 0.1% of the number per reel or 1 pc, whichever is greater, and are not continuous.
- ⑤ The top tape and bottom tape should not protrude beyond the edges of the tape and should not cover sprocket holes.
- ⑥ Cumulative tolerance of sprocket holes, 10 pitches : ±0.3mm.
- ⑦ Peeling off force : 0.1 to 0.6N\* in the direction shown below.
 

*GRM03	} : 0.05 to 0.5N
GJM03	

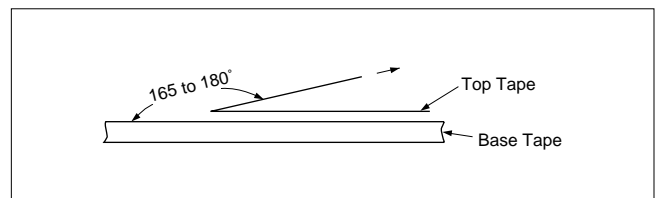
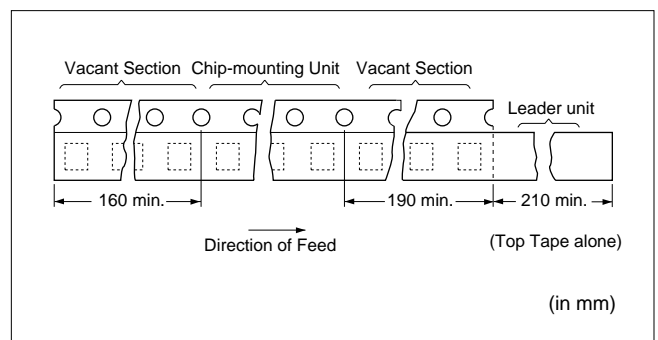

Continued on the following page. ☑

## Package

☐ Continued from the preceding page.

### ■ Dimensions of Bulk Case Packaging

The bulk case uses antistatic materials. Please contact Murata for details.

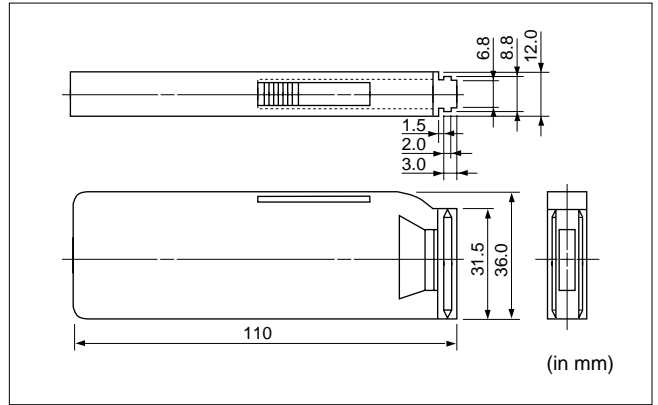



## ■ Storage and Operating Conditions

Chip monolithic ceramic capacitors (chips) can experience degradation of termination solderability when subjected to high temperature or humidity, or if exposed to sulfur or chlorine gases.

Storage environment must be at an ambient temperature of 5-40 degree C and an ambient humidity of 20-70%RH.

Use chip within 6 months. If 6 months or more have elapsed, check solderability before use.

(Reference Data 1. Solderability)

**FAILURE TO FOLLOW THE ABOVE CAUTIONS MAY RESULT, WORST CASE, IN A SHORT CIRCUIT AND FUMING WHEN THE PRODUCTS IS USED.**

## ■ Handling

### 1. Inspection

Thrusting force of the test probe can flex the PCB, resulting in cracked chips or open solder joints. Provide support pins on the back side of the PCB to prevent warping or flexing.

### 2. Board Separation (or depanelization)

(1) Board flexing at the time of separation causes cracked chips or broken solder.

(2) Severity of stresses imposed on the chip at the time of board break is in the order of :  
Pushback<Slitter<V Slot<Perforator.

(3) Board separation must be performed using special jigs, not with hands.

### 3. Reel and bulk case

In the handling of reel and case, please be careful and do not drop it.

Please do not use chips from a case which has been dropped.

**FAILURE TO FOLLOW THE ABOVE CAUTIONS MAY RESULT, WORST CASE, IN A SHORT CIRCUIT AND FUMING WHEN THE PRODUCTS IS USED.**

## ⚠️Caution

### ■ Soldering and Mounting

#### 1. Mounting Position

Choose a mounting position that minimizes the stress imposed on the chip during flexing or bending of the board.

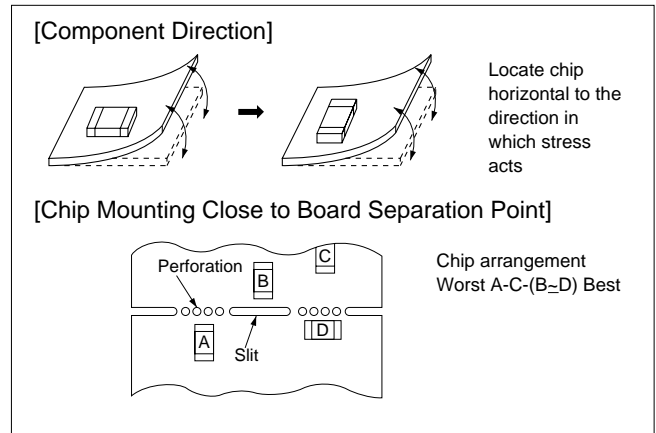

(Reference Data 2. Board bending strength for solder fillet height)

(Reference Data 3. Temperature cycling for solder fillet height)

(Reference Data 4. Board bending strength for board material)

#### 2. Solder Paste Printing

- Overly thick application of solder paste results in excessive fillet height solder. This makes the chip more susceptible to mechanical and thermal stress on the board and may cause cracked chips.
- Too little solder paste results in a lack of adhesive strength on the outer electrode, which may result in chips breaking loose from the PCB.
- Make sure the solder has been applied smoothly to the end surface to a height of 0.2mm min.

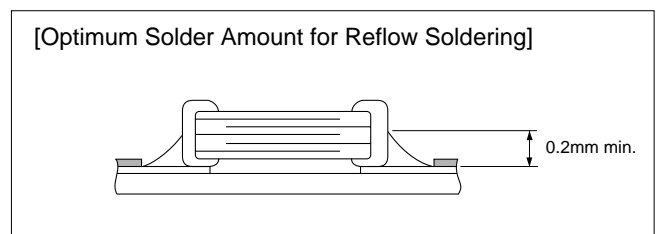

#### 3. Chip Placing

- An excessively low bottom dead point of the suction nozzle imposes great force on the chip during mounting, causing cracked chips. So adjust the suction nozzle's bottom dead point by correcting warp in the board. Normally, the suction nozzle's bottom dead point must be set on the upper surface of the board. Nozzle pressure for chip mounting must be a 1 to 3N static load.
- Dirt particles and dust accumulated between the suction nozzle and the cylinder inner wall prevent the nozzle from moving smoothly. This imposes great force on the chip during mounting, causing cracked chips. And the locating claw, when worn out, imposes uneven forces on the chip when positioning, causing cracked chips. The suction nozzle and the locating claw must be maintained, checked and replaced periodically.

(Reference Data 5. Break strength)

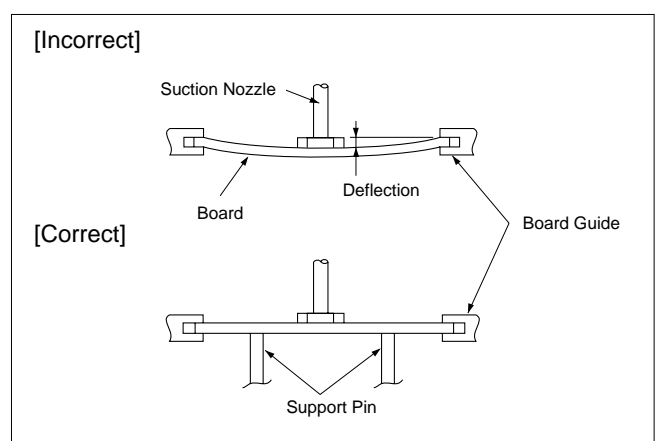

Continued on the following page. ↗





☐ Continued from the preceding page.

#### 4. Reflow Soldering

- Sudden heating of the chip results in distortion due to excessive expansion and construction forces within the chip causing cracked chips. So when preheating, keep temperature differential,  $\Delta T$ , within the range shown in Table 1. The smaller the  $\Delta T$ , the less stress on the chip.
- When components are immersed in solvent after mounting, be sure to maintain the temperature difference ( $\Delta T$ ) between the component and solvent within the range shown in the above table.

Table 1

Part Number	Temperature Differential
GRM03/15/18/21/31 GJ615, GJ221/31 LLL18/21/31 ERA11/21/32, ERF1D GQM18/21	$\Delta T \leq 190^\circ\text{C}$
GRM32/43/55 GNM, GJ232/43 ERA32, ERF22	$\Delta T \leq 130^\circ\text{C}$

#### Inverting the PCB

Make sure not to impose an abnormal mechanical shock on the PCB.

#### 5. Leaded Component Insertion

If the PCB is flexed when leaded components (such as transformers and ICs) are being mounted, chips may crack and solder joints may break.

Before mounting leaded components, support the PCB using backup pins or special jigs to prevent warping.

#### [Standard Conditions for Reflow Soldering]

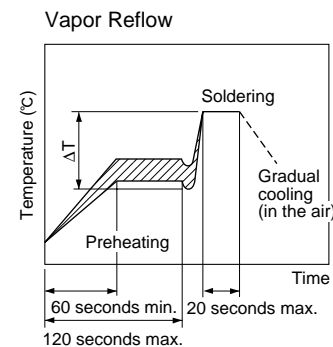
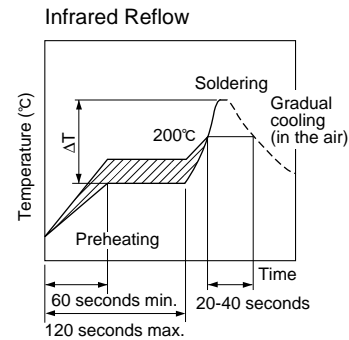

#### [Allowable Soldering Temperature and Time]

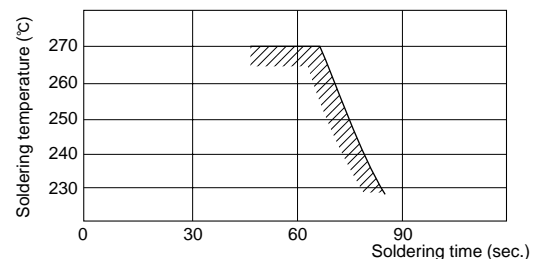

In case of repeated soldering, the accumulated soldering time must be within the range shown above.

Continued on the following page. ☐

## ⚠ Caution

☐ Continued from the preceding page.

### 6. Flow Soldering

- Sudden heating of the chip results in thermal distortion causing cracked chips. And an excessively long soldering time or high soldering temperature results in leaching of the outer electrodes, causing poor adhesion or a reduction in capacitance value due to loss of contact between electrodes and end termination.
- When preheating, keep the temperature differential between solder temperature and chip surface temperature,  $\Delta T$ , within the range shown in Table 2. The smaller the  $\Delta T$ , the less stress on the chip. When components are immersed in solvent after mounting, be sure to maintain the temperature difference between the component and solvent within the range shown in Table 2. Do not apply flow soldering to chips not listed in Table 5.

Table 2

Part Number	Temperature Differential
GRM18/21/31 LLL21/31 ERA11/21, ERF1D GQM18/21	$\Delta T \leq 150^\circ\text{C}$

- Optimum Solder Amount for Flow Soldering

[Standard Conditions for Flow Soldering]

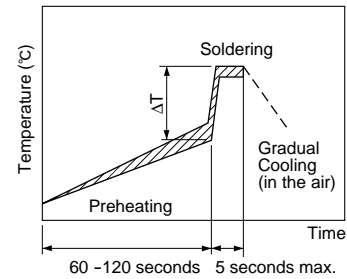

[Allowable Soldering Temperature and Time]

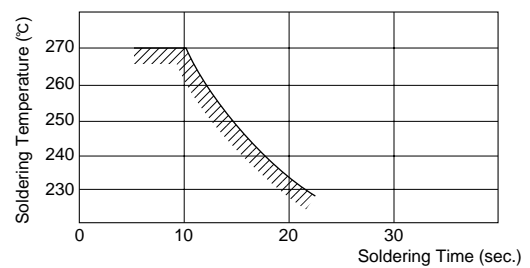

In case of repeated soldering, the accumulated soldering time must be within the range shown above.

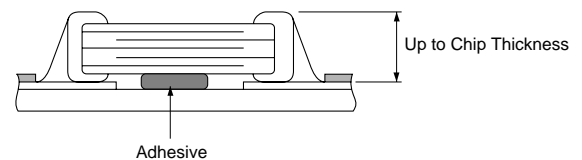

Continued on the following page. ☐

**⚠ Caution**

☐ Continued from the preceding page.

**7. Correction with a Soldering Iron**

(1) For Chip Type Capacitors <Except GJ2 Series>

- Sudden heating of the chip results in distortion due to a high internal temperature differential, causing cracked chips. When preheating, keep temperature differential,  $\Delta T$ , within the range shown in Table 3. The smaller the  $\Delta T$ , the less stress on the chip.

Table 3

Part Number	Temperature Differential
GRM15/18/21/31 GJ615 LLL18/21/31 GQM18/21 ERA11/21, ERF1D	$\Delta T \leq 190^\circ\text{C}$
GRM32/43/55 GNM ERA32, ERF22	$\Delta T \leq 130^\circ\text{C}$

[Standard Conditions for Soldering Iron Temperature]

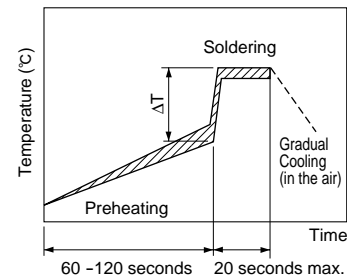

[Allowable Time and Temperature for Making Corrections with a Soldering Iron]

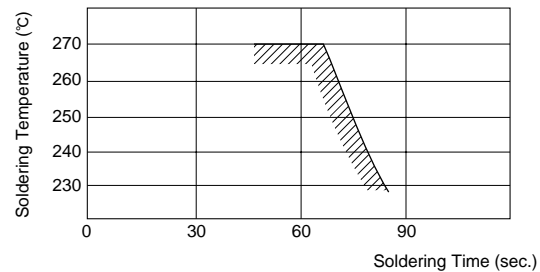

The accumulated soldering Time / temperature including reflow / flow soldering must be within the range shown above.

- Optimum Solder Amount when Corrections Are Made Using a Soldering Iron

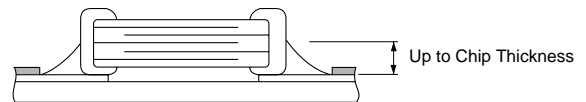

(2) For GJ2 Series

- When solder GJ2 series chip capacitor, keep the following conditions.

<Soldering iron method>

Part Number	Pre-heating	Temperature of iron tip	Soldering iron wattage	Diameter of iron tip	Soldering time	Soldering amount	Restriction
GJ221/31/32/43	$\Delta \leq 130^\circ\text{C}$	300°C max.	20W max.	$\phi$ 3mm max.	5 sec. max.	$\leq 1/2$ of chip thickness	Do not allow the iron tip to directly touch the ceramic element.

(3) For Microstrip Types

- Solder 1mm away from the ribbon terminal base, being careful that the solder tip does not directly contact the capacitor. Preheating is unnecessary.
- Complete soldering within 3 seconds with a soldering tip less than 270°C in temperature.

Continued on the following page. ☐

## **Caution**

 Continued from the preceding page.

### **8. Washing**

Excessive output of ultrasonic oscillation during cleaning causes PCBs to resonate, resulting in cracked chips or broken solder. Take note not to vibrate PCBs.

Failure to follow the above cautions may result, worst case, in a short circuit and fuming when the product is used.

## Notice

### ■ Rating

#### Die Bonding/Wire Bonding (GMA Series)

##### 1. Die Bonding of Capacitors

- Use the following materials Braze alloy :
  - Au-Si (98/2) 400 to 420 degree C in N2 atmosphere
  - Au-Sn (80/20) 300 to 320 degree C in N2 atmosphere
  - Au-Ge (88/12) 380 to 400 degree C in N2 atmosphere

##### •Mounting

- (1) Control the temperature of the substrate so that it matches the temperature of the braze alloy.
- (2) Place braze alloy on substrate and place the capacitor on the alloy. Hold the capacitor and

gently apply the load. Be sure to complete the operation in 1 minute.

##### 2. Wire Bonding

##### •Wire

Gold wire :  
20mm (0.0008 inch), 25mm (0.001 inch) diameter

##### •Bonding

- (1) Thermocompression, ultrasonic ball bonding.
- (2) Required stage temperature : 150 to 250 degree C
- (3) Required wedge or capillary weight : 0.5N to 2N.
- (4) Bond the capacitor and base substrate or other devices with gold wire.

## Notice

### ■ Soldering and Mounting

#### 1. PCB Design

##### (1) Notice for Pattern Forms

Unlike leaded components, chip components are susceptible to flexing stresses since they are mounted directly on the substrate.

They are also more sensitive to mechanical and thermal stresses than leaded components.

Excess solder fillet height can multiply these stresses and cause chip cracking. When designing substrates, take land patterns and dimensions into consideration to eliminate the possibility of excess solder fillet height.

#### Pattern Forms

	Placing Close to Chassis	Placing of Chip Components and Leaded Components	Placing of Leaded Components after Chip Component	Lateral Mounting
Incorrect				
Correct				

Continued on the following page. ↗

**Notice**

☐ Continued from the preceding page.

(2) Land Dimensions

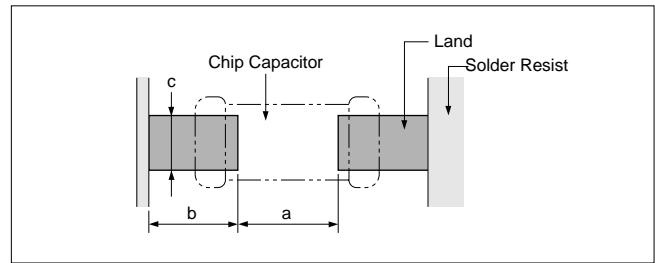

Table 1 Flow Soldering Method

Part Number	Dimensions	Dimensions (L×W)	a	b	c
GRM18 GQM18		1.6×0.8	0.6–1.0	0.8–0.9	0.6–0.8
GRM21 GQM21		2.0×1.25	1.0–1.2	0.9–1.0	0.8–1.1
GRM31		3.2×1.6	2.2–2.6	1.0–1.1	1.0–1.4
LLL21		1.25×2.0	0.4–0.7	0.5–0.7	1.4–1.8
LLL31		1.6×3.2	0.6–1.0	0.8–0.9	2.6–2.8
ERA11		1.25×1.0	0.4–0.6	0.6–0.8	0.8–1.0
ERA21		2.0×1.25	1.0–1.2	0.9–1.0	0.8–1.0
ERF1D		1.4×1.4	0.5–0.8	0.8–0.9	1.0–1.2

(in mm)

Table 2 Reflow Soldering Method

Part Number	Dimensions	Dimensions (L×W)	a	b	c
GRM03		0.6×0.3	0.2–0.3	0.2–0.35	0.2–0.4
GRM15		1.0×0.5	0.3–0.5	0.35–0.45	0.4–0.6
GRM18 GQM18		1.6×0.8	0.6–0.8	0.6–0.7	0.6–0.8
GRM21 GQM21 GJ221		2.0×1.25	1.0–1.2	0.6–0.7	0.8–1.1
GRM31 GJ231		3.2×1.6	2.2–2.4	0.8–0.9	1.0–1.4
GRM32 GJ232		3.2×2.5	2.0–2.4	1.0–1.2	1.8–2.3
GRM43 GJ243		4.5×3.2	3.0–3.5	1.2–1.4	2.3–3.0
GRM55		5.7×5.0	4.0–4.6	1.4–1.6	3.5–4.8
LLL18		0.8×1.6	0.2–0.4	0.3–0.4	1.0–1.4
LLL21		1.25×2.0	0.4–0.6	0.3–0.5	1.4–1.8
LLL31		1.6×3.2	0.6–0.8	0.6–0.7	2.6–2.8
ERA11		1.25×1.0	0.4–0.6	0.6–0.8	0.8–1.0
ERA21		2.0×1.25	1.0–1.2	0.6–0.8	0.8–1.0
ERA32		3.2×2.5	2.2–2.5	0.8–1.0	1.9–2.3
ERF1D		1.4×1.4	0.4–0.8	0.6–0.8	1.0–1.2
ERF22		2.8×2.8	1.8–2.1	0.7–0.9	2.2–2.6

(in mm)

Continued on the following page. ☐

## Notice

☞ Continued from the preceding page.

### ● GNM Series for reflow soldering method

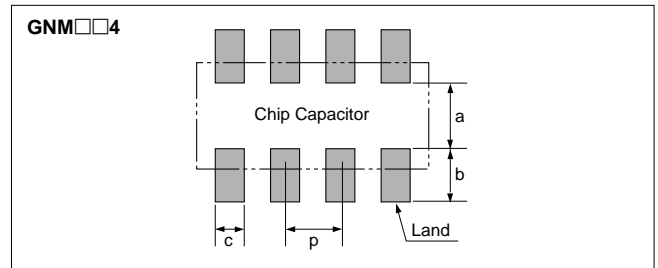
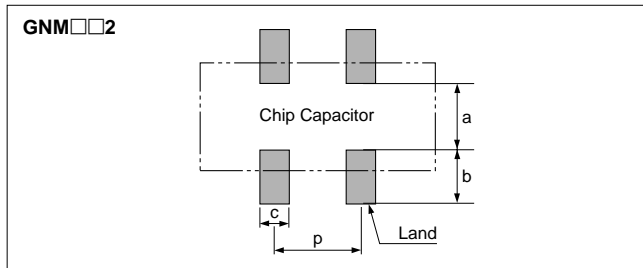
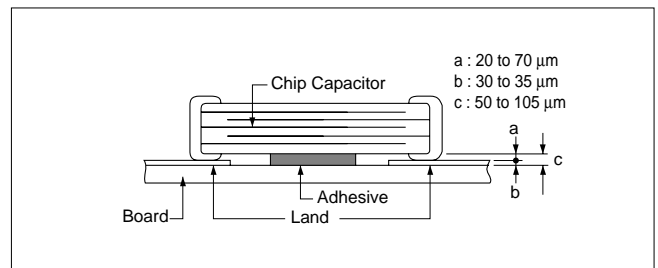

Table 3

Part Number	Dimensions (mm)					
	L	W	a	b	c	p
<b>GNM1M2</b>	1.37	1.0	0.45~0.5	0.5~0.55	0.3~0.35	0.64+/-0.1
<b>GNM212</b>	2.0	1.25	0.6~0.7	0.5~0.7	0.4~0.5	1.0+/-0.1
<b>GNM214</b>	2.0	1.25	0.6~0.7	0.5~0.7	0.25~0.35	0.5+/-0.05
<b>GNM314</b>	3.2	1.6	0.8~1.0	0.7~0.9	0.3~0.4	0.8+/-0.05

## 2. Adhesive Application

- Thin or insufficient adhesive causes chips to loosen or become disconnected when flow soldered. The amount of adhesive must be more than dimension C shown in the drawing below to obtain enough bonding strength. The chip's electrode thickness and land thickness must be taken into consideration.
- Low viscosity adhesive causes chips to slip after mounting. Adhesive must have a viscosity of 5000Pa•s (500ps) min. (at 25°C)
- Adhesive Coverage\*



Part Number	Adhesive Coverage*
<b>GRM18</b>	0.05mg Min.
<b>GQM18</b>	
<b>GRM21</b>	0.1mg Min.
<b>GQM21</b>	
<b>GRM31</b>	0.15mg Min.

\*Nominal Value

## 3. Adhesive Curing

Insufficient curing of the adhesive causes chips to disconnect during flow soldering and causes deteriorated insulation resistance between outer electrodes due to moisture absorption.

Control curing temperature and time in order to prevent insufficient hardening.

### Inverting the PCB

Make sure not to impose an abnormal mechanical shock on the PCB.

Continued on the following page. ☞



## Notice

☐ Continued from the preceding page.

### 4. Flux Application

- An excessive amount of flux generates a large quantity of flux gas, causing deteriorated solderability. So apply flux thinly and evenly throughout. (A foaming system is generally used for flow soldering).
- Flux containing too high a percentage of halide may cause corrosion of the outer electrodes unless sufficiently

cleaned. Use flux with a halide content of 0.2wt% max.  
But do not use strong acidic flux.  
Wash thoroughly because water soluble flux causes deteriorated insulation resistance between outer electrodes unless sufficiently cleaned.

### 5. Flow Soldering

- Set temperature and time to ensure that leaching of the outer electrode does not exceed 25% of the chip end area as a single chip (full length of the edge A-B-C-D shown below) and 25% of the length A-B shown below as mounted on substrate.

[As a Single Chip]

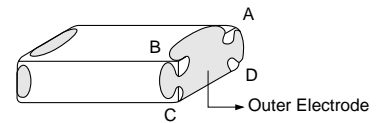

[As Mounted on Substrate]

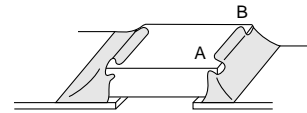

(Reference Data 6. Thermal shock)

(Reference Data 7. Solder heat resistance)

## Notice

### ■ Others

#### 1. Resin Coating

When selecting resin materials, select those with low contraction.

#### 2. Circuit Design

The capacitors listed in the previous sections of this catalog are not safety recognized products.

#### 3. Remarks

The above notices are for standard applications and conditions. Contact us when the products are used in special mounting conditions. Select optimum conditions for operation as they determine the reliability of the product after assembly.

The data herein are given in typical values, not guaranteed ratings.

## Reference Data

### 1. Solderability

#### (1) Test Method

Subject the chip capacitor to the following conditions.  
Then apply flux (a ethanol solution of 25% rosin) to the chip and dip it in 230°C eutectic solder for 2 seconds.

Conditions :

Expose prepared at room temperature (for 6 months and 12 months, respectively)

Prepared at high temperature (for 100 hours at 85°C)

Prepared left at high humidity (for 100 hours under 90%RH to 95%RH at 40°C)

#### (2) Test Samples

GRM21 : Products for flow/reflow soldering.

#### (3) Acceptance Criteria

With a 60-power optical microscope, measure the surface area of the outer electrode that is covered with solder.

#### (4) Results

Refer to Table 1.

Table 1

Sample	Initial State	Prepared at Room Temperature		Prepared at High Temperature for 100 Hours at 85°C	Prepared at High Humidity for 100 Hours at 90 to 95% RH and 40°C
		6 months	12 months		
GRM21 for flow/reflow soldering	95 to 100%	95 to 100%	95%	90 to 95%	95%

### 2. Board Bending Strength for Solder Fillet Height

#### (1) Test Method

Solder the chip capacitor to the test PCB with the amount of solder paste necessary to achieve the fillet heights. Then bend the PCB using the method illustrated and measure capacitance.

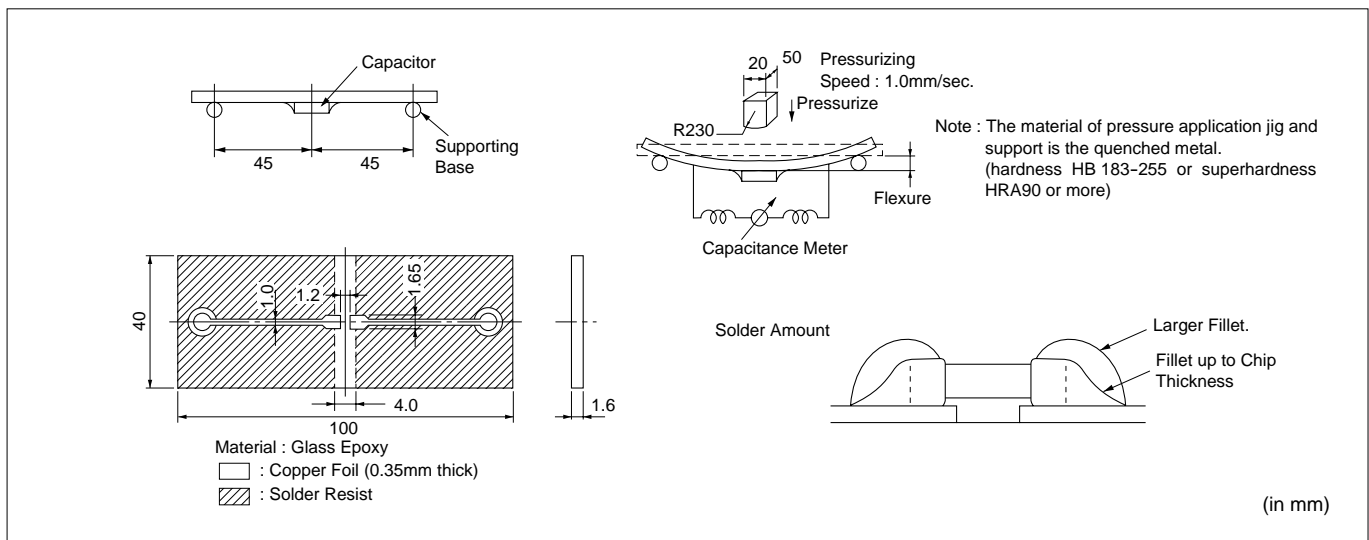

#### (2) Test Samples

GRM21 C0G/X7R/Y5V Characteristics T=0.6mm

#### (3) Acceptance Criteria

Products shall be determined to be defective if the change in capacitance has exceeded the values specified in Table 2.

Table 2

Characteristics	Change in Capacitance
C0G	Within $\pm 5\%$ or $\pm 0.5\text{pF}$ , whichever is greater
X7R	Within $\pm 12.5\%$
Y5V	Within $\pm 20\%$

Continued on the following page.

## Reference Data

☐ Continued from the preceding page.

### (4) Results

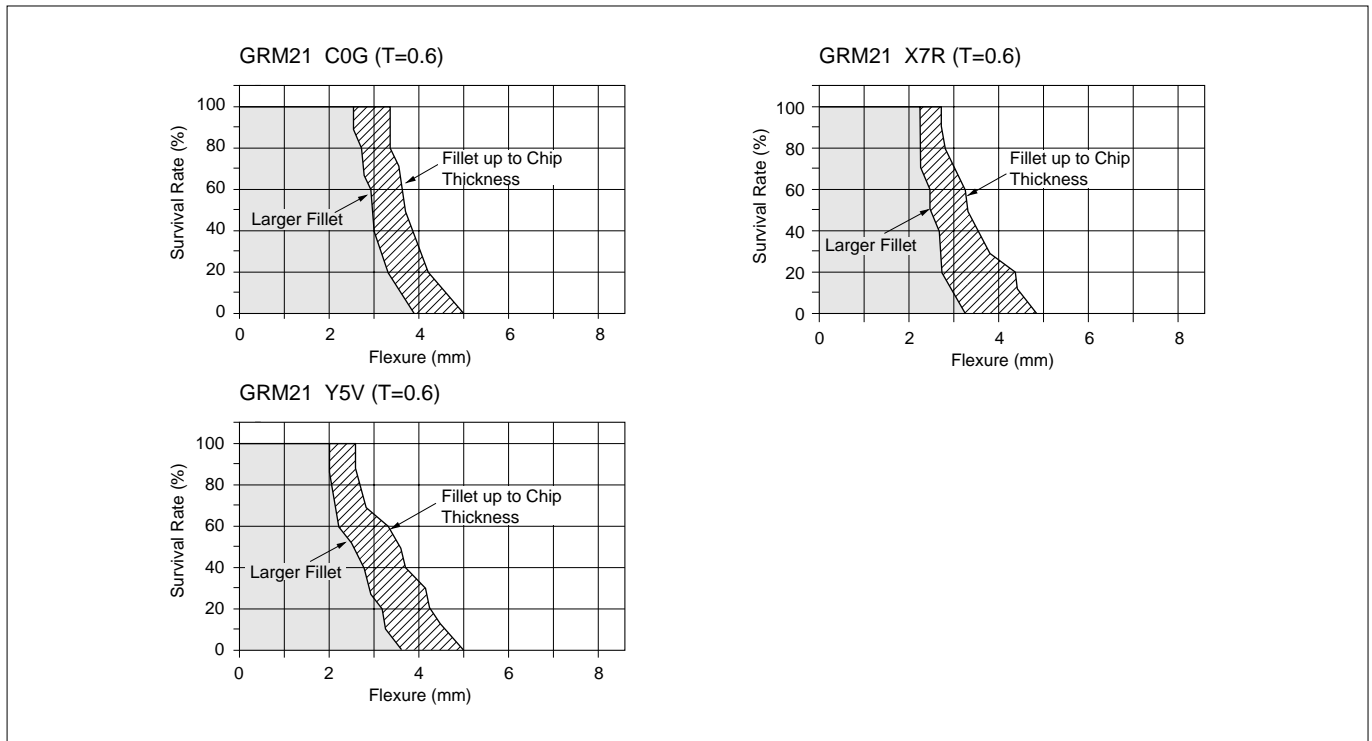

### 3. Temperature Cycling for Solder Fillet Height

#### (1) Test Method

Solder the chips to the substrate various test fixtures using sufficient amounts of solder to achieve the required fillet height. Then subject the fixtures to the cycle illustrated below 200 times.

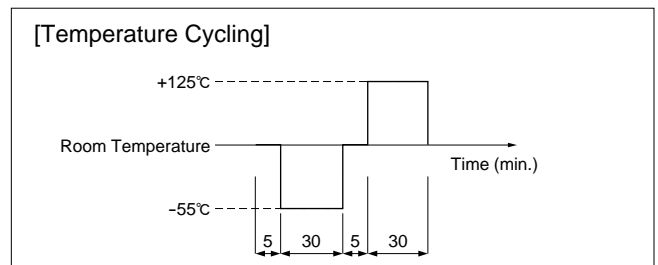

#### ① Solder Amount

Alumina substrates are typically designed for reflow soldering.

Glass epoxy or paper phenol substrates are typically used for flow soldering.

#### ② Material

- Alumina (Thickness : 0.64mm)
- Glass epoxy (Thickness : 1.6 mm)
- Paper phenol (Thickness : 1.6 mm)

Substrate		Alumina	Glass Epoxy or Paper Phenol
Solder Amount	①		
	②		
	③		
Solder to be used		6X4 Eutectic solder	

#### ③ Land Dimension

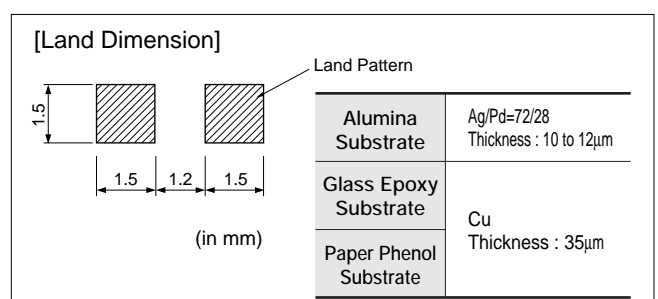

Continued on the following page. ☐

## Reference Data

↳ Continued from the preceding page.

### (2) Test Samples

GRM40 C0G/X7R/Y5V Characteristics T=0.6mm

### (3) Acceptance Criteria

Products are determined to be defective if the change in capacitance has exceeded the values specified in Table 3.

Table 3

Characteristics	Change in Capacitance
<b>C0G</b>	Within $\pm 2.5\%$ or $\pm 0.25\text{pF}$ , whichever is greater
<b>X7R</b>	Within $\pm 7.5\%$
<b>Y5V</b>	Within $\pm 20\%$

### (4) Results

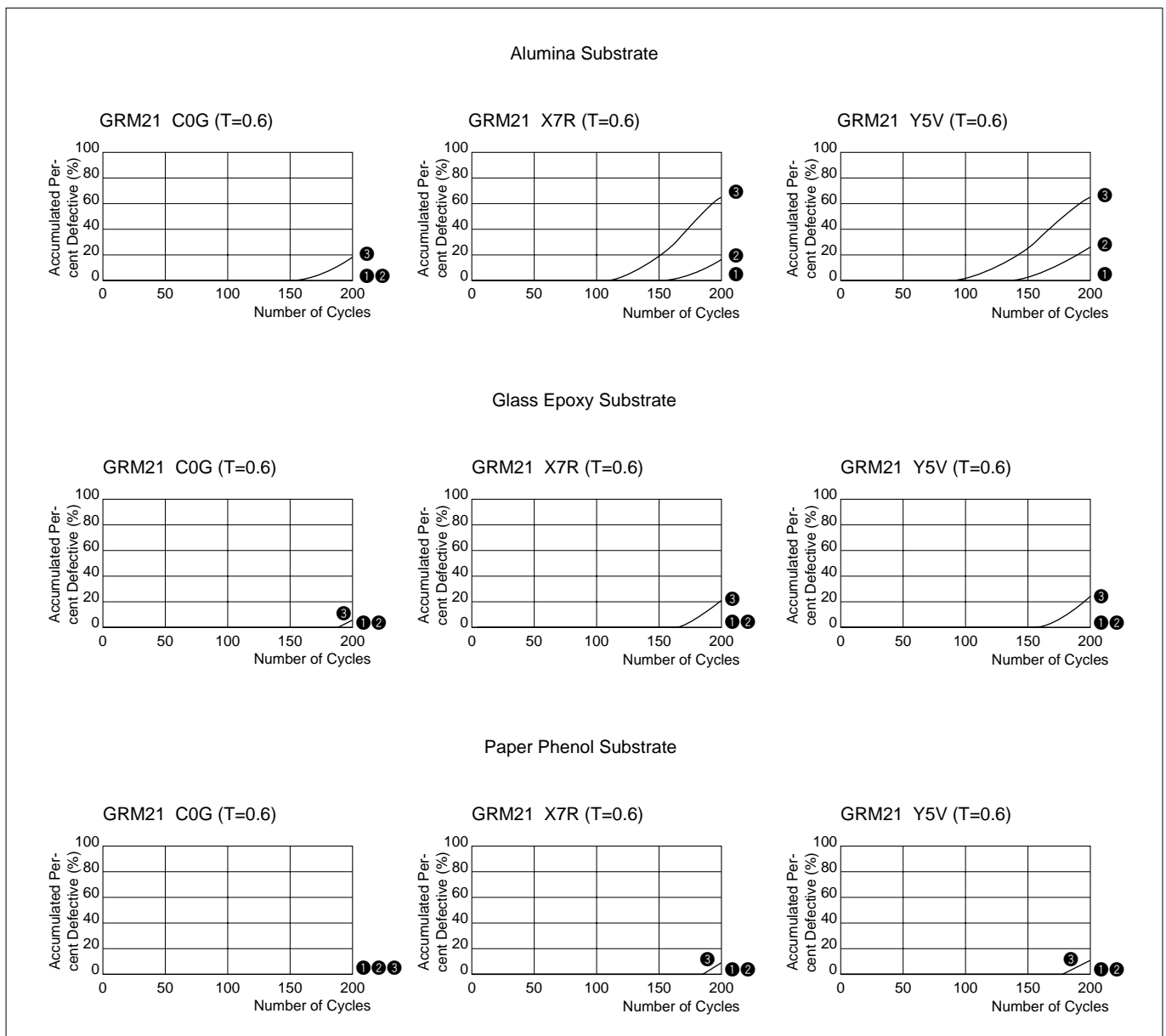

Continued on the following page. ↗

## Reference Data

☐ Continued from the preceding page.

### 4. Board Bending Strength for Board Material

#### (1) Test Method

Solder the chip to the test board. Then bend the board using the method illustrated below, to measure capacitance.

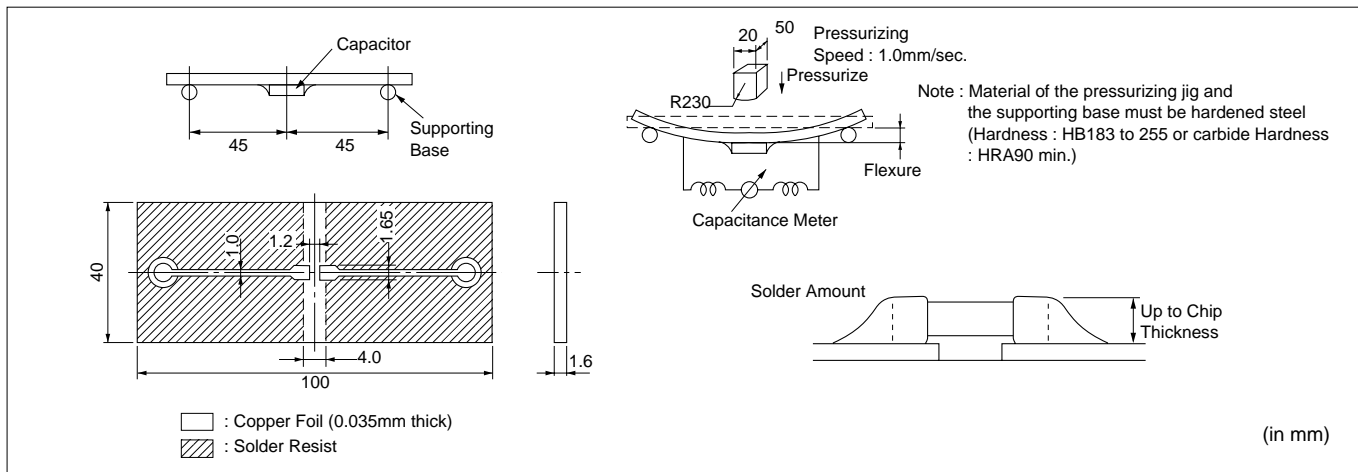

#### (2) Test Samples

GRM21 C0G/X7R/Y5V Characteristics T=0.6mm typical

#### (3) Acceptance Criteria

Products shall be determined to be defective if the change in capacitance has exceeded the values specified in Table 4.

Table 4

Characteristics	Change in Capacitance
<b>C0G</b>	Within $\pm 5\%$ or $\pm 0.5\text{pF}$ , whichever is greater
<b>X7R</b>	Within $\pm 12.5\%$
<b>Y5V</b>	Within $\pm 20\%$

#### (4) Results

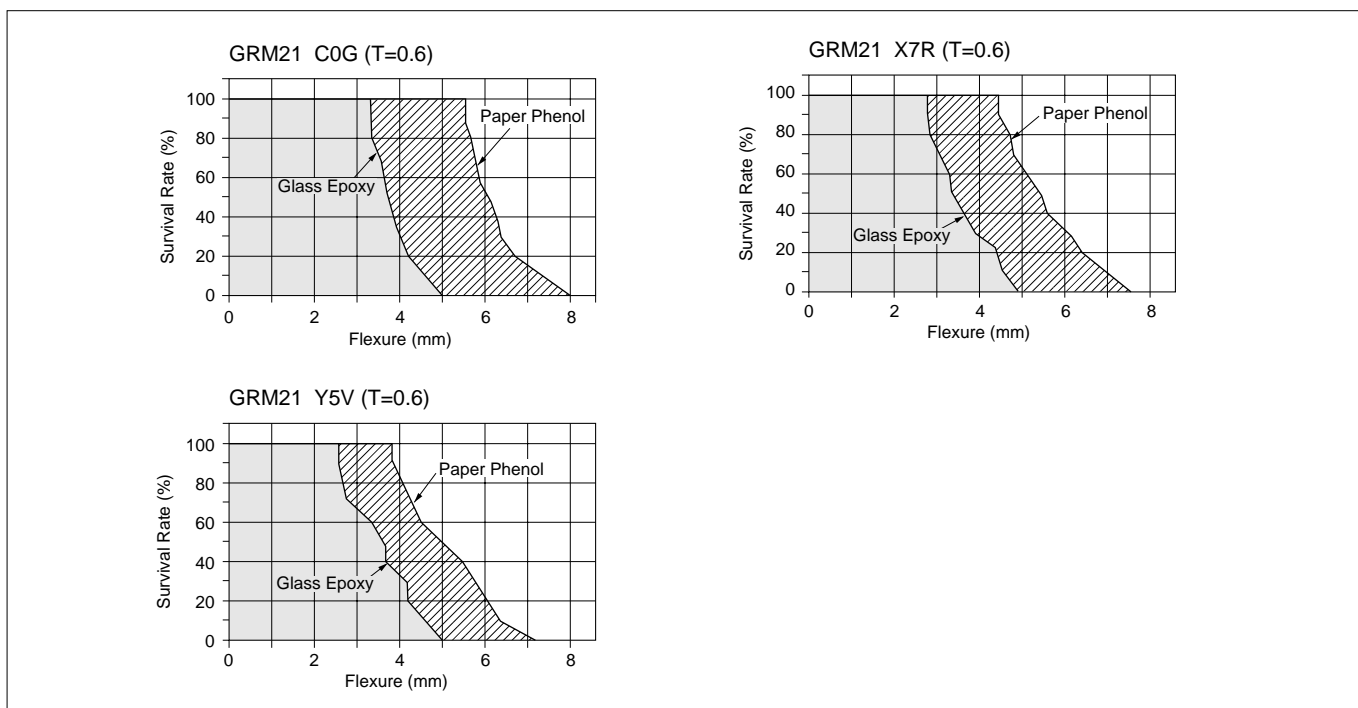

Continued on the following page. ↗

## Reference Data

☞ Continued from the preceding page.

### 5. Break Strength

#### (1) Test Method

Place the chip on a steel plate as illustrated on the right. Increase load applied to a point near the center of the test sample.

#### (2) Test Samples

GRM21 C0G/X7R/Y5V Characteristics  
GRM31 C0G/X7R/Y5V Characteristics

#### (3) Acceptance Criteria

Define the load that has caused the chip to break or crack, as the bending force.

#### (4) Explanation

Break strength, P, is proportionate to the square of the thickness of the ceramic element and is expressed as a curve of secondary degree.

The formula is :

$$P = \frac{2\gamma WT^2}{3L} \quad (\text{N})$$

W : Width of ceramic element (mm)  
T : Thickness of element (mm)  
L : Distance between fulcrums (mm)  
 $\gamma$  : Bending stress (N/mm<sup>2</sup>)

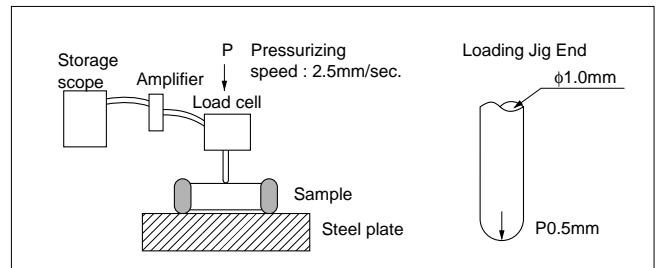

Chip Size	L	W	$\gamma$		
			C0G Characteristics	X7R Characteristics	Y5V Characteristics
<b>GRM21</b>	1.5	1.2	300	180	160
<b>GRM31</b>	2.7	1.5			

(in mm)

#### (5) Results

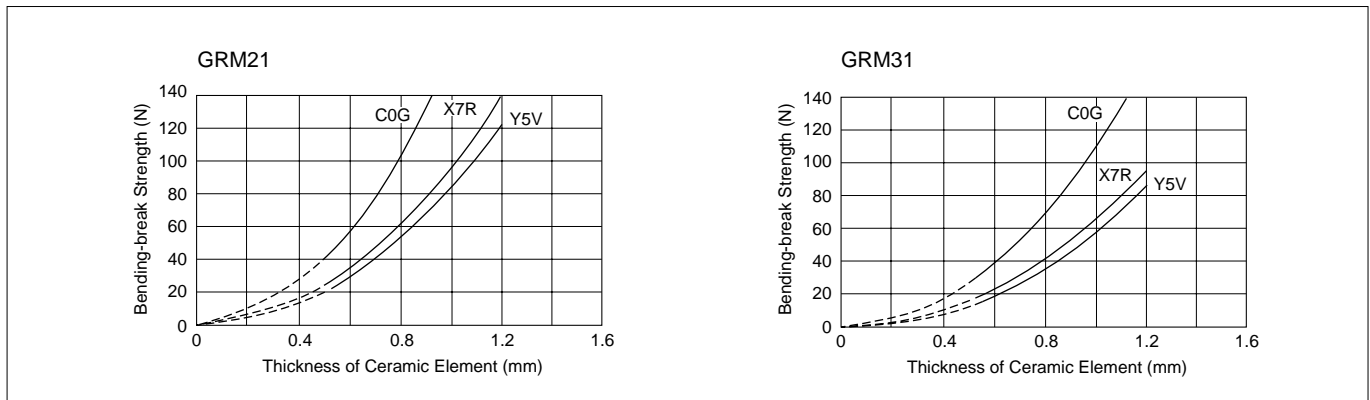

### 6. Thermal Shock

#### (1) Test method

After applying flux (an ethanol solution of 25% rosin), dip the chip in a solder bath (6X4 eutectic solder) in accordance with the following conditions :

#### (2) Test samples

GRM21 C0G/X7R/Y5V Characteristics T=0.6mm typical

#### (3) Acceptance criteria

Visually inspect the test sample with a 60-power optical microscope. Chips exhibiting breaks or cracks shall be determined to be defective.

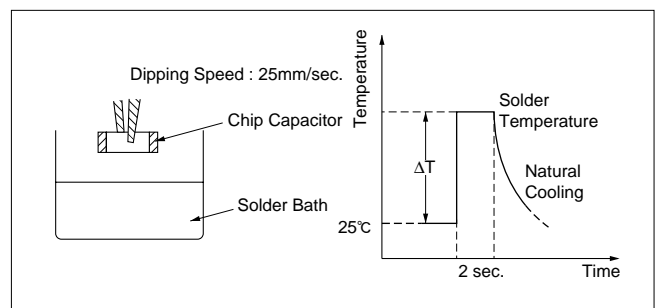

Continued on the following page. ☞

## Reference Data

☐ Continued from the preceding page.

### (4) Results

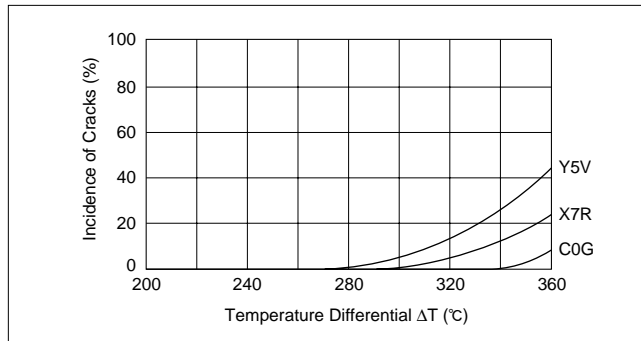

## 7. Solder Heat Resistance

### (1) Test Method

#### ① Reflow soldering :

Apply about 300 μm of solder paste over the alumina substrate. After reflow soldering, remove the chip and check for leaching that may have occurred on the outer electrode.

#### ② Flow soldering :

After dipping the test sample with a pair of tweezers in wave solder (eutectic solder), check for leaching that may have occurred on the outer electrode.

#### ③ Dip soldering :

After dipping the test sample with a pair of tweezers in static solder (eutectic solder), check for leaching that may have occurred on the outer electrode.

#### ④ Flux to be used : An ethanol solution of 25% rosin.

### (2) Test samples

GRM21 : For flow/reflow soldering T=0.6mm

### (3) Acceptance criteria

The starting time of leaching should be defined as the time when the outer electrode has lost 25 % of the total edge length of A-B-C-D as illustrated :

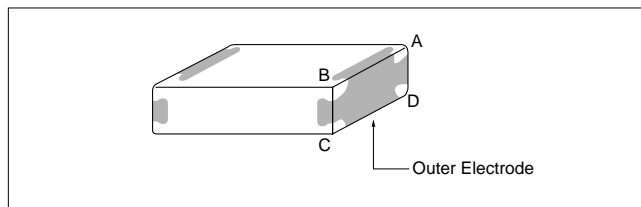

### (4) Results

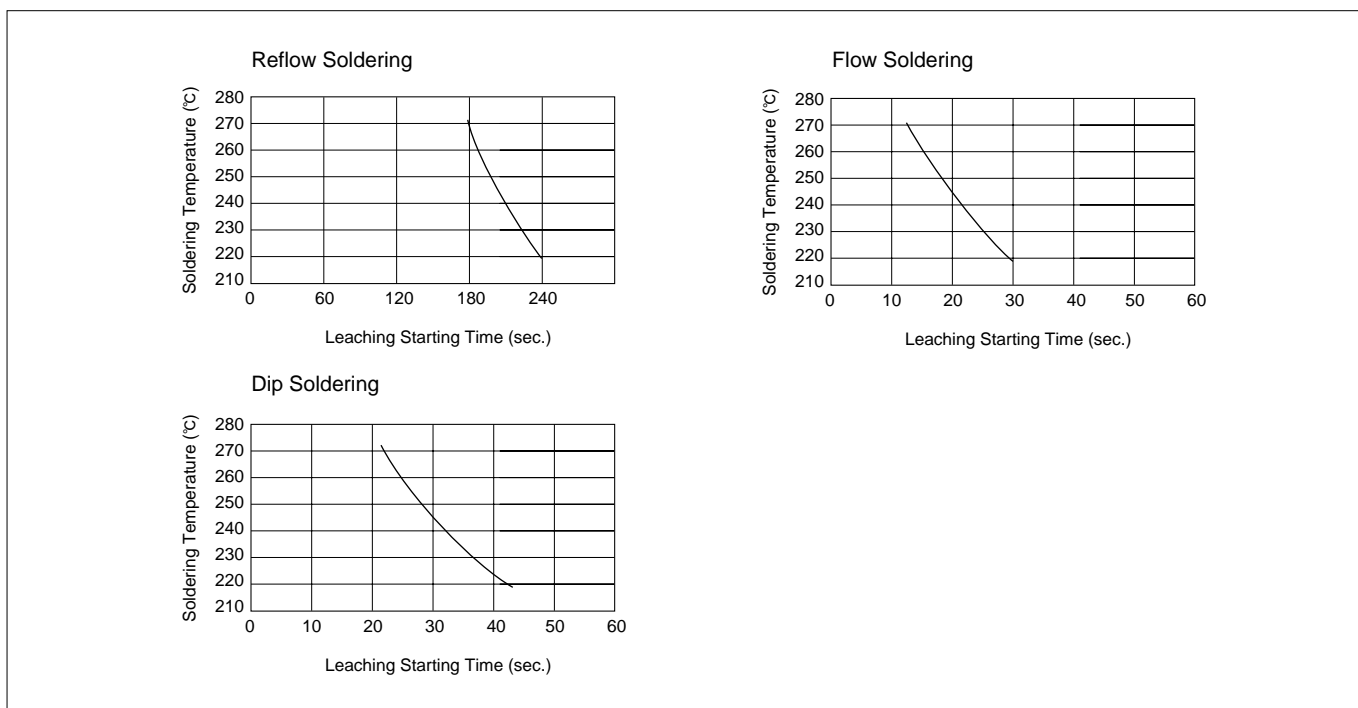

Continued on the following page. ☐



## Reference Data

☐ Continued from the preceding page.

### 8. Thermal Shock when Making Corrections with a Soldering Iron

#### (1) Test Method

Apply a soldering iron meeting the conditions below to the soldered joint of a chip that has been soldered to a paper phenol board, while supplying wire solder. (Note: the soldering iron tip should not directly touch the ceramic element of the chip.)

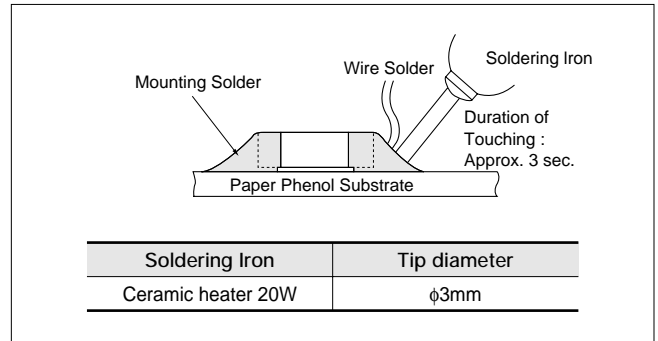

#### (2) Test Samples

GRM21 C0G/X7R/Y5V Characteristics T=0.6mm

#### (3) Acceptance Criteria for Defects

Observe the appearance of the test sample with a 60-power optical microscope. Those units displaying any breaks or cracks are determined to be defective.

#### (4) Results

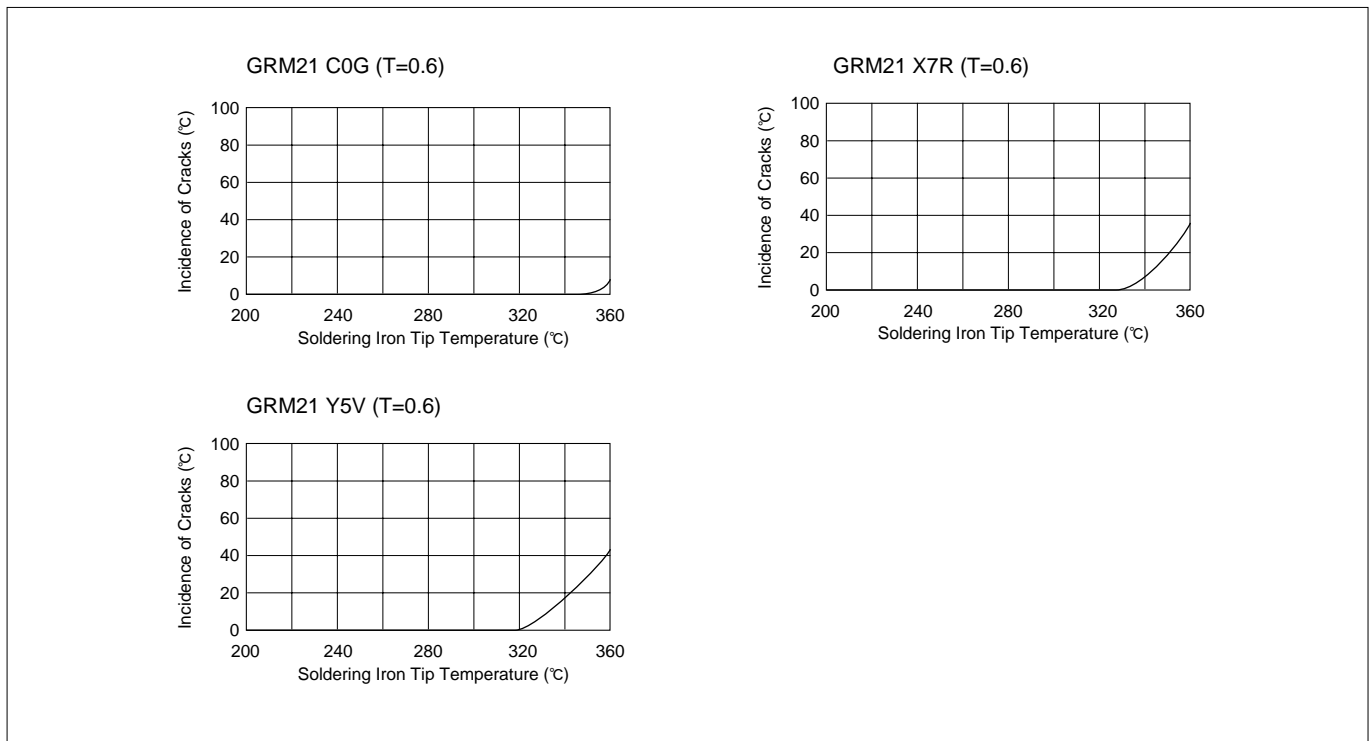

# Chip Monolithic Ceramic Capacitors



## Medium-voltage Low Dissipation Factor

### ■ Features

1. Murata's original internal electrode structure realizes high flash-over voltage.
2. A new monolithic structure for small, surface-mountable devices capable of operating at high voltage levels.
3. Sn-plated external electrodes realize good solderability.
4. Use the GRM31 type with flow or reflow soldering, and other types with reflow soldering only.
5. Low-loss and suitable for high frequency circuits.
6. The temperature characteristics COG and SL are temperature compensating type, and R is high dielectric constant type.

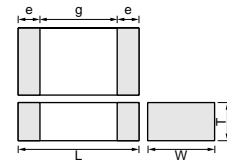

Part Number	Dimensions (mm)								
	L	W	T	e min.	g min.				
GRM31A	3.2 ±0.2	1.6 ±0.2	1.0 +0.0, -0.3	0.3	1.5*				
GRM31B			1.25 +0.0, -0.3		1.8				
GRM32Q	3.2 ±0.2	2.5 ±0.2	1.5 +0.0, -0.3		0.3	2.9			
GRM42A			1.0 +0.0, -0.3						
GRM42B	4.5 ±0.3	2.0 ±0.2	1.25 +0.0, -0.3				0.3	2.9	
GRM42D			2.0 ±0.3						
GRM43D	4.5 ±0.3	3.2 ±0.3	2.0 +0.0, -0.3	0.3					2.9
GRM43E			2.5 +0.0, -0.3						

\* GRM31B1X3D : 1.8mm min.

### ■ Applications

1. Ideal for use on high frequency pulse circuits such as snubber circuits for switching power supplies, DC/DC converters, ballasts (inverter fluorescent lamps), etc.
2. Ideal for use as the ballast in liquid crystal back lighting inverters.
3. Please contact our sales representatives or engineers before using our products for other applications not specified above.

Part Number	Rated Voltage (V)	TC Code (Standard)	Capacitance (pF)	Length L (mm)	Width W (mm)	Thickness T (mm)	Electrode g min. (mm)	Electrode e (mm)
GRM31AR32J101KY01D	DC630	R (JIS)	100 ±10%	3.2	1.6	1.0	1.5	0.3 min.
GRM31AR32J151KY01D	DC630	R (JIS)	150 ±10%	3.2	1.6	1.0	1.5	0.3 min.
GRM31AR32J221KY01D	DC630	R (JIS)	220 ±10%	3.2	1.6	1.0	1.5	0.3 min.
GRM31AR32J331KY01D	DC630	R (JIS)	330 ±10%	3.2	1.6	1.0	1.5	0.3 min.
GRM31BR32J471KY01L	DC630	R (JIS)	470 ±10%	3.2	1.6	1.25	1.5	0.3 min.
GRM31BR32J681KY01L	DC630	R (JIS)	680 ±10%	3.2	1.6	1.25	1.5	0.3 min.
GRM31BR32J102KY01L	DC630	R (JIS)	1000 ±10%	3.2	1.6	1.25	1.5	0.3 min.
GRM31AR33A470KY01D	DC1000	R (JIS)	47 ±10%	3.2	1.6	1.0	1.5	0.3 min.
GRM31AR33A680KY01D	DC1000	R (JIS)	68 ±10%	3.2	1.6	1.0	1.5	0.3 min.
GRM31AR33A101KY01D	DC1000	R (JIS)	100 ±10%	3.2	1.6	1.0	1.5	0.3 min.
GRM31AR33A151KY01D	DC1000	R (JIS)	150 ±10%	3.2	1.6	1.0	1.5	0.3 min.
GRM31AR33A221KY01D	DC1000	R (JIS)	220 ±10%	3.2	1.6	1.0	1.5	0.3 min.
GRM31AR33A331KY01D	DC1000	R (JIS)	330 ±10%	3.2	1.6	1.0	1.5	0.3 min.
GRM31BR33A471KY01L	DC1000	R (JIS)	470 ±10%	3.2	1.6	1.25	1.5	0.3 min.
GRM31B1X3D100JY01L	DC2000	SL (JIS)	10 ±5%	3.2	1.6	1.25	1.8	0.3 min.
GRM31B1X3D120JY01L	DC2000	SL (JIS)	12 ±5%	3.2	1.6	1.25	1.8	0.3 min.
GRM31B1X3D150JY01L	DC2000	SL (JIS)	15 ±5%	3.2	1.6	1.25	1.8	0.3 min.
GRM31B1X3D180JY01L	DC2000	SL (JIS)	18 ±5%	3.2	1.6	1.25	1.8	0.3 min.
GRM31B1X3D220JY01L	DC2000	SL (JIS)	22 ±5%	3.2	1.6	1.25	1.8	0.3 min.
GRM32Q1X3D270JY01L	DC2000	SL (JIS)	27 ±5%	3.2	2.5	1.5	1.8	0.3 min.
GRM32Q1X3D330JY01L	DC2000	SL (JIS)	33 ±5%	3.2	2.5	1.5	1.8	0.3 min.
GRM32Q1X3D390JY01L	DC2000	SL (JIS)	39 ±5%	3.2	2.5	1.5	1.8	0.3 min.
GRM32Q1X3D470JY01L	DC2000	SL (JIS)	47 ±5%	3.2	2.5	1.5	1.8	0.3 min.
GRM32Q1X3D560JY01L	DC2000	SL (JIS)	56 ±5%	3.2	2.5	1.5	1.8	0.3 min.

Continued on the following page.

Continued from the preceding page.

Part Number	Rated Voltage (V)	TC Code (Standard)	Capacitance (pF)	Length L (mm)	Width W (mm)	Thickness T (mm)	Electrode g min. (mm)	Electrode e (mm)
<b>GRM32Q1X3D680JY01L</b>	DC2000	SL (JIS)	68 ±5%	3.2	2.5	1.5	1.8	0.3 min.
<b>GRM32Q1X3D820JY01L</b>	DC2000	SL (JIS)	82 ±5%	3.2	2.5	1.5	1.8	0.3 min.
<b>GRM43D1X3D121JY01L</b>	DC2000	SL (JIS)	120 ±5%	4.5	3.2	2.0	2.9	0.3 min.
<b>GRM43D1X3D151JY01L</b>	DC2000	SL (JIS)	150 ±5%	4.5	3.2	2.0	2.9	0.3 min.
<b>GRM43D1X3D181JY01L</b>	DC2000	SL (JIS)	180 ±5%	4.5	3.2	2.0	2.9	0.3 min.
<b>GRM43D1X3D221JY01L</b>	DC2000	SL (JIS)	220 ±5%	4.5	3.2	2.0	2.9	0.3 min.
<b>GRM42A5C3F100JW01L</b>	DC3150	C0G (EIA)	10 ±5%	4.5	2.0	1.0	2.9	0.3 min.
<b>GRM42A5C3F120JW01L</b>	DC3150	C0G (EIA)	12 ±5%	4.5	2.0	1.0	2.9	0.3 min.
<b>GRM42A5C3F150JW01L</b>	DC3150	C0G (EIA)	15 ±5%	4.5	2.0	1.0	2.9	0.3 min.
<b>GRM42A5C3F180JW01L</b>	DC3150	C0G (EIA)	18 ±5%	4.5	2.0	1.0	2.9	0.3 min.
<b>GRM42A5C3F220JW01L</b>	DC3150	C0G (EIA)	22 ±5%	4.5	2.0	1.0	2.9	0.3 min.
<b>GRM42D1X3F560JY02L</b>	DC3150	SL (JIS)	56 ±5%	4.5	2.0	2.0	2.9	0.3 min.
<b>GRM42D1X3F680JY02L</b>	DC3150	SL (JIS)	68 ±5%	4.5	2.0	2.0	2.9	0.3 min.
<b>GRM42D1X3F820JY02L</b>	DC3150	SL (JIS)	82 ±5%	4.5	2.0	2.0	2.9	0.3 min.
<b>GRM43E1X3F101JY01L</b>	DC3150	SL (JIS)	100 ±5%	4.5	3.2	2.5	2.9	0.3 min.

Please contact us for SL characteristics information.

DC3150V items are considered to use for the application which is not LCD back lighting inverters circuit.

## Specifications and Test Methods

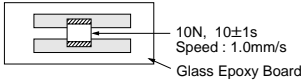
No.	Item	Specifications		Test Method												
		Temperature Compensating Type (C0G, SL Char.)	High Dielectric Constant Type (R Char.)													
1	Operating Temperature Range	-55 to +125°C														
2	Appearance	No defects or abnormalities		Visual inspection												
3	Dimensions	Within the specified dimension		Using calipers												
4	Dielectric Strength	No defects or abnormalities		No failure should be observed when voltage in Table is applied between the terminations for 1 to 5 sec., provided the charge/discharge current is less than 50mA. <table border="1"> <thead> <tr> <th>Rated voltage</th> <th>Test voltage</th> </tr> </thead> <tbody> <tr> <td>DC630V</td> <td>150% of the rated voltage</td> </tr> <tr> <td>DC1kV, DC2kV</td> <td>120% of the rated voltage</td> </tr> <tr> <td>DC3.15kV</td> <td>DC4095V</td> </tr> </tbody> </table>	Rated voltage	Test voltage	DC630V	150% of the rated voltage	DC1kV, DC2kV	120% of the rated voltage	DC3.15kV	DC4095V				
Rated voltage	Test voltage															
DC630V	150% of the rated voltage															
DC1kV, DC2kV	120% of the rated voltage															
DC3.15kV	DC4095V															
5	Insulation Resistance (I.R.)	More than 10,000MΩ		The insulation resistance should be measured with DC500±50V and within 60±5 sec. of charging.												
6	Capacitance	Within the specified tolerance		The capacitance/Q/D.F. should be measured at 20°C at the frequency and voltage shown as follows.												
7	Q/ Dissipation Factor (D.F.)	C0G char. : Q≥1,000 SL char. : C≥30pF : Q≥1,000 C<30pF : Q≥400+20C*2	D.F.≤0.01	(1) Temperature Compensating Type Frequency : 1±0.2MHz Voltage : AC0.5 to 5V (r.m.s.) (2) High Dielectric Constant Type Frequency : 1±0.2kHz Voltage : AC1±0.2V (r.m.s.) •Pretreatment Perform a heat treatment at 150±90 °C for 60±5 min. and then let sit for 24±2 hrs. at *room condition.												
8	Capacitance Temperature Characteristics	Temp. Coefficient C0G char. : 0±30ppm/°C (Temp. Range : -55 to +125°C) SL char. : +350 to -1,000 ppm/°C (Temp. Range : +20 to +85°C)	Cap. Change Within ±15%	(1) Temperature Compensating Type The temperature coefficient is determined using the capacitance measured in step 3 as a reference. When cycling the temperature sequentially from step 1 through 5 (SL : +20 to +85 °C) the capacitance should be within the specified tolerance for the temperature coefficient. <table border="1"> <thead> <tr> <th>Step</th> <th>Temperature (°C)</th> </tr> </thead> <tbody> <tr> <td>1</td> <td>20±2 (25±2 for C0G char.)</td> </tr> <tr> <td>2</td> <td>Min. Operating Temp.±3</td> </tr> <tr> <td>3</td> <td>20±2 (25±2 for C0G char.)</td> </tr> <tr> <td>4</td> <td>Max. Operating Temp.±2</td> </tr> <tr> <td>5</td> <td>20±2 (25±2 for C0G char.)</td> </tr> </tbody> </table> (2) High Dielectric Constant Type The range of capacitance change compared to the 20°C value within -55 to +125°C should be within the specified range. •Pretreatment Perform a heat treatment at 150±90 °C for 60±5 min. and then let sit for 24±2 hrs. at *room condition.	Step	Temperature (°C)	1	20±2 (25±2 for C0G char.)	2	Min. Operating Temp.±3	3	20±2 (25±2 for C0G char.)	4	Max. Operating Temp.±2	5	20±2 (25±2 for C0G char.)
Step	Temperature (°C)															
1	20±2 (25±2 for C0G char.)															
2	Min. Operating Temp.±3															
3	20±2 (25±2 for C0G char.)															
4	Max. Operating Temp.±2															
5	20±2 (25±2 for C0G char.)															
9	Adhesive Strength of Termination	No removal of the terminations or other defect should occur.		Solder the capacitor to the testing jig (glass epoxy board) shown in Fig. 1 using a eutectic solder. Then apply 10N force in the direction of the arrow. The soldering should be done either with an iron or using the reflow method and should be conducted with care so that the soldering is uniform and free of defects such as heat shock. 												

\*1 "Room condition" Temperature : 15 to 35°C, Relative humidity : 45 to 75%, Atmospheric pressure : 86 to 106kPa

\*2 "C" expresses nominal capacitance value (pF).

Continued on the following page. 

## Specifications and Test Methods

Continued from the preceding page.

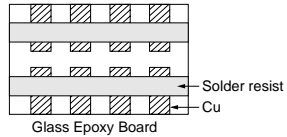
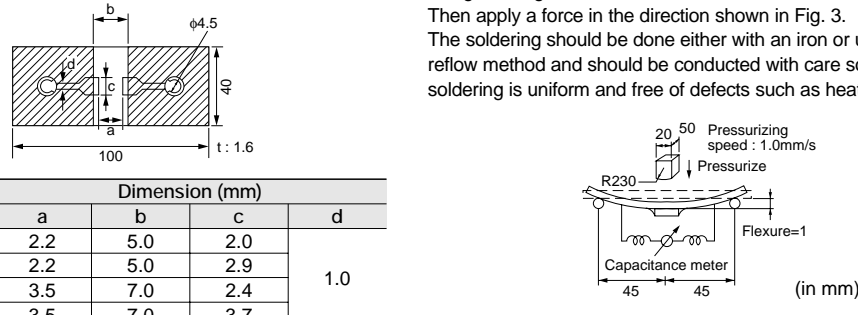
No.	Item	Specifications		Test Method																									
		Temperature Compensating Type (C0G, SL Char.)	High Dielectric Constant Type (R Char.)																										
10	Vibration Resistance	Appearance	No defects or abnormalities		Solder the capacitor to the test jig (glass epoxy board). The capacitor should be subjected to a simple harmonic motion having a total amplitude of 1.5mm, the frequency being varied uniformly between the approximate limits of 10 and 55Hz. The frequency range, from 10 to 55Hz and return to 10Hz, should be traversed in approximately 1 min. This motion should be applied for a period of 2 hrs. in each 3 mutually perpendicular directions (total of 6 hrs.).  																								
		Capacitance	Within the specified tolerance																										
Q/D.F.	C0G char. : $Q \geq 1,000$ SL char. : $C \geq 30\text{pF} : Q \geq 1,000$ $C < 30\text{pF} : Q \geq 400 + 20C^{*2}$	D.F. $\leq 0.01$																											
11	Deflection	No cracking or marking defects should occur.			Solder the capacitor to the testing jig (glass epoxy board) shown in Fig. 2 using a eutectic solder. Then apply a force in the direction shown in Fig. 3. The soldering should be done either with an iron or using the reflow method and should be conducted with care so that the soldering is uniform and free of defects such as heat shock.  																								
		<table border="1" style="margin-left: auto; margin-right: auto;"> <thead> <tr> <th rowspan="2">LxW (mm)</th> <th colspan="4">Dimension (mm)</th> <th rowspan="2"></th> </tr> <tr> <th>a</th> <th>b</th> <th>c</th> <th>d</th> </tr> </thead> <tbody> <tr> <td>3.2x1.6</td> <td>2.2</td> <td>5.0</td> <td>2.0</td> <td rowspan="4" style="text-align: center; vertical-align: middle;">1.0</td> </tr> <tr> <td>3.2x2.5</td> <td>2.2</td> <td>5.0</td> <td>2.9</td> </tr> <tr> <td>4.5x2.0</td> <td>3.5</td> <td>7.0</td> <td>2.4</td> </tr> <tr> <td>4.5x3.2</td> <td>3.5</td> <td>7.0</td> <td>3.7</td> </tr> </tbody> </table> <p style="text-align: center;">Fig. 2</p>	LxW (mm)	Dimension (mm)					a	b	c	d	3.2x1.6	2.2	5.0	2.0	1.0	3.2x2.5	2.2	5.0	2.9	4.5x2.0	3.5	7.0	2.4	4.5x3.2	3.5	7.0	3.7
LxW (mm)	Dimension (mm)																												
	a	b	c	d																									
3.2x1.6	2.2	5.0	2.0	1.0																									
3.2x2.5	2.2	5.0	2.9																										
4.5x2.0	3.5	7.0	2.4																										
4.5x3.2	3.5	7.0	3.7																										
12	Solderability of Termination	75% of the terminations are to be soldered evenly and continuously.			Immerse the capacitor in a solution of ethanol (JIS-K-8101) and rosin (JIS-K-5902) (25% rosin in weight proportion). Immerse in eutectic solder solution for $2 \pm 0.5$ sec. at $235 \pm 5^\circ\text{C}$ . Immersing speed : $25 \pm 2.5\text{mm/s}$																								
13	Resistance to Soldering Heat	Appearance	No marking defects		Preheat the capacitor at $120$ to $150^\circ\text{C}^*$ for 1 min. Immerse the capacitor in eutectic solder solution at $260 \pm 5^\circ\text{C}$ for $10 \pm 1$ sec. Let sit at *room condition for $24 \pm 2$ hrs., then measure. •Immersing speed : $25 \pm 2.5\text{mm/s}$ •Pretreatment for high dielectric constant type Perform a heat treatment at $150 \pm 10^\circ\text{C}$ for $60 \pm 5$ min. and then let sit for $24 \pm 2$ hrs. at *room condition.  *Preheating for more than 3.2x2.5mm <table border="1" style="margin-left: auto; margin-right: auto;"> <thead> <tr> <th>Step</th> <th>Temperature</th> <th>Time</th> </tr> </thead> <tbody> <tr> <td>1</td> <td><math>100^\circ\text{C}</math> to <math>120^\circ\text{C}</math></td> <td>1 min.</td> </tr> <tr> <td>2</td> <td><math>170^\circ\text{C}</math> to <math>200^\circ\text{C}</math></td> <td>1 min.</td> </tr> </tbody> </table>	Step	Temperature	Time	1	$100^\circ\text{C}$ to $120^\circ\text{C}$	1 min.	2	$170^\circ\text{C}$ to $200^\circ\text{C}$	1 min.															
		Step	Temperature	Time																									
		1	$100^\circ\text{C}$ to $120^\circ\text{C}$	1 min.																									
		2	$170^\circ\text{C}$ to $200^\circ\text{C}$	1 min.																									
Capacitance Change	Within $\pm 2.5\%$ or $\pm 0.25\text{pF}$ (Whichever is larger)	Within $\pm 10\%$																											
Q/D.F.	C0G char. : $Q \geq 1,000$ SL char. : $C \geq 30\text{pF} : Q \geq 1,000$ $C < 30\text{pF} : Q \geq 400 + 20C^{*2}$	D.F. $\leq 0.01$																											
I.R.	More than 10,000MΩ																												
Dielectric Strength	In accordance with item No.4																												

\*1 "Room condition" Temperature : 15 to 35°C, Relative humidity : 45 to 75%, Atmospheric pressure : 86 to 106kPa

\*2 "C" expresses nominal capacitance value (pF).

Continued on the following page. ↗

## Specifications and Test Methods

Continued from the preceding page.

No.	Item	Specifications		Test Method																
		Temperature Compensating Type (C0G, SL Char.)	High Dielectric Constant Type (R Char.)																	
14	Temperature Cycle	Appearance	No marking defects		Fix the capacitor to the supporting jig (glass epoxy board) shown in Fig. 4 using a eutectic solder. Perform the 5 cycles according to the 4 heat treatments listed in the following table. Let sit for 24±2 hrs. at *room condition, then measure. <table border="1" style="margin: 10px auto;"> <thead> <tr> <th>Step</th> <th>Temperature (°C)</th> <th>Time (min.)</th> </tr> </thead> <tbody> <tr> <td>1</td> <td>Min. Operating Temp.±3</td> <td>30±3</td> </tr> <tr> <td>2</td> <td>Room Temp.</td> <td>2 to 3</td> </tr> <tr> <td>3</td> <td>Max. Operating Temp.±2</td> <td>30±3</td> </tr> <tr> <td>4</td> <td>Room Temp.</td> <td>2 to 3</td> </tr> </tbody> </table>	Step	Temperature (°C)	Time (min.)	1	Min. Operating Temp.±3	30±3	2	Room Temp.	2 to 3	3	Max. Operating Temp.±2	30±3	4	Room Temp.	2 to 3
		Step	Temperature (°C)	Time (min.)																
		1	Min. Operating Temp.±3	30±3																
		2	Room Temp.	2 to 3																
		3	Max. Operating Temp.±2	30±3																
4	Room Temp.	2 to 3																		
Capacitance Change	Within ±2.5% or ±0.25pF (Whichever is larger)	Within ±10%																		
Q/D.F.	C0G char. : Q≥1,000 SL char. : C≥30pF : Q≥1,000 C<30pF : Q≥400+20C*2	D.F.≤0.01																		
I.R.	More than 10,000MΩ																			
	Dielectric Strength	In accordance with item No.4																		
15	Humidity (Steady State)	Appearance	No marking defects		Let the capacitor sit at 40±2°C and relative humidity of 90 to 95% for 500±2 hrs. Remove and let sit for 24±2 hrs. at *room condition, then measure. •Pretreatment for high dielectric constant type Perform a heat treatment at 150±1.8°C for 60±5 min. and then let sit for 24±2 hrs. at *room condition.															
		Capacitance Change	Within ±5.0% or ±0.5pF (Whichever is larger)	Within ±10%																
		Q/D.F.	C0G char. : Q≥350 SL char. : C≥30pF : Q≥350 C<30pF : Q≥275+ $\frac{C}{2}$ C*2	D.F.≤0.01																
		I.R.	More than 1,000MΩ																	
		Dielectric Strength	In accordance with item No.4																	
16	Life	Appearance	No marking defects		Apply the voltage in following table for 1,000±4 hrs. at maximum operating temperature ±3°C. Remove and let sit for 24±2 hrs. at *room condition, then measure. The charge/discharge current is less than 50mA. •Pretreatment for high dielectric constant type Apply test voltage for 60±5 min. at test temperature. Remove and let sit for 24±2 hrs. at *room condition. <table border="1" style="margin: 10px auto;"> <thead> <tr> <th>Rated voltage</th> <th>Test voltage</th> </tr> </thead> <tbody> <tr> <td>More than DC1kV</td> <td>Rated voltage</td> </tr> <tr> <td>Less than DC1kV</td> <td>120% of the rated voltage</td> </tr> </tbody> </table>	Rated voltage	Test voltage	More than DC1kV	Rated voltage	Less than DC1kV	120% of the rated voltage									
		Rated voltage	Test voltage																	
		More than DC1kV	Rated voltage																	
		Less than DC1kV	120% of the rated voltage																	
		Capacitance Change	Within ±3.0% or ±0.3pF (Whichever is larger)	Within ±10%																
Q/D.F.	C0G char. : Q≥350 SL char. : C≥30pF : Q≥350 C<30pF : Q≥275+ $\frac{C}{2}$ C*2	D.F.≤0.02																		
I.R.	More than 1,000MΩ																			
Dielectric Strength	In accordance with item No.4																			

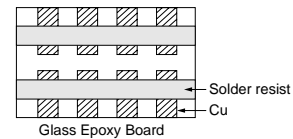

Fig. 4

\*1 "Room condition" Temperature : 15 to 35°C, Relative humidity : 45 to 75%, Atmospheric pressure : 86 to 106kPa  
\*2 "C" expresses nominal capacitance value (pF).

# Chip Monolithic Ceramic Capacitors



## Medium-voltage High-Capacitance for General-Use

### ■ Features

1. A new monolithic structure for small, high capacitance capable of operating at high voltage levels.
2. Sn-plated external electrodes realized good solderability.
3. Use the GRM18/21/31 types with flow or reflow soldering, and other types with reflow soldering only.

### ■ Applications

1. Ideal for use as a hot-cold coupling for DC/DC converter.
2. Ideal for use on line filters and ringer detectors for telephones, facsimiles and modems.
3. Ideal for use on diode-snubber circuits for switching power supplies.

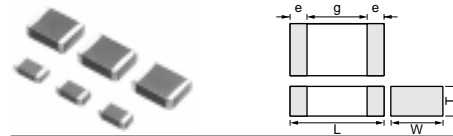

Part Number	Dimensions (mm)				
	L	W	T	e	g min.
GRM188	1.6 ±0.1	0.8 ±0.1	0.8 ±0.1	0.2 to 0.5	0.4
GRM21A	2.0 ±0.2	1.25 ±0.2	1.0 +0, -0.3	0.3 min.	0.7
GRM21B			1.25 ±0.2		
GRM31B	3.2 ±0.2	1.6 ±0.2	1.25 +0, -0.3		
GRM31C			1.6 ±0.2		
GRM32Q	3.2 ±0.3	2.5 ±0.2	1.5 +0, -0.3		
GRM32D			2.0 +0, -0.3		
GRM43Q	4.5 ±0.4	3.2 ±0.3	1.5 +0, -0.3		
GRM43D			2.0 +0, -0.3		
GRM55D	5.7 ±0.4	5.0 ±0.4	2.0 +0, -0.3		2.2
					3.2*

\* GRM55DR73A : 2.5mm min.

Part Number	Rated Voltage (V)	TC Code (Standard)	Capacitance	Length L (mm)	Width W (mm)	Thickness T (mm)	Electrode g min. (mm)	Electrode e (mm)
GRM188R72E221KW07D	DC250	X7R (EIA)	220pF ±10%	1.6	0.8	0.8	0.4	0.2 to 0.5
GRM188R72E331KW07D	DC250	X7R (EIA)	330pF ±10%	1.6	0.8	0.8	0.4	0.2 to 0.5
GRM188R72E471KW07D	DC250	X7R (EIA)	470pF ±10%	1.6	0.8	0.8	0.4	0.2 to 0.5
GRM188R72E681KW07D	DC250	X7R (EIA)	680pF ±10%	1.6	0.8	0.8	0.4	0.2 to 0.5
GRM188R72E102KW07D	DC250	X7R (EIA)	1000pF ±10%	1.6	0.8	0.8	0.4	0.2 to 0.5
GRM21AR72E102KW01D	DC250	X7R (EIA)	1000pF ±10%	2.0	1.25	1.0	0.7	0.3 min.
GRM188R72E152KW07D	DC250	X7R (EIA)	1500pF ±10%	1.6	0.8	0.8	0.4	0.2 to 0.5
GRM21AR72E152KW01D	DC250	X7R (EIA)	1500pF ±10%	2.0	1.25	1.0	0.7	0.3 min.
GRM188R72E222KW07D	DC250	X7R (EIA)	2200pF ±10%	1.6	0.8	0.8	0.4	0.2 to 0.5
GRM21AR72E222KW01D	DC250	X7R (EIA)	2200pF ±10%	2.0	1.25	1.0	0.7	0.3 min.
GRM21AR72E332KW01D	DC250	X7R (EIA)	3300pF ±10%	2.0	1.25	1.0	0.7	0.3 min.
GRM21AR72E472KW01D	DC250	X7R (EIA)	4700pF ±10%	2.0	1.25	1.0	0.7	0.3 min.
GRM21AR72E682KW01D	DC250	X7R (EIA)	6800pF ±10%	2.0	1.25	1.0	0.7	0.3 min.
GRM21BR72E103KW03L	DC250	X7R (EIA)	10000pF ±10%	2.0	1.25	1.25	0.7	0.3 min.
GRM31BR72E153KW01L	DC250	X7R (EIA)	15000pF ±10%	3.2	1.6	1.25	1.2	0.3 min.
GRM31BR72E223KW01L	DC250	X7R (EIA)	22000pF ±10%	3.2	1.6	1.25	1.2	0.3 min.
GRM31CR72E333KW03L	DC250	X7R (EIA)	33000pF ±10%	3.2	1.6	1.6	1.2	0.3 min.
GRM31CR72E473KW03L	DC250	X7R (EIA)	47000pF ±10%	3.2	1.6	1.6	1.2	0.3 min.
GRM32QR72E683KW01L	DC250	X7R (EIA)	68000pF ±10%	3.2	2.5	1.5	1.2	0.3 min.
GRM31CR72E104KW03L	DC250	X7R (EIA)	0.10μF ±10%	3.2	1.6	1.6	1.2	0.3 min.
GRM32DR72E104KW01L	DC250	X7R (EIA)	0.10μF ±10%	3.2	2.5	2.0	1.2	0.3 min.
GRM43QR72E154KW01L	DC250	X7R (EIA)	0.15μF ±10%	4.5	3.2	1.5	2.2	0.3 min.
GRM32DR72E224KW01L	DC250	X7R (EIA)	0.22μF ±10%	3.2	2.5	2.0	1.2	0.3 min.
GRM43DR72E224KW01L	DC250	X7R (EIA)	0.22μF ±10%	4.5	3.2	2.0	2.2	0.3 min.
GRM43DR72E334KW01L	DC250	X7R (EIA)	0.33μF ±10%	4.5	3.2	2.0	2.2	0.3 min.
GRM55DR72E334KW01L	DC250	X7R (EIA)	0.33μF ±10%	5.7	5.0	2.0	3.2	0.3 min.
GRM43DR72E474KW01L	DC250	X7R (EIA)	0.47μF ±10%	4.5	3.2	2.0	2.2	0.3 min.
GRM55DR72E474KW01L	DC250	X7R (EIA)	0.47μF ±10%	5.7	5.0	2.0	3.2	0.3 min.
GRM55DR72E105KW01L	DC250	X7R (EIA)	1.0μF ±10%	5.7	5.0	2.0	3.2	0.3 min.
GRM31BR72J102KW01L	DC630	X7R (EIA)	1000pF ±10%	3.2	1.6	1.25	1.2	0.3 min.
GRM31BR72J152KW01L	DC630	X7R (EIA)	1500pF ±10%	3.2	1.6	1.25	1.2	0.3 min.
GRM31BR72J222KW01L	DC630	X7R (EIA)	2200pF ±10%	3.2	1.6	1.25	1.2	0.3 min.

Continued on the following page.

Continued from the preceding page.

Part Number	Rated Voltage (V)	TC Code (Standard)	Capacitance	Length L (mm)	Width W (mm)	Thickness T (mm)	Electrode g min. (mm)	Electrode e (mm)
GRM31BR72J332KW01L	DC630	X7R (EIA)	3300pF ±10%	3.2	1.6	1.25	1.2	0.3 min.
GRM31BR72J472KW01L	DC630	X7R (EIA)	4700pF ±10%	3.2	1.6	1.25	1.2	0.3 min.
GRM31BR72J682KW01L	DC630	X7R (EIA)	6800pF ±10%	3.2	1.6	1.25	1.2	0.3 min.
GRM31BR72J103KW01L	DC630	X7R (EIA)	10000pF ±10%	3.2	1.6	1.25	1.2	0.3 min.
GRM31CR72J153KW03L	DC630	X7R (EIA)	15000pF ±10%	3.2	1.6	1.6	1.2	0.3 min.
GRM32QR72J223KW01L	DC630	X7R (EIA)	22000pF ±10%	3.2	2.5	1.5	1.2	0.3 min.
GRM32DR72J333KW01L	DC630	X7R (EIA)	33000pF ±10%	3.2	2.5	2.0	1.2	0.3 min.
GRM32DR72J473KW01L	DC630	X7R (EIA)	47000pF ±10%	3.2	2.5	2.0	1.2	0.3 min.
GRM43QR72J683KW01L	DC630	X7R (EIA)	68000pF ±10%	4.5	3.2	1.5	2.2	0.3 min.
GRM43DR72J104KW01L	DC630	X7R (EIA)	0.10μF ±10%	4.5	3.2	2.0	2.2	0.3 min.
GRM55DR72J154KW01L	DC630	X7R (EIA)	0.15μF ±10%	5.7	5.0	2.0	3.2	0.3 min.
GRM55DR72J224KW01L	DC630	X7R (EIA)	0.22μF ±10%	5.7	5.0	2.0	3.2	0.3 min.
GRM31BR73A102KW01L	DC1000	X7R (EIA)	1000pF ±10%	3.2	1.6	1.25	1.2	0.3 min.
GRM31BR73A152KW01L	DC1000	X7R (EIA)	1500pF ±10%	3.2	1.6	1.25	1.2	0.3 min.
GRM31BR73A222KW01L	DC1000	X7R (EIA)	2200pF ±10%	3.2	1.6	1.25	1.2	0.3 min.
GRM31BR73A332KW01L	DC1000	X7R (EIA)	3300pF ±10%	3.2	1.6	1.25	1.2	0.3 min.
GRM31BR73A472KW01L	DC1000	X7R (EIA)	4700pF ±10%	3.2	1.6	1.25	1.2	0.3 min.
GRM32QR73A682KW01L	DC1000	X7R (EIA)	6800pF ±10%	3.2	2.5	1.5	1.2	0.3 min.
GRM32QR73A103KW01L	DC1000	X7R (EIA)	10000pF ±10%	3.2	2.5	1.5	1.2	0.3 min.
GRM32DR73A153KW01L	DC1000	X7R (EIA)	15000pF ±10%	3.2	2.5	2.0	1.2	0.3 min.
GRM32DR73A223KW01L	DC1000	X7R (EIA)	22000pF ±10%	3.2	2.5	2.0	1.2	0.3 min.
GRM43DR73A333KW01L	DC1000	X7R (EIA)	33000pF ±10%	4.5	3.2	2.0	2.2	0.3 min.
GRM43DR73A473KW01L	DC1000	X7R (EIA)	47000pF ±10%	4.5	3.2	2.0	2.2	0.3 min.
GRM55DR73A104KW01L	DC1000	X7R (EIA)	0.10μF ±10%	5.7	5.0	2.0	2.5	0.3 min.

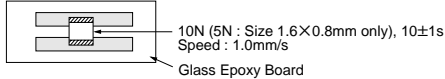
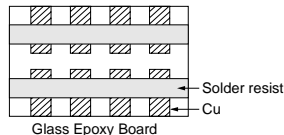
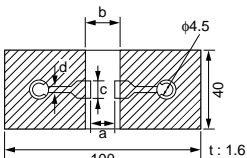
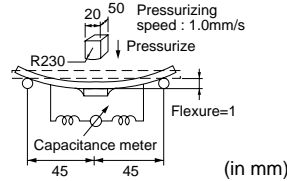

## Specifications and Test Methods

No.	Item	Specifications	Test Method																															
1	Operating Temperature Range	-55 to +125°C	—																															
2	Appearance	No defects or abnormalities	Visual inspection																															
3	Dimensions	Within the specified dimensions	Using calipers																															
4	Dielectric Strength	No defects or abnormalities	No failure should be observed when 150% of the rated voltage (200% of the rated voltage in case of rated voltage : DC250V, 120% of the rated voltage in case of rated voltage : DC1kV) is applied between the terminations for 1 to 5 sec., provided the charge/discharge current is less than 50mA.																															
5	Insulation Resistance (I.R.)	C ≥ 0.01μF : More than 100MΩ • μF C < 0.01μF : More than 10,000MΩ	The insulation resistance should be measured with DC500±50V (DC250±50V in case of rated voltage : DC250V) and within 60±5 sec. of charging.																															
6	Capacitance	Within the specified tolerance	The capacitance/D.F. should be measured at 25°C at a frequency of 1±0.2kHz and a voltage of AC1±0.2V (r.m.s.)																															
7	Dissipation Factor (D.F.)	0.025 max.	•Pretreatment Perform a heat treatment at 150 ± 0.5 °C for 60±5 min. and then let sit for 24±2 hrs. at *room condition.																															
8	Capacitance Temperature Characteristics	Cap. Change Within ±15% (Temp. Range : -55 to +125°C)	The range of capacitance change compared with the 25°C value within -55 to +125°C should be within the specified range. •Pretreatment Perform a heat treatment at 150 ± 0.5 °C for 60±5 min. and then let sit for 24±2 hrs. at *room condition.																															
9	Adhesive Strength of Termination	No removal of the terminations or other defect should occur.	Solder the capacitor to the testing jig (glass epoxy board) shown in Fig. 1 using a eutectic solder. Then apply 10N force in the direction of the arrow. The soldering should be done either with an iron or using the reflow method and should be conducted with care so that the soldering is uniform and free of defects such as heat shock.																															
																																		
		Fig. 1																																
10	Appearance	No defects or abnormalities	Solder the capacitor to the test jig (glass epoxy board). The capacitor should be subjected to a simple harmonic motion having a total amplitude of 1.5mm, the frequency being varied uniformly between the approximate limits of 10 and 55Hz. The frequency range, from 10 to 55Hz and return to 10Hz, should be traversed in approximately 1 min. This motion should be applied for a period of 2 hrs. in each 3 mutually perpendicular directions (total of 6 hrs.).																															
	Capacitance	Within the specified tolerance																																
	D.F.	0.025 max.																																
																																		
		Fig. 2																																
11	Deflection	No cracking or marking defects should occur.	Solder the capacitor to the testing jig (glass epoxy board) shown in Fig. 2 using a eutectic solder. Then apply a force in the direction shown in Fig. 3. The soldering should be done either with an iron or using the reflow method and should be conducted with care so that the soldering is uniform and free of defects such as heat shock.																															
		<div style="text-align: center;">  </div> <table border="1" style="margin: 10px auto; border-collapse: collapse;"> <thead> <tr> <th rowspan="2">LxW (mm)</th> <th colspan="4">Dimension (mm)</th> </tr> <tr> <th>a</th> <th>b</th> <th>c</th> <th>d</th> </tr> </thead> <tbody> <tr> <td>1.6x0.8</td> <td>1.0</td> <td>3.0</td> <td>1.2</td> <td rowspan="6" style="text-align: center; vertical-align: middle;">1.0</td> </tr> <tr> <td>2.0x1.25</td> <td>1.2</td> <td>4.0</td> <td>1.65</td> </tr> <tr> <td>3.2x1.6</td> <td>2.2</td> <td>5.0</td> <td>2.0</td> </tr> <tr> <td>3.2x2.5</td> <td>2.2</td> <td>5.0</td> <td>2.9</td> </tr> <tr> <td>4.5x3.2</td> <td>3.5</td> <td>7.0</td> <td>3.7</td> </tr> <tr> <td>5.7x5.0</td> <td>4.5</td> <td>8.0</td> <td>5.6</td> </tr> </tbody> </table>		LxW (mm)	Dimension (mm)				a	b	c	d	1.6x0.8	1.0	3.0	1.2	1.0	2.0x1.25	1.2	4.0	1.65	3.2x1.6	2.2	5.0	2.0	3.2x2.5	2.2	5.0	2.9	4.5x3.2	3.5	7.0	3.7	5.7x5.0
LxW (mm)	Dimension (mm)																																	
	a	b	c	d																														
1.6x0.8	1.0	3.0	1.2	1.0																														
2.0x1.25	1.2	4.0	1.65																															
3.2x1.6	2.2	5.0	2.0																															
3.2x2.5	2.2	5.0	2.9																															
4.5x3.2	3.5	7.0	3.7																															
5.7x5.0	4.5	8.0	5.6																															
		Fig. 2																																
																																		
		Fig. 3																																

\* "Room condition" Temperature : 15 to 35°C, Relative humidity : 45 to 75%, Atmospheric pressure : 86 to 106kPa

## Specifications and Test Methods

Continued from the preceding page.

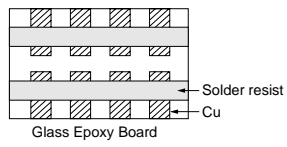
No.	Item	Specifications	Test Method															
12	Solderability of Termination	75% of the terminations are to be soldered evenly and continuously.	Immerse the capacitor in a solution of ethanol (JIS-K-8101) and rosin (JIS-K-5902) (25% rosin in weight proportion). Immerse in eutectic solder solution for 2±0.5 sec. at 235±5°C. Immersing speed : 25±2.5mm/s															
13	Resistance to Soldering Heat	Appearance	No marking defects															
		Capacitance Change	Within ±10%															
		D.F.	0.025 max.															
		I.R.	C≥0.01μF : More than 100MΩ • μF C<0.01μF : More than 10,000MΩ															
		Dielectric Strength	In accordance with item No.4															
			Preheat the capacitor at 120 to 150°C* for 1 min. Immerse the capacitor in eutectic solder solution at 260±5°C for 10±1 sec. Let sit at *room condition for 24±2 hrs., then measure. •Immersing speed : 25±2.5mm/s •Pretreatment Perform a heat treatment at 150 ± 1,8 °C for 60±5 min. and then let sit for 24±2 hrs. at *room condition.  *Preheating for more than 3.2X2.5mm															
			<table border="1"> <thead> <tr> <th>Step</th> <th>Temperature</th> <th>Time</th> </tr> </thead> <tbody> <tr> <td>1</td> <td>100°C to 120°C</td> <td>1 min.</td> </tr> <tr> <td>2</td> <td>170°C to 200°C</td> <td>1 min.</td> </tr> </tbody> </table>	Step	Temperature	Time	1	100°C to 120°C	1 min.	2	170°C to 200°C	1 min.						
Step	Temperature	Time																
1	100°C to 120°C	1 min.																
2	170°C to 200°C	1 min.																
14	Temperature Cycle	Appearance	No marking defects															
		Capacitance Change	Within ±7.5%															
		D.F.	0.025 max.															
		I.R.	C≥0.01μF : More than 100MΩ • μF C<0.01μF : More than 10,000MΩ															
		Dielectric Strength	In accordance with item No.4															
			Fix the capacitor to the supporting jig (glass epoxy board) shown in Fig. 4 using a eutectic solder. Perform the 5 cycles according to the 4 heat treatments listed in the following table. Let sit for 24±2 hrs. at *room condition, then measure.															
			<table border="1"> <thead> <tr> <th>Step</th> <th>Temperature (°C)</th> <th>Time (min.)</th> </tr> </thead> <tbody> <tr> <td>1</td> <td>Min. Operating Temp.±3</td> <td>30±3</td> </tr> <tr> <td>2</td> <td>Room Temp.</td> <td>2 to 3</td> </tr> <tr> <td>3</td> <td>Max. Operating Temp.±2</td> <td>30±3</td> </tr> <tr> <td>4</td> <td>Room Temp.</td> <td>2 to 3</td> </tr> </tbody> </table>	Step	Temperature (°C)	Time (min.)	1	Min. Operating Temp.±3	30±3	2	Room Temp.	2 to 3	3	Max. Operating Temp.±2	30±3	4	Room Temp.	2 to 3
Step	Temperature (°C)	Time (min.)																
1	Min. Operating Temp.±3	30±3																
2	Room Temp.	2 to 3																
3	Max. Operating Temp.±2	30±3																
4	Room Temp.	2 to 3																
			•Pretreatment Perform a heat treatment at 150 ± 1,8 °C for 60±5 min. and then let sit for 24±2 hrs. at *room condition.															
			 <p style="text-align: center;">Fig. 4</p>															
15	Humidity (Steady State)	Appearance	No marking defects															
		Capacitance Change	Within ±15%															
		D.F.	0.05 max.															
		I.R.	C≥0.01μF : More than 10MΩ • μF C<0.01μF : More than 1,000MΩ															
		Dielectric Strength	In accordance with item No.4															
			Let the capacitor sit at 40±2°C and relative humidity of 90 to 95% for 500 ± 2,4 hrs. Remove and let sit for 24±2 hrs. at *room condition, then measure. •Pretreatment Perform a heat treatment at 150 ± 1,8 °C for 60±5 min. and then let sit for 24±2 hrs. at *room condition.															
16	Life	Appearance	No marking defects															
		Capacitance Change	Within ±15% (rated voltage : DC250V, DC630V) Within ±20% (rated voltage : DC1kV)															
		D.F.	0.05 max.															
		I.R.	C≥0.01μF : More than 10MΩ • μF C<0.01μF : More than 1,000MΩ															
		Dielectric Strength	In accordance with item No.4															
			Apply 120% of the rated voltage (150% of the rated voltage in case of rated voltage : DC250V, 110% of the rated voltage in case of rated voltage : DC1kV) for 1,000 ± 4,8 hrs. at maximum operating temperature ±3°C. Remove and let sit for 24 ± 2 hrs. at *room condition, then measure. The charge/discharge current is less than 50mA. •Pretreatment Apply test voltage for 60±5 min. at test temperature. Remove and let sit for 24±2 hrs. at *room condition.															
17	Humidity Loading (Application : DC250V, DC630V item)	Appearance	No marking defects															
		Capacitance Change	Within ±15%															
		D.F.	0.05 max.															
		I.R.	C≥0.01μF : More than 10MΩ • μF C<0.01μF : More than 1,000MΩ															
		Dielectric Strength	In accordance with item No.4															
			Apply the rated voltage at 40±2°C and relative humidity of 90 to 95% for 500 ± 2,4 hrs. Remove and let sit for 24±2 hrs. at *room condition, then measure. •Pretreatment Apply test voltage for 60±5 min. at test temperature. Remove and let sit for 24±2 hrs. at *room condition.															

\* "Room condition" Temperature : 15 to 35°C, Relative humidity : 45 to 75%, Atmospheric pressure : 86 to 106kPa

# Chip Monolithic Ceramic Capacitors



## Only for Information Devices/Tip & Ring

### ■ Features

1. These items are designed specifically for telecommunication devices (IEEE802.3) in Ethernet LAN.
2. A new monolithic structure for small, high capacitance capable of operating at high voltage levels.
3. Sn-plated external electrodes realizes good solderability.
4. Only for reflow soldering.
5. The low-profile type (thickness: 1.5mm max.) is available. Fit for use on thinner type equipment.

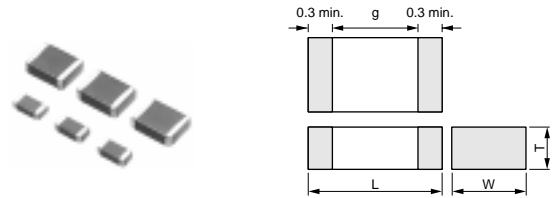

Part Number	Dimensions (mm)			
	L	W	T	g min.
GR442Q	4.5 ±0.3	2.0 ±0.2	1.5 +0, -0.3	2.5
GR443D	4.5 ±0.4	3.2 ±0.3	2.0 +0, -0.3	2.2*
GR443Q			1.5 +0, -0.3	2.5

\* GR443DR73D : 2.5mm min.

### ■ Applications

Ideal for use on telecommunication devices in Ethernet LAN.

Part Number	Rated Voltage (V)	TC Code (Standard)	Capacitance (pF)	Length L (mm)	Width W (mm)	Thickness T (mm)	Electrode g min. (mm)	Electrode e (mm)
GR442QR73D101KW01L	DC2000	X7R (EIA)	100 ±10%	4.5	2.0	1.5	2.5	0.3 min.
GR442QR73D121KW01L	DC2000	X7R (EIA)	120 ±10%	4.5	2.0	1.5	2.5	0.3 min.
GR442QR73D151KW01L	DC2000	X7R (EIA)	150 ±10%	4.5	2.0	1.5	2.5	0.3 min.
GR442QR73D181KW01L	DC2000	X7R (EIA)	180 ±10%	4.5	2.0	1.5	2.5	0.3 min.
GR442QR73D221KW01L	DC2000	X7R (EIA)	220 ±10%	4.5	2.0	1.5	2.5	0.3 min.
GR442QR73D271KW01L	DC2000	X7R (EIA)	270 ±10%	4.5	2.0	1.5	2.5	0.3 min.
GR442QR73D331KW01L	DC2000	X7R (EIA)	330 ±10%	4.5	2.0	1.5	2.5	0.3 min.
GR442QR73D391KW01L	DC2000	X7R (EIA)	390 ±10%	4.5	2.0	1.5	2.5	0.3 min.
GR442QR73D471KW01L	DC2000	X7R (EIA)	470 ±10%	4.5	2.0	1.5	2.5	0.3 min.
GR442QR73D561KW01L	DC2000	X7R (EIA)	560 ±10%	4.5	2.0	1.5	2.5	0.3 min.
GR442QR73D681KW01L	DC2000	X7R (EIA)	680 ±10%	4.5	2.0	1.5	2.5	0.3 min.
GR442QR73D821KW01L	DC2000	X7R (EIA)	820 ±10%	4.5	2.0	1.5	2.5	0.3 min.
GR442QR73D102KW01L	DC2000	X7R (EIA)	1000 ±10%	4.5	2.0	1.5	2.5	0.3 min.
GR442QR73D122KW01L	DC2000	X7R (EIA)	1200 ±10%	4.5	2.0	1.5	2.5	0.3 min.
GR442QR73D152KW01L	DC2000	X7R (EIA)	1500 ±10%	4.5	2.0	1.5	2.5	0.3 min.
GR443QR73D182KW01L	DC2000	X7R (EIA)	1800 ±10%	4.5	3.2	1.5	2.5	0.3 min.
GR443QR73D222KW01L	DC2000	X7R (EIA)	2200 ±10%	4.5	3.2	1.5	2.5	0.3 min.
GR443QR73D272KW01L	DC2000	X7R (EIA)	2700 ±10%	4.5	3.2	1.5	2.5	0.3 min.
GR443QR73D332KW01L	DC2000	X7R (EIA)	3300 ±10%	4.5	3.2	1.5	2.5	0.3 min.
GR443QR73D392KW01L	DC2000	X7R (EIA)	3900 ±10%	4.5	3.2	1.5	2.5	0.3 min.
GR443DR73D472KW01L	DC2000	X7R (EIA)	4700 ±10%	4.5	3.2	2.0	2.5	0.3 min.

## Specifications and Test Methods

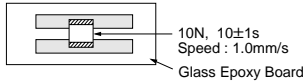
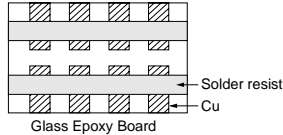
No.	Item	Specifications	Test Method								
1	Operating Temperature Range	-55 to +125°C	-								
2	Appearance	No defects or abnormalities	Visual inspection								
3	Dimensions	Within the specified dimensions	Using calipers								
4	Dielectric Strength	No defects or abnormalities	<p>No failure should be observed when voltage in table is applied between the terminations, provided the charge/discharge current is less than 50mA.</p> <table border="1"> <thead> <tr> <th>Rated voltage</th> <th>Test Voltage</th> <th>Time</th> </tr> </thead> <tbody> <tr> <td rowspan="2">DC2kV</td> <td>120% of the rated voltage</td> <td>60±1 sec.</td> </tr> <tr> <td>AC1500V (r.m.s.)</td> <td>60±1 sec.</td> </tr> </tbody> </table>	Rated voltage	Test Voltage	Time	DC2kV	120% of the rated voltage	60±1 sec.	AC1500V (r.m.s.)	60±1 sec.
Rated voltage	Test Voltage	Time									
DC2kV	120% of the rated voltage	60±1 sec.									
	AC1500V (r.m.s.)	60±1 sec.									
5	Pulse Voltage (Application : DC2kV item)	No self healing break downs or flash-overs have taken place in the capacitor.	<p>10 impulse of alternating polarity is subjected. (5 impulse for each polarity) The interval between impulse is 60 sec. Applied Voltage : 2.5kV zero to peak</p>								
6	Insulation Resistance (I.R.)	More than 6,000MΩ	The insulation resistance should be measured with DC500±50V and within 60±5 sec. of charging.								
7	Capacitance	Within the specified tolerance	The capacitance/D.F. should be measured at 25°C at a frequency of 1±0.2kHz and a voltage of AC1±0.2V (r.m.s.)								
8	Dissipation Factor (D.F.)	0.025 max.	<p>•Pretreatment Perform a heat treatment at 150 ± 0.5 °C for 60±5 min. and then let sit for 24±2 hrs. at *room condition.</p>								
9	Capacitance Temperature Characteristics	Cap. Change within ±15% (Temp. Range : -55 to +125°C)	<p>The range of capacitance change compared with the 25°C value within the specified range. •Pretreatment Perform a heat treatment at 150 ± 0.5 °C for 60±5 min. and then let sit for 24±2 hrs. at *room condition.</p>								
10	Adhesive Strength of Termination	No removal of the terminations or other defect should occur.	<p>Solder the capacitor to the testing jig (glass epoxy board) shown in Fig. 1 using a eutectic solder. Then apply 10N force in the direction of the arrow. The soldering should be done either with an iron or using the reflow method and should be conducted with care so that the soldering is uniform and free of defects such as heat shock.</p>  <p>Fig. 1</p>								
11	Vibration Resistance	Appearance	No defects or abnormalities								
		Capacitance	Within the specified tolerance								
		D.F.	0.025 max.								
			<p>Solder the capacitor to the test jig (glass epoxy board). The capacitor should be subjected to a simple harmonic motion having a total amplitude of 1.5mm, the frequency being varied uniformly between the approximate limits of 10 and 55Hz. The frequency range, from 10 to 55Hz and return to 10Hz, should be traversed in approximately 1 min. This motion should be applied for a period of 2 hrs. in each 3 mutually perpendicular directions (total of 6 hrs.).</p> 								

\* "Room condition" Temperature : 15 to 35°C, Relative humidity : 45 to 75%, Atmospheric pressure : 86 to 106kPa

Continued on the following page. 

## Specifications and Test Methods

Continued from the preceding page.

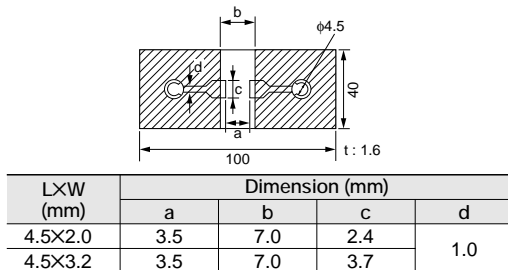
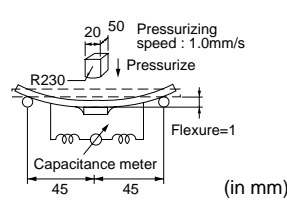
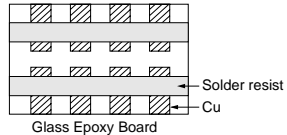
No.	Item	Specifications	Test Method															
12	Deflection	No cracking or marking defects should occur.	Solder the capacitor to the testing jig (glass epoxy board) shown in Fig. 2 using a eutectic solder. Then apply a force in the direction shown in Fig. 3. The soldering should be done either with an iron or using the reflow method and should be conducted with care so that the soldering is uniform and free of defects such as heat shock.															
		 <table border="1" style="margin-left: auto; margin-right: auto;"> <thead> <tr> <th rowspan="2">L×W (mm)</th> <th colspan="4">Dimension (mm)</th> </tr> <tr> <th>a</th> <th>b</th> <th>c</th> <th>d</th> </tr> </thead> <tbody> <tr> <td>4.5×2.0</td> <td>3.5</td> <td>7.0</td> <td>2.4</td> <td rowspan="2">1.0</td> </tr> <tr> <td>4.5×3.2</td> <td>3.5</td> <td>7.0</td> <td>3.7</td> </tr> </tbody> </table> <p style="text-align: center;">Fig. 2</p>		L×W (mm)	Dimension (mm)				a	b	c	d	4.5×2.0	3.5	7.0	2.4	1.0	4.5×3.2
L×W (mm)	Dimension (mm)																	
	a	b	c	d														
4.5×2.0	3.5	7.0	2.4	1.0														
4.5×3.2	3.5	7.0	3.7															
			 <p style="text-align: center;">Fig. 3</p>															
13	Solderability of Termination	75% of the terminations are to be soldered evenly and continuously.	Immerse the capacitor in a solution of ethanol (JIS-K-8101) and rosin (JIS-K-5902) (25% rosin in weight proportion). Immerse in eutectic solder solution for 2±0.5 sec. at 235±5°C. Immersing speed : 25±2.5mm/s															
14	Resistance to Soldering Heat	Appearance	No marking defects															
		Capacitance Change	Within ±10%															
		D.F.	0.025 max.															
		I.R.	More than 1,000MΩ															
		Dielectric Strength	In accordance with item No.4															
			Preheat the capacitor at 120 to 150°C* for 1 min. Immerse the capacitor in eutectic solder solution at 260±5°C for 10±1 sec. Let sit at *room condition for 24±2 hrs., then measure. •Immersing speed : 25±2.5mm/s •Pretreatment Perform a heat treatment at 150 ± 18°C for 60±5 min. and then let sit for 24±2 hrs. at *room condition.  *Preheating for more than 3.2×2.5mm															
			<table border="1" style="margin-left: auto; margin-right: auto;"> <thead> <tr> <th>Step</th> <th>Temperature</th> <th>Time</th> </tr> </thead> <tbody> <tr> <td>1</td> <td>100°C to 120°C</td> <td>1 min.</td> </tr> <tr> <td>2</td> <td>170°C to 200°C</td> <td>1 min.</td> </tr> </tbody> </table>	Step	Temperature	Time	1	100°C to 120°C	1 min.	2	170°C to 200°C	1 min.						
Step	Temperature	Time																
1	100°C to 120°C	1 min.																
2	170°C to 200°C	1 min.																
15	Temperature Cycle	Appearance	No marking defects															
		Capacitance Change	Within ±15%															
		D.F.	0.05 max.															
		I.R.	More than 3,000MΩ															
		Dielectric Strength	In accordance with item No.4															
			Fix the capacitor to the supporting jig (glass epoxy board) shown in Fig. 4 using a eutectic solder. Perform the 5 cycles according to the 4 heat treatments listed in the following table. Let sit for 24±2 hrs. at *room condition, then measure.															
			<table border="1" style="margin-left: auto; margin-right: auto;"> <thead> <tr> <th>Step</th> <th>Temperature (°C)</th> <th>Time (min.)</th> </tr> </thead> <tbody> <tr> <td>1</td> <td>Min. Operating Temp.±3</td> <td>30±3</td> </tr> <tr> <td>2</td> <td>Room Temp.</td> <td>2 to 3</td> </tr> <tr> <td>3</td> <td>Max. Operating Temp.±2</td> <td>30±3</td> </tr> <tr> <td>4</td> <td>Room Temp.</td> <td>2 to 3</td> </tr> </tbody> </table>	Step	Temperature (°C)	Time (min.)	1	Min. Operating Temp.±3	30±3	2	Room Temp.	2 to 3	3	Max. Operating Temp.±2	30±3	4	Room Temp.	2 to 3
Step	Temperature (°C)	Time (min.)																
1	Min. Operating Temp.±3	30±3																
2	Room Temp.	2 to 3																
3	Max. Operating Temp.±2	30±3																
4	Room Temp.	2 to 3																
			•Pretreatment Perform a heat treatment at 150 ± 18°C for 60±5 min. and then let sit for 24±2 hrs. at *room condition.															
			 <p style="text-align: center;">Fig. 4</p>															
16	Humidity (Steady State)	Appearance	No marking defects															
		Capacitance Change	Within ±15%															
		D.F.	0.05 max.															
		I.R.	More than 1,000MΩ															
		Dielectric Strength	In accordance with item No.4															
			Let the capacitor sit at 40±2°C and relative humidity of 90 to 95% for 500 ± 24 hrs. Remove and let sit for 24±2 hrs. at *room condition, then measure. •Pretreatment Perform a heat treatment at 150 ± 18°C for 60±5 min. and then let sit for 24±2 hrs. at *room condition.															

\* "Room condition" Temperature : 15 to 35°C, Relative humidity : 45 to 75%, Atmospheric pressure : 86 to 106kPa

Continued on the following page. ↗

## Specifications and Test Methods

☐ Continued from the preceding page.

No.	Item	Specifications	Test Method
17	Life	Appearance	No marking defects
		Capacitance Change	Within $\pm 20\%$
		D.F.	0.05 max.
		I.R.	More than 2,000M $\Omega$
		Dielectric Strength	In accordance with item No.4
			Apply 110% of the rated voltage for 1,000 $\pm 48$ hrs. at maximum operating temperature $\pm 3^\circ\text{C}$ . Remove and let sit for 24 $\pm 2$ hrs. at *room condition, then measure. The charge/discharge current is less than 50mA. •Pretreatment Apply test voltage for 60 $\pm 5$ min. at test temperature. Remove and let sit for 24 $\pm 2$ hrs. at *room condition.
18	Humidity Loading (Application : DC250V item)	Appearance	No marking defects
		Capacitance Change	Within $\pm 15\%$
		D.F.	0.05 max.
		I.R.	More than 10M $\Omega$ • $\mu\text{F}$
		Dielectric Strength	In accordance with item No.4
			Apply the rated voltage at 40 $\pm 2^\circ\text{C}$ and relative humidity of 90 to 95% for 500 $\pm 24$ hrs. Remove and let sit for 24 $\pm 2$ hrs. at *room condition, then measure. •Pretreatment Apply test voltage for 60 $\pm 5$ min. at test temperature. Remove and let sit for 24 $\pm 2$ hrs. at *room condition.

\* "Room condition" Temperature : 15 to 35 $^\circ\text{C}$ , Relative humidity : 45 to 75%, Atmospheric pressure : 86 to 106kPa

# Chip Monolithic Ceramic Capacitors



## AC250V Type (Which Meet Japanese Law)

### ■ Features

1. Chip monolithic ceramic capacitor for AC lines.
2. A new monolithic structure for small, high capacitance capable of operating at high voltage levels.
3. Sn-plated external electrodes realizes good solderability.
4. Only for reflow soldering.
5. Capacitance 0.01 to 0.1 uF for connecting lines and 470 to 4700 pF for connecting lines to earth.

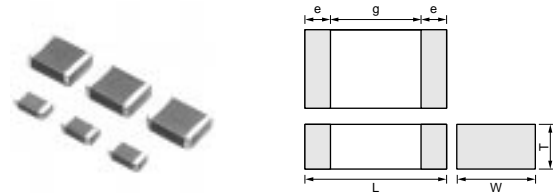

Part Number	Dimensions (mm)				
	L	W	T	e min.	g min.
<b>GA242Q</b>	4.5 ±0.3	2.0 ±0.2	1.5 +0, -0.3	0.3	2.5
<b>GA243D</b>	4.5 ±0.4	3.2 ±0.3	2.0 +0, -0.3		
<b>GA243Q</b>			1.5 +0, -0.3		
<b>GA255D</b>	5.7 ±0.4	5.0 ±0.4	2.0 +0, -0.3		

### ■ Applications

Noise suppression filters for switching power supplies, telephones, facsimiles, modems.

### ■ Reference Standard

GA2 series obtains no safety approval.

This series is based on JIS C 5102, JIS C 5150, and the standards of the electrical appliance and material safety law of Japan (separated table 4).

Part Number	Rated Voltage (V)	TC Code (Standard)	Capacitance	Length L (mm)	Width W (mm)	Thickness T (mm)	Electrode g min. (mm)	Electrode e (mm)
<b>GA242QR7E2471MW01L</b>	AC250 (r.m.s.)	X7R (EIA)	470pF ±20%	4.5	2.0	1.5	2.5	0.3 min.
<b>GA242QR7E2102MW01L</b>	AC250 (r.m.s.)	X7R (EIA)	1000pF ±20%	4.5	2.0	1.5	2.5	0.3 min.
<b>GA243QR7E2222MW01L</b>	AC250 (r.m.s.)	X7R (EIA)	2200pF ±20%	4.5	3.2	1.5	2.5	0.3 min.
<b>GA243QR7E2332MW01L</b>	AC250 (r.m.s.)	X7R (EIA)	3300pF ±20%	4.5	3.2	1.5	2.5	0.3 min.
<b>GA243DR7E2472MW01L</b>	AC250 (r.m.s.)	X7R (EIA)	4700pF ±20%	4.5	3.2	2.0	2.5	0.3 min.
<b>GA243QR7E2103MW01L</b>	AC250 (r.m.s.)	X7R (EIA)	10000pF ±20%	4.5	3.2	1.5	2.5	0.3 min.
<b>GA243QR7E2223MW01L</b>	AC250 (r.m.s.)	X7R (EIA)	22000pF ±20%	4.5	3.2	1.5	2.5	0.3 min.
<b>GA243DR7E2473MW01L</b>	AC250 (r.m.s.)	X7R (EIA)	47000pF ±20%	4.5	3.2	2.0	2.5	0.3 min.
<b>GA255DR7E2104MW01L</b>	AC250 (r.m.s.)	X7R (EIA)	0.10μF ±20%	5.7	5.0	2.0	2.5	0.3 min.

## Specifications and Test Methods

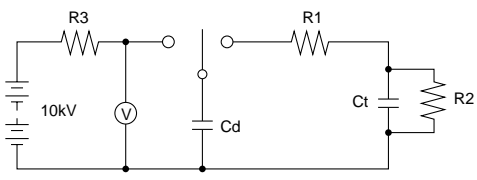
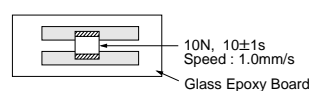
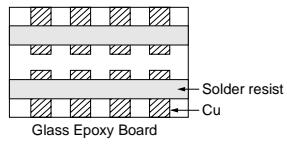
No.	Item	Specifications	Test Method						
1	Operating Temperature Range	-55 to +125°C	—						
2	Appearance	No defects or abnormalities	Visual inspection						
3	Dimensions	Within the specified dimensions	Using calipers						
4	Dielectric Strength	No defects or abnormalities	No failure should be observed when voltage in table is applied between the terminations for 60±1 sec., provided the charge/discharge current is less than 50mA. <table border="1" style="margin-left: auto; margin-right: auto;"> <thead> <tr> <th>Nominal Capacitance</th> <th>Test voltage</th> </tr> </thead> <tbody> <tr> <td>C≥10,000pF</td> <td>AC575V (r.m.s.)</td> </tr> <tr> <td>C&lt;10,000pF</td> <td>AC1500V (r.m.s.)</td> </tr> </tbody> </table>	Nominal Capacitance	Test voltage	C≥10,000pF	AC575V (r.m.s.)	C<10,000pF	AC1500V (r.m.s.)
Nominal Capacitance	Test voltage								
C≥10,000pF	AC575V (r.m.s.)								
C<10,000pF	AC1500V (r.m.s.)								
5	Insulation Resistance (I.R.)	More than 2,000MΩ	The insulation resistance should be measured with DC500±50V and within 60±5 sec. of charging.						
6	Capacitance	Within the specified tolerance	The capacitance/D.F. should be measured at 25°C at a frequency of 1±0.2kHz and a voltage of AC1±0.2V (r.m.s.)						
7	Dissipation Factor (D.F.)	0.025 max.	<ul style="list-style-type: none"> <li>•Pretreatment</li> </ul> Perform a heat treatment at 150±1.8°C for 60±5 min. and then let sit for 24±2 hrs. at *room condition.						
8	Capacitance Temperature Characteristics	Cap. Change Within ±15% (Temp. Range : -55 to +125°C)	The range of capacitance change compared with the 25°C value within -55 to +125°C should be within the specified range. <ul style="list-style-type: none"> <li>•Pretreatment</li> </ul> Perform a heat treatment at 150±1.8°C for 60±5 min. and then let sit for 24±2 hrs. at *room condition.						
9	Discharge Test (Application: Nominal Capacitance C<10,000pF)	Appearance	No defects or abnormalities <p>As in Fig., discharge is made 50 times at 5 sec. intervals from the capacitor (Cd) charged at DC voltage of specified.</p>  <p style="text-align: center;">Ct : Capacitor under test Cd : 0.001μF R1 : 1,000Ω R2 : 100MΩ R3 : Surge resistance</p>						
10	Adhesive Strength of Termination	No removal of the terminations or other defects should occur.	Solder the capacitor to the testing jig (glass epoxy board) shown in Fig. 1 using a eutectic solder. Then apply 10N force in the direction of the arrow. The soldering should be done either with an iron or using the reflow method and should be conducted with care so that the soldering is uniform and free of defects such as heat shock.  <p style="text-align: center;">Fig. 1</p>						
11	Vibration Resistance	Appearance	No defects or abnormalities						
		Capacitance	Within the specified tolerance						
		D.F.	0.025 max.						
			Solder the capacitor to the test jig (glass epoxy board). The capacitor should be subjected to a simple harmonic motion having a total amplitude of 1.5mm, the frequency being varied uniformly between the approximate limits of 10 and 55Hz. The frequency range, from 10 to 55Hz and return to 10Hz, should be traversed in approximately 1 min. This motion should be applied for a period of 2 hrs. in each 3 mutually perpendicular directions (total of 6 hrs.). 						

\* "Room condition" Temperature : 15 to 35°C, Relative humidity : 45 to 75%, Atmospheric pressure : 86 to 106kPa

Continued on the following page.



## Specifications and Test Methods

Continued from the preceding page.

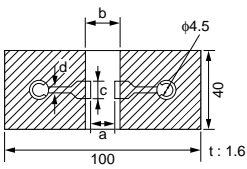
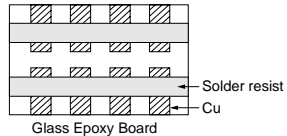
No.	Item	Specifications	Test Method																				
12	Deflection	No cracking or marking defects should occur.	Solder the capacitor to the testing jig (glass epoxy board) shown in Fig. 2 using a eutectic solder. Then apply a force in the direction shown in Fig. 3. The soldering should be done either with an iron or using the reflow method and should be conducted with care so that the soldering is uniform and free of defects such as heat shock.																				
		 <table border="1" style="margin: 10px auto; border-collapse: collapse;"> <thead> <tr> <th rowspan="2">L×W (mm)</th> <th colspan="4">Dimension (mm)</th> </tr> <tr> <th>a</th> <th>b</th> <th>c</th> <th>d</th> </tr> </thead> <tbody> <tr> <td>4.5×2.0</td> <td>3.5</td> <td>7.0</td> <td>2.4</td> <td rowspan="3" style="text-align: center;">1.0</td> </tr> <tr> <td>4.5×3.2</td> <td>3.5</td> <td>7.0</td> <td>3.7</td> </tr> <tr> <td>5.7×5.0</td> <td>4.5</td> <td>8.0</td> <td>5.6</td> </tr> </tbody> </table> <p style="text-align: center;">Fig. 2</p>		L×W (mm)	Dimension (mm)				a	b	c	d	4.5×2.0	3.5	7.0	2.4	1.0	4.5×3.2	3.5	7.0	3.7	5.7×5.0	4.5
L×W (mm)	Dimension (mm)																						
	a	b	c	d																			
4.5×2.0	3.5	7.0	2.4	1.0																			
4.5×3.2	3.5	7.0	3.7																				
5.7×5.0	4.5	8.0	5.6																				
13	Solderability of Termination	75% of the terminations are to be soldered evenly and continuously.	Immerse the capacitor in a solution of ethanol (JIS-K-8101) and rosin (JIS-K-5902) (25% rosin in weight proportion). Immerse in eutectic solder solution for 2±0.5 sec. at 235±5°C. Immersing speed : 25±2.5mm/s																				
14	Humidity Insulation	Appearance	No marking defects	The capacitor should be subjected to 40±2°C, relative humidity of 90 to 98% for 8 hrs., and then removed in *room condition for 16 hrs. until 5 cycles.																			
		Capacitance Change	Within ±15%																				
		D.F.	0.05 max.																				
		I.R.	More than 1,000MΩ																				
		Dielectric Strength	In accordance with item No.4																				
15	Resistance to Soldering Heat	Appearance	No marking defects	Preheat the capacitor as table. Immerse the capacitor in eutectic solder solution at 260±5°C for 10±1 sec. Let sit at *room condition for 24±2 hrs., then measure. •Immersing speed : 25±2.5mm/s •Pretreatment Perform a heat treatment at 150 ± 18°C for 60±5 min. and then let sit for 24±2 hrs. at *room condition. *Preheating																			
		Capacitance Change	Within ±10%																				
		D.F.	0.025 max.																				
		I.R.	More than 2,000MΩ																				
		Dielectric Strength	In accordance with item No.4																				
			<table border="1" style="border-collapse: collapse; width: 100%;"> <thead> <tr> <th>Step</th> <th>Temperature</th> <th>Time</th> </tr> </thead> <tbody> <tr> <td style="text-align: center;">1</td> <td style="text-align: center;">100°C to 120°C</td> <td style="text-align: center;">1 min.</td> </tr> <tr> <td style="text-align: center;">2</td> <td style="text-align: center;">170°C to 200°C</td> <td style="text-align: center;">1 min.</td> </tr> </tbody> </table>	Step	Temperature	Time	1	100°C to 120°C	1 min.	2	170°C to 200°C	1 min.											
Step	Temperature	Time																					
1	100°C to 120°C	1 min.																					
2	170°C to 200°C	1 min.																					
16	Temperature Cycle	Appearance	No marking defects	Fix the capacitor to the supporting jig (glass epoxy board) shown in Fig. 4 using a eutectic solder. Perform the 5 cycles according to the 4 heat treatments listed in the following table. Let sit for 24±2 hrs. at *room condition, then measure.																			
		Capacitance Change	Within ±15%																				
		D.F.	0.05 max.																				
		I.R.	More than 2,000MΩ																				
		Dielectric Strength	In accordance with item No.4																				
			<table border="1" style="border-collapse: collapse; width: 100%;"> <thead> <tr> <th>Step</th> <th>Temperature (°C)</th> <th>Time (min.)</th> </tr> </thead> <tbody> <tr> <td style="text-align: center;">1</td> <td style="text-align: center;">Min. Operating Temp.±3</td> <td style="text-align: center;">30±3</td> </tr> <tr> <td style="text-align: center;">2</td> <td style="text-align: center;">Room Temp.</td> <td style="text-align: center;">2 to 3</td> </tr> <tr> <td style="text-align: center;">3</td> <td style="text-align: center;">Max. Operating Temp.±2</td> <td style="text-align: center;">30±3</td> </tr> <tr> <td style="text-align: center;">4</td> <td style="text-align: center;">Room Temp.</td> <td style="text-align: center;">2 to 3</td> </tr> </tbody> </table> <p style="padding: 5px;">•Pretreatment Perform a heat treatment at 150 ± 18°C for 60±5 min. and then let sit for 24±2 hrs. at *room condition.</p>  <p style="text-align: center;">Fig. 4</p>	Step	Temperature (°C)	Time (min.)	1	Min. Operating Temp.±3	30±3	2	Room Temp.	2 to 3	3	Max. Operating Temp.±2	30±3	4	Room Temp.	2 to 3					
Step	Temperature (°C)	Time (min.)																					
1	Min. Operating Temp.±3	30±3																					
2	Room Temp.	2 to 3																					
3	Max. Operating Temp.±2	30±3																					
4	Room Temp.	2 to 3																					

\* "Room condition" Temperature : 15 to 35°C, Relative humidity : 45 to 75%, Atmospheric pressure : 86 to 106kPa

Continued on the following page.

## Specifications and Test Methods

Continued from the preceding page.

No.	Item	Specifications	Test Method									
17	Humidity (Steady State)	Appearance	No marking defects									
		Capacitance Change	Within $\pm 15\%$									
		D.F.	0.05 max.									
		I.R.	More than 1,000M $\Omega$									
		Dielectric Strength	In accordance with item No.4									
			Let the capacitor sit at $40\pm 2^\circ\text{C}$ and relative humidity of 90 to 95% for $500\pm 24$ hrs. Remove and let sit for $24\pm 2$ hrs. at *room condition, then measure. •Pretreatment Perform a heat treatment at $150\pm 18^\circ\text{C}$ for $60\pm 5$ min. and then let sit for $24\pm 2$ hrs. at *room condition.									
18	Life	Appearance	No marking defects									
		Capacitance Change	Within $\pm 20\%$									
		D.F.	0.05 max.									
		I.R.	More than 1,000M $\Omega$									
		Dielectric Strength	In accordance with item No.4									
			Apply voltage and time as Table at $85\pm 2^\circ\text{C}$ . Remove and let sit for $24\pm 2$ hrs. at *room condition, then measure. The charge / discharge current is less than 50mA. <table border="1" style="margin-left: auto; margin-right: auto;"> <thead> <tr> <th>Nominal Capacitance</th> <th>Test Time</th> <th>Test voltage</th> </tr> </thead> <tbody> <tr> <td><math>C \geq 10,000\text{pF}</math></td> <td><math>1,000\pm 48</math> hrs.</td> <td>AC300V (r.m.s.)</td> </tr> <tr> <td><math>C &lt; 10,000\text{pF}</math></td> <td><math>1,500\pm 48</math> hrs.</td> <td>AC500V (r.m.s.)*</td> </tr> </tbody> </table> * Except that once each hour the voltage is increased to AC1,000V (r.m.s.) for 0.1 sec. •Pretreatment Apply test voltage for $60\pm 5$ min. at test temperature. Remove and let sit for $24\pm 2$ hrs. at *room condition.	Nominal Capacitance	Test Time	Test voltage	$C \geq 10,000\text{pF}$	$1,000\pm 48$ hrs.	AC300V (r.m.s.)	$C < 10,000\text{pF}$	$1,500\pm 48$ hrs.	AC500V (r.m.s.)*
Nominal Capacitance	Test Time	Test voltage										
$C \geq 10,000\text{pF}$	$1,000\pm 48$ hrs.	AC300V (r.m.s.)										
$C < 10,000\text{pF}$	$1,500\pm 48$ hrs.	AC500V (r.m.s.)*										
19	Humidity Loading	Appearance	No marking defects									
		Capacitance Change	Within $\pm 15\%$									
		D.F.	0.05 max.									
		I.R.	More than 1,000M $\Omega$									
		Dielectric Strength	In accordance with item No.4									
			Apply the rated voltage at $40\pm 2^\circ\text{C}$ and relative humidity of 90 to 95% for $500\pm 24$ hrs. Remove and let sit for $24\pm 2$ hrs. at *room condition, then measure. •Pretreatment Apply test voltage for $60\pm 5$ min. at test temperature. Remove and let sit for $24\pm 2$ hrs. at *room condition.									

\* "Room condition" Temperature : 15 to 35°C, Relative humidity : 45 to 75%, Atmospheric pressure : 86 to 106kPa

# Chip Monolithic Ceramic Capacitors



## Safety Standard Recognized Type GC (UL, IEC60384-14 Class X1/Y2)

### ■ Features

1. Chip monolithic ceramic capacitor (certified as conforming to safety standards) for AC lines.
2. A new monolithic structure for small, high capacitance capable of operating at high voltage levels.
3. Compared to lead type capacitors, this new capacitor is greatly downsized and low-profiled to 1/10 or less in volume, and 1/4 or less in height.
4. The type GC can be used as an X1-class and Y2-class capacitor, line-by-pass capacitor of UL1414.
5. +125 degree C guaranteed.
6. Only for reflow soldering.

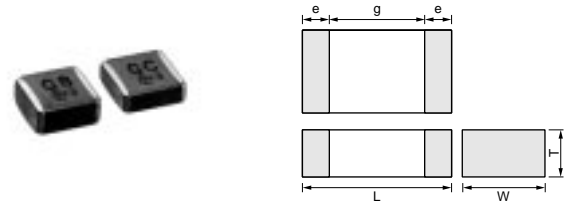

Part Number	Dimensions (mm)				
	L	W	T	e min.	g min.
<b>GA355D</b>	5.7 ±0.4	5.0 ±0.4	2.0 ±0.3	0.3	4.0

### ■ Applications

1. Ideal for use as Y capacitor or X capacitor for various switching power supplies
2. Ideal for modem applications

### ■ Standard Recognition

	Standard No.	Status of Recognition		Rated Voltage
		Type GB	Type GC	
UL	UL1414	—	◎*	AC250V (r.m.s.)
BSI	EN132400	—	◎	
VDE		◎	◎	
SEV		◎	◎	
SEMKO		◎	◎	
EN132400 Class		X2	X1, Y2	

\*: Line-By-Pass only

Part Number	Rated Voltage (V)	TC Code (Standard)	Capacitance (pF)	Length L (mm)	Width W (mm)	Thickness T (mm)	Electrode g min. (mm)	Electrode e (mm)
<b>GA355DR7GC101KY02L</b>	AC250 (r.m.s.)	X7R (EIA)	100 ±10%	5.7	5.0	2.0	4.0	0.3 min.
<b>GA355DR7GC151KY02L</b>	AC250 (r.m.s.)	X7R (EIA)	150 ±10%	5.7	5.0	2.0	4.0	0.3 min.
<b>GA355DR7GC221KY02L</b>	AC250 (r.m.s.)	X7R (EIA)	220 ±10%	5.7	5.0	2.0	4.0	0.3 min.
<b>GA355DR7GC331KY02L</b>	AC250 (r.m.s.)	X7R (EIA)	330 ±10%	5.7	5.0	2.0	4.0	0.3 min.
<b>GA355DR7GC471KY02L</b>	AC250 (r.m.s.)	X7R (EIA)	470 ±10%	5.7	5.0	2.0	4.0	0.3 min.
<b>GA355DR7GC681KY02L</b>	AC250 (r.m.s.)	X7R (EIA)	680 ±10%	5.7	5.0	2.0	4.0	0.3 min.
<b>GA355DR7GC102KY02L</b>	AC250 (r.m.s.)	X7R (EIA)	1000 ±10%	5.7	5.0	2.0	4.0	0.3 min.
<b>GA355DR7GC152KY02L</b>	AC250 (r.m.s.)	X7R (EIA)	1500 ±10%	5.7	5.0	2.0	4.0	0.3 min.
<b>GA355DR7GC222KY02L</b>	AC250 (r.m.s.)	X7R (EIA)	2200 ±10%	5.7	5.0	2.0	4.0	0.3 min.
<b>GA355DR7GC332KY02L</b>	AC250 (r.m.s.)	X7R (EIA)	3300 ±10%	5.7	5.0	2.0	4.0	0.3 min.
<b>GA355DR7GC472KY02L</b>	AC250 (r.m.s.)	X7R (EIA)	4700 ±10%	5.7	5.0	2.0	4.0	0.3 min.

# Chip Monolithic Ceramic Capacitors



## Safety Standard Recognized Type GD (IEC60384-14 Class Y3)

### ■ Features

1. A new monolithic structure for small, high capacitance capable of operating at high voltage levels.
2. The type GD can be used as a Y3-class capacitor.
3. Available for equipment based on IEC/EN60950 and UL1950.
4. +125 degree C guaranteed.
5. Only for reflow soldering.
6. The low-profile type (thickness: 1.5mm max.) is available. Fit for use on thinner type equipment.

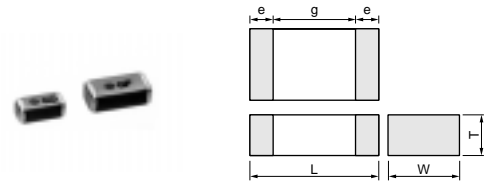

Part Number	Dimensions (mm)				
	L	W	T	e min.	g min.
<b>GA342D</b>	4.5 ±0.3	2.0 ±0.2	2.0 ±0.2*	0.3	2.5
<b>GA342Q</b>			1.5 +0, -0.3		
<b>GA343D</b>	4.5 ±0.4	3.2 ±0.3	2.0 +0, -0.3		
<b>GA343Q</b>			1.5 +0, -0.3		

\* GA342D1X : 2.0±0.3

### ■ Applications

1. Ideal for use on line filters and couplings for DAA modems without transformers.
2. Ideal for use on line filters for information equipment.

### ■ Standard Recognition

	Standard No.	Class	Status of Recognition	Rated Voltage
			Type GD	
SEMKO	EN132400	Y3	⊙	AC250V (r.m.s.)

#### Applications

Size	Switching power supplies	Communication network devices such as a modem
4.5×3.2mm and under	—	⊙

Part Number	Rated Voltage (V)	TC Code (Standard)	Capacitance (pF)	Length L (mm)	Width W (mm)	Thickness T (mm)	Electrode g min. (mm)	Electrode e (mm)
<b>GA342D1XGD100JY02L</b>	AC250 (r.m.s.)	SL (JIS)	10 ±5%	4.5	2.0	2.0	2.5	0.3 min.
<b>GA342D1XGD120JY02L</b>	AC250 (r.m.s.)	SL (JIS)	12 ±5%	4.5	2.0	2.0	2.5	0.3 min.
<b>GA342D1XGD150JY02L</b>	AC250 (r.m.s.)	SL (JIS)	15 ±5%	4.5	2.0	2.0	2.5	0.3 min.
<b>GA342D1XGD180JY02L</b>	AC250 (r.m.s.)	SL (JIS)	18 ±5%	4.5	2.0	2.0	2.5	0.3 min.
<b>GA342D1XGD220JY02L</b>	AC250 (r.m.s.)	SL (JIS)	22 ±5%	4.5	2.0	2.0	2.5	0.3 min.
<b>GA342D1XGD270JY02L</b>	AC250 (r.m.s.)	SL (JIS)	27 ±5%	4.5	2.0	2.0	2.5	0.3 min.
<b>GA342D1XGD330JY02L</b>	AC250 (r.m.s.)	SL (JIS)	33 ±5%	4.5	2.0	2.0	2.5	0.3 min.
<b>GA342D1XGD390JY02L</b>	AC250 (r.m.s.)	SL (JIS)	39 ±5%	4.5	2.0	2.0	2.5	0.3 min.
<b>GA342D1XGD470JY02L</b>	AC250 (r.m.s.)	SL (JIS)	47 ±5%	4.5	2.0	2.0	2.5	0.3 min.
<b>GA342D1XGD560JY02L</b>	AC250 (r.m.s.)	SL (JIS)	56 ±5%	4.5	2.0	2.0	2.5	0.3 min.
<b>GA342D1XGD680JY02L</b>	AC250 (r.m.s.)	SL (JIS)	68 ±5%	4.5	2.0	2.0	2.5	0.3 min.
<b>GA342D1XGD820JY02L</b>	AC250 (r.m.s.)	SL (JIS)	82 ±5%	4.5	2.0	2.0	2.5	0.3 min.
<b>GA342QR7GD101KW01L</b>	AC250 (r.m.s.)	X7R (EIA)	100 ±10%	4.5	2.0	1.5	2.5	0.3 min.
<b>GA342QR7GD151KW01L</b>	AC250 (r.m.s.)	X7R (EIA)	150 ±10%	4.5	2.0	1.5	2.5	0.3 min.
<b>GA342QR7GD221KW01L</b>	AC250 (r.m.s.)	X7R (EIA)	220 ±10%	4.5	2.0	1.5	2.5	0.3 min.
<b>GA342QR7GD331KW01L</b>	AC250 (r.m.s.)	X7R (EIA)	330 ±10%	4.5	2.0	1.5	2.5	0.3 min.
<b>GA342QR7GD471KW01L</b>	AC250 (r.m.s.)	X7R (EIA)	470 ±10%	4.5	2.0	1.5	2.5	0.3 min.
<b>GA342QR7GD681KW01L</b>	AC250 (r.m.s.)	X7R (EIA)	680 ±10%	4.5	2.0	1.5	2.5	0.3 min.
<b>GA342QR7GD102KW01L</b>	AC250 (r.m.s.)	X7R (EIA)	1000 ±10%	4.5	2.0	1.5	2.5	0.3 min.
<b>GA342QR7GD152KW01L</b>	AC250 (r.m.s.)	X7R (EIA)	1500 ±10%	4.5	2.0	1.5	2.5	0.3 min.
<b>GA343QR7GD182KW01L</b>	AC250 (r.m.s.)	X7R (EIA)	1800 ±10%	4.5	3.2	1.5	2.5	0.3 min.
<b>GA343QR7GD222KW01L</b>	AC250 (r.m.s.)	X7R (EIA)	2200 ±10%	4.5	3.2	1.5	2.5	0.3 min.
<b>GA343DR7GD472KW01L</b>	AC250 (r.m.s.)	X7R (EIA)	4700 ±10%	4.5	3.2	2.0	2.5	0.3 min.

# Chip Monolithic Ceramic Capacitors



## Safety Standard Recognized Type GF (IEC60384-14 Class Y2)

### ■ Features

1. A new monolithic structure for small, high capacitance capable of operating at high voltage levels.
2. The type GF can be used as a Y2-class capacitor.
3. Available for equipment based on IEC/EN60950 and UL1950. Besides, the GA352/355 types are available for equipment based on IEC/EN60065, UL1492, and UL6500.
4. +125 degree C guaranteed.
5. Only for reflow soldering.
6. The low-profile type (thickness: 1.5mm max.) is available. Fit for use on thinner type equipment.

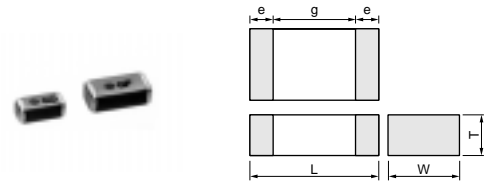

Part Number	Dimensions (mm)				
	L	W	T	e min.	g min.
<b>GA342D</b>	4.5 ±0.3	2.0 ±0.2	2.0 ±0.2*	0.3	2.5
<b>GA342Q</b>			1.5 +0, -0.3		
<b>GA352Q</b>	5.7 ±0.4	2.8 ±0.3	1.5 +0, -0.3		4.0
<b>GA355Q</b>			5.0 ±0.4	1.5 +0, -0.3	

\* GA342D1X : 2.0±0.3

### ■ Standard Recognition

	Standard No.	Class	Status of Recognition		Rated Voltage
			Type GF		
			Size : 4.5x2.0mm	Size : 5.7x2.8mm and over	
UL	UL1414	X1, Y2	—	⊙	AC250V (r.m.s.)
SEMKO	EN132400	Y2	⊙	⊙	

#### Applications

Size	Switching power supplies	Communication network devices such as a modem
4.5x2.0mm	—	⊙
5.7x2.8mm and over	⊙	⊙

Part Number	Rated Voltage (V)	TC Code (Standard)	Capacitance (pF)	Length L (mm)	Width W (mm)	Thickness T (mm)	Electrode g min. (mm)	Electrode e (mm)
<b>GA342D1XGF100JY02L</b>	AC250 (r.m.s.)	SL (JIS)	10 ±5%	4.5	2.0	2.0	2.5	0.3 min.
<b>GA342D1XGF120JY02L</b>	AC250 (r.m.s.)	SL (JIS)	12 ±5%	4.5	2.0	2.0	2.5	0.3 min.
<b>GA342D1XGF150JY02L</b>	AC250 (r.m.s.)	SL (JIS)	15 ±5%	4.5	2.0	2.0	2.5	0.3 min.
<b>GA342D1XGF180JY02L</b>	AC250 (r.m.s.)	SL (JIS)	18 ±5%	4.5	2.0	2.0	2.5	0.3 min.
<b>GA342D1XGF220JY02L</b>	AC250 (r.m.s.)	SL (JIS)	22 ±5%	4.5	2.0	2.0	2.5	0.3 min.
<b>GA342D1XGF270JY02L</b>	AC250 (r.m.s.)	SL (JIS)	27 ±5%	4.5	2.0	2.0	2.5	0.3 min.
<b>GA342D1XGF330JY02L</b>	AC250 (r.m.s.)	SL (JIS)	33 ±5%	4.5	2.0	2.0	2.5	0.3 min.
<b>GA342D1XGF390JY02L</b>	AC250 (r.m.s.)	SL (JIS)	39 ±5%	4.5	2.0	2.0	2.5	0.3 min.
<b>GA342D1XGF470JY02L</b>	AC250 (r.m.s.)	SL (JIS)	47 ±5%	4.5	2.0	2.0	2.5	0.3 min.
<b>GA342D1XGF560JY02L</b>	AC250 (r.m.s.)	SL (JIS)	56 ±5%	4.5	2.0	2.0	2.5	0.3 min.
<b>GA342D1XGF680JY02L</b>	AC250 (r.m.s.)	SL (JIS)	68 ±5%	4.5	2.0	2.0	2.5	0.3 min.
<b>GA342D1XGF820JY02L</b>	AC250 (r.m.s.)	SL (JIS)	82 ±5%	4.5	2.0	2.0	2.5	0.3 min.
<b>GA342QR7GF101KW01L</b>	AC250 (r.m.s.)	X7R (EIA)	100 ±10%	4.5	2.0	1.5	2.5	0.3 min.
<b>GA342QR7GF151KW01L</b>	AC250 (r.m.s.)	X7R (EIA)	150 ±10%	4.5	2.0	1.5	2.5	0.3 min.
<b>GA342DR7GF221KW02L</b>	AC250 (r.m.s.)	X7R (EIA)	220 ±10%	4.5	2.0	2.0	2.5	0.3 min.
<b>GA342DR7GF331KW02L</b>	AC250 (r.m.s.)	X7R (EIA)	330 ±10%	4.5	2.0	2.0	2.5	0.3 min.
<b>GA352QR7GF471KW01L</b>	AC250 (r.m.s.)	X7R (EIA)	470 ±10%	5.7	2.8	1.5	4.0	0.3 min.
<b>GA352QR7GF681KW01L</b>	AC250 (r.m.s.)	X7R (EIA)	680 ±10%	5.7	2.8	1.5	4.0	0.3 min.
<b>GA352QR7GF102KW01L</b>	AC250 (r.m.s.)	X7R (EIA)	1000 ±10%	5.7	2.8	1.5	4.0	0.3 min.
<b>GA352QR7GF152KW01L</b>	AC250 (r.m.s.)	X7R (EIA)	1500 ±10%	5.7	2.8	1.5	4.0	0.3 min.
<b>GA355QR7GF182KW01L</b>	AC250 (r.m.s.)	X7R (EIA)	1800 ±10%	5.7	5.0	1.5	4.0	0.3 min.
<b>GA355QR7GF222KW01L</b>	AC250 (r.m.s.)	X7R (EIA)	2200 ±10%	5.7	5.0	1.5	4.0	0.3 min.
<b>GA355QR7GF332KW01L</b>	AC250 (r.m.s.)	X7R (EIA)	3300 ±10%	5.7	5.0	1.5	4.0	0.3 min.

# Chip Monolithic Ceramic Capacitors



## Safety Standard Recognized Type GB (IEC60384-14 Class X2)

### ■ Features

1. Chip monolithic ceramic capacitor (certified as conforming to safety standards) for AC lines.
2. A new monolithic structure for small, high capacitance capable of operating at high voltage levels.
3. Compared to lead type capacitors, this new capacitor is greatly downsized and low-profiled to 1/10 or less in volume, and 1/4 or less in height.
4. The type GB can be used as an X2-class capacitor.
5. +125 degree C guaranteed.
6. Only for reflow soldering.

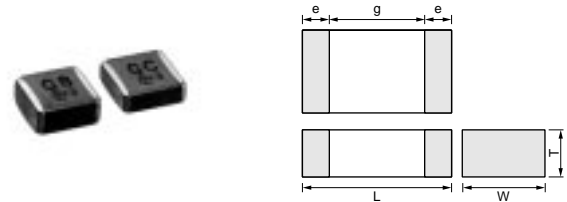

Part Number	Dimensions (mm)				
	L	W	T	e min.	g min.
<b>GA355D</b>	5.7 ±0.4	5.0 ±0.4	2.0 ±0.3	0.3	4.0
<b>GA355X</b>			2.7 ±0.3		

### ■ Applications

Ideal for use as X capacitor for various switching power supplies.

### ■ Standard Recognition

	Standard No.	Status of Recognition		Rated Voltage
		Type GB	Type GC	
UL	UL1414	—	◎*	AC250V (r.m.s.)
BSI	EN132400	—	◎	
VDE		◎	◎	
SEV		◎	◎	
SEMKO		◎	◎	
EN132400 Class		X2	X1, Y2	

\*: Line-By-Pass only

Part Number	Rated Voltage (V)	TC Code (Standard)	Capacitance (pF)	Length L (mm)	Width W (mm)	Thickness T (mm)	Electrode g min. (mm)	Electrode e (mm)
<b>GA355DR7GB103KY02L</b>	AC250 (r.m.s.)	X7R (EIA)	10000 ±10%	5.7	5.0	2.0	4.0	0.3 min.
<b>GA355DR7GB153KY02L</b>	AC250 (r.m.s.)	X7R (EIA)	15000 ±10%	5.7	5.0	2.0	4.0	0.3 min.
<b>GA355DR7GB223KY02L</b>	AC250 (r.m.s.)	X7R (EIA)	22000 ±10%	5.7	5.0	2.0	4.0	0.3 min.
<b>GA355XR7GB333KY06L</b>	AC250 (r.m.s.)	X7R (EIA)	33000 ±10%	5.7	5.0	2.7	4.0	0.3 min.

## GA3 Series Specifications and Test Methods

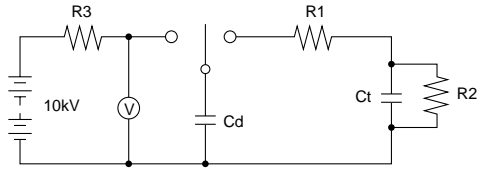
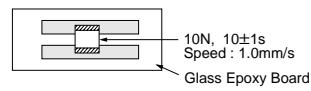
No.	Item	Specifications	Test Method								
1	Operating Temperature Range	-55 to +125°C	-								
2	Appearance	No defects or abnormalities	Visual inspection								
3	Dimensions	Within the specified dimensions	Using calipers								
4	Dielectric Strength	No defects or abnormalities	<p>No failure should be observed when voltage in table is applied between the terminations for 60±1 sec., provided the charge/discharge current is less than 50mA.</p> <table border="1" style="margin-left: auto; margin-right: auto;"> <thead> <tr> <th></th> <th>Test voltage</th> </tr> </thead> <tbody> <tr> <td>Type GB</td> <td>DC1075V</td> </tr> <tr> <td>Type GC/GD/GF</td> <td>AC1500V (r.m.s.)</td> </tr> </tbody> </table>		Test voltage	Type GB	DC1075V	Type GC/GD/GF	AC1500V (r.m.s.)		
	Test voltage										
Type GB	DC1075V										
Type GC/GD/GF	AC1500V (r.m.s.)										
5	Pulse Voltage (Application: Type GD/GF)	No self healing break downs or flash-overs have taken place in the capacitor.	<p>10 impulse of alternating polarity is subjected. (5 impulse for each polarity) The interval between impulse is 60 sec. Applied Voltage : 2.5kV zero to peak</p>								
6	Insulation Resistance (I.R.)	More than 6,000MΩ	The insulation resistance should be measured with DC500±50V and within 60±5 sec. of charging.								
7	Capacitance	Within the specified tolerance	The capacitance/Q/D.F. should be measured at 20°C at a frequency of 1±0.2kHz (SL char. : 1±0.2MHz) and a voltage of AC1±0.2V (r.m.s.).								
8	Dissipation Factor (D.F.) Q	<table border="1" style="margin-left: auto; margin-right: auto;"> <thead> <tr> <th>Char.</th> <th>Specification</th> </tr> </thead> <tbody> <tr> <td>X7R</td> <td>D.F. ≤ 0.025</td> </tr> <tr> <td rowspan="2">SL</td> <td>Q ≥ 400+20C*2 (C &lt; 30pF)</td> </tr> <tr> <td>Q ≥ 1000 (C ≥ 30pF)</td> </tr> </tbody> </table>	Char.	Specification	X7R	D.F. ≤ 0.025	SL	Q ≥ 400+20C*2 (C < 30pF)	Q ≥ 1000 (C ≥ 30pF)	<p>•Pretreatment for X7R char. Perform a heat treatment at 150 ± 10°C for 60±5 min. and then let sit for 24±2 hrs. at *room condition.</p>	
Char.	Specification										
X7R	D.F. ≤ 0.025										
SL	Q ≥ 400+20C*2 (C < 30pF)										
	Q ≥ 1000 (C ≥ 30pF)										
9	Capacitance Temperature Characteristics	<table border="1" style="margin-left: auto; margin-right: auto;"> <thead> <tr> <th>Char.</th> <th>Capacitance Change</th> </tr> </thead> <tbody> <tr> <td>X7R</td> <td>Within ±15%</td> </tr> </tbody> </table> <p>Temperature characteristic guarantee is -55 to +125°C</p> <table border="1" style="margin-left: auto; margin-right: auto;"> <thead> <tr> <th>Char.</th> <th>Temperature Coefficient</th> </tr> </thead> <tbody> <tr> <td>SL</td> <td>+350 to -1000ppm/°C</td> </tr> </tbody> </table> <p>Temperature characteristic guarantee is +20 to +85°C</p>	Char.	Capacitance Change	X7R	Within ±15%	Char.	Temperature Coefficient	SL	+350 to -1000ppm/°C	<p>The range of capacitance change compared with the 25°C (SL char. : 20°C) value within -55 to +125°C should be within the specified range. •Pretreatment for X7R char. Perform a heat treatment at 150 ± 10°C for 60±5 min. and then let sit for 24±2 hrs. at *room condition.</p>
Char.	Capacitance Change										
X7R	Within ±15%										
Char.	Temperature Coefficient										
SL	+350 to -1000ppm/°C										
10	Appearance	No defects or abnormalities	<p>As in Fig., discharge is made 50 times at 5 sec. intervals from the capacitor (Cd) charged at DC voltage of specified.</p>  <p style="text-align: center;">Ct : Capacitor under test Cd : 0.001μF R1 : 1,000Ω R2 : 100MΩ R3 : Surge resistance</p>								
	I.R.	More than 1,000MΩ									
	Dielectric Strength	In accordance with item No.4									
11	Adhesive Strength of Termination	No removal of the terminations or other defect should occur.	<p>Solder the capacitor to the testing jig (glass epoxy board) shown in Fig. 1 using a eutectic solder. Then apply 10N force in the direction of the arrow. The soldering should be done either with an iron or using the reflow method and should be conducted with care so that the soldering is uniform and free of defects such as heat shock.</p>  <p style="text-align: center;">10N, 10±1s Speed : 1.0mm/s Glass Epoxy Board</p> <p style="text-align: center;">Fig. 1</p>								

\*1 "Room condition" Temperature : 15 to 35°C, Relative humidity : 45 to 75%, Atmospheric pressure : 86 to 106kPa

\*2 "C" expresses nominal capacitance value (pF).

Continued on the following page.

## GA3 Series Specifications and Test Methods

Continued from the preceding page.

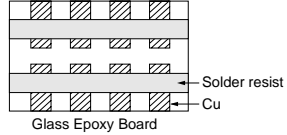
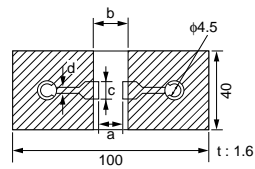
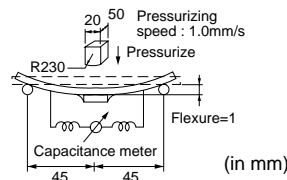
No.	Item	Specifications	Test Method																							
12	Appearance	No defects or abnormalities	Solder the capacitor to the test jig (glass epoxy board). The capacitor should be subjected to a simple harmonic motion having a total amplitude of 1.5mm, the frequency being varied uniformly between the approximate limits of 10 and 55Hz. The frequency range, from 10 to 55Hz and return to 10Hz, should be traversed in approximately 1 min. This motion should be applied for a period of 2 hrs. in each 3 mutually perpendicular directions (total of 6 hrs.).																							
	Capacitance	Within the specified tolerance																								
12	D.F. Q	<table border="1"> <thead> <tr> <th>Char.</th> <th>Specification</th> </tr> </thead> <tbody> <tr> <td>X7R</td> <td>D.F. ≤ 0.025</td> </tr> <tr> <td>SL</td> <td>Q ≥ 400+20C*2 (C &lt; 30pF) Q ≥ 1000 (C ≥ 30pF)</td> </tr> </tbody> </table>	Char.	Specification	X7R	D.F. ≤ 0.025	SL	Q ≥ 400+20C*2 (C < 30pF) Q ≥ 1000 (C ≥ 30pF)																		
		Char.	Specification																							
X7R	D.F. ≤ 0.025																									
SL	Q ≥ 400+20C*2 (C < 30pF) Q ≥ 1000 (C ≥ 30pF)																									
13	Deflection	No cracking or marking defects should occur.	Solder the capacitor to the testing jig (glass epoxy board) shown in Fig. 2 using a eutectic solder. Then apply a force in the direction shown in Fig. 3. The soldering should be done either with an iron or using the reflow method and should be conducted with care so that the soldering is uniform and free of defects such as heat shock.																							
		 <table border="1"> <thead> <tr> <th rowspan="2">L×W (mm)</th> <th colspan="4">Dimension (mm)</th> </tr> <tr> <th>a</th> <th>b</th> <th>c</th> <th>d</th> </tr> </thead> <tbody> <tr> <td>4.5×2.0</td> <td>3.5</td> <td>7.0</td> <td>2.4</td> <td rowspan="4">1.0</td> </tr> <tr> <td>4.5×3.2</td> <td>3.5</td> <td>7.0</td> <td>3.7</td> </tr> <tr> <td>5.7×2.8</td> <td>4.5</td> <td>8.0</td> <td>3.2</td> </tr> <tr> <td>5.7×5.0</td> <td>4.5</td> <td>8.0</td> <td>5.6</td> </tr> </tbody> </table> <p>Fig. 2</p>		L×W (mm)	Dimension (mm)				a	b	c	d	4.5×2.0	3.5	7.0	2.4	1.0	4.5×3.2	3.5	7.0	3.7	5.7×2.8	4.5	8.0	3.2	5.7×5.0
L×W (mm)	Dimension (mm)																									
	a	b	c	d																						
4.5×2.0	3.5	7.0	2.4	1.0																						
4.5×3.2	3.5	7.0	3.7																							
5.7×2.8	4.5	8.0	3.2																							
5.7×5.0	4.5	8.0	5.6																							
			 <p>Fig. 3</p>																							
14	Solderability of Termination	75% of the terminations are to be soldered evenly and continuously.	Immerse the capacitor in a solution of ethanol (JIS-K-8101) and rosin (JIS-K-5902) (25% rosin in weight proportion). Immerse in eutectic solder solution for 2±0.5 sec. at 235±5°C. Immersing speed : 25±2.5mm/s																							
15	Appearance	No marking defects	Preheat the capacitor as table. Immerse the capacitor in eutectic solder solution at 260±5°C for 10±1 sec. Let sit at *1 room condition for 24±2 hrs., then measure. •Immersing speed : 25±2.5mm/s •Pretreatment for X7R char. Perform a heat treatment at 150±18°C for 60±5 min. and then let sit for 24±2 hrs. at *1 room condition.																							
	Capacitance Change	<table border="1"> <thead> <tr> <th>Char.</th> <th>Capacitance Change</th> </tr> </thead> <tbody> <tr> <td>X7R</td> <td>Within ±10%</td> </tr> <tr> <td>SL</td> <td>Within ±2.5% or ±0.25pF (Whichever is larger)</td> </tr> </tbody> </table>		Char.	Capacitance Change	X7R	Within ±10%	SL	Within ±2.5% or ±0.25pF (Whichever is larger)																	
Char.	Capacitance Change																									
X7R	Within ±10%																									
SL	Within ±2.5% or ±0.25pF (Whichever is larger)																									
	I.R.	More than 1,000MΩ	<table border="1"> <thead> <tr> <th>Step</th> <th>Temperature</th> <th>Time</th> </tr> </thead> <tbody> <tr> <td>1</td> <td>100°C to 120°C</td> <td>1 min.</td> </tr> <tr> <td>2</td> <td>170°C to 200°C</td> <td>1 min.</td> </tr> </tbody> </table>	Step	Temperature	Time	1	100°C to 120°C	1 min.	2	170°C to 200°C	1 min.														
Step	Temperature	Time																								
1	100°C to 120°C	1 min.																								
2	170°C to 200°C	1 min.																								
	Dielectric Strength	In accordance with item No.4																								

\*1 "Room condition" Temperature : 15 to 35°C, Relative humidity : 45 to 75%, Atmospheric pressure : 86 to 106kPa

\*2 "C" expresses nominal capacitance value (pF).

Continued on the following page. 



## GA3 Series Specifications and Test Methods

Continued from the preceding page.

No.	Item	Specifications	Test Method	
16	Temperature Cycle	Appearance	No marking defects	
		Capacitance Change	Char.	Capacitance Change
			X7R	Within $\pm 15\%$
			SL	Within $\pm 2.5\%$ or $\pm 0.25\text{pF}$ (Whichever is larger)
		D.F. Q	Char.	Specification
X7R	D.F. $\leq 0.05$			
	SL	$Q \geq 400 + 20C^{*2}$ ( $C < 30\text{pF}$ ) $Q \geq 1000$ ( $C \geq 30\text{pF}$ )		
	I.R.	More than 3,000M $\Omega$		
	Dielectric Strength	In accordance with item No.4		
17	Humidity (Steady State)	Appearance	No marking defects	
		Capacitance Change	Char.	Capacitance Change
			X7R	Within $\pm 15\%$
			SL	Within $\pm 5.0\%$ or $\pm 0.5\text{pF}$ (Whichever is larger)
		D.F. Q	Char.	Specification
X7R	D.F. $\leq 0.05$			
	SL	$Q \geq 275 + 5/2C^{*2}$ ( $C < 30\text{pF}$ ) $Q \geq 350$ ( $C \geq 30\text{pF}$ )		
	I.R.	More than 3,000M $\Omega$		
	Dielectric Strength	In accordance with item No.4		
18	Life	Appearance	No marking defects	
		Capacitance Change	Char.	Capacitance Change
			X7R	Within $\pm 20\%$
			SL	Within $\pm 3.0\%$ or $\pm 0.3\text{pF}$ (Whichever is larger)
		D.F. Q	Char.	Specification
X7R	D.F. $\leq 0.05$			
	SL	$Q \geq 275 + 5/2C^{*2}$ ( $C < 30\text{pF}$ ) $Q \geq 350$ ( $C \geq 30\text{pF}$ )		
	I.R.	More than 3,000M $\Omega$		
	Dielectric Strength	In accordance with item No.4		

Fix the capacitor to the supporting jig (glass epoxy board) shown in Fig. 4 using a eutectic solder.  
Perform the 5 cycles according to the 4 heat treatments listed in the following table.  
Let sit for 24 $\pm$ 2 hrs. at \*room condition, then measure.

Step	Temperature (°C)	Time (min.)
1	Min. Operating Temp. $\pm 3$	30 $\pm$ 3
2	Room Temp.	2 to 3
3	Max. Operating Temp. $\pm 2$	30 $\pm$ 3
4	Room Temp.	2 to 3

•Pretreatment for X7R char.  
Perform a heat treatment at 150 $\pm$ 1.8°C for 60 $\pm$ 5 min. and then let sit for 24 $\pm$ 2 hrs. at \*room condition.

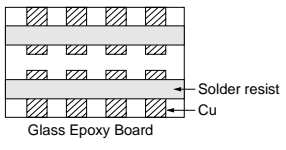
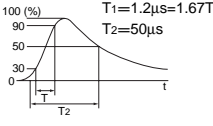

Fig. 4

Let the capacitor sit at 40 $\pm$ 2°C and relative humidity of 90 to 95% for 500 $\pm$ 12 hrs.  
Remove and let sit for 24 $\pm$ 2 hrs. at \*room condition, then measure.  
•Pretreatment for X7R char.  
Perform a heat treatment at 150 $\pm$ 1.8°C for 60 $\pm$ 5 min. and then let sit for 24 $\pm$ 2 hrs. at \*room condition.

Impulse Voltage  
Each individual capacitor should be subjected to a 2.5kV (Type GC/GF : 5kV) Impulses (the voltage value means zero to peak) for three times. Then the capacitors are applied to life test.



Apply voltage as Table for 1,000 hrs. at 125 $\pm$ 2°C, relative humidity 50% max.

Type	Applied voltage
GB	AC312.5V (r.m.s.), except that once each hour the voltage is increased to AC1,000V (r.m.s.) for 0.1 sec.
GC GD GF	AC425V (r.m.s.), except that once each hour the voltage is increased to AC1,000V (r.m.s.) for 0.1 sec.

Let sit for 24 $\pm$ 2 hrs. at \*room condition, then measure.  
•Pretreatment for X7R char.  
Perform a heat treatment at 150 $\pm$ 1.8°C for 60 $\pm$ 5 min. and then let sit for 24 $\pm$ 2 hrs. at \*room condition.

\*1 "Room condition" Temperature : 15 to 35°C, Relative humidity : 45 to 75%, Atmospheric pressure : 86 to 106kPa  
\*2 "C" expresses nominal capacitance value (pF).

Continued on the following page. ↗

## GA3 Series Specifications and Test Methods

Continued from the preceding page.

No.	Item	Specifications	Test Method						
19	Appearance	No marking defects	Apply the rated voltage at 40±2°C and relative humidity of 90 to 95% for 500 <sup>±2</sup> / <sub>4</sub> hrs. Remove and let sit for 24±2 hrs. at *1room condition, then measure. •Pretreatment for X7R char. Perform a heat treatment at 150 <sup>±1</sup> / <sub>8</sub> °C for 60±5 min. and then let sit for 24±2 hrs. at *1room condition.						
	Capacitance Change	<table border="1"> <thead> <tr> <th>Char.</th> <th>Capacitance Change</th> </tr> </thead> <tbody> <tr> <td>X7R</td> <td>Within ±15%</td> </tr> <tr> <td>SL</td> <td>Within ±5.0% or ±0.5pF (Whichever is larger)</td> </tr> </tbody> </table>		Char.	Capacitance Change	X7R	Within ±15%	SL	Within ±5.0% or ±0.5pF (Whichever is larger)
		Char.		Capacitance Change					
	X7R	Within ±15%							
	SL	Within ±5.0% or ±0.5pF (Whichever is larger)							
D.F. Q	<table border="1"> <thead> <tr> <th>Char.</th> <th>Specification</th> </tr> </thead> <tbody> <tr> <td>X7R</td> <td>D.F. ≤0.05</td> </tr> <tr> <td>SL</td> <td>Q ≥ 275+5/2C*2 (C &lt; 30pF) Q ≥ 350 (C ≥ 30pF)</td> </tr> </tbody> </table>	Char.	Specification	X7R	D.F. ≤0.05	SL	Q ≥ 275+5/2C*2 (C < 30pF) Q ≥ 350 (C ≥ 30pF)		
	Char.	Specification							
X7R	D.F. ≤0.05								
SL	Q ≥ 275+5/2C*2 (C < 30pF) Q ≥ 350 (C ≥ 30pF)								
I.R.	More than 3,000MΩ								
Dielectric Strength	In accordance with item No.4								

\*1 "Room condition" Temperature : 15 to 35°C, Relative humidity : 45 to 75%, Atmospheric pressure : 86 to 106kPa

\*2 "C" expresses nominal capacitance value (pF).

## GRM/GR4/GA2/GA3 Series Data (Typical Example)

### ■ Capacitance-Temperature Characteristics

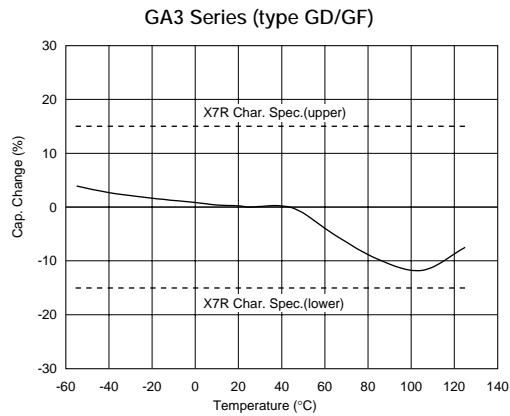
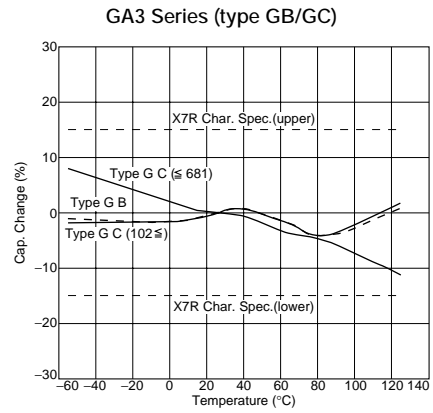
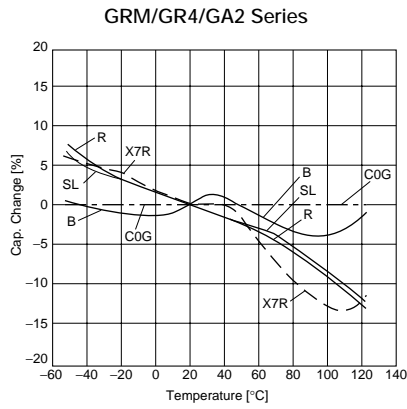

### ■ Impedance-Frequency Characteristics

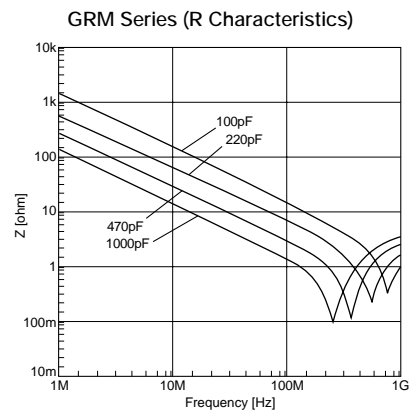
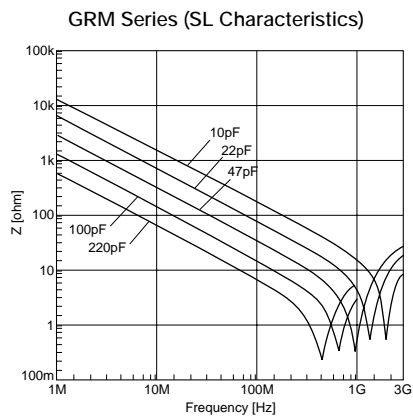

Continued on the following page. ↗

## GRM/GR4/GA2/GA3 Series Data (Typical Example)

Continued from the preceding page.

### Impedance-Frequency Characteristics

GRM Series (X7R Char. 250V)

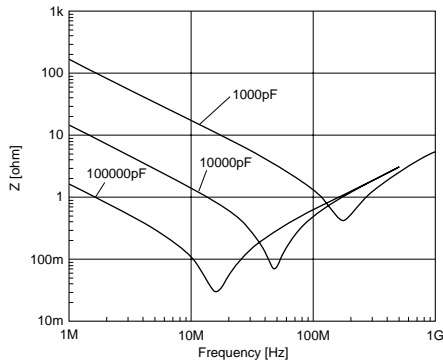

GRM Series (X7R Char. 630V)

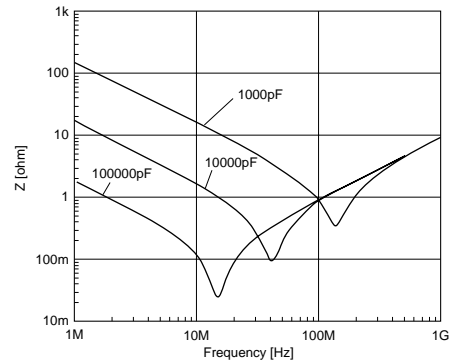

GA2 Series

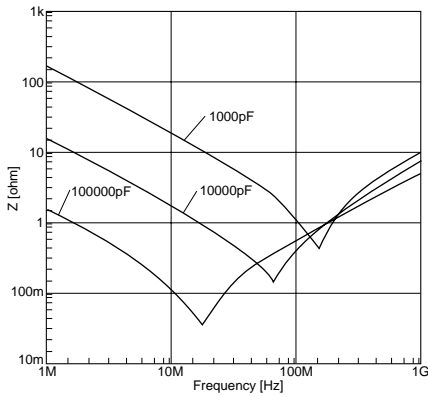

GA3 Series (Type GC)

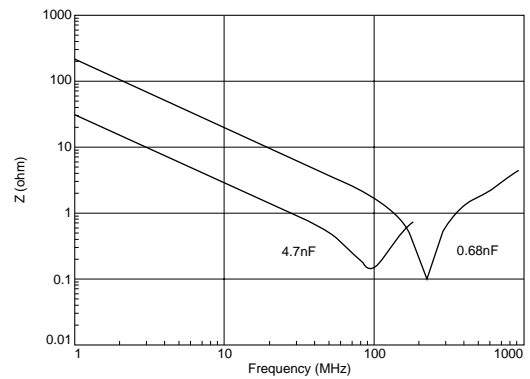

GA3 Series (Type GD)

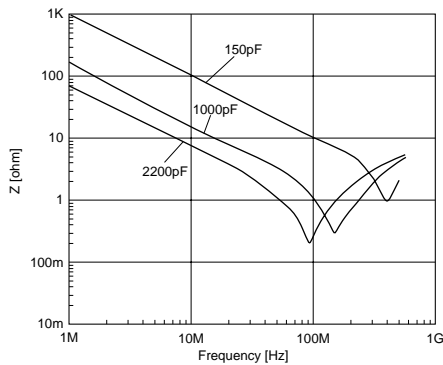

GA3 Series (Type GF)

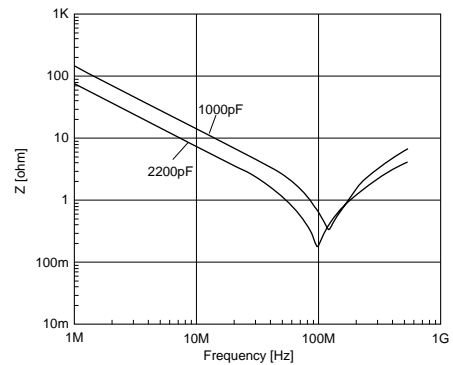

Continued on the following page. ↗

## GRM/GR4/GA2/GA3 Series Data (Typical Example)

Continued from the preceding page.

### ■ Impedance-Frequency Characteristics

GA3 Series (Type GB)

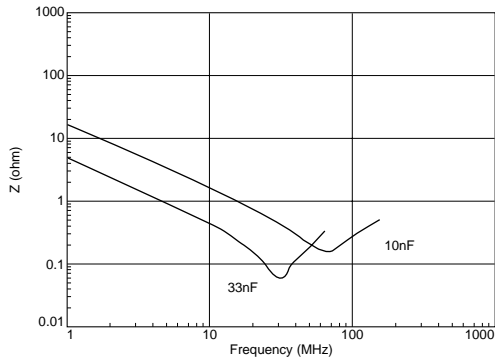

### ■ Capacitance-AC Voltage Characteristics

GA3 Series (Type GC)

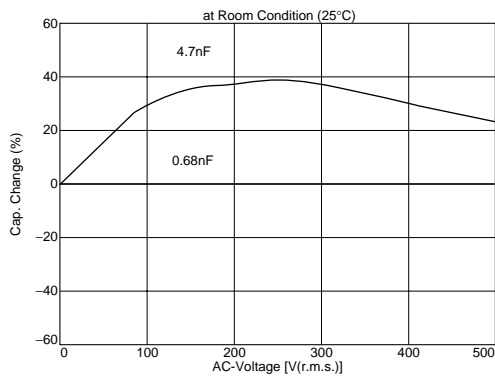

GA3 Series (Type GD/GF, X7R char.)

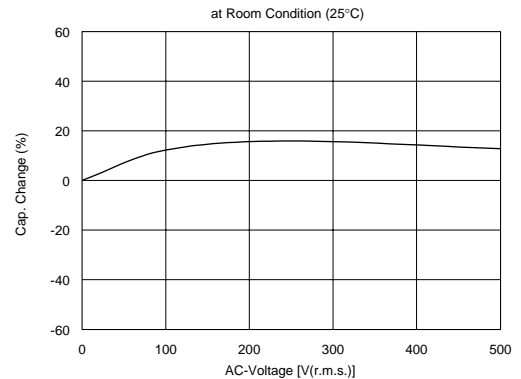

GA3 Series (Type GB)

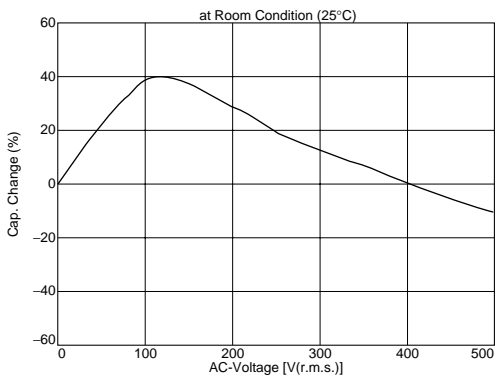

## Package

Taping is standard packaging method.

### ■ Minimum Quantity Guide

Part Number		Dimensions (mm)			Quantity (pcs.)	
		L	W	T	φ180mm reel	
					Paper Tape	Plastic Tape
Medium-voltage	GRM18	1.6	0.8	0.8	4,000	-
	GRM21	2.0	1.25	1.0	4,000	-
				1.25	-	3,000
	GRM31/GR431	3.2	1.6	1.0	4,000	-
				1.25	-	3,000
				1.6	-	2,000
	GRM32/GR432	3.2	2.5	1.5	-	2,000
				2.0	-	1,000
				1.0	-	3,000
	GRM42/GR442	4.5	2.0	1.25	-	2,000
1.5				-	2,000	
2.0				-	2,000	
1.0				-	3,000	
GRM43/GR443	4.5	3.2	1.5	-	1,000	
			2.0	-	1,000	
			2.5	-	500	
GRM55/GR455	5.7	5.0	2.0	-	1,000	
AC250V	GA242	4.5	2.0	1.5	-	2,000
	GA243	4.5	3.2	1.5	-	1,000
				2.0	-	1,000
GA255	5.7	5.0	2.0	-	1,000	
Safety Std. Recognition	GA342	4.5	2.0	1.5	-	2,000
				2.0	-	2,000
	GA343	4.5	3.2	1.5	-	1,000
				2.0	-	1,000
	GA352	5.7	2.8	1.5	-	1,000
				2.0	-	1,000
	GA355	5.7	5.0	1.5	-	1,000
2.0				-	1,000	
			2.7	-	500	

### ■ Tape Carrier Packaging

#### (1) Appearance of Taping

##### ① Plastic Tape

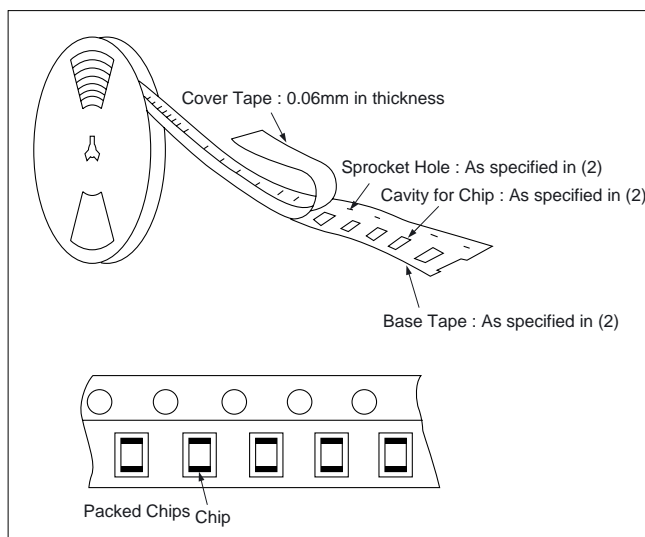

##### ② Paper Tape

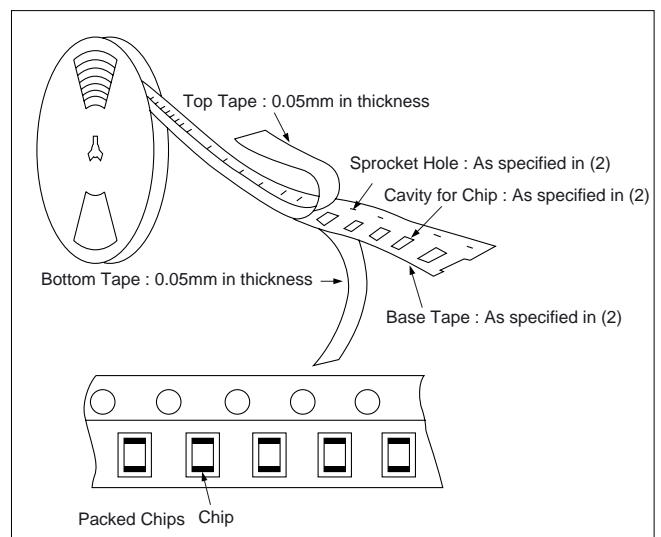

Continued on the following page. ↗

## Package

☑ Continued from the preceding page.

### (2) Dimensions of Tape

#### ① Plastic Tape

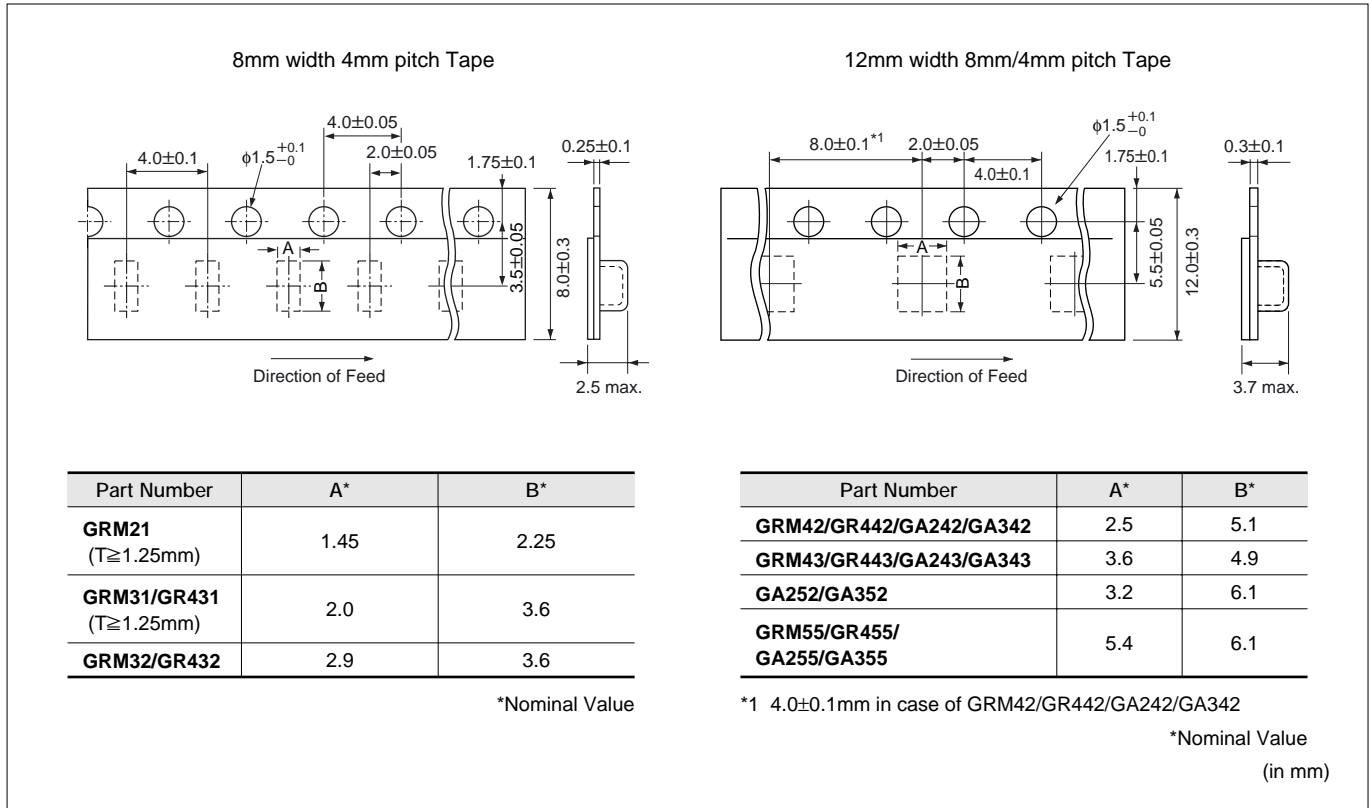

#### ② Paper Tape

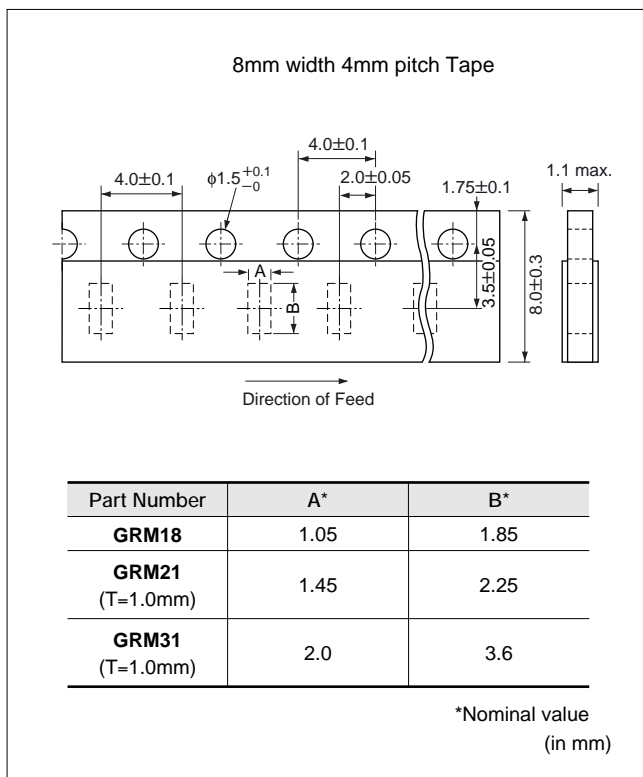

#### (3) Dimensions of Reel

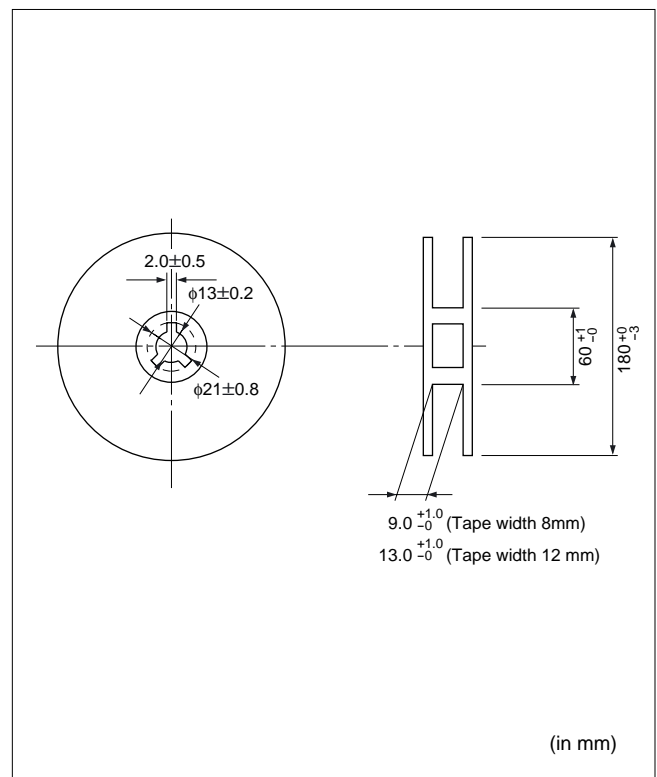

Continued on the following page. ☑

## Package

☐ Continued from the preceding page.

### (4) Taping Method

- ① Tapes for capacitors are wound clockwise. The sprocket holes are to the right as the tape is pulled toward the user.
- ② Part of the leader and part of the empty tape shall be attached to the end of the tape as shown at right.
- ③ The top tape or cover tape and base tape are not attached at the end of the tape for a minimum of 5 pitches.
- ④ Missing capacitors number within 0.1% of the number per reel or 1 pc, whichever is greater, and are not continuous.
- ⑤ The top tape or cover tape and bottom tape shall not protrude beyond the edges of the tape and shall not cover sprocket holes.
- ⑥ Cumulative tolerance of sprocket holes, 10 pitches :  $\pm 0.3\text{mm}$ .
- ⑦ Peeling off force : 0.1 to 0.7N in the direction shown at right.

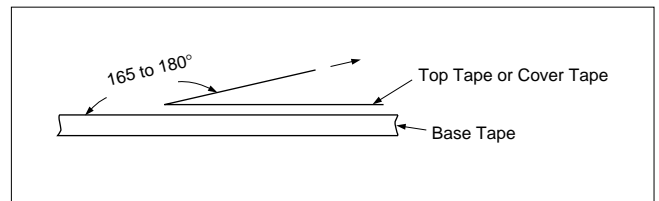
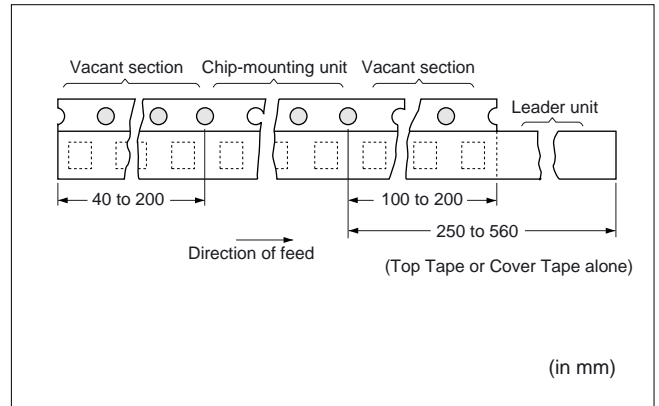





## ■ Storage and Operating Conditions

### Operating and storage environment

Do not use or store capacitors in a corrosive atmosphere, especially where chloride gas, sulfide gas, acid, alkali, salt or the like are present. And avoid exposure to moisture. Before cleaning, bonding or molding this product, verify that these processes do not affect product quality by testing the performance of a cleaned, bonded or molded product in the intended equipment. Store the capacitors

where the temperature and relative humidity do not exceed 5 to 40 degrees centigrade and 20 to 70%.

Use capacitors within 6 months. Check the solderability after 6 months or more.

**FAILURE TO FOLLOW THE ABOVE CAUTIONS MAY RESULT, WORST CASE, IN A SHORT CIRCUIT AND CAUSE FUMING OR PARTIAL DISPERSION WHEN THE PRODUCT IS USED.**

## ■ Handling

### 1. Vibration and impact

Do not expose a capacitor to excessive shock or vibration during use.

### 2. Do not directly touch the chip capacitor, especially the ceramic body. Residue from hands/fingers may create a short circuit environment.

**FAILURE TO FOLLOW THE ABOVE CAUTIONS MAY RESULT, WORST CASE, IN A SHORT CIRCUIT AND CAUSE FUMING OR PARTIAL DISPERSION WHEN THE PRODUCT IS USED.**

## ⚠️ Caution

### ■ Caution (Rating)

#### 1. Operating Voltage

When DC-rated capacitors are to be used in AC or ripple current circuits, be sure to maintain the  $V_{p-p}$  value of the applied voltage or the  $V_{o-p}$  which contains DC bias within the rated voltage range.

When the voltage is applied to the circuit, starting or stopping may generate irregular voltage for a transit period because of resonance or switching. Be sure to use a capacitor with a rated voltage range that includes these irregular voltages.

Voltage	DC Voltage	DC+AC Voltage	AC Voltage	Pulse Voltage (1)	Pulse Voltage (2)
Positional Measurement					

#### 2. Operating Temperature and Self-generated Heat

(1) In case of X7R char. and GA3 series SL char.

Keep the surface temperature of a capacitor below the upper limit of its rated operating temperature range. Be sure to take into account the heat generated by the capacitor itself. When the capacitor is used in a high-frequency current, pulse current or the like, it may have the self-generated heat due to dielectric-loss. Applied voltage should be the load such as self-generated heat is within 20°C on the condition of atmosphere temperature 25°C. When measuring, use a thermocouple of small thermal capacity-K of  $\phi 0.1\text{mm}$  in conditions where the capacitor is not affected by radiant heat from other components or surrounding ambient fluctuations. Excessive heat may lead to deterioration of the capacitor's characteristics and reliability. (Never attempt to perform measurement with the cooling fan running. Otherwise, accurate measurement cannot be ensured.)

(2) In case of COG/R char.

Keep the surface temperature of a capacitor below the upper limit of its rated operating temperature range. Be sure to take into account the heat generated by the capacitor itself. When the capacitor is used in a high-frequency current, pulse current or similar current, it may self-generate heat due to dielectric loss. The frequency of the applied sine wave voltage should be less than 500kHz (less than 100kHz in case of rated voltage: DC3.15kV). The applied voltage should be less than the value shown in figure at right. In case of non-sine wave which include a harmonic frequency, please contact our sales representatives or product engineers. Excessive heat may lead to deterioration of the capacitor's characteristics and reliability. (Never attempt to perform measurement with the cooling fan running. Otherwise, accurate measurement cannot be ensured.)

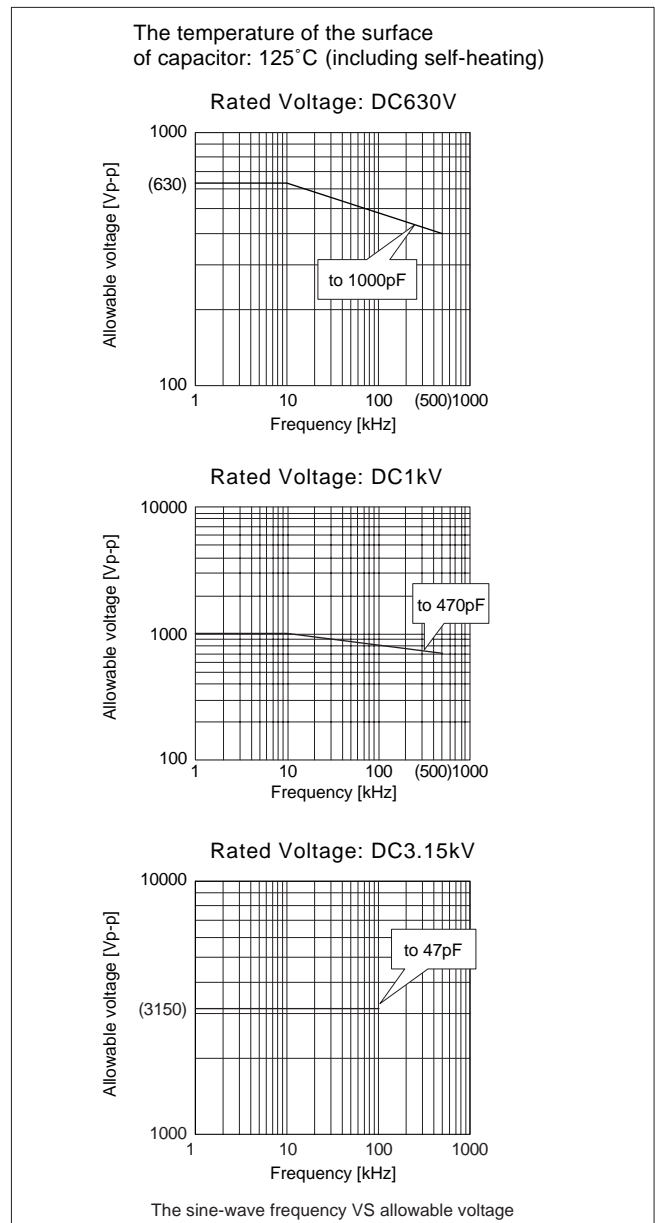

Continued on the following page.

**⚠Caution**

☐ Continued from the preceding page.

(3) In case of GRM series SL char.

Keep the surface temperature of a capacitor below the upper limit of its rated operating temperature range. Be sure to take into account the heat generated by the capacitor itself. When the capacitor is used in a high-frequency current, pulse current or similar current, it may self-generate heat due to dielectric loss. The frequency of the applied sine wave voltage should be less than 500kHz. The applied voltage should be less than the value shown in figure at right. In case of non-sine wave which include a harmonic frequency, please contact our sales representatives or product engineers. Excessive heat may lead to deterioration of the capacitor's characteristics and reliability. (Never attempt to perform measurement with the cooling fan running. Otherwise, accurate measurement cannot be ensured.)

3. Test condition for AC withstanding Voltage

(1) Test Equipment

Tests for AC withstanding voltage should be made with equipment capable of creating a wave similar to a 50/60 Hz sine wave. If the distorted sine wave or overload exceeding the specified voltage value is applied, a defect may be caused.

(2) Voltage applied method

The capacitor's leads or terminals should be firmly connected to the output of the withstanding voltage test equipment, and then the voltage should be raised from near zero to the test voltage. If the test voltage is applied directly to the capacitor without raising it from near zero, it should be applied with the \*zero cross. At the end of the test time, the test voltage should be reduced to near zero, and then the capacitor's leads or terminals should be taken off the output of the withstanding voltage test equipment. If the test voltage is applied directly to the capacitor without raising it from near zero, surge voltage may occur and cause a defect.

\*ZERO CROSS is the point where voltage sine wave pass 0V.

- See the figure at right -

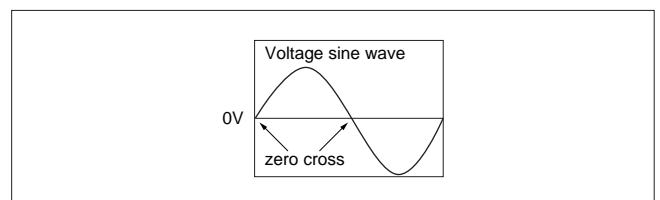
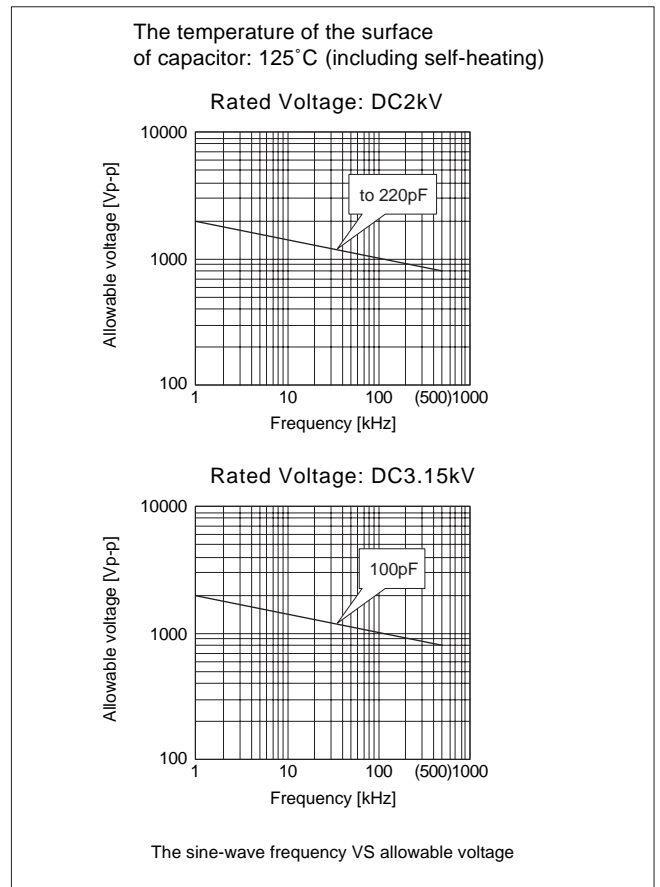

Continued on the following page. ☐

## ⚠Caution

☒ Continued from the preceding page.

### 4. Fail-Safe

Failure of a capacitor may result in a short circuit. Be sure to provide an appropriate fail-safe function such as a fuse on your product to help eliminate possible electric shock, fire, or fumes.

Please consider using fuses on each AC line if the capacitors are used between the AC input lines and earth (line bypass capacitors), to prepare for the worst case, such as a short circuit.

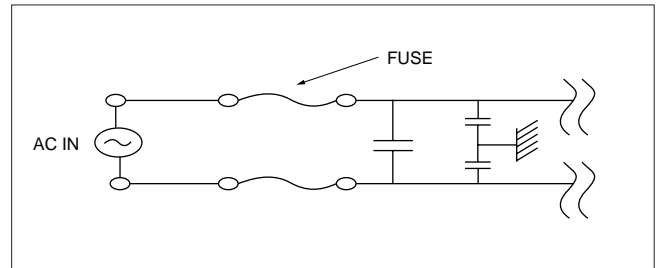

**FAILURE TO FOLLOW THE ABOVE CAUTIONS MAY RESULT, WORST CASE, IN A SHORT CIRCUIT AND CAUSE FUMING OR PARTIAL DISPERSION WHEN THE PRODUCT IS USED.**

**⚠Caution**

**■ Caution (Soldering and Mounting)**

**1. Vibration and Impact**

Do not expose a capacitor to excessive shock or vibration during use.

**2. Circuit Board Material**

In case that chip size is 4.5×3.2mm or more, a metal-board or metal-frame such as Aluminum board is not available because soldering heat causes expansion and shrinkage of a board or frame, which will cause a chip to crack.

**3. Land Layout for Cropping PC Board**

Choose a mounting position that minimizes the stress imposed on the chip during flexing or bending of the board.

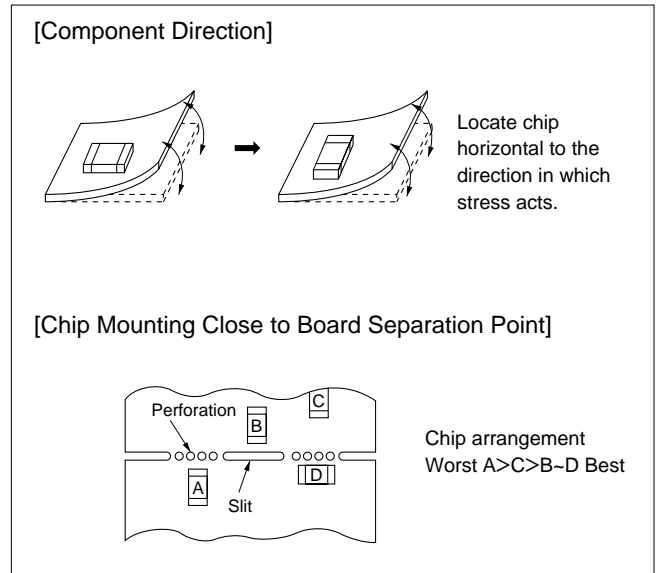

Continued on the following page. ↗

## ⚠ Caution

☐ Continued from the preceding page.

### 4. Soldering (Prevention of the thermal shock)

If a chip component is heated or cooled abruptly during soldering, it may crack due to the thermal shock. To prevent this, follow our recommendations below for adequate soldering conditions.

Carefully perform pre-heating so that temperature difference ( $\Delta T$ ) between the solder and component surface is in the following range. When components are immersed in solvent after mounting, pay special attention to keep the temperature difference within 100°C.

Chip Size	3.2×1.6mm and under	3.2×2.5mm and over
Soldering Method		
Reflow Method or Soldering Iron Method	$\Delta T \leq 190^\circ\text{C}$	$\Delta T \leq 130^\circ\text{C}$
Flow Method or Dip Soldering Method	$\Delta T \leq 150^\circ\text{C}$	—

When correcting chips with a soldering iron, no preheating is required if the chip is listed in following table and the following conditions are met. Preheating should be performed on chips not listed in following table.

Item	Conditions	
Chip Size	$\leq 2.0 \times 1.25\text{mm}$	3.2×1.6mm
Temperature of Iron tip	300°C max.	270°C max.
Soldering Iron Wattage	20W max.	
Diameter of Iron tip	$\phi$ 3.0mm max.	
Soldering Time	3 sec. max.	
Caution	Do not allow the iron tip to directly touch the ceramic element.	

Infrared Reflow Soldering Conditions (Example)

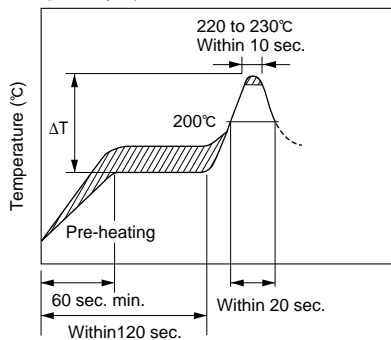

Vapor Reflow Soldering (VPS) Conditions (Example)

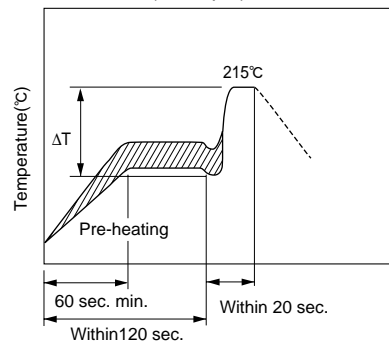

Flow Soldering Conditions (Example)

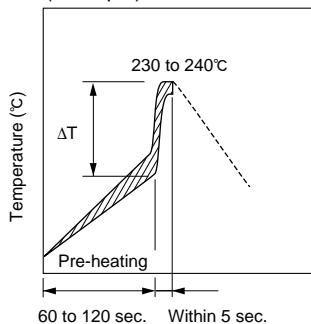

Dip Soldering/Soldering Iron Conditions (Example)

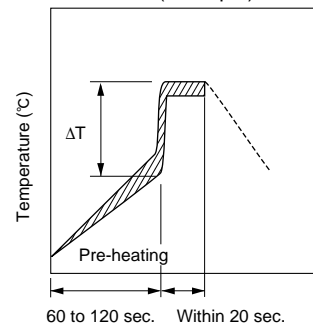

### 5. Soldering Method

GR/GA products whose sizes are 3.2×1.6mm and under for flow and reflow soldering, and other sizes for reflow soldering.

Be sure to contact our sales representatives or engineers in case that GR/GA products (size 3.2×2.5mm and over) are to be mounted with flow soldering. It may crack due to the thermal shock.

FAILURE TO FOLLOW THE ABOVE CAUTIONS MAY RESULT, WORST CASE, IN A SHORT CIRCUIT AND FUMING WHEN THE PRODUCT IS USED.

## Notice

### ■ Notice (Soldering and Mounting)

#### 1. Mounting of Chips

##### ● Mechanical shock of the chip placer

When the positioning claws and pick-up nozzle are worn, the load is applied to the chip while positioning is concentrated in one position, thus causing cracks, breakage, faulty positioning accuracy, etc. Careful checking and maintenance are necessary to prevent unexpected trouble.

An excessively low bottom dead point of the suction nozzle imposes great force on the chip during mounting, causing cracked chips. Please set the suction nozzle's bottom dead point on the upper surface of the board.

#### 2. Construction of Board Pattern

After installing chips, if solder is excessively applied to the circuit board, mechanical stress will cause destruction resistance characteristics to lower. To prevent this, be extremely careful in determining shape and dimension before designing the circuit board diagram.

#### Termination Thickness of Chip Capacitor and Desirable Thickness of Adhesives Applied

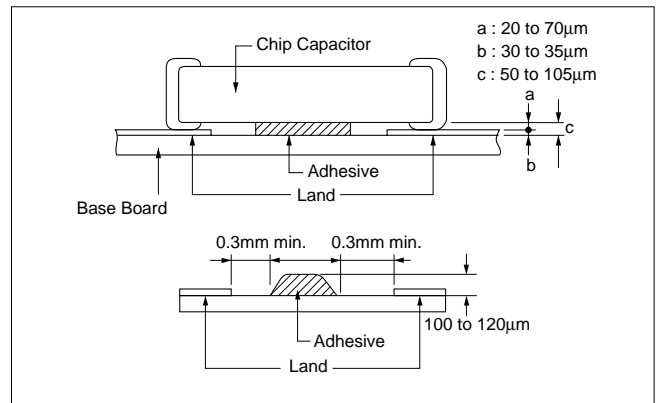

#### Construction and Dimensions of Pattern (Example)

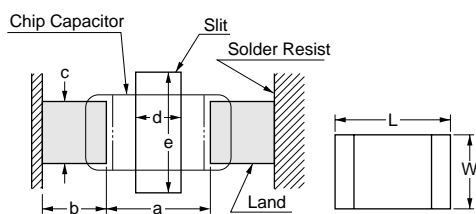

Preparing slit helps flux cleaning and resin coating on the back of the capacitor.

#### Flow Soldering

L×W	a	b	c
1.6×0.8	0.6-1.0	0.8-0.9	0.6-0.8
2.0×1.25	1.0-1.2	0.9-1.0	0.8-1.1
3.2×1.6	2.2-2.6	1.0-1.1	1.0-1.4

#### Reflow Soldering

L×W	a	b	c	d	e
1.6×0.8	0.6-0.8	0.6-0.7	0.6-0.8	-	-
2.0×1.25	1.0-1.2	0.9-1.0	0.8-1.1	-	-
3.2×1.6	2.2-2.4	0.8-0.9	1.0-1.4	1.0-2.0	3.2-3.7
3.2×2.5	2.0-2.4	1.0-1.2	1.8-2.3	1.0-2.0	4.1-4.6
4.5×2.0	2.8-3.4	1.2-1.4	1.4-1.8	1.0-2.8	3.6-4.1
4.5×3.2	2.8-3.4	1.2-1.4	2.3-3.0	1.0-2.8	4.8-5.3
5.7×2.8	4.0-4.6	1.4-1.6	2.1-2.6	1.0-4.0	4.4-4.9
5.7×5.0	4.0-4.6	1.4-1.6	3.5-4.8	1.0-4.0	6.6-7.1

(in mm)

Continued on the following page.

## Notice

☑ Continued from the preceding page.

### Land Layout to Prevent Excessive Solder

	Mounting Close to a Chassis	Mounting with Leaded Components	Mounting Leaded Components Later
Examples of Arrangements to be Avoided			
Examples of Improvements by the Land Division			

## 3. Soldering

### (1) Care for minimizing loss of the terminations.

The information below illustrates the soldering conditions needed to minimize the loss of the effective area on the terminations.

Depending on the conditions of the soldering temperature and/or immersion (melting time), effective areas may be lost in some part of the terminations.

To prevent this, be careful in soldering so that any possible loss of the effective area on the terminations will securely remain at a maximum of 25% on all edge length A-B-C-D-A of part with A, B, C, D, shown in the Figure below.

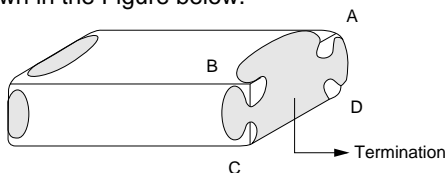

Soldering Allowance Time

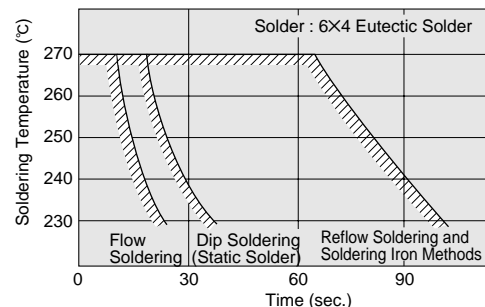

In case of repeated soldering, the accumulated soldering time must be within the range shown above.

### (2) Flux

- Use rosin-type flux and do not use a highly acidic flux (any containing a minimum of 0.2wt% chlorine).

### (3) Solder Buildup

#### ① Flow soldering and iron soldering

When soldering, use less than the maximum and more than the minimum solder buildup as shown in the illustration to the right.

During the soldering process, insure that the solder is securely placed.

[Solder Buildup by Flow Method and Soldering Iron Method]

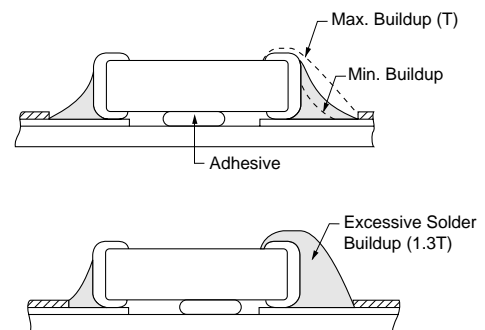

Continued on the following page. ☑



## Notice

☐ Continued from the preceding page.

### ② Reflow soldering

When soldering, confirm that the solder is placed over 0.2mm of the surface of the terminations.

[Solder Buildup by Reflow Method]

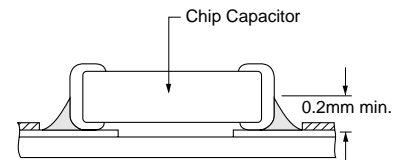

## 4. Cleaning

To perform ultrasonic cleaning, observe the following conditions.

Rinse bath capacity : Output of 20 watts per liter or less.

Rinsing time : 5 min maximum.

Do not vibrate the PWBs.

## 5. Resin Coating

- When selecting resin materials, select those with low contraction and low moisture absorption coefficient (generally epoxy resin is used).
- Buffer coat can decrease the influence of the resin shrinking (generally silicone resin).

## Notice

### ■ Rating

#### Capacitance change of capacitor

##### 1. In case of X7R char.

Capacitors have an aging characteristic, whereby the capacitor continually decreases its capacitance slightly if the capacitor is left on for a long time. Moreover, capacitance might change greatly depending on the surrounding temperature or an applied voltage. So, it is not likely to be

suitable for use in a time constant circuit.

Please contact us if you need detailed information.

##### 2. In case of C0G/R/SL char.

Capacitance might change a little depending on the surrounding temperature or an applied voltage.

Please contact us if you intend to use this product in a strict time constant circuit.

## ISO 9000 Certifications

Plant	Certified Date	Organization	Registration No.
Fukui Murata Manufacturing Co., Ltd.	Apr. 2, '97	UL *1 ISO9001	A5287
Izumo Murata Manufacturing Co., Ltd.	Jul. 25, '97		A5587
Murata Electronics Singapore (Pte.) Ltd.	Nov. 3, '99	PSB *2 ISO9001	99-2-1085
Murata Manufacturing (UK) Ltd.	Jun. 24, '98	BSI *3 ISO9001	FM 22169
Murata Amazonia Industria Comercio Ltda.	Jul. 28, '98	FUNDACAO VANZOLINI ISO9002	SQ-480-675/98
Murata Electronics North America State College Plant	Mar. 7, '96	UL *1 ISO9001	A1734
Beijing Murata Electronics Co., Ltd.	Dec. 10, '98	UL *1 ISO9002	A7123

\*1 UL : Underwriters Laboratories Inc.

\*2 PSB : Singapore Productivity and Standards Board

\*3 BSI : British Standards Institution

**⚠Note:**

1. Export Control

⟨For customers outside Japan⟩

Murata products should not be used or sold for use in the development, production, stockpiling or utilization of any conventional weapons or mass-destructive weapons (nuclear weapons, chemical or biological weapons, or missiles), or any other weapons.

⟨For customers in Japan⟩

For products which are controlled items subject to the "Foreign Exchange and Foreign Trade Law" of Japan, the export license specified by the law is required for export.

2. Please contact our sales representatives or product engineers before using the products in this catalog for the applications listed below, which require especially high reliability for the prevention of defects which might directly damage to a third party's life, body or property, or when one of our products is intended for use in applications other than those specified in this catalog.

- |                             |   |
|-----------------------------|---|
| ① Aircraft equipment        | ② Aerospace equipment   |
| ③ Undersea equipment        | ④ Power plant equipment   |
| ⑤ Medical equipment         | ⑥ Transportation equipment (vehicles, trains, ships, etc.)  |
| ⑦ Traffic signal equipment  | ⑧ Disaster prevention / crime prevention equipment  |
| ⑨ Data-processing equipment | ⑩ Application of similar complexity and/or reliability requirements to the applications listed in the above |

3. Product specifications in this catalog are as of August 2003. They are subject to change or our products in it may be discontinued without advance notice. Please check with our sales representatives or product engineers before ordering. If there are any questions, please contact our sales representatives or product engineers.

4. Please read rating and ⚠CAUTION (for storage, operating, rating, soldering, mounting and handling) in this catalog to prevent smoking and/or burning, etc.

5. This catalog has only typical specifications because there is no space for detailed specifications. Therefore, please approve our product specifications or transact the approval sheet for product specifications before ordering.

6. Please note that unless otherwise specified, we shall assume no responsibility whatsoever for any conflict or dispute that may occur in connection with the effect of our and/or a third party's intellectual property rights and other related rights in consideration of your use of our products and/or information described or contained in our catalogs. In this connection, no representation shall be made to the effect that any third parties are authorized to use the rights mentioned above under licenses without our consent.

7. No ozone depleting substances (ODS) under the Montreal Protocol are used in our manufacturing process.