

### Typical Applications

The HMC194MS8 is ideal for:

- Cellular/PCS Base Stations
- Portable Wireless
- MMDS & WirelessLAN

### Features

- Ultra Small Package: MSOP8
- High Isolation: 50 dB
- Positive Control: 0/+3V to 0/+7V

### Functional Diagram

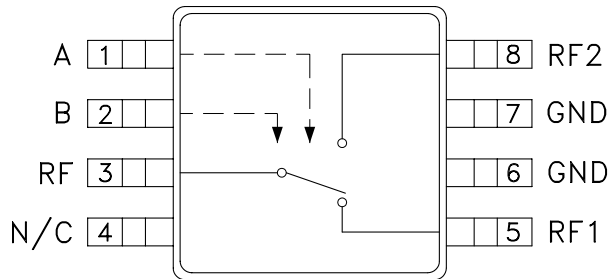

### General Description

The HMC194MS8 is a low-cost SPDT switch in an 8-lead MSOP package for use in applications which require high isolation between two RF paths. The device can control signals from DC to 3 GHz and has been optimized to provide extremely high isolation with minimal insertion loss in medium and low power applications. On chip circuitry allows positive voltage control operation at very low DC currents with control inputs compatible with CMOS and most TTL logic families. RF1 and RF2 are reflective opens when "OFF".

### Electrical Specifications, $T_A = +25^\circ C$ , $V_{ctl} = 0/+5 V_{dc}$ , 50 Ohm System

Parameter	Frequency	Min.	Typ.	Max.	Units
Insertion Loss	DC - 1.0 GHz		0.7	0.9	dB
	DC - 2.0 GHz		0.7	0.9	dB
	DC - 2.5 GHz		0.8	1.1	dB
	DC - 3.0 GHz		0.9	1.4	dB
Isolation	RF1 / RF2	DC - 1.0 GHz	45 / 47	49 / 51	dB
	RF1 / RF2	DC - 2.0 GHz	39 / 43	42 / 46	dB
		DC - 2.5 GHz	31	35	dB
		DC - 3.0 GHz	24	28	dB
Return Loss	DC - 1.0 GHz	18	21		dB
	DC - 2.0 GHz	14	17		dB
	DC - 2.5 GHz	13	17		dB
	DC - 3.0 GHz	13	17		dB
Input Power for 1 dB Compression 0/+5V Control	0.5 - 1.0 GHz	19	23		dBm
	0.5 - 3.0 GHz	17	21		dBm
Input Third Order Intercept (Two-tone Input Power = +7 dBm Each Tone) 0/+5V Control	0.5 - 1.0 GHz	39	43		dBm
	0.5 - 3.0 GHz	37	41		dBm
Switching Characteristics	DC - 3.0 GHz				
		tRISE, tFALL (10/90% RF) tON , tOFF (50% CTL to 10/90% RF)		10 24	ns ns

### Insertion Loss

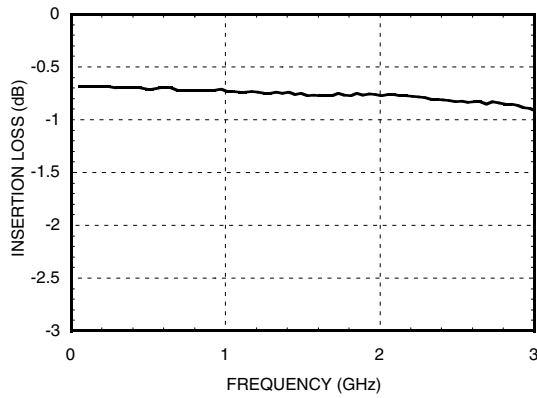

### Isolation

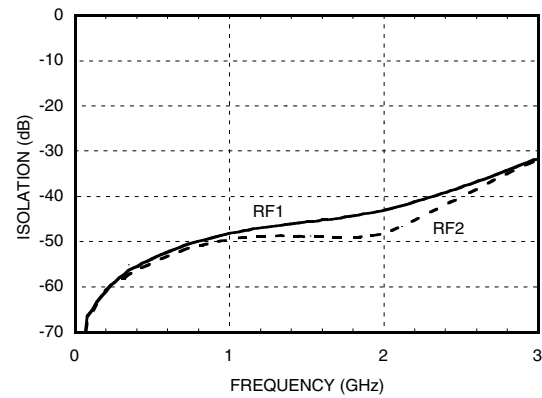

### Return Loss

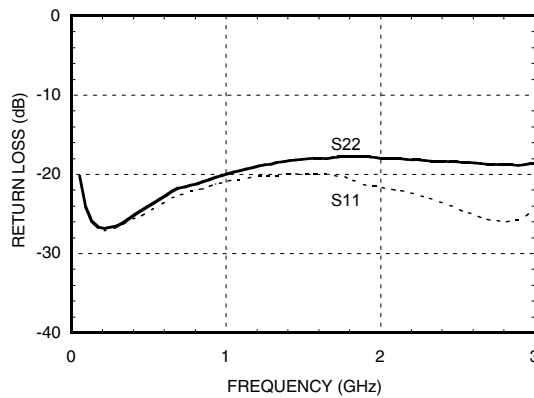

### Input 0.1 and 1.0 dB Compression vs. Control Voltage

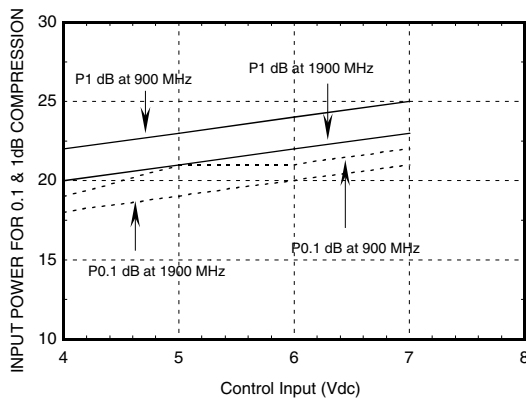

### Input Third Order Intercept Point vs. Control Voltage

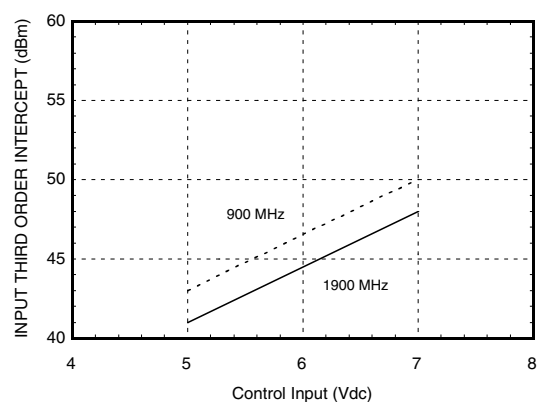

### Compression vs. Control Voltage

Bias Vdd	Carrier at 900 MHz		Carrier at 1900 MHz	
	Input Power for 0.1 dB Compression	Input Power for 1.0 dB Compression	Input Power for 0.1 dB Compression	Input Power for 1.0 dB Compression
(Vdc)	(dBm)	(dBm)	(dBm)	(dBm)
+4	19	22	18	20
+5	21	23	19	21
+6	21	24	20	22
+7	22	25	21	23

Caution: Do not operate in 1dB compression at power levels above +25 dBm and do not "hot switch" power levels greater than +18 dBm (Control = 0/+5Vdc).

DC blocks are required at ports RFC, RF1 and RF2.

### Distortion vs. Control Voltage

Control Input	Third Order Intercept (dBm) +7 dBm Each Tone	
	900 MHz	1900 MHz
(Vdc)		
+5	43	41
+7	50	48

### Truth Table

\*Control Input Voltage Tolerances are  $\pm 0.2$  Vdc.

Control Input*		Control Current		Signal Path State	
A (Vdc)	B (Vdc)	Ia (uA)	Ib (uA)	RF to RF1	RF to RF2
0	+3	-23	+23	ON	OFF
+3	0	+23	-23	OFF	ON
0	+5	-95	+95	ON	OFF
+5	0	+95	-95	OFF	ON
0	+7	-190	+190	ON	OFF
+7	0	+190	-190	OFF	ON

### Absolute Maximum Ratings

Control Voltage Range (A & B)	-0.2 to +7.5 Vdc
Storage Temperature	-65 to +150 °C
Operating Temperature	-40 to +85 °C

### Outline Drawing

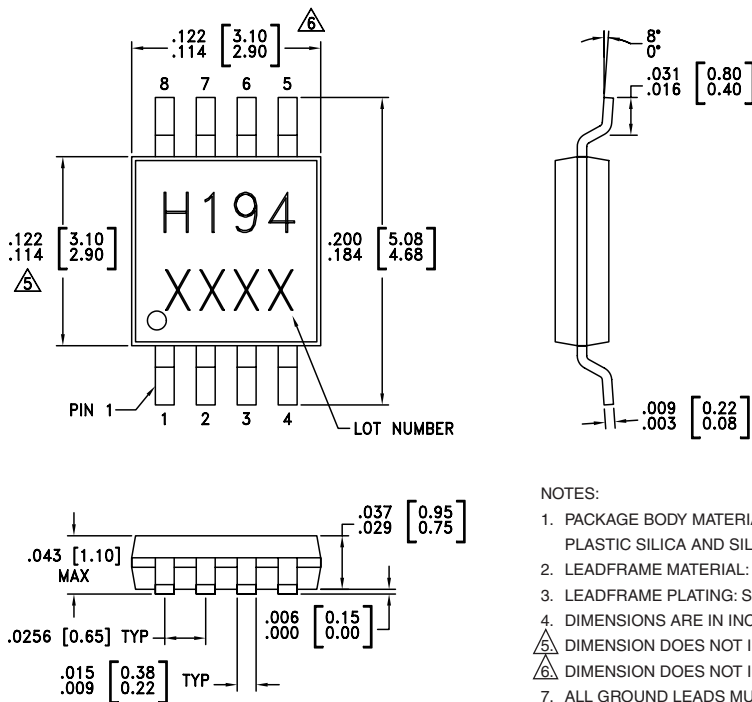

### Typical Application Circuit

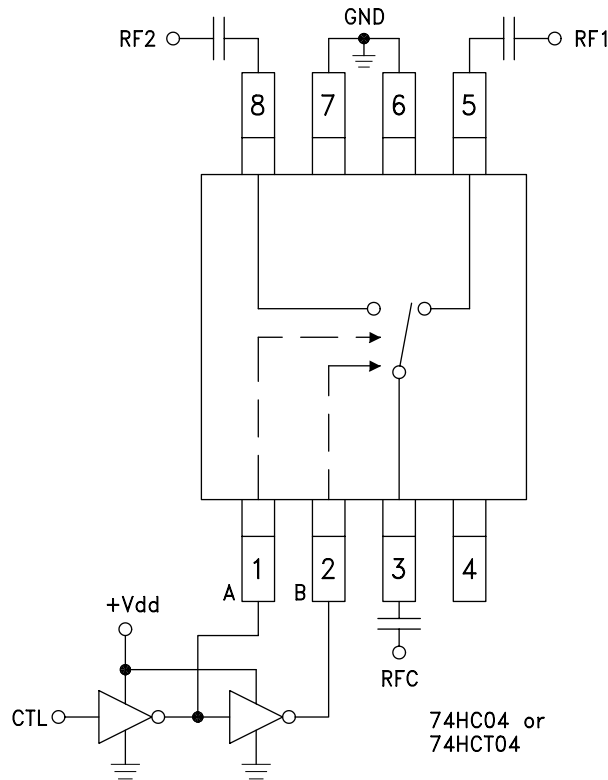

**Notes:**

1. Set logic gate and switch Vdd = +3V to +5V and use HCT series logic to provide a TTL driver interface.
2. Control inputs A/B can be driven directly with CMOS logic (HC) with Vdd of 3 to 7 Volts applied to the CMOS logic gates.
3. DC Blocking capacitors are required for each RF port as shown. Capacitor value determines lowest frequency of operation.
4. Highest RF signal power capability is achieved with Control set to 0/+7V.

**See “Design Techniques Enhance Isolation in Switch Assemblies”  
for HMC194MS8 Applications, “Application Notes” Section.**

### Evaluation Circuit Board

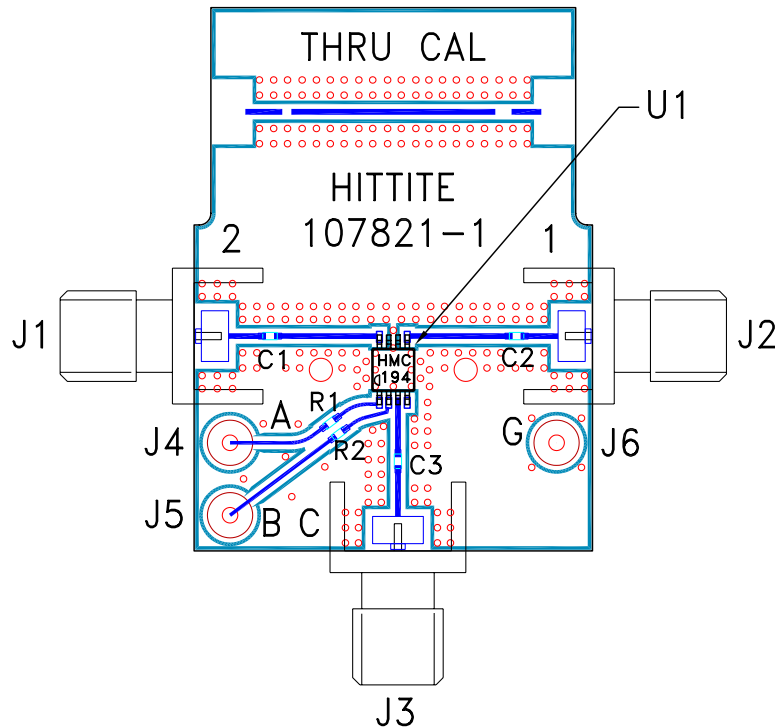

### List of Material

Item	Description
J1 - J3	PC Mount SMA RF Connector
J4 - J6	DC Pin
C1 - C3	100 pF capacitor, 0402 Pkg.
R1, R2	100 $\Omega$ resistor, 0402 Pkg.
U1	HMC194MS8 SPDT Switch
PCB*	107821 Evaluation PCB
* Circuit Board Material: Rogers 4350	

The circuit board used in the final application should be generated with proper RF circuit design techniques. Signal lines at the RF port should have 50 ohm impedance and the package ground leads should be connected directly to the ground plane similar to that shown above. The evaluation circuit board shown above is available from Hittite Microwave Corporation upon request.