

Low Noise, Cascadable Silicon Bipolar MMIC Amplifier

Technical Data

INA-02184
INA-02186

Features

- **Cascadable 50 Ω Gain Block**
- **Low Noise Figure:**
2.0 dB Typical at 0.5 GHz
- **High Gain:**
31 dB Typical at 0.5 GHz
26 dB Typical at 1.5 GHz
- **3 dB Bandwidth:**
DC to 0.8 GHz
- **Unconditionally Stable**
($k > 1$)
- **Low Cost Plastic Package**

Description

The INA-02184 and INA-02186 are low-noise silicon bipolar Monolithic Microwave Integrated

Circuit (MMIC) feedback amplifiers housed in low cost plastic packages. They are designed for narrow or wide bandwidth commercial applications that require high gain and low noise IF or RF amplification.

The INA series of MMICs is fabricated using HP's 10 GHz f_T , 25 GHz f_{MAX} , ISOSAT™-I silicon bipolar process which uses nitride self-alignment, submicrometer lithography, trench isolation, ion implantation, gold metallization and polyimide intermetal dielectric and scratch protection to achieve excellent performance, uniformity and reliability.

Package 84

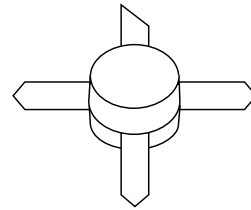

Package 86

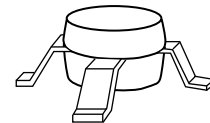

Typical Biasing Configuration

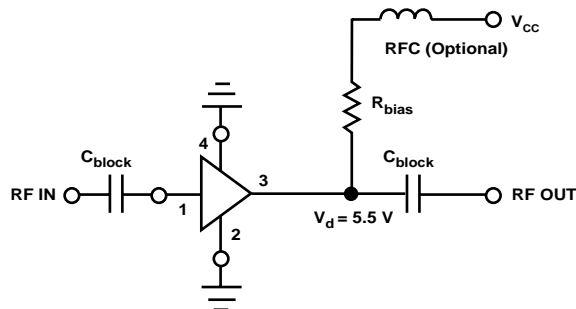

INA-02184, -02186 Absolute Maximum Ratings

Parameter	Absolute Maximum ^[1]
Device Current	50 mA
Power Dissipation ^[2,3,4]	400 mW
RF Input Power	+13 dBm
Junction Temperature	+150°C
Storage Temperature	-65 to 150°C

Thermal Resistance^{[2]:}

$$\theta_{jc} = 90^{\circ}\text{C/W} \text{ — INA-02184}$$

$$\theta_{jc} = 100^{\circ}\text{C/W} \text{ — INA-02186}$$

Notes:

1. Permanent damage may occur if any of these limits are exceeded.
2. $T_{\text{CASE}} = 25^{\circ}\text{C}$.
3. Derate at 11.1 mW/°C for $T_{\text{C}} > 144^{\circ}\text{C}$ for INA-02184.
4. Derate at 10 mW/°C for $T_{\text{C}} > 110^{\circ}\text{C}$ for INA-02186.

INA-02184, -02186 Electrical Specifications^[1], $T_{\text{A}} = 25^{\circ}\text{C}$

Symbol	Parameters and Test Conditions: $I_{\text{d}} = 35 \text{ mA}$, $Z_{\text{o}} = 50 \Omega$	Units	INA-02184			INA-02186			
			Min.	Typ.	Max.	Min.	Typ.	Max.	
G_{P}	Power Gain ($ S_{21} ^2$)	$f = 0.5 \text{ GHz}$	dB	29.0	31.0		29.0	31.0	
ΔG_{P}	Gain Flatness	$f = 0.01 \text{ to } 1.0 \text{ GHz}$	dB		± 2.0			± 2.0	
f_3 dB	3 dB Bandwidth ^[2]		GHz		0.8			0.8	
ISO	Reverse Isolation ($ S_{12} ^2$)	$f = 0.01 \text{ to } 1.0 \text{ GHz}$	dB		39			39	
VSWR	Input VSWR (Max over Freq. Range)	$f = 0.01 \text{ to } 1.0 \text{ GHz}$			1.5			2.0	
	Output VSWR (Max over Freq. Range)	$f = 0.01 \text{ to } 1.0 \text{ GHz}$			1.7			1.7	
NF	50 Ω Noise Figure	$f = 0.5 \text{ GHz}$	dB		2.0			2.0	
P_1 dB	Output Power at 1 dB Gain Compression	$f = 0.5 \text{ GHz}$	dBm		11			11	
IP_3	Third Order Intercept Point	$f = 0.5 \text{ GHz}$	dBm		23			23	
t_{D}	Group Delay	$f = 0.5 \text{ GHz}$	psec		330			350	
V_{d}	Device Voltage		V	4.0	5.5	7.0	4.0	5.5	7.0
dV/dT	Device Voltage Temperature Coefficient		mV/°C		+10			+10	

Notes:

1. The recommended operating current range for this device is 30 to 40 mA. Typical performance as a function of current is on the following page.
2. Referenced from 10 MHz Gain (G_{P}).

INA-02184, -02186 Part Number Ordering Information

Part Number	No. of Devices	Container
INA-02184-TR1	1000	7" Reel
INA-02184-BLK	100	Antistatic Bag
INA-02186-TR1	1000	7" Reel
INA-02186-BLK	100	Antistatic Bag

For more information, see "Tape and Reel Packaging for Semiconductor Devices".

INA-02184, -02186 Typical Performance, $T_A = 25^\circ\text{C}$
(unless otherwise noted)

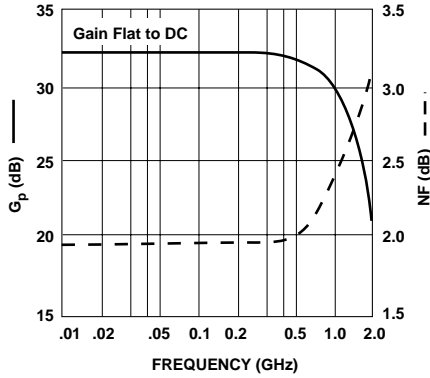

Figure 1. Typical Gain and Noise Figure vs. Frequency, $T_A = 25^\circ\text{C}$, $I_d = 35\text{ mA}$.

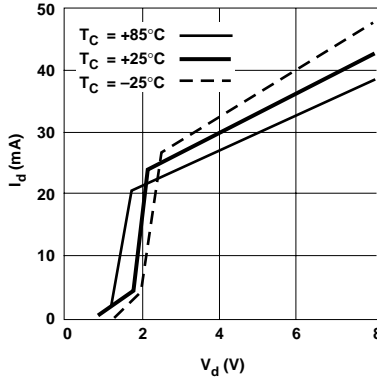

Figure 2. Device Current vs. Voltage.

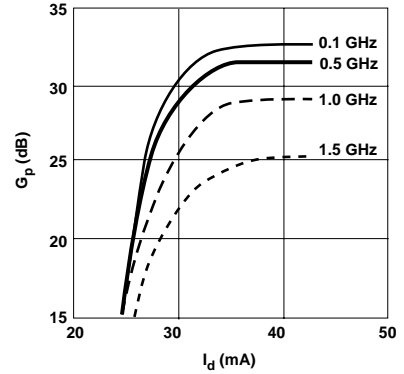

Figure 3. Power Gain vs. Current.

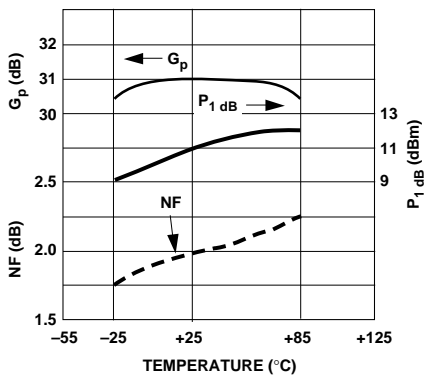

Figure 4. Output Power and 1 dB Gain Compression, NF and Power Gain vs. Case Temperature, $f = 0.5\text{ GHz}$, $I_d = 35\text{ mA}$.

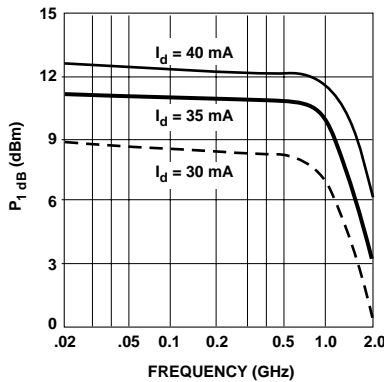

Figure 5. Output Power at 1 dB Gain Compression vs. Frequency.

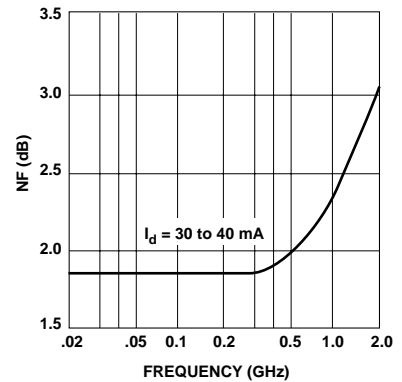

Figure 6. Noise Figure vs. Frequency.

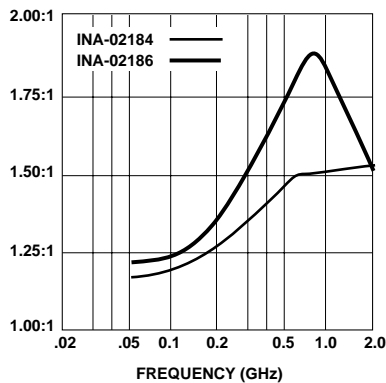

Figure 7. Input VSWR vs. Frequency, $I_d = 35\text{ mA}$.

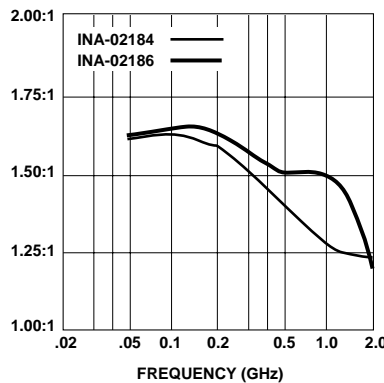

Figure 8. Output VSWR vs. Frequency, $I_d = 35\text{ mA}$.

Typical INA-02184 Scattering Parameters ($Z_o = 50 \Omega$, $T_A = 25^\circ\text{C}$, $I_d = 35 \text{ mA}$)

Freq. GHz	S ₁₁		S ₂₁			S ₁₂			S ₂₂		k
	Mag	Ang	dB	Mag	Ang	dB	Mag	Ang	Mag	Ang	
0.01	.09	-176	31.9	39.33	-1	-40.0	.010	1	.25	-1	1.40
0.05	.09	-171	31.9	39.24	-6	-41.9	.008	-12	.25	-4	1.66
0.10	.10	-163	31.8	39.07	-13	-40.9	.009	1	.25	-8	1.52
0.20	.13	-159	31.7	38.30	-26	-40.0	.010	15	.23	-13	1.44
0.30	.15	-161	31.4	37.30	-39	-38.4	.012	16	.22	-17	1.29
0.40	.18	-168	31.2	36.42	-51	-39.2	.011	32	.21	-15	1.39
0.50	.19	-175	31.0	35.40	-63	-40.0	.010	34	.21	-16	1.52
0.60	.20	179	30.7	34.20	-75	-37.1	.014	35	.21	-17	1.24
0.80	.19	166	29.9	31.21	-101	-38.4	.012	38	.24	-26	1.44
1.00	.17	159	28.4	26.36	-126	-36.5	.015	53	.24	-41	1.40
1.20	.15	159	26.8	21.89	-149	-34.0	.020	56	.22	-60	1.31
1.40	.15	163	24.8	17.36	-169	-33.2	.022	62	.18	-78	1.50
1.60	.16	168	22.6	13.59	175	-31.4	.027	67	.14	-93	1.50
1.80	.18	168	20.7	10.86	161	-31.1	.028	61	.11	-108	1.74
2.00	.19	165	18.8	8.71	149	-30.2	.031	64	.08	-125	1.92
2.50	.23	159	14.9	5.56	127	-29.1	.035	56	.05	-167	2.54
3.00	.27	150	11.5	3.76	106	-27.1	.044	65	.04	156	2.89
3.50	.30	143	8.8	2.74	89	-26.0	.050	57	.04	137	3.39
4.00	.33	133	6.6	2.14	73	-25.0	.056	62	.05	137	3.78

Typical INA-02186 Scattering Parameters ($Z_o = 50 \Omega$, $T_A = 25^\circ\text{C}$, $I_d = 35 \text{ mA}$)

Freq. GHz	S ₁₁		S ₂₁			S ₁₂			S ₂₂		k
	Mag	Ang	dB	Mag	Ang	dB	Mag	Ang	Mag	Ang	
0.01	.09	-178	31.5	37.38	-1	-40.0	.010	1	.24	-1	1.46
0.05	.09	-172	31.5	37.55	-6	-37.7	.013	11	.24	-5	1.22
0.10	.11	-160	31.5	37.46	-13	-39.2	.011	8	.23	-9	1.37
0.20	.14	-153	31.4	37.04	-25	-40.9	.009	15	.22	-17	1.60
0.30	.18	-156	31.3	36.62	-37	-38.4	.012	1	.21	-25	1.30
0.40	.22	-161	31.2	36.20	-49	-37.7	.013	28	.19	-30	1.25
0.50	.25	-169	31.1	35.70	-61	-39.2	.011	42	.18	-35	1.40
0.60	.28	-177	30.9	34.94	-74	-38.4	.012	44	.16	-39	1.33
0.80	.31	165	30.2	32.34	-101	-36.5	.015	52	.15	-47	1.20
1.00	.30	148	28.8	27.64	-129	-34.4	.019	57	.12	-59	1.15
1.20	.27	135	27.0	22.26	-153	-32.4	.024	62	.09	-70	1.15
1.40	.24	129	24.7	17.22	-173	-31.1	.028	61	.07	-80	1.23
1.60	.21	128	22.5	13.27	170	-31.4	.027	62	.04	-82	1.52
1.80	.20	129	20.4	10.42	156	-29.1	.035	61	.02	-83	1.50
2.00	.20	131	18.4	8.34	144	-29.1	.035	63	.01	-20	1.79
2.50	.23	133	14.5	5.29	123	-27.1	.044	59	.02	30	2.15
3.00	.27	130	11.2	3.61	103	-25.7	.052	63	.02	27	2.56
3.50	.31	124	8.3	2.60	86	-24.4	.060	64	.02	34	2.97
4.00	.34	118	6.1	2.02	70	-23.4	.068	58	.01	30	3.28

Emitter Inductance and Performance

As a direct result of their circuit topology, the performance of INA MMICs is extremely sensitive to groundpath (“emitter”) inductance. The two stage design creates the possibility of a feedback loop being formed through the ground returns of the stages. If the path to ground provided by the external circuit is “long” (high in impedance) compared to the path back through the ground return of the other stage, then instability can occur (see Fig. 1). This phenomena can show up as a “peaking” in the gain versus frequency response (perhaps creating a negative gain slope amplifier), an increase in input VSWR, or even as return gain (a

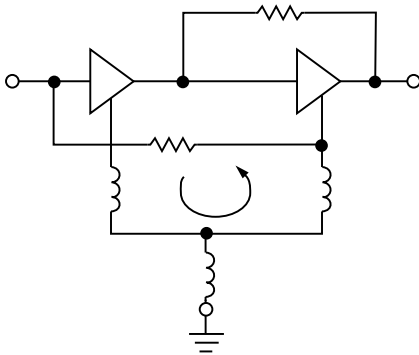

Figure 1. INA Potential Ground Loop.

reflection coefficient greater than unity) at the input of the MMIC.

The “bottomline” is that **excellent grounding is critical** when using INA MMICs. The use of plated through holes or equivalent minimal path ground returns **at the device** is essential. An appropriate layout is shown in Figure 2. A corollary is that designs should be done on the thinnest practical substrate. The parasitic inductance of a pair of via holes passing through 0.032" thick P.C. board is approximately 0.1 nH, while that of a pair of via holes passing through 0.062" thick board is close to 0.5 nH. HP does not recommend using INA family MMICs on boards thicker than 32 mils.

These stability effects are entirely predictable. A circuit simulation using the data sheet S-parameters and including a description of the ground return path (via model or equivalent “emitter” inductance) will give an accurate picture of the performance that can be expected. Device characterizations are made with the ground leads of the MMIC directly contacting a solid copper block (system ground) at a distance of 2 to 4 mils from the body of the package. Thus the information in the data sheet is a true description of the performance capability of the MMIC, and contains minimal contributions from fixturing.

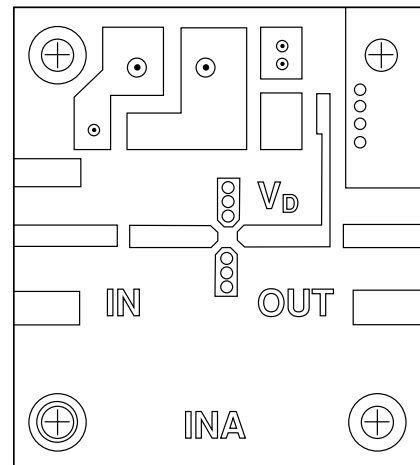
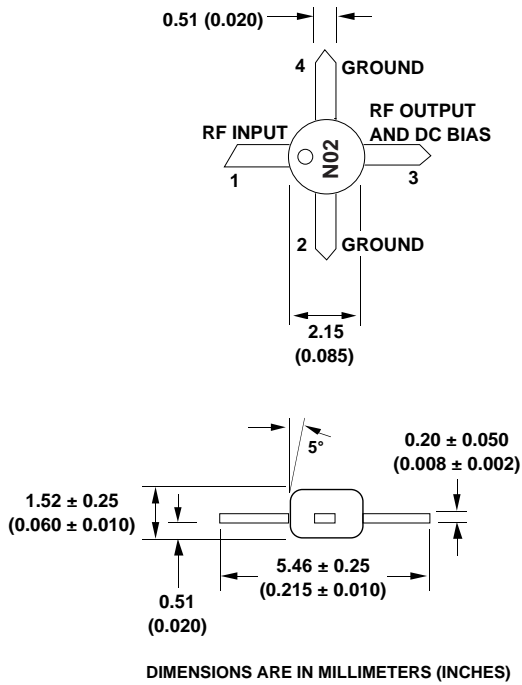

Figure 2. INA Circuit Board 2x Actual Size.

Package 84 Dimensions



Package 86 Dimensions

