

The RF Line  
**Cellular Band**  
**RF Linear LDMOS Amplifier**

**MHL9838**

**800–925 MHz**  
**8.0 W, 31 dB**  
**RF LINEAR LDMOS AMPLIFIER**

Designed for ultra-linear amplifier applications in 50 ohm systems operating in the cellular frequency band. A silicon FET Class A design provides outstanding linearity and gain. In addition, the excellent group delay and phase linearity characteristics are ideal for the most demanding analog or digital modulation systems, such as TDMA and CDMA.

- Third Order Intercept: 50 dBm Typ
- Power Gain: 31 dB Typ (@ f = 880 MHz)
- Excellent Phase Linearity and Group Delay Characteristics
- Ideal for Feedforward Base Station Applications
- For Use in TDMA and CDMA Multi-Carrier Applications

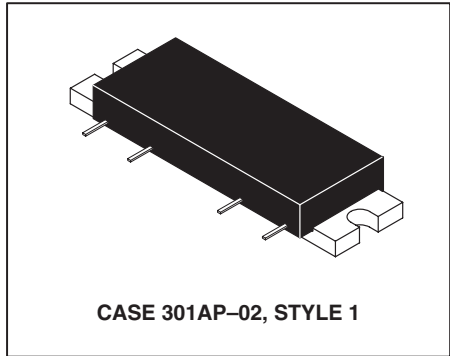

**ABSOLUTE MAXIMUM RATINGS** ( $T_C = 25^\circ\text{C}$  unless otherwise noted)

Rating	Symbol	Value	Unit
DC Supply Voltage	$V_{DD}$	30	Vdc
RF Input Power	$P_{in}$	+6	dBm
Storage Temperature Range	$T_{stg}$	-40 to +100	$^\circ\text{C}$
Operating Case Temperature Range	$T_C$	-20 to +100	$^\circ\text{C}$

**ELECTRICAL CHARACTERISTICS** ( $V_{DD} = 28 \text{ Vdc}$ ,  $T_C = 25^\circ\text{C}$ ; 50  $\Omega$  System)

Characteristic	Symbol	Min	Typ	Max	Unit
Supply Current	$I_{DD}$	—	770	800	mA
Power Gain (f = 880 MHz)	$G_p$	30	31	32	dB
Gain Flatness (f = 800–925 MHz)	$G_F$	—	0.1	0.3	dB
Power Output @ 1 dB Comp. (f = 880 MHz)	$P_{out \ 1 \text{ dB}}$	—	39	—	dBm
Input VSWR (f = 800–925 MHz)	$VSWR_{in}$	—	1.2:1	1.5:1	
Output VSWR (f = 800–925 MHz)	$VSWR_{out}$	—	1.2:1	1.5:1	
Third Order Intercept (f1 = 879 MHz, f2 = 884 MHz)	ITO	49	50	—	dBm
Noise Figure (f = 925 MHz)	NF	—	3.7	4.5	dB

## TYPICAL CHARACTERISTICS

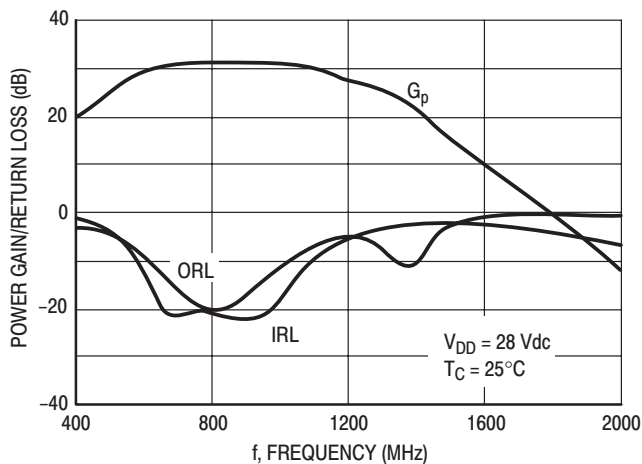

Figure 1. Power Gain, Input Return Loss, Output Return Loss versus Frequency

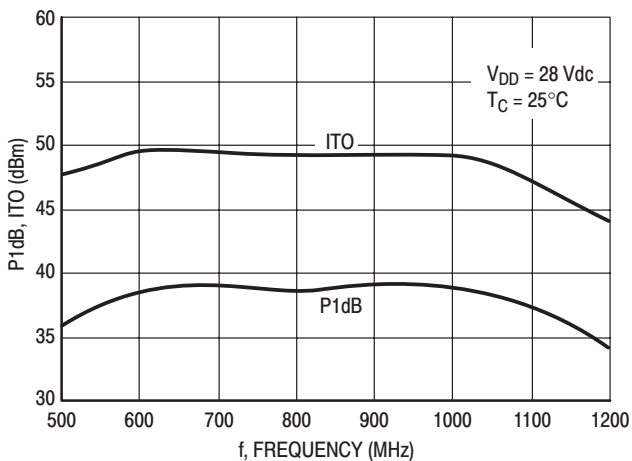

Figure 2. P1dB, ITO versus Frequency

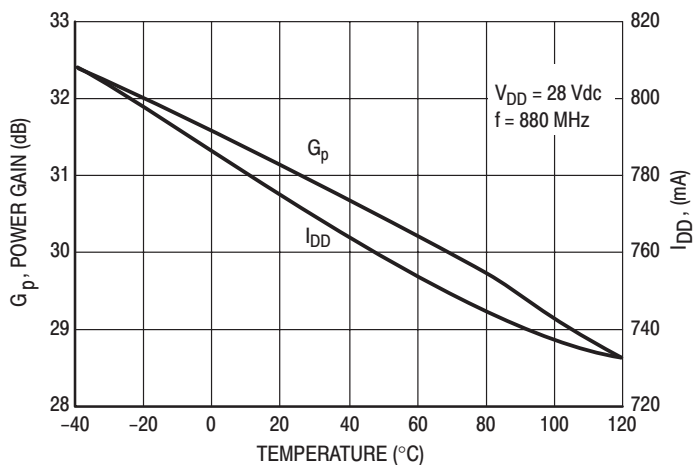

Figure 3. Power Gain,  $I_{DD}$  versus Temperature

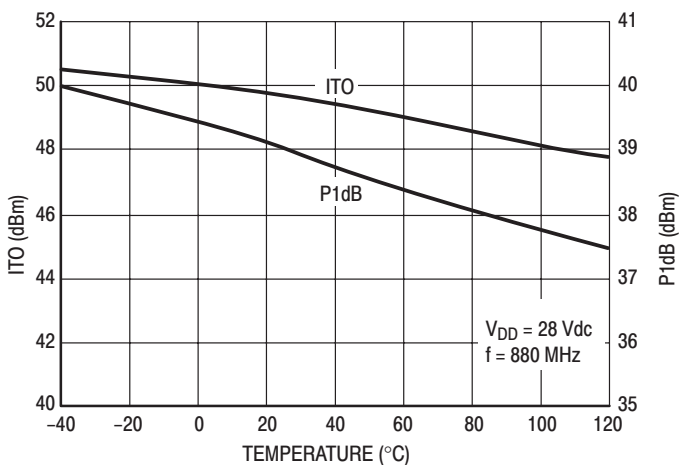

Figure 4. ITO, P1dB versus Temperature

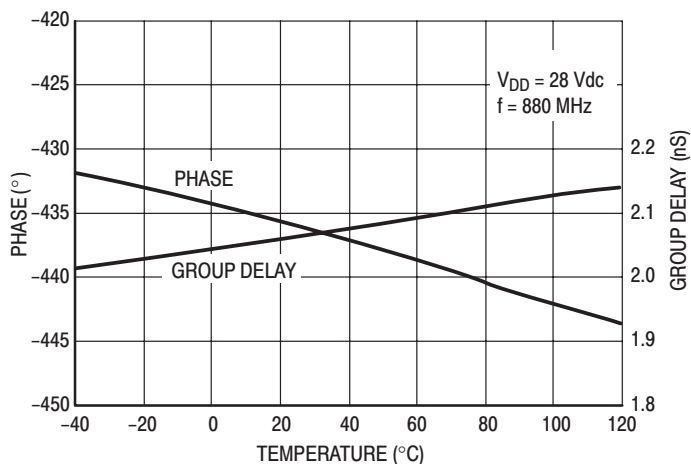

Figure 5. Phase<sup>(1)</sup>, Group Delay<sup>(1)</sup> versus Temperature

<sup>(1)</sup>In Production Test Fixture

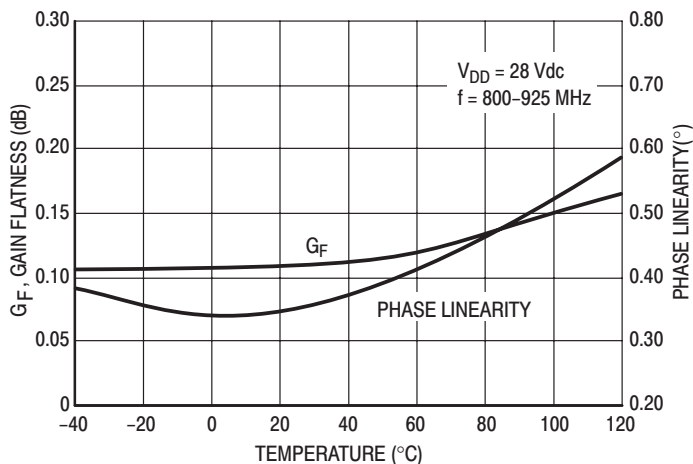

Figure 6. Gain Flatness, Phase Linearity versus Temperature

## TYPICAL CHARACTERISTICS

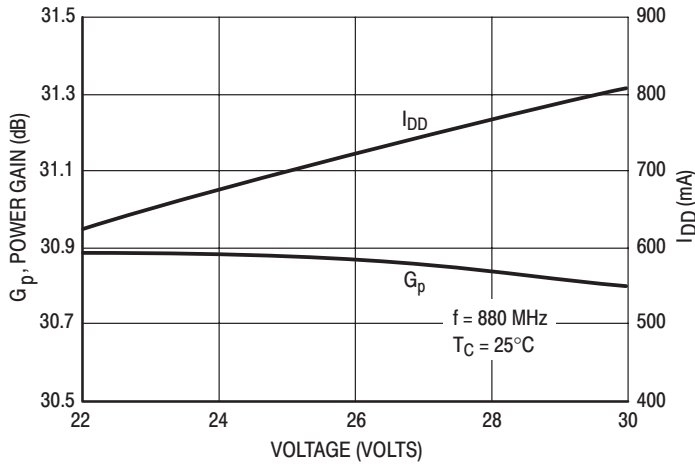

Figure 7. Power Gain,  $I_{DD}$  versus Voltage

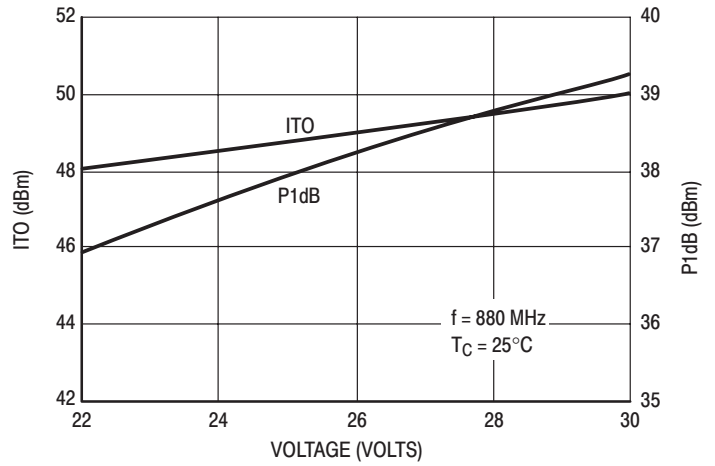

Figure 8. ITO, P1dB versus Voltage

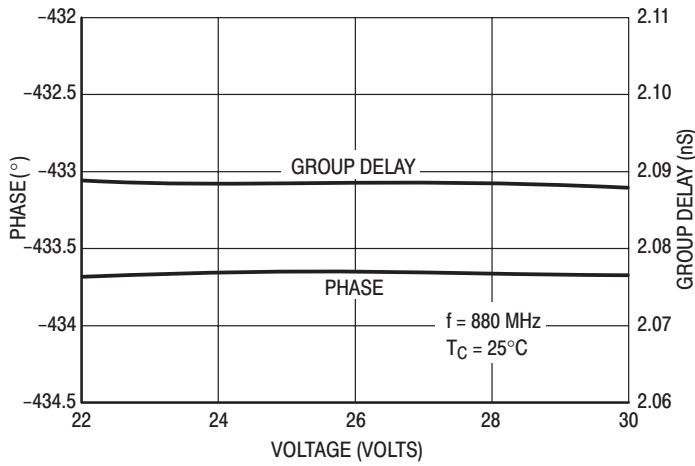

Figure 9. Phase<sup>(1)</sup>, Group Delay<sup>(1)</sup> versus Voltage  
<sup>(1)</sup>In Production Test Fixture

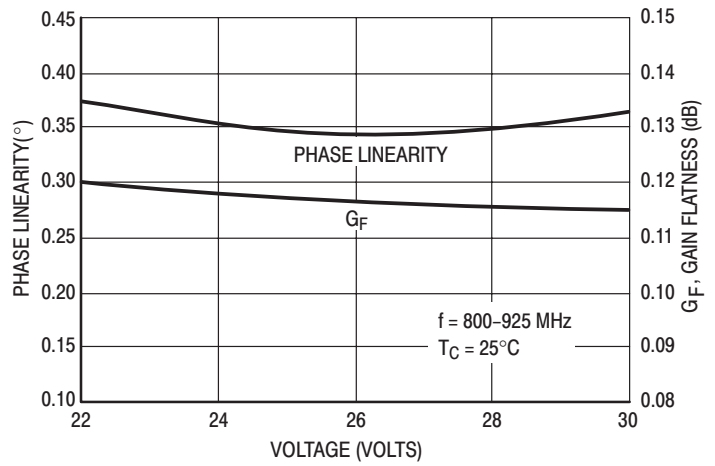
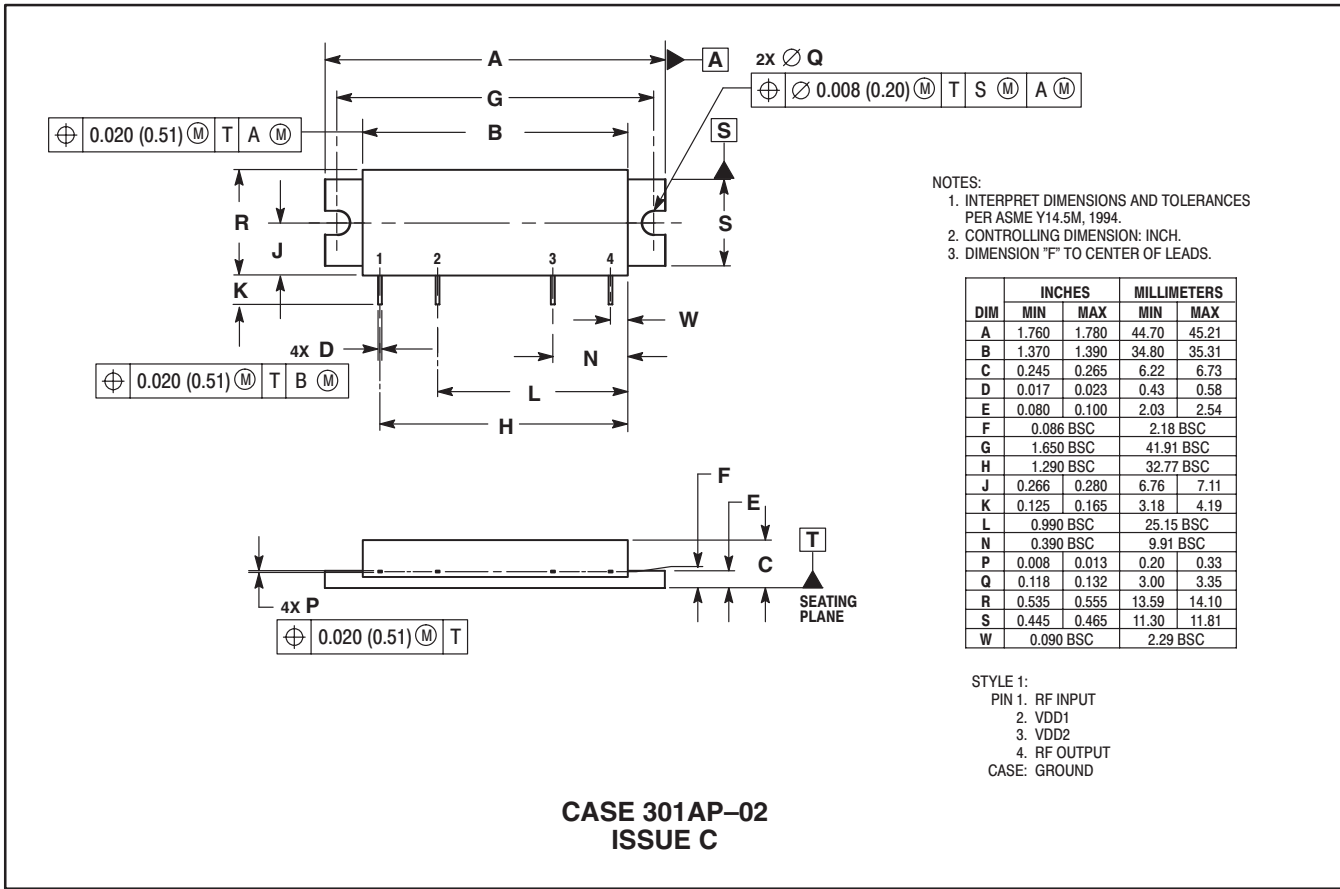

Figure 10. Phase Linearity, Gain Flatness versus Voltage

# Freescale Semiconductor, Inc.

## PACKAGE DIMENSIONS



Motorola reserves the right to make changes without further notice to any products herein. Motorola makes no warranty, representation or guarantee regarding the suitability of its products for any particular purpose, nor does Motorola assume any liability arising out of the application or use of any product or circuit, and specifically disclaims any and all liability, including without limitation consequential or incidental damages. "Typical" parameters which may be provided in Motorola data sheets and/or specifications can and do vary in different applications and actual performance may vary over time. All operating parameters, including "Typicals" must be validated for each customer application by customer's technical experts. Motorola does not convey any license under its patent rights nor the rights of others. Motorola products are not designed, intended, or authorized for use as components in systems intended for surgical implant into the body, or other applications intended to support or sustain life, or for any other application in which the failure of the Motorola product could create a situation where personal injury or death may occur. Should Buyer purchase or use Motorola products for any such unintended or unauthorized application, Buyer shall indemnify and hold Motorola and its officers, employees, subsidiaries, affiliates, and distributors harmless against all claims, costs, damages, and expenses, and reasonable attorney fees arising out of, directly or indirectly, any claim of personal injury or death associated with such unintended or unauthorized use, even if such claim alleges that Motorola was negligent regarding the design or manufacture of the part. Motorola, Inc. Motorola, Inc. is an Equal Opportunity/Affirmative Action Employer. MOTOROLA and the logo are registered in the US Patent & Trademark Office. All other product or service names are the property of their respective owners.

© Motorola, Inc. 2002.

**How to reach us:**

**USA/EUROPE/Locations Not Listed:** Motorola Literature Distribution; P.O. Box 5405, Denver, Colorado 80217. 1-303-675-2140 or 1-800-441-2447

**JAPAN:** Motorola Japan Ltd.; SPS, Technical Information Center, 3-20-1, Minami-Azabu. Minato-ku, Tokyo 106-8573 Japan. 81-3-3440-3569

**ASIA/PACIFIC:** Motorola Semiconductors H.K. Ltd.; Silicon Harbour Centre, 2 Dai King Street, Tai Po Industrial Estate, Tai Po, N.T., Hong Kong. 852-26668334

**Technical Information Center: 1-800-521-6274**

**HOME PAGE:** <http://www.motorola.com/semiconductors/>



**For More Information On This Product,  
 Go to: [www.freescale.com](http://www.freescale.com)**

MHL9838/D