



EMI/EMC Compliant, ±15 kV ESD Protected, RS-232 Line Drivers/Receivers

ADM206E/ADM207E/ADM208E/ADM211E/ADM213E

FEATURES

- Complies with 89/336/EEC EMC Directive
- ESD Protection to IEC1000-4-2 (801.2)
- ±8 kV: Contact Discharge
- ±15 kV: Air-Gap Discharge
- ±15 kV: Human Body Model
- Fast Transient Burst (EFT) Immunity (IEC1000-4-4)
- Low EMI Emissions (EN55022)
- Eliminates Costly TranZorbs*
- 460 kbits/s Data Rate Guaranteed
- Single +5 V Power Supply
- Shutdown Mode 1 μW
- Plug-In Upgrade for MAX2xxE
- Space Saving TSSOP Package Available

APPLICATIONS

- Laptop Computers
- Notebook Computers
- Printers
- Peripherals
- Modems

GENERAL DESCRIPTION

The ADM2xxE is a family of robust RS-232 and V.28 interface devices that operates from a single +5 V power supply. These products are suitable for operation in harsh electrical environments and are compliant with the EU directive on EMC (89/336/EEC). The level of emissions and immunity are both in compliance. EM immunity includes ESD protection in excess of ±15 kV on all I-O lines (1000-4-2), Fast Transient Burst protection (1000-4-4) and Radiated Immunity (1000-4-3). EM emissions include radiated and conducted emissions as required by Information Technology Equipment EN55022, CISPR22.

All devices fully conform to the EIA-232E and CCITT V.28 specifications and operate at data rates up to 230 kbps.

Shutdown and Enable control pins are provided on some of the products. Please refer to Table I.

The shutdown function on the ADM211E disables the charge pump and all transmitters and receivers. On the ADM213E the

*TranZorb is a registered trademark of General Semiconductor Industries, Inc.

FUNCTIONAL BLOCK DIAGRAM

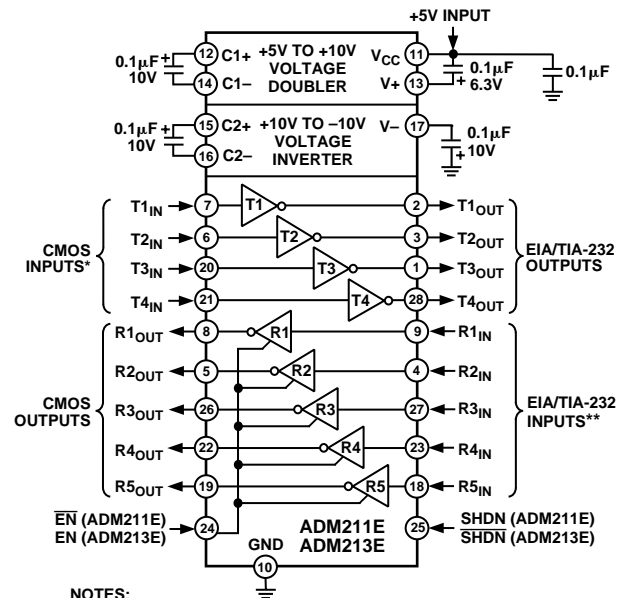

- NOTES:
 * INTERNAL 400kΩ PULL-UP RESISTOR ON EACH CMOS INPUT
 ** INTERNAL 5kΩ PULL-DOWN RESISTOR ON EACH RS-232 INPUT

charge pump, all transmitters, and three of the five receivers are disabled. The remaining two receivers remain active thereby allowing monitoring of peripheral devices. This feature allows the device to be shut down until a peripheral device begins communication. The active receivers can alert the processor which can then take the ADM213E out of the shutdown mode.

Operating from a single +5 V supply, four external 0.1 μF capacitors are required.

The ADM207E and ADM208E are available in 24-lead DIP, SO, SSOP and TSSOP packages. The ADM211E and ADM213E are available in 28-lead SO, SSOP and TSSOP packages.

All products are backward compatible with earlier ADM2xx products facilitating easy upgrading of older designs.

Table I. Selection Table

Model	Supply Voltage	Drivers	Receivers	ESD Protection	Shutdown	Enable	Packages
ADM206E	+5 V	4	3	±15 kV	Yes	Yes	R-24
ADM207E	+5 V	5	3	±15 kV	No	No	N, R, RS, RU-24
ADM208E	+5 V	4	4	±15 kV	No	No	N, R, RS, RU-24
ADM211E	+5 V	4	5	±15 kV	Yes	Yes	R, RS, RU-28
ADM213E	+5 V	4	5	±15 kV	Yes (SD)*	Yes (EN)	R, RS, RU-28

*Two receivers active.

REV. B

Information furnished by Analog Devices is believed to be accurate and reliable. However, no responsibility is assumed by Analog Devices for its use, nor for any infringements of patents or other rights of third parties which may result from its use. No license is granted by implication or otherwise under any patent or patent rights of Analog Devices.

ADM206E/ADM207E/ADM208E/ADM211E/ADM213E—SPECIFICATIONS

($V_{CC} = +5.0\text{ V} \pm 10\%$, $C1-C4 = 0.1\ \mu\text{F}$. All specifications T_{MIN} to T_{MAX} unless otherwise noted.)

Parameter	Min	Typ	Max	Units	Test Conditions/Comments
Operating Voltage Range V_{CC} Power Supply Current	+4.5	+5.0	+5.5	Volts mA	No Load
Shutdown Supply Current		0.2	5	μA	
Input Pull-Up Current		10	25	μA	$T_{IN} = \text{GND}$
Input Logic Threshold Low, V_{INL}			0.8	V	$T_{IN}, \text{EN}, \overline{\text{EN}}, \text{SHDN}, \overline{\text{SHDN}}$,
Input Logic Threshold High, V_{INH}	2.0			V	T_{IN}
Input Logic Threshold High, V_{INH}	2.4			V	$\text{EN}, \overline{\text{EN}}, \text{SHDN}, \overline{\text{SHDN}}$
CMOS Output Voltage Low, V_{OL}			0.4	V	$I_{OUT} = 1.6\ \text{mA}$
CMOS Output Voltage High, V_{OH}	3.5			V	$I_{OUT} = -40\ \mu\text{A}$
CMOS Output Leakage Current		0.05	± 5	μA	$\overline{\text{EN}} = V_{CC}, \text{EN} = \text{GND}, 0\ \text{V} \leq R_{OUT} \leq V_{CC}$
EIA-232 Input Voltage Range	-30		+30	V	
EIA-232 Input Threshold Low	0.4	1.3		V	
EIA-232 Input Threshold High		2.0	2.4	V	
EIA-232 Input Hysteresis	0.2	0.7	1.0	V	
EIA-232 Input Resistance	3	5	7	k Ω	
Output Voltage Swing	± 5.0	± 9.0		Volts	All Transmitter Outputs Loaded with 3 k Ω to Ground
Transmitter Output Resistance	300			Ω	$V_{CC} = 0\ \text{V}, V_{OUT} = \pm 2\ \text{V}$
RS-232 Output Short Circuit Current	± 10	± 20	± 60	mA	
Maximum Data Rate	230 460			kbps kbps	$R_L = 3\ \text{k}\Omega$ to 7 k Ω , $C_L = 50\ \text{pF}$ to 2500 pF $C_L = 1000\ \text{pF}$ (ADM206E)
Receiver Propagation Delay TPHL, TPLH		0.4	2	μs	$C_L = 150\ \text{pF}$
Receiver Output Enable Time, t_{ER}		120		ns	
Receiver Output Disable Time, t_{DR}		120		ns	
Transmitter Propagation Delay TPHL, TPLH		1		μs	$R_L = 3\ \text{k}\Omega$, $C_L = 2500\ \text{pF}$
Transition Region Slew Rate	3	10	30	V/ μs	$R_L = 3\ \text{k}\Omega$, $C_L = 50\ \text{pF}$ to 2500 pF Measured from +3 V to -3 V or -3 V to +3 V
ESD Protection (I-O Pins)		± 15 ± 15 ± 8		kV kV kV	Human Body Model IEC1000-4-2 Air Discharge IEC1000-4-2 Contact Discharge
ESD Protection (All Other Pins)		± 2.5		kV	Human Body Model, MIL-STD-883B
EFT Protection (I-O Pins)		± 2		kV	IEC1000-4-4
EMI Immunity		10		V/m	IEC1000-4-3

Specifications subject to change without notice.

ADM206E/ADM207E/ADM208E/ADM211E/ADM213E

ABSOLUTE MAXIMUM RATINGS*

(T_A = +25°C unless otherwise noted)

V_{CC} -0.3 V to +6 V
 V+ (V_{CC}-0.3 V) to +14 V
 V- +0.3 V to -14 V

Input Voltages

T_{IN} -0.3 V to (V+, +0.3 V)
 R_{IN} ±30 V

Output Voltages

T_{OUT} ±15 V
 R_{OUT} -0.3 V to (V_{CC}+0.3 V)

Short Circuit Duration

T_{OUT} Continuous

Power Dissipation

N-24 DIP (Derate 13.5 mW/°C Above +70°C) .. 1000 mW
 R-24 SOIC (Derate 12 mW/°C Above +70°C) .. 900 mW
 RS-24 SSOP (Derate 12 mW/°C Above +70°C) 850 mW

RU-24 TSSOP (Derate 12 mW/°C Above +70°C) .. 900 mW
 R-28 SOIC (Derate 12 mW/°C Above +70°C) 900 mW
 RS-28 SSOP (Derate 10 mW/°C Above +70°C) 900 mW
 RU-28 TSSOP (Derate 12 mW/°C Above +70°C) .. 900 mW

Operating Temperature Range

Industrial (A Version) -40°C to +85°C
 Storage Temperature Range -65°C to +150°C
 Lead Temperature (Soldering, 10 sec) +300°C
 ESD Rating (MIL-STD-883B) (I-O Pins) ±15 kV
 ESD Rating (MIL-STD-883B) (Except I-O) ±2.5 kV
 ESD Rating (IEC1000-4-2 Air) (I-O Pins) ±15 kV
 ESD Rating (IEC1000-4-2 Contact) (I-O Pins) ±8 kV
 EFT Rating (IEC1000-4-4) (I-O Pins) ±2 kV

*This is a stress rating only and functional operation of the device at these or any other conditions above those indicated in the operation sections of this specification is not implied. Exposure to absolute maximum rating conditions for extended periods of time may affect reliability.

Table II. ADM211E Truth Table

SHDN	$\overline{\text{EN}}$	Status	T _{OUT1-4}	R _{OUT1-5}
0	0	Normal Operation	Enabled	Enabled
0	1	Normal Operation	Enabled	Disabled
1	X	Shutdown	Disabled	Disabled

X = Don't Care.

Table III. ADM213E Truth Table

SHDN	EN	Status	T _{OUT1-4}	R _{OUT1-3}	R _{OUT4-5}
0	0	Shutdown	Disabled	Disabled	Disabled
0	1	Shutdown	Disabled	Disabled	Enabled
1	0	Normal Operation	Enabled	Disabled	Disabled
1	1	Normal Operation	Enabled	Enabled	Enabled

ORDERING GUIDE

Model	Temperature Range	Package Option
ADM206EAR	-40°C to +85°C	R-24
ADM207EAN	-40°C to +85°C	N-24
ADM207EAR	-40°C to +85°C	R-24
ADM207EARS	-40°C to +85°C	RS-24
ADM207EARU	-40°C to +85°C	RU-24
ADM208EAN	-40°C to +85°C	N-24
ADM208EAR	-40°C to +85°C	R-24
ADM208EARS	-40°C to +85°C	RS-24
ADM208EARU	-40°C to +85°C	RU-24
ADM211EAR	-40°C to +85°C	R-28
ADM211EARS	-40°C to +85°C	RS-28
ADM211EARU	-40°C to +85°C	RU-28
ADM213EAR	-40°C to +85°C	R-28
ADM213EARS	-40°C to +85°C	RS-28
ADM213EARU	-40°C to +85°C	RU-28

ADM206E/ADM207E/ADM208E/ADM211E/ADM213E

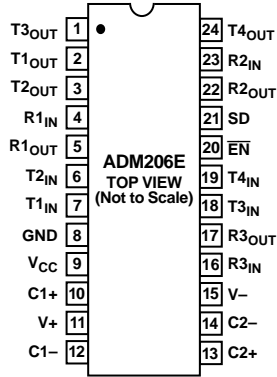

Figure 1. ADM206E DIP/SOIC/SSOP Pin Configuration

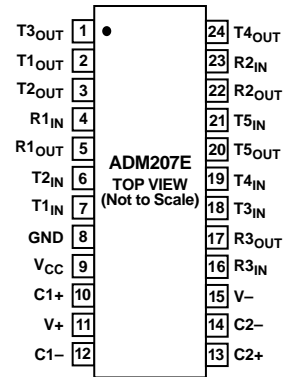
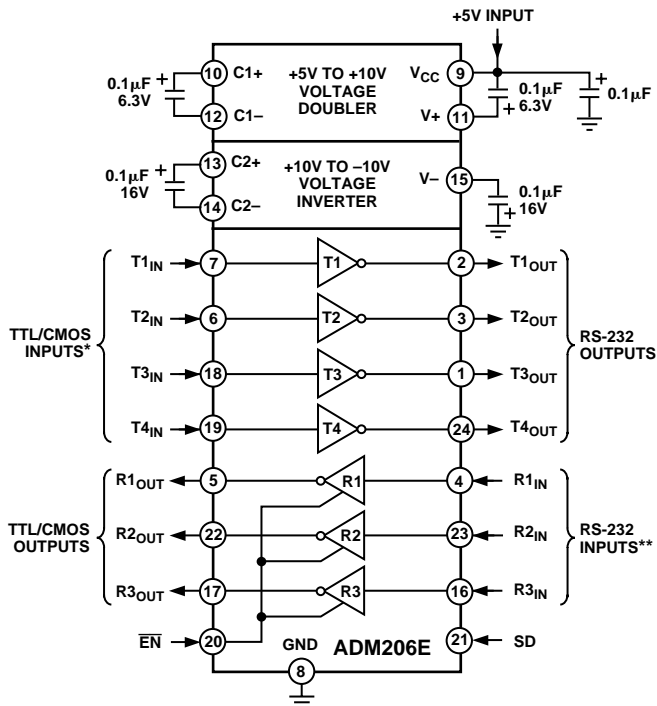
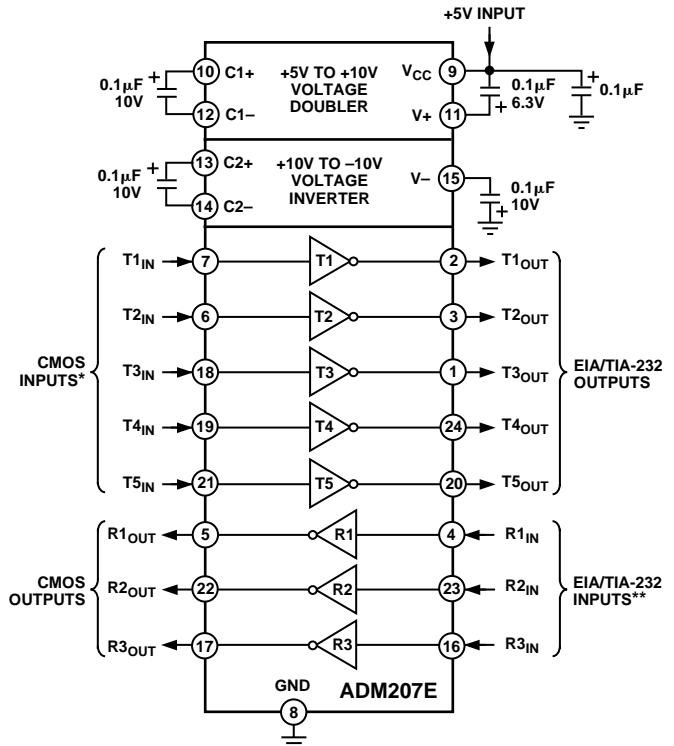

Figure 3. ADM207E Pin Configuration



*INTERNAL 400kΩ PULL-UP RESISTOR ON EACH TTL/CMOS INPUT
 **INTERNAL 5kΩ PULL-DOWN RESISTOR ON EACH RS-232 INPUT

Figure 2. ADM206E Typical Operating Circuit



*INTERNAL 400kΩ PULL-UP RESISTOR ON EACH CMOS INPUT
 **INTERNAL 5kΩ PULL-DOWN RESISTOR ON EACH RS-232 INPUT

Figure 4. ADM207E Typical Operating Circuit

ADM206E/ADM207E/ADM208E/ADM211E/ADM213E

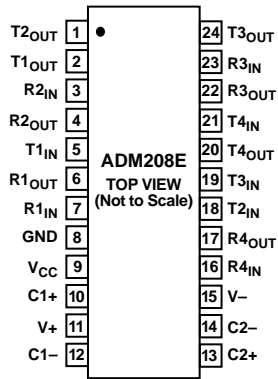

Figure 5. ADM208E Pin Configuration

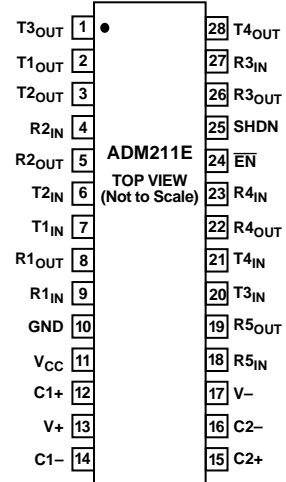
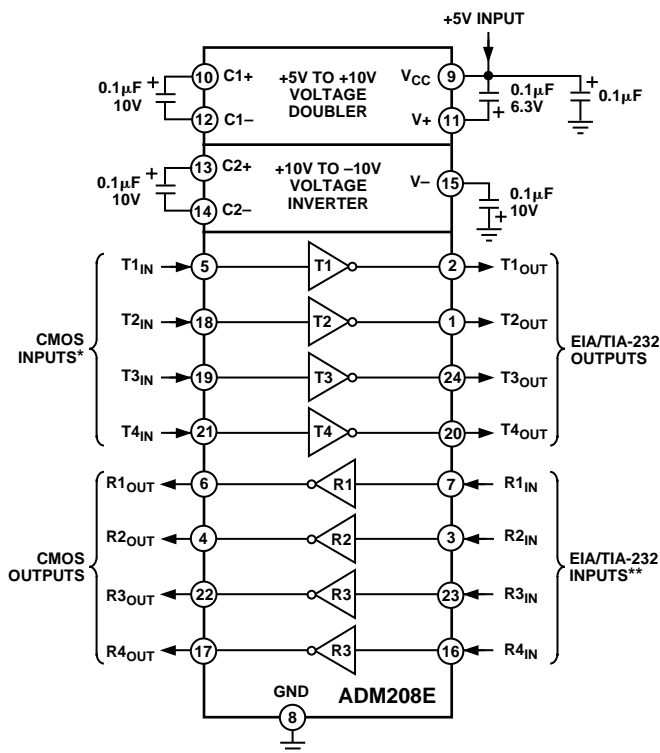
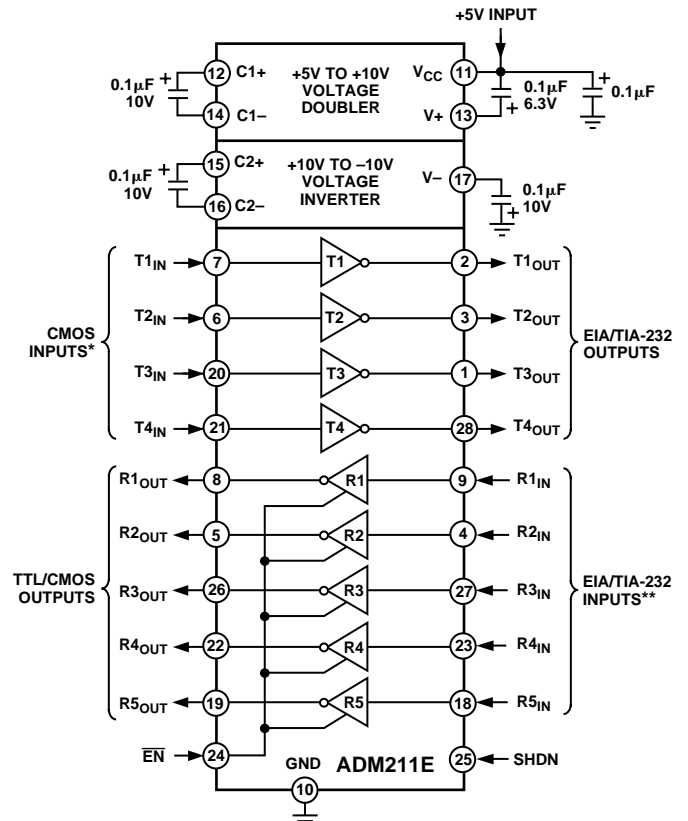

Figure 7. ADM211E Pin Configuration



*INTERNAL 400kΩ PULL-UP RESISTOR ON EACH CMOS INPUT
 **INTERNAL 5kΩ PULL-DOWN RESISTOR ON EACH RS-232 INPUT

Figure 6. ADM208E Typical Operating Circuit



*INTERNAL 400kΩ PULL-UP RESISTOR ON EACH CMOS INPUT
 **INTERNAL 5kΩ PULL-DOWN RESISTOR ON EACH RS-232 INPUT

Figure 8. ADM211E Typical Operating Circuit

ADM206E/ADM207E/ADM208E/ADM211E/ADM213E

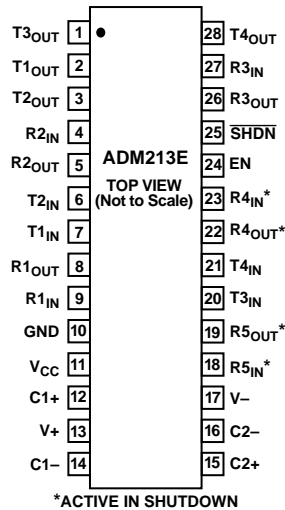

Figure 9. ADM213E Pin Configuration

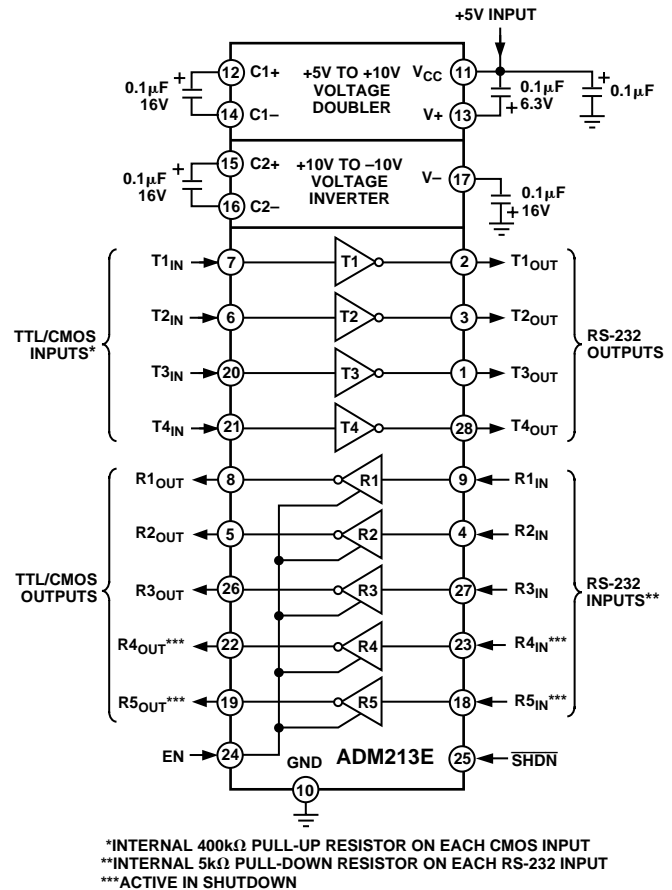

Figure 10. ADM213E Typical Operating Circuit

PIN FUNCTION DESCRIPTIONS

Mnemonic	Function
V_{CC}	Power Supply Input: +5 V \pm 10%.
V+	Internally Generated Positive Supply (+9 V nominal).
V-	Internally Generated Negative Supply (-9 V nominal).
GND	Ground Pin. Must Be Connected to 0 V.
C1+, C1-	External Capacitor 1 is connected between these pins. 0.1 μ F capacitor is recommended but larger capacitors up to 47 μ F may be used.
C2+, C2-	External Capacitor 2 is connected between these pins. 0.1 μ F capacitor is recommended but larger capacitors up to 47 μ F may be used.
T_{IN}	Transmitter (Driver) Inputs. These inputs accept TTL/CMOS levels. An internal 400 k Ω pull-up resistor to V_{CC} is connected on each input.
T_{OUT}	Transmitter (Driver) Outputs. These are RS-232 signal levels (Typically \pm 9 V).
R_{IN}	Receiver Inputs. These inputs accept RS-232 signal levels. An internal 5 k Ω pull-down resistor to GND is connected on each input.
R_{OUT}	Receiver Outputs. These are CMOS output logic levels.
$\overline{EN}/\overline{EN}$	Receiver Enable (Active High on ADM213E, Active Low on ADM211E); This input is used to enable/disable the receiver outputs. With \overline{EN} = Low ADM211E (EN = High ADM213E), the receiver outputs are enabled. With \overline{EN} = High (EN = Low ADM213E), the receiver outputs are placed in a high impedance state.
$\overline{SHDN}/\overline{SHDN}$	Shutdown Control (Active Low on ADM213E, Active High on ADM211E); Refer to Table II. In shutdown the charge pump is disabled, the transmitter outputs are turned off and all receiver outputs (ADM211E), receivers R1, R2, R3 (ADM213E) are placed in a high impedance state. Receivers R4 and R5 on the ADM213E continue to operate normally during shutdown. Power consumption in shutdown for all parts reduces to 5 μ W.

Typical Performance Curves

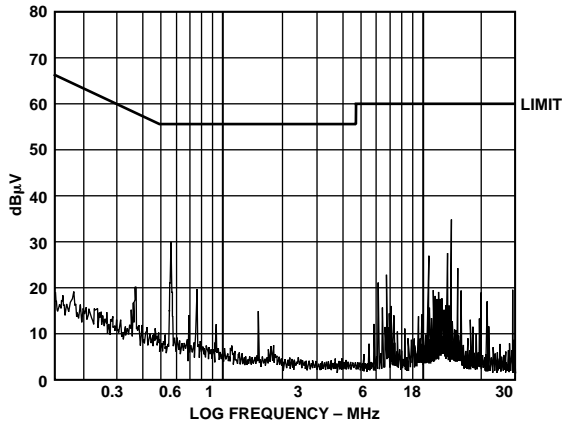

Figure 11. EMC Conducted Emissions

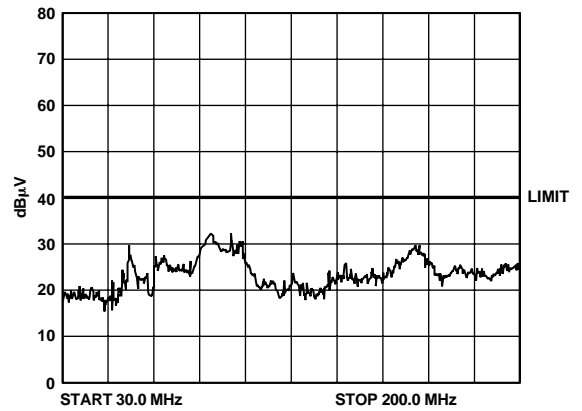

Figure 14. EMC Radiated Emissions

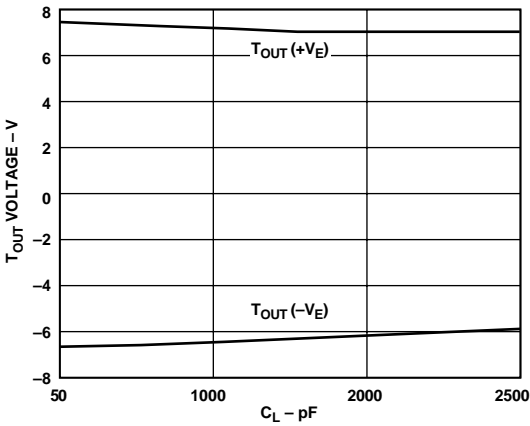

Figure 12. Transmitter Output Voltage High/Low vs. Load Capacitance @ 230 kbps

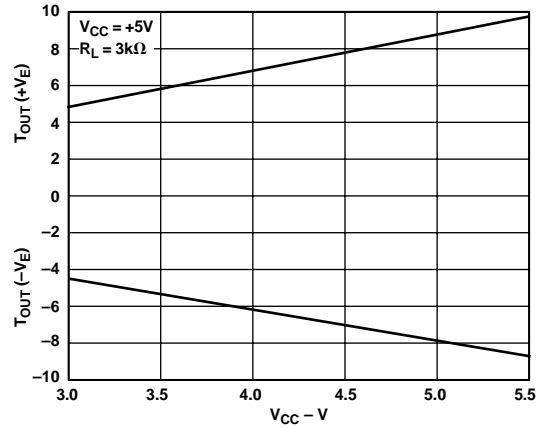

Figure 15. Transmitter Output Voltage vs. V_{CC}

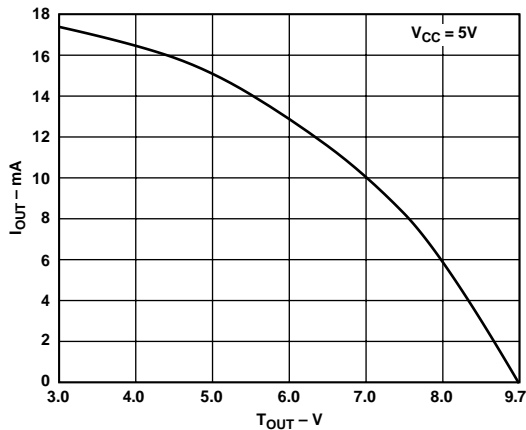

Figure 13. Transmitter Output Voltage High vs. Load Current

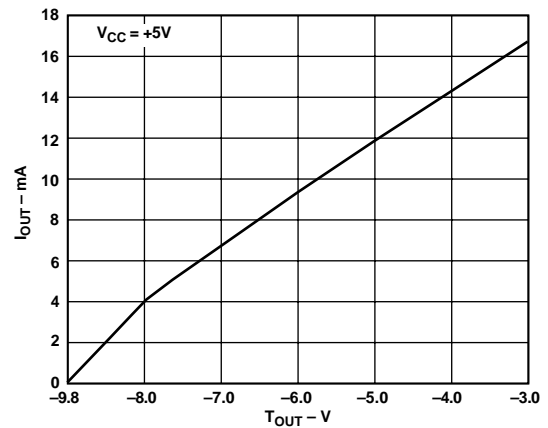

Figure 16. Transmitter Output Voltage Low vs. Load Current

ADM206E/ADM207E/ADM208E/ADM211E/ADM213E

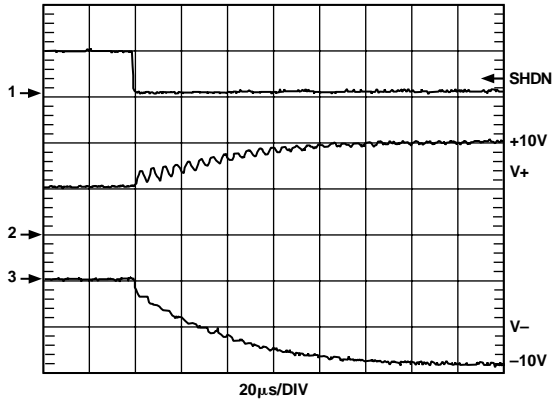

Figure 17. Charge Pump V_+ , V_- Exiting Shutdown

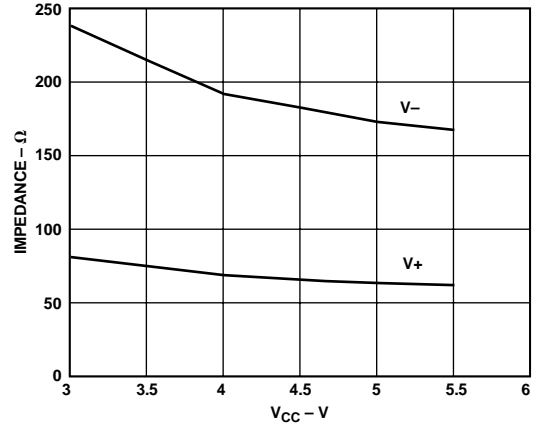

Figure 18. Charge Pump Impedance vs. V_{CC}

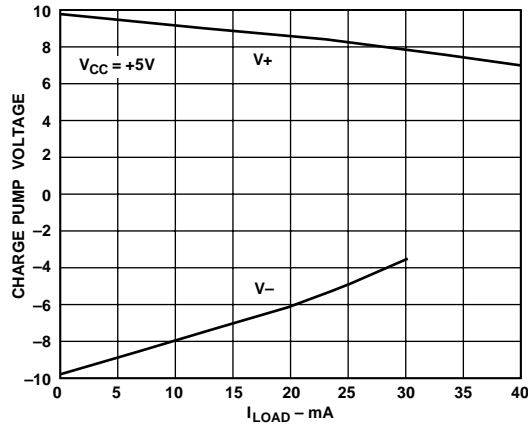

Figure 19. Charge Pump V_+ , V_- vs. Current

ADM206E/ADM207E/ADM208E/ADM211E/ADM213E

GENERAL DESCRIPTION

The ADM206E/ADM207E/ADM208E/ADM211E/ADM213E are ruggedized RS-232 line drivers/receivers which operate from a single +5 V supply. Step-up voltage converters coupled with level shifting transmitters and receivers allow RS-232 levels to be developed while operating from a single +5 V supply. Features include low power consumption, high transmission rates and compatibility with the EU directive on electromagnetic compatibility. EM compatibility includes protection against radiated and conducted interference including high levels of electrostatic discharge.

All RS-232 inputs and outputs contain protection against electrostatic discharges up to ± 15 kV and electrical fast transients up to ± 2 kV. This ensures compliance to IE1000-4-2 and IEC1000-4-4 requirements.

The devices are ideally suited for operation in electrically harsh environments or where RS-232 cables are frequently being plugged/unplugged. They are also immune to high RF field strengths without special shielding precautions.

Emissions are also controlled to within very strict limits. CMOS technology is used to keep the power dissipation to an absolute minimum allowing maximum battery life in portable applications. The ADMxxE is a modification, enhancement and improvement to the AD230–AD241 family and derivatives thereof. It is essentially plug-in compatible and does not have materially different applications.

CIRCUIT DESCRIPTION

The internal circuitry consists of four main sections. These are:

1. A charge pump voltage converter.
2. 5 V logic to EIA-232 transmitters.
3. EIA-232 to 5 V logic receivers.
4. Transient protection circuit on all I-O lines.

Charge Pump DC-DC Voltage Converter

The charge pump voltage converter consists of an 200 kHz oscillator and a switching matrix. The converter generates a ± 10 V supply from the input +5 V level. This is done in two stages using a switched capacitor technique as illustrated below. First, the 5 V input supply is doubled to 10 V using capacitor C1 as the charge storage element. The 10 V level is then inverted to generate -10 V using C2 as the storage element.

Capacitors C3 and C4 are used to reduce the output ripple. If desired, larger capacitors (up to 47 μ F) can be used for capacitors C1–C4. This facilitates direct substitution with older generation charge pump RS-232 transceivers.

The V+ and V– supplies may also be used to power external circuitry if the current requirements are small. Please refer to Figure 19 in the Typical Performance section.

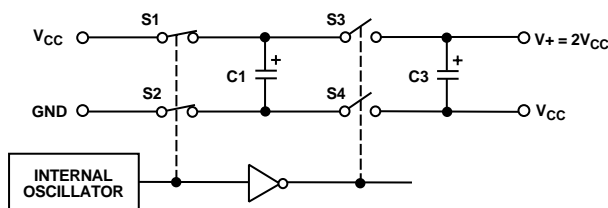

Figure 20. Charge Pump Voltage Doubler

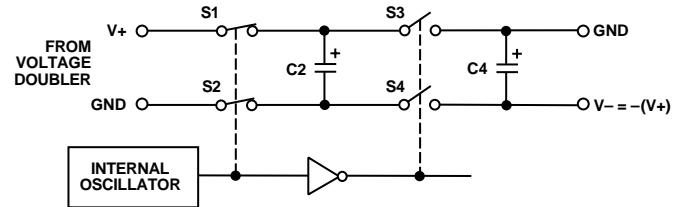

Figure 21. Charge Pump Voltage Inverter

Transmitter (Driver) Section

The drivers convert 5 V logic input levels into EIA-232 output levels. With $V_{CC} = +5$ V and driving an EIA-232 load, the output voltage swing is typically ± 9 V.

Unused inputs may be left unconnected, as an internal 400 k Ω pull-up resistor pulls them high forcing the outputs into a low state. The input pull-up resistors typically source 8 μ A when grounded, so unused inputs should either be connected to V_{CC} or left unconnected in order to minimize power consumption.

Receiver Section

The receivers are inverting level shifters which accept EIA-232 input levels and translate them into 5 V logic output levels. The inputs have internal 5 k Ω pull-down resistors to ground and are also protected against overvoltages of up to ± 25 V. The guaranteed switching thresholds are 0.4 V minimum and 2.4 V maximum. Unconnected inputs are pulled to 0 V by the internal 5 k Ω pull-down resistor. This, therefore, results in a Logic 1 output level for unconnected inputs or for inputs connected to GND.

The receivers have Schmitt trigger input with a hysteresis level of 0.5 V. This ensures error-free reception for both noisy inputs and for inputs with slow transition times.

ENABLE AND SHUTDOWN

Table II and Table III show the truth tables for the enable and shutdown control signals. The enable function is intended to facilitate data bus connections where it is desirable to three state the receiver outputs. In the disabled mode, all receiver outputs are placed in a high impedance state. The shutdown function is intended to shut the device down, thereby minimizing the quiescent current. In shutdown, all transmitters are disabled and all receivers on the ADM211E are three-stated. On the ADM213E, receivers R4 and R5 remain enabled in shutdown. Note that the transmitters are disabled but are not three-stated in shutdown, so it is not permitted to connect multiple (RS-232) driver outputs together.

The shutdown feature is very useful in battery operated systems since it reduces the power consumption to 1 μ W. During shutdown the charge pump is also disabled. The shutdown control input is active high on the ADM211E, and it is active low on the ADM213E. When exiting shutdown, the charge pump is restarted and it takes approximately 100 μ s for it to reach its steady state operating conditions.

High Baud Rate

The ADM2xxE feature high slew rates permitting data transmission at rates well in excess of the EIA-232-E specifications. RS-232 levels are maintained at data rates up to 230 kb/s even under worst case loading conditions. This allows for high speed data links between two terminals or indeed it is suitable for the

ADM206E/ADM207E/ADM208E/ADM211E/ADM213E

new generation modem standards which requires data rates of 200 kb/s. The slew rate is internally controlled to less than 30 V/ μ s in order to minimize EMI interference.

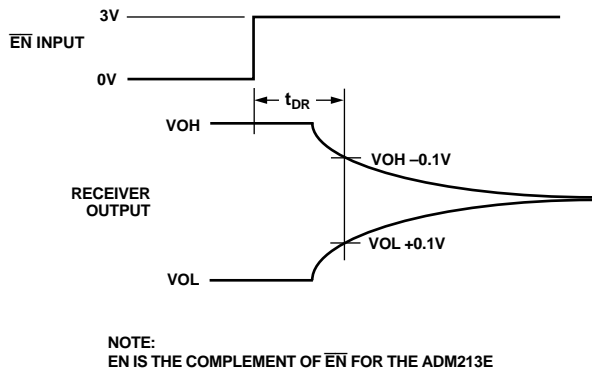

Figure 22. Receiver-Disable Timing

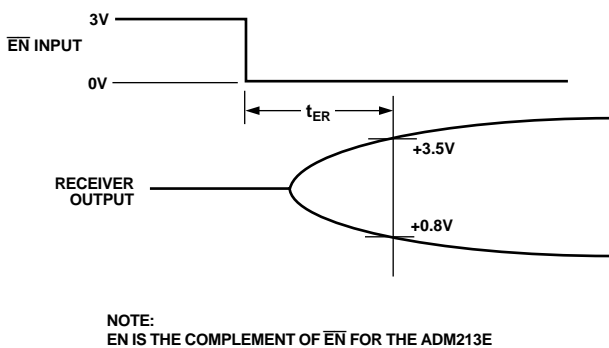

Figure 23. Receiver Enable Timing

ESD/EFT Transient Protection Scheme

The ADM2xxE uses protective clamping structures on all inputs and outputs which clamps the voltage to a safe level and dissipates the energy present in ESD (Electrostatic) and EFT (Electrical Fast Transients) discharges. A simplified schematic of the protection structure is shown in Figures 24a and 24b. Each input and output contains two back-to-back high speed clamping diodes. During normal operation with maximum RS-232 signal levels, the diodes have no affect as one or the other is reverse biased depending on the polarity of the signal. If however the voltage exceeds about ± 50 V, reverse breakdown occurs and the voltage is clamped at this level. The diodes are large p-n junctions which are designed to handle the instantaneous current surge which can exceed several amperes.

The transmitter outputs and receiver inputs have a similar protection structure. The receiver inputs can also dissipate some of the energy through the internal 5 k Ω resistor to GND as well as through the protection diodes.

The protection structure achieves ESD protection up to ± 15 kV and EFT protection up to ± 2 kV on all RS-232 I-O lines. The methods used to test the protection scheme are discussed later.

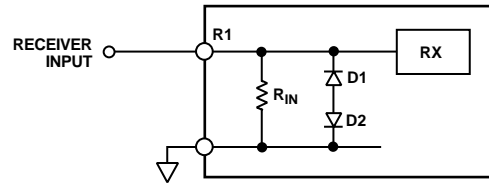

Figure 24a. Receiver Input Protection Scheme

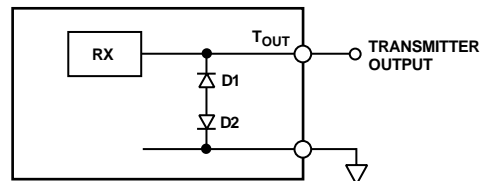

Figure 24b. Transmitter Output Protection Scheme

ESD TESTING (IEC1000-4-2)

IEC1000-4-2 (previously 801-2) specifies compliance testing using two coupling methods, contact discharge and air-gap discharge. Contact discharge calls for a direct connection to the unit being tested. Air-gap discharge uses a higher test voltage but does not make direct contact with the unit under test. With air discharge, the discharge gun is moved towards the unit under test developing an arc across the air gap, hence the term air-discharge. This method is influenced by humidity, temperature, barometric pressure, distance and rate of closure of the discharge gun. The contact-discharge method while less realistic is more repeatable and is gaining acceptance in preference to the air-gap method.

Although very little energy is contained within an ESD pulse, the extremely fast rise time coupled with high voltages can cause failures in unprotected semiconductors. Catastrophic destruction can occur immediately as a result of arcing or heating. Even if catastrophic failure does not occur immediately, the device may suffer from parametric degradation which may result in degraded performance. The cumulative effects of continuous exposure can eventually lead to complete failure.

I-O lines are particularly vulnerable to ESD damage. Simply touching or plugging in an I-O cable can result in a static discharge that can damage or completely destroy the interface product connected to the I-O port. Traditional ESD test methods such as the MIL-STD-883B method 3015.7 do not fully test a products susceptibility to this type of discharge. This test was intended to test a products susceptibility to ESD damage during handling. Each pin is tested with respect to all other pins. There are some important differences between the traditional test and the IEC test:

- The IEC test is much more stringent in terms of discharge energy. The peak current injected is over four times greater.
- The current rise time is significantly faster in the IEC test.
- The IEC test is carried out while power is applied to the device.

It is possible that the ESD discharge could induce latch-up in the device under test. This test therefore is more representative of a real-world I-O discharge where the equipment is operating normally with power applied. For maximum peace of mind however, both tests should be performed, therefore, ensuring maximum protection both during handling and later during field service.

ADM206E/ADM207E/ADM208E/ADM211E/ADM213E

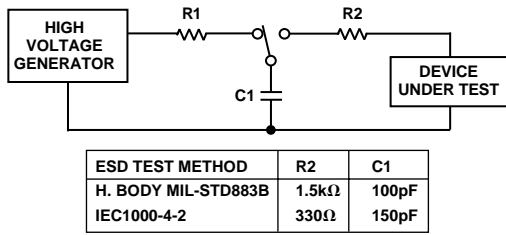

Figure 25. ESD Test Standards

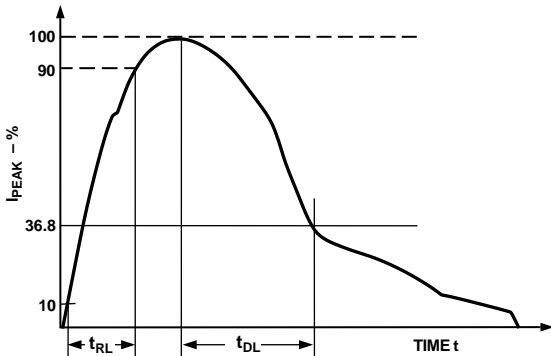

Figure 26. Human Body Model ESD Current Waveform

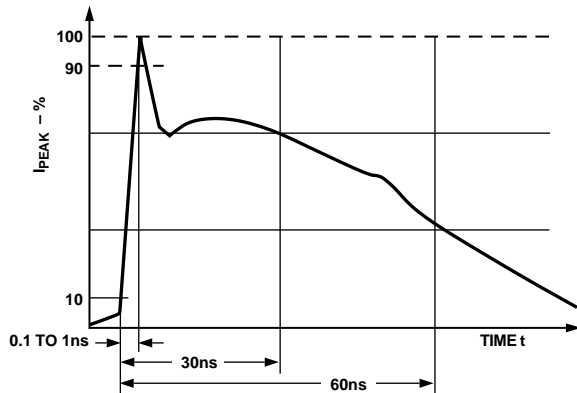

Figure 27. IEC1000-4-2 ESD Current Waveform

The ADM2xxE family of products are tested using both the above mentioned test methods. All pins are tested with respect to all other pins as per the MIL-STD-883B specification. In addition all I-O pins are tested as per the IEC test specification. The products were tested under the following conditions:

- (a) Power-On—Normal Operation
- (b) Power-On—Shutdown Mode
- (c) Power-Off

There are four levels of compliance defined by IEC1000-4-2. The ADM2xxE family of products meet the most stringent compliance level for both contact and for air-gap discharge. This means that the products are able to withstand contact discharges in excess of 8 kV and air-gap discharges in excess of 15 kV.

Table IV. IEC1000-4-2 Compliance Levels

Level	Contact Discharge kV	Air Discharge kV
1	2	2
2	4	4
3	6	8
4	8	15

Table V. ADM2xxE ESD Test Results

ESD Test Method	I-O Pins	Other Pins
MIL-STD-883B	±15 kV	±2.5 kV
IEC1000-4-2		
Contact	±8 kV	
Air	±15 kV	

FAST TRANSIENT BURST TESTING (IEC1000-4-4)

IEC1000-4-4 (previously 801-4) covers electrical fast-transient/burst (EFT) immunity. Electrical fast transients occur as a result of arcing contacts in switches and relays. The tests simulate the interference generated when for example a power relay disconnects an inductive load. A spark is generated due to the well known back EMF effect. In fact the spark consists of a burst of sparks as the relay contacts separate. The voltage appearing on the line, therefore, consists of a burst of extremely fast transient impulses. A similar effect occurs when switching on fluorescent lights.

The fast transient burst test defined in IEC1000-4-4 simulates this arcing and its waveform is illustrated in Figure 28. It consists of a burst of 2.5 kHz to 5 kHz transients repeating at 300 ms intervals. It is specified for both power and data lines.

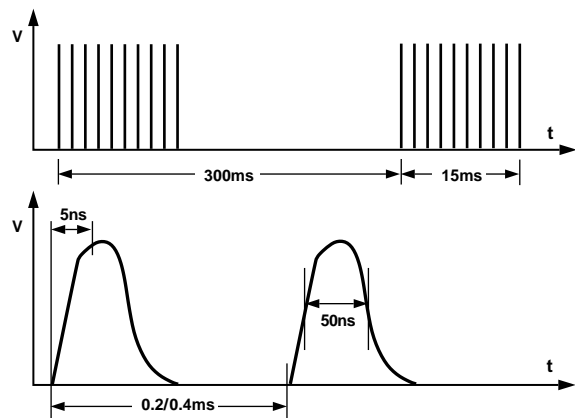

Figure 28. IEC1000-4-4 Fast Transient Waveform

ADM206E/ADM207E/ADM208E/ADM211E/ADM213E

Table VI.

Level	V Peak (kV) PSU	V Peak (kV) I-O
1	0.5	0.25
2	1	0.5
3	2	1
4	4	2

A simplified circuit diagram of the actual EFT generator is illustrated in Figure 29.

The transients are coupled onto the signal lines using an EFT coupling clamp. The clamp is 1 m long and it completely surrounds the cable providing maximum coupling capacitance (50 pF to 200 pF typ) between the clamp and the cable. High energy transients are capacitively coupled onto the signal lines. Fast rise times (5 ns) as specified by the standard result in very effective coupling. This test is very severe since high voltages are coupled onto the signal lines. The repetitive transients can often cause problems where single pulses don't. Destructive latch-up may be induced due to the high energy content of the transients. Note that this stress is applied while the interface products are powered up and are transmitting data. The EFT test applies hundreds of pulses with higher energy than ESD. Worst case transient current on an I-O line can be as high as 40A.

Test results are classified according to the following:

1. Normal performance within specification limits.
2. Temporary degradation or loss of performance which is self-recoverable.
3. Temporary degradation or loss of function or performance which requires operator intervention or system reset.
4. Degradation or loss of function which is not recoverable due to damage.

The ADM2xxE have been tested under worst case conditions using unshielded cables and meet Classification 2. Data transmission during the transient condition is corrupted but it may be resumed immediately following the EFT event without user intervention.

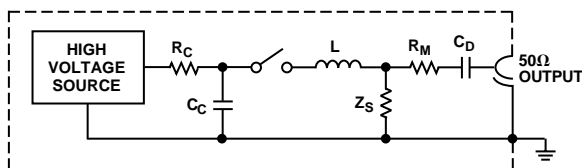

Figure 29. IEC1000-4-4 Fast Transient Generator

IEC1000-4-3 RADIATED IMMUNITY

IEC1000-4-3 (previously IEC801-3) describes the measurement method and defines the levels of immunity to radiated electromagnetic fields. It was originally intended to simulate the electromagnetic fields generated by portable radio transceivers or any other device which generates continuous wave radiated electromagnetic energy. Its scope has since been broadened to include spurious EM energy which can be radiated from fluorescent lights, thyristor drives, inductive loads, etc.

Testing for immunity involves irradiating the device with an EM field. There are various methods of achieving this including use of anechoic chamber, stripline cell, TEM cell, GTEM cell. A stripline cell consists of two parallel plates with an electric field developed between them. The device under test is placed within the cell and exposed to the electric field. There are three severity levels having field strengths ranging from 1 V to 10 V/m. Results are classified in a similar fashion to those for IEC1000-4-4.

1. Normal operation.
2. Temporary degradation or loss of function which is self-recoverable when the interfering signal is removed.
3. Temporary degradation or loss of function which requires operator intervention or system reset when the interfering signal is removed.
4. Degradation or loss of function which is not recoverable due to damage.

The ADM2xxE family of products easily meets Classification 1 at the most stringent (Level 3) requirement. In fact field strengths up to 30 V/m showed no performance degradation and error-free data transmission continued even during irradiation.

Table VII. Test Severity Levels (IEC1000-4-3)

Level	Field Strength V/m
1	1
2	3
3	10

EMISSIONS/INTERFERENCE

EN55 022, CISPR22 defines the permitted limits of radiated and conducted interference from Information Technology (IT) equipment. The objective of the standard is to minimize the level of emissions both conducted and radiated.

For ease of measurement and analysis, conducted emissions are assumed to predominate below 30 MHz and radiated emissions are assumed to predominate above 30 MHz.

CONDUCTED EMISSIONS

This is a measure of noise which gets conducted onto the line power supply. Switching transients from the charge pump which are 20 V in magnitude and containing significant energy can lead to conducted emissions. Other sources of conducted emissions can be due to overlap in switch on-times in the charge pump voltage converter. In the voltage doubler shown below, if S2 has not fully turned off before S4 turns on, this results in a transient current glitch between V_{CC} and GND which results in conducted emissions. It is therefore important that the switches in the charge pump guarantee break-before-make switching under all conditions so that instantaneous short circuit conditions do not occur.

The ADM2xxE has been designed to minimize the switching transients and ensure break-before-make switching thereby minimizing conducted emissions. This has resulted in the level of emissions being well below the limits required by the specification. No additional filtering/decoupling other than the recommended 0.1 μF capacitor is required.

Conducted emissions are measured by monitoring the line power supply. The equipment used consists of a LISN (Line Impedance Stabilizing Network) which essentially presents a fixed impedance at RF, and a spectrum analyzer. The spectrum analyzer scans for emissions up to 30 MHz and a plot for the ADM211E is shown in Figure 32.

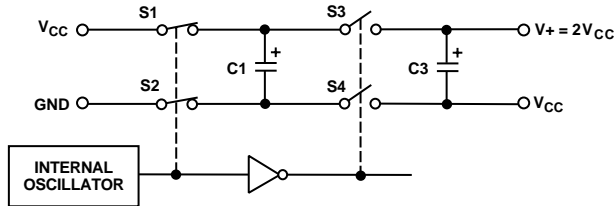

Figure 30. Charge Pump Voltage Doubler

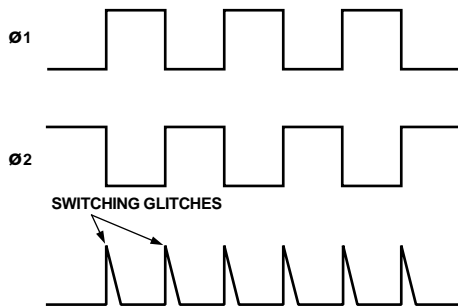

Figure 31. Switching Glitches

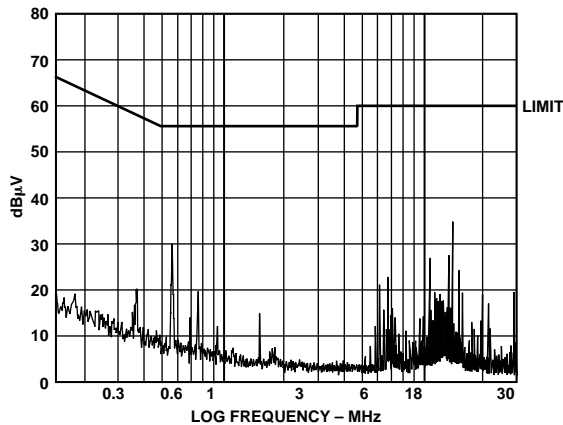

Figure 32. Conducted Emissions Plot

RADIATED EMISSIONS

Radiated emissions are measured at frequencies in excess of 30 MHz. RS-232 outputs designed for operation at high baud rates while driving cables can radiate high frequency EM energy. The reasons already discussed which cause conducted emissions can also be responsible for radiated emissions. Fast RS-232 output transitions can radiate interference, especially when lightly loaded and driving unshielded cables. Charge pump devices are also prone to radiating noise due to the high frequency oscillator and high voltages being switched by the charge pump. The move towards smaller capacitors in order to conserve board space has resulted in higher frequency oscillators being employed in the charge pump design. This has resulted in higher levels of emission, both conducted and radiated.

The RS-232 outputs on the ADM2xxE products feature a controlled slew rate in order to minimize the level of radiated emissions, yet are fast enough to support data rates up to 230 kBaud.

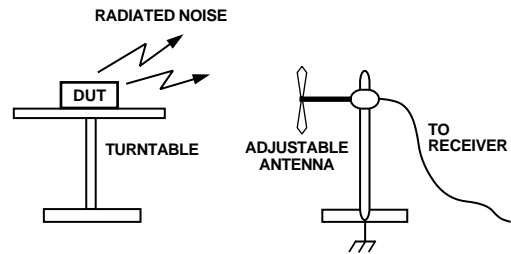

Figure 33. Radiated Emissions Test Setup

Figure 34 shows a plot of radiated emissions vs. frequency. This shows that the levels of emissions are well within specifications without the need for any additional shielding or filtering components. The ADM2xxE was operated at maximum baud rates and configured as in a typical RS-232 interface.

Testing for radiated emissions was carried out in a shielded anechoic chamber.

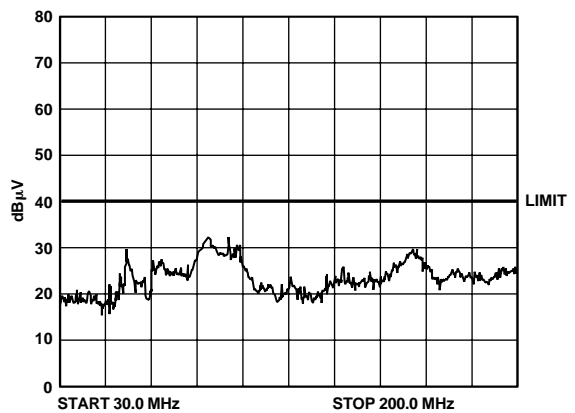

Figure 34. Radiated Emissions Plot

ADM206E/ADM207E/ADM208E/ADM211E/ADM213E

OUTLINE DIMENSIONS

Dimensions shown in inches and (mm).

24-Lead DIP (N-24)

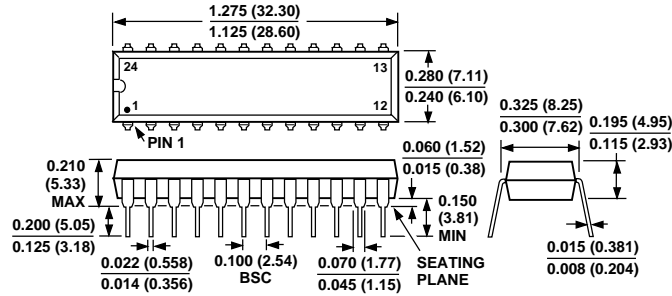

24-Lead SOIC (R-24)

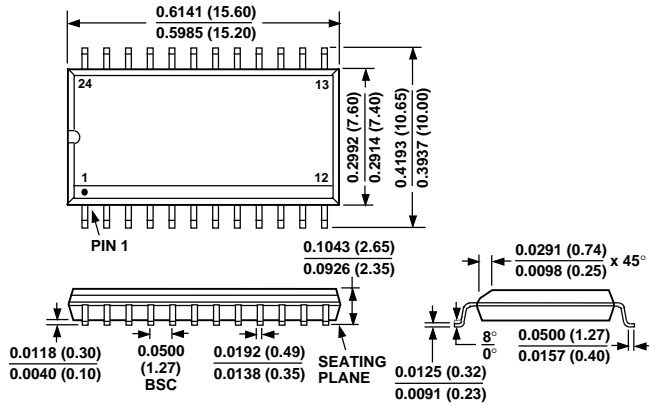

28-Lead SOIC (R-28)

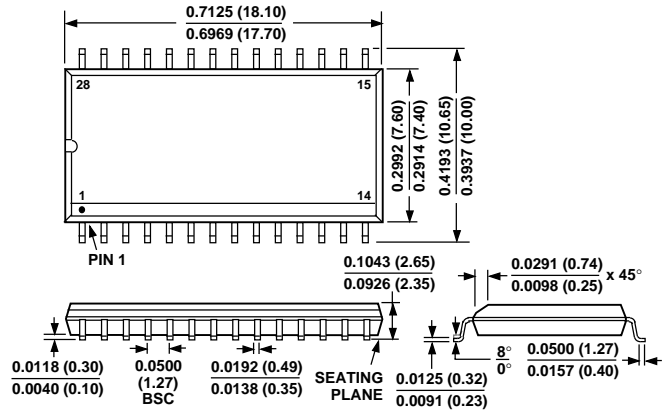

24-Lead SSOP (RS-24)

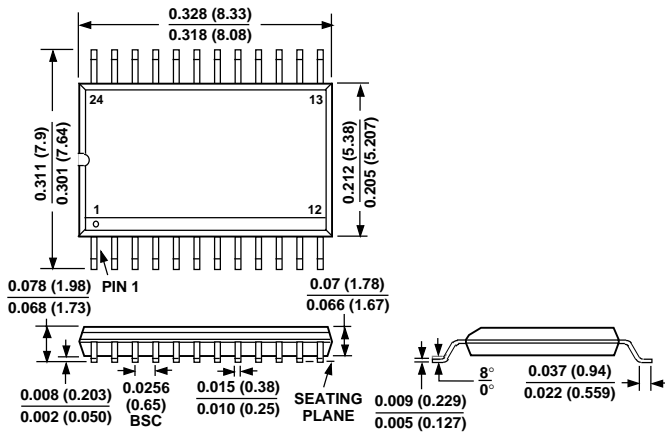

28-Lead SSOP (RS-28)

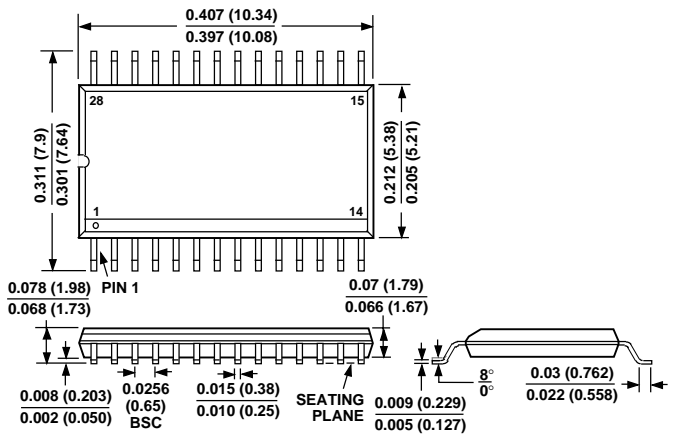

ADM206E/ADM207E/ADM208E/ADM211E/ADM213E

OUTLINE DIMENSIONS

Dimensions shown in inches and (mm).

24-Lead TSSOP (RU-24)

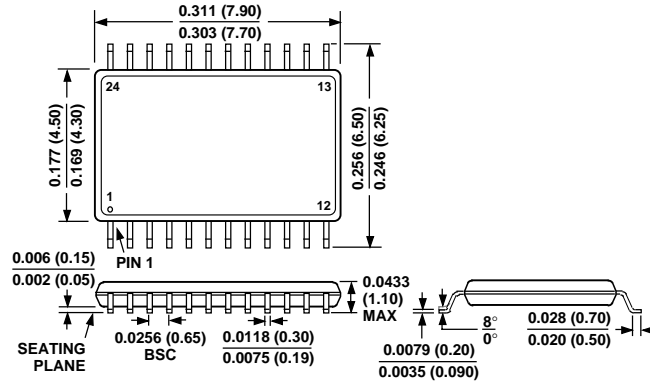

28-Lead TSSOP (RU-28)

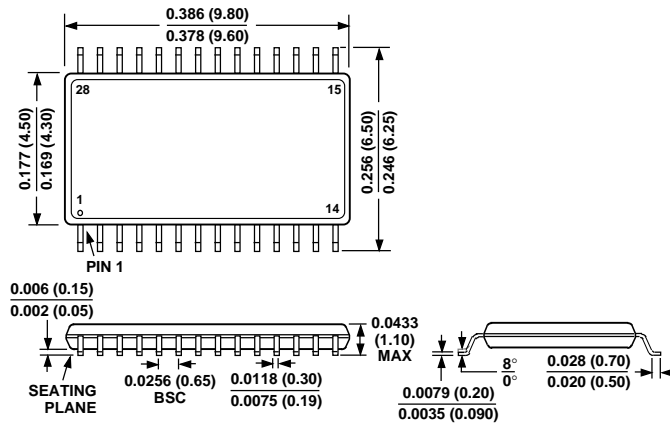

C3401-2.5-8/98

PRINTED IN U.S.A.

