

FEATURES

- Complete rate gyroscope on a single chip
- Z-axis (yaw rate) response
- High vibration rejection over wide frequency
- 0.05°/s/√Hz noise
- 2000 g powered shock operation
- Self-test on digital command
- Temperature sensor output
- Precision voltage reference output
- Absolute rate output for precision applications
- 5 V single-supply operation
- Ultrasmall and light (< 0.15 cc, < 0.5 gram)

APPLICATIONS

- GPS navigation systems
- Vehicle stability control
- Inertial measurement units
- Guidance and control
- Platform stabilization

GENERAL DESCRIPTION

The ADXRS150 is a complete angular rate sensor (gyroscope) that uses Analog Devices' surface-micromachining process to make a functionally complete and low cost angular rate sensor integrated with all of the required electronics on one chip.

The manufacturing technique for this device is the same high volume BIMOS process used for high reliability automotive airbag accelerometers.

The output signal, RATEOUT (1B, 2A), is a voltage proportional to the angular rate about the axis normal to the top surface of the package (see Figure 2). A single external resistor can be used to lower the scale factor. An external capacitor is used to set the bandwidth. Other external capacitors are required for operation (see Figure 21).

A precision reference and a temperature output are also provided for compensation techniques. Two digital self-test inputs electromechanically excite the sensor to test the operation of both sensors and the signal conditioning circuits. The ADXRS150 is available in a 7 mm × 7 mm × 3 mm BGA surface-mount package.

FUNCTIONAL BLOCK DIAGRAM

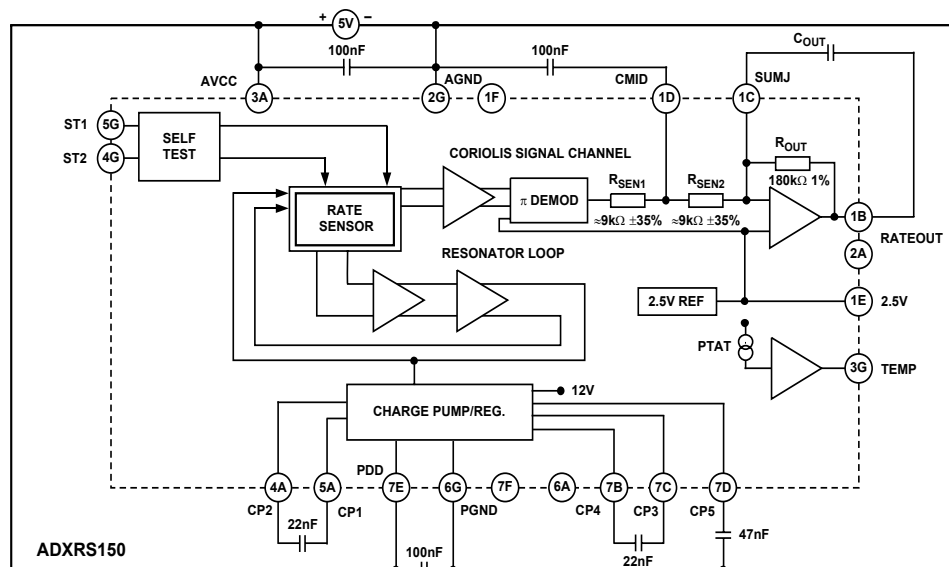

Figure 1.

Rev. A

Information furnished by Analog Devices is believed to be accurate and reliable. However, no responsibility is assumed by Analog Devices for its use, nor for any infringements of patents or other rights of third parties that may result from its use. Specifications subject to change without notice. No license is granted by implication or otherwise under any patent or patent rights of Analog Devices. Trademarks and registered trademarks are the property of their respective companies.

ADXRS150

TABLE OF CONTENTS

ADXRS150—Specifications	3	Temperature Output and Calibration.....	9
Absolute Maximum Ratings.....	4	Using the ADXRS150 with a Supply-Ratiometric ADC	9
Rate Sensitive Axis.....	4	Null Adjustment	9
Typical Performance Characteristics	5	Self-Test Function	9
Theory of Operation	8	Continuous Self-Test.....	9
Supply and Common Considerations	8	Acceleration Sensitivity	10
Setting Bandwidth	8	Pin Configurations And Functional Descriptions	11
Increasing Measurement Range	9	Outline Dimensions	12

REVISION HISTORY

Revision A

1/03—Data Sheet Changed from REV. 0 to REV. A

Edit to Figure 5..... 5

ADXRS150—SPECIFICATIONS

Table 1. @T_A = 25°C, V_S = 5 V, Bandwidth = 80 Hz (C_{OUT} = 0.01 μF), Angular Rate = 0°/s, Unless Otherwise Noted.

Parameter	Conditions	ADXRS150ABG			Unit
		Min ¹	Typ	Max ¹	
SENSITIVITY					
Dynamic Range ²	Clockwise Rotation Is Positive Output Full-Scale Range over Specifications Range	±150			°/s
Initial	@25°C	11.25	12.5	13.75	mV/°/s
Over Temperature ³	V _{CC} = 4.75 V to 5.25 V	11.25		13.75	mV/°/s
Nonlinearity	Best Fit Straight Line		0.1		% of FS
Voltage Sensitivity	V _{CC} = 4.75 V to 5.25 V		0.7		%/V
NULL					
Initial Null			2.50		V
Null Drift over Temperature ³	Delta from 25°C			±300	mV
Turn-On Time	Power on to ±½°/s of Final		35		ms
Linear Acceleration Effect	Any Axis		0.2		°/s/g
Voltage Sensitivity	V _{CC} = 4.75 V to 5.25 V		1		°/s/V
NOISE PERFORMANCE					
Rate Noise Density	@25°C		0.05		°/s/√Hz
FREQUENCY RESPONSE					
3 db Bandwidth ⁴ (User Selectable)	22 nF as Comp Cap (See Applications section)		40		Hz
Sensor Resonant Frequency			14		kHz
SELF TEST					
ST1 RATEOUT Response ⁵	ST1 Pin from Logic "0" to "1," -40°C to +85°C	-400	-660	-1000	mV
ST2 RATEOUT Response ⁵	ST2 Pin from Logic "0" to "1," -40°C to +85°C	+400	+660	+1000	mV
Logic "1" Input Voltage	Standard High Logic Level Definition	3.3			V
Logic "0" Input Voltage	Standard Low Logic Level Definition			1.7	V
Input Impedance	To Common		50		kΩ
TEMPERATURE SENSOR					
V _{OUT} at 298°K			2.50		V
Max Current Load on Pin	Source to Common			50	μA
Scale Factor	Proportional to Absolute Temperature		8.4		mV/°K
OUTPUT DRIVE CAPABILITY					
Output Voltage Swing	I _{OUT} = ±100 μA	0.25		V _S - 0.25	V
Capacitive Load Drive		1000			pF
2.5 V REFERENCE					
Voltage Value		2.45	2.5	2.55	V
Load Drive to Ground	Source		200		μA
Load Regulation	0 < I _{OUT} < 200 μA		5.0		mV/mA
Power Supply Rejection	4.75 V _S to 5.25 V _S		1.0		mV/V
Temperature Drift ³	Delta from 25°C		5.0		mV
POWER SUPPLY					
Operating Voltage Range		4.75	5.00	5.25	V
Quiescent Supply Current			6.0	8.0	mA
TEMPERATURE RANGE					
Specified Performance Grade A		-40		+85	°C

¹ All min and max specifications are guaranteed. Typical specifications are not tested or guaranteed.

² Dynamic range is the maximum full-scale measurement range possible, including output swing range, initial offset, sensitivity, offset drift, and sensitivity drift at 5 V supplies.

³ Specification refers to the maximum extent of this parameter as a worst-case value at T_{MIN} or T_{MAX}.

⁴ Frequency at which response is 3 dB down from dc response with specified compensation capacitor value. Internal pole forming resistor is 180 kΩ. See Setting Bandwidth section.

⁵ Self-test response varies with temperature. Refer to the Self-Test Function section for details.

ADXRS150

ABSOLUTE MAXIMUM RATINGS

Table 2. ADXRS150 Absolute Maximum Ratings

Parameter	Rating
Acceleration (Any Axis, Unpowered, 0.5 ms)	2000 g
Acceleration (Any Axis, Powered, 0.5 ms)	2000 g
+V _s	-0.3 V to +6.0 V
Output Short-Circuit Duration (Any Pin to Common)	Indefinite
Operating Temperature Range	-55°C to +125°C
Storage Temperature	-65°C to +150°C

Stresses above those listed under Absolute Maximum Ratings may cause permanent damage to the device. This is a stress rating only and functional operation of the device at these or any other conditions above those indicated in the operational section of this specification is not implied. Exposure to absolute maximum rating conditions for extended periods may affect device reliability.

Applications requiring more than 200 cycles to MIL-STD-883 Method 1010 Condition B (-55°C to +125°C) require underfill or other means to achieve this requirement.

Drops onto hard surfaces can cause shocks of greater than 2000 g and exceed the absolute maximum rating of the device. Care should be exercised in handling to avoid damage.

Rate Sensitive Axis

This is a Z-axis rate-sensing device that is also called a yaw-rate sensing device. It produces a positive going output voltage for clockwise rotation about the axis normal to the package top, i.e., clockwise when looking down at the package lid.

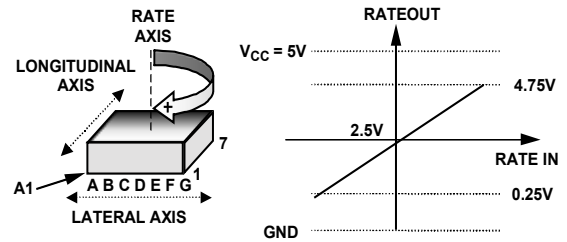

Figure 2. RATEOUT Signal Increases with Clockwise Rotation

TYPICAL PERFORMANCE CHARACTERISTICS

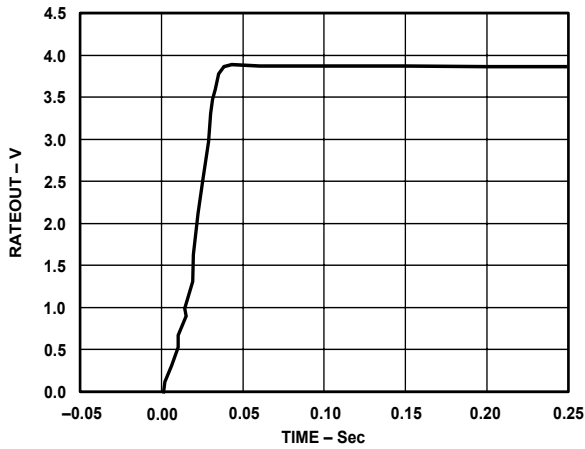

Figure 3. Rate Sensing Start-Up Time

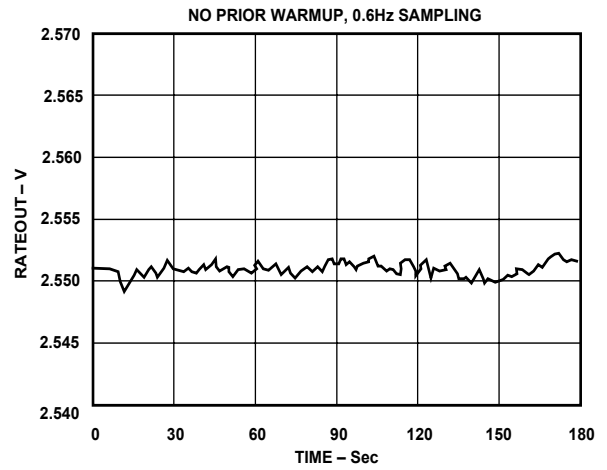

Figure 6. Null Settling Time

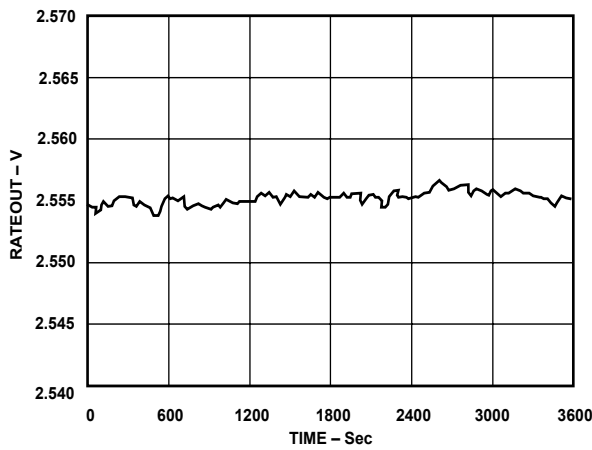

Figure 4. Null Stability for 1 Hour

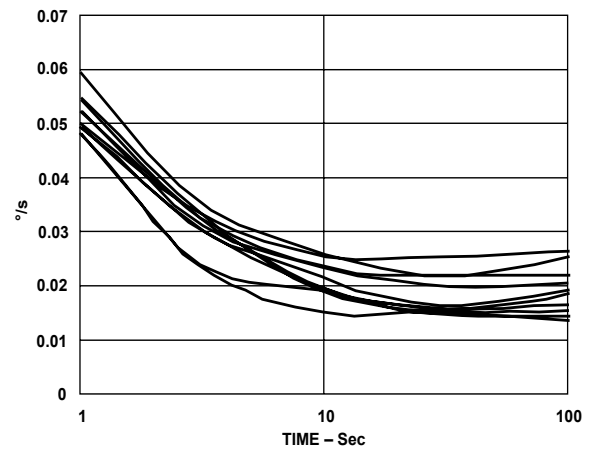

Figure 7. Root Allan Variance vs. Averaging Time

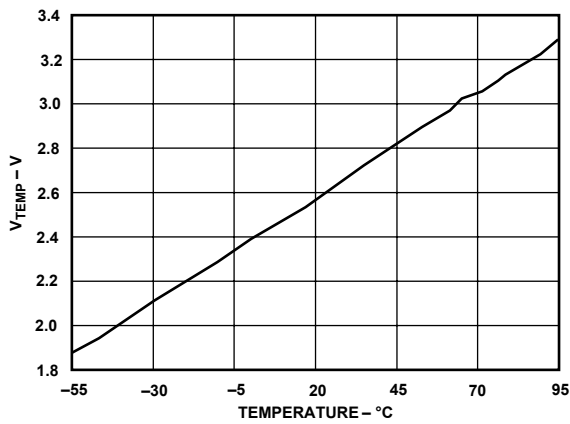

Figure 5. Temperature Sensor Output

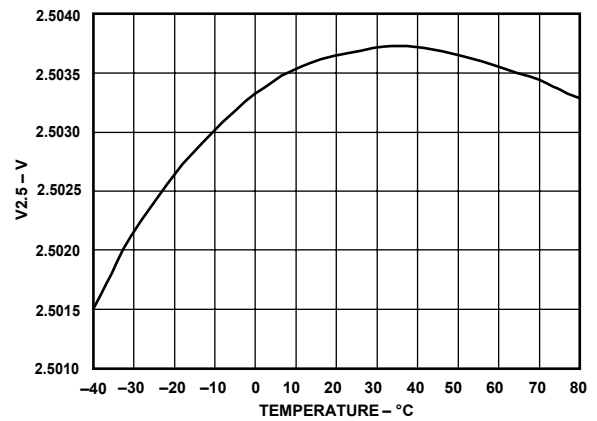

Figure 8. 2.5 V Voltage Reference vs. Temperature

ADXRS150

ADXRS150 @ BW = 40 Hz, Typical Vibration Characteristics, 10 g Flat Band, 20 Hz to 2 kHz

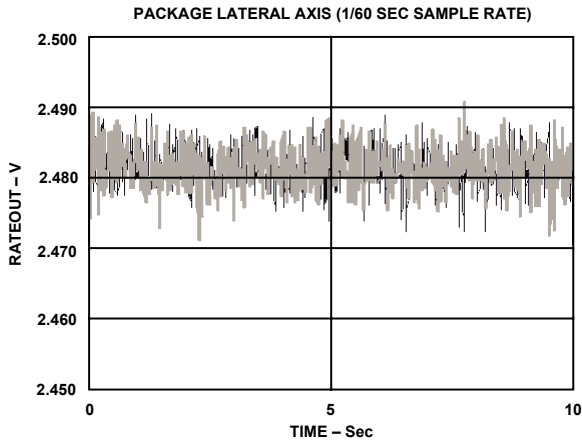

Figure 9. 10 g Random Vibration in Package-Lateral Axis Orientation

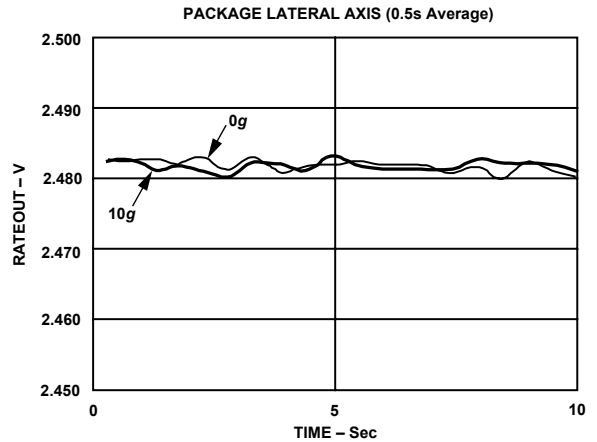

Figure 12. 10 g Random Vibration in Package-Lateral Axis Orientation

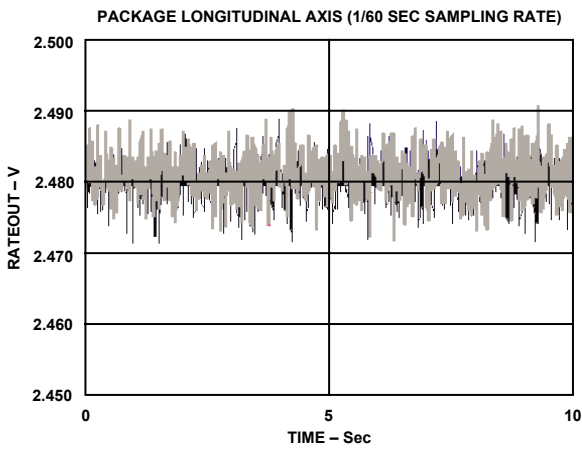

Figure 10. 10 g Random Vibration in Package-Longitudinal Axis Orientation

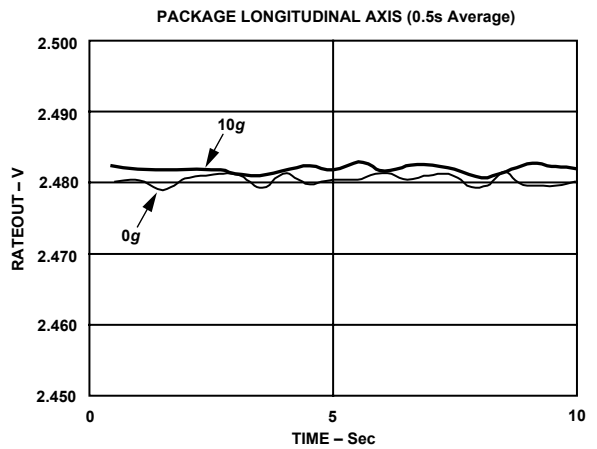

Figure 13. 10 g Random Vibration in Package-Longitudinal Axis Orientation

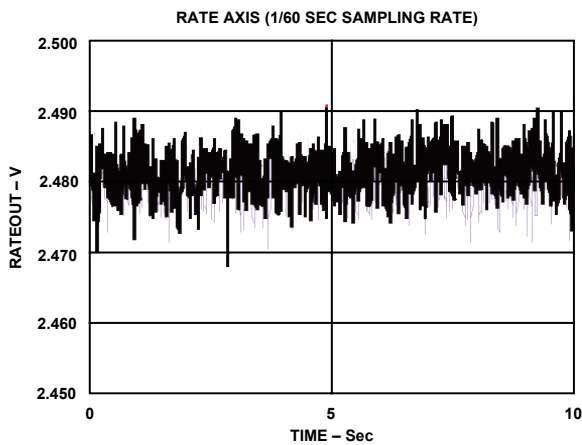

Figure 11. 10 g Random Vibration in Rate Axis Orientation

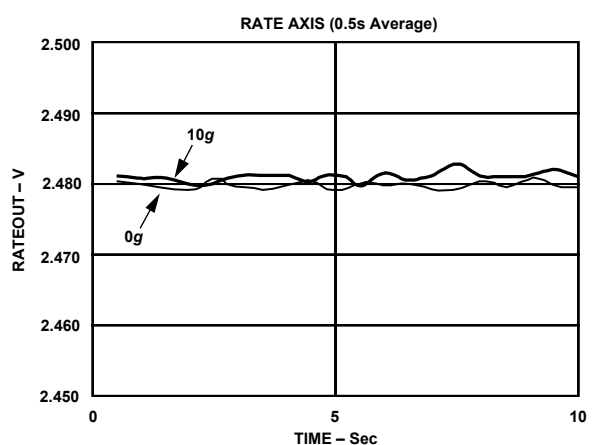

Figure 14. 10 g Random Vibration in Rate Axis Orientation

Behavior under Various Shock Test Conditions

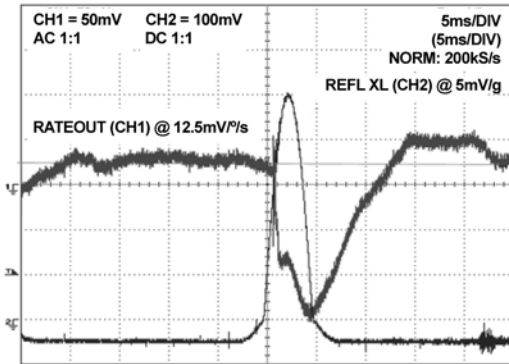

Figure 15. Shock Test 100 g, 5 ms in Lateral Axis (40 Hz)

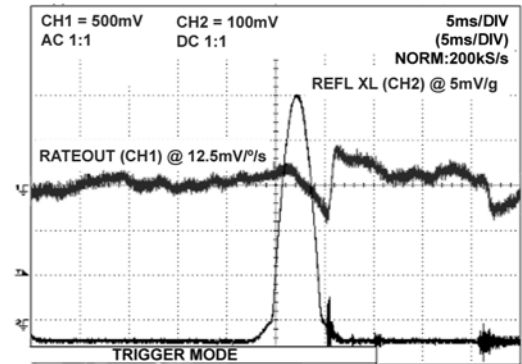

Figure 18. Shock Test 100 g, 5 ms in Longitudinal Axis (40 Hz)

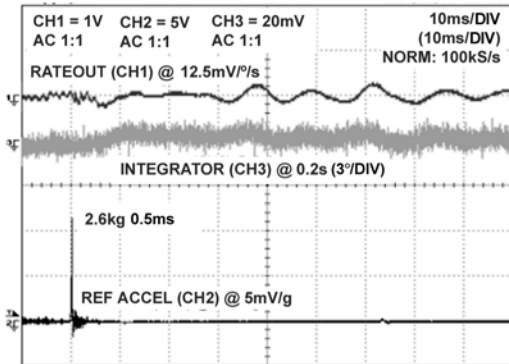

Figure 16. Hi-g Shock Test in Lateral Axis (40 Hz)

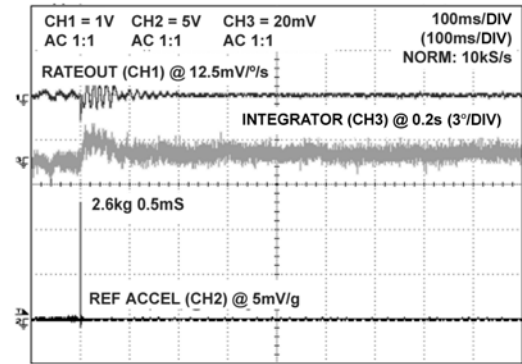

Figure 19. Hi-g Shock Test, Lateral Axis, 10x Time Base (40 Hz)

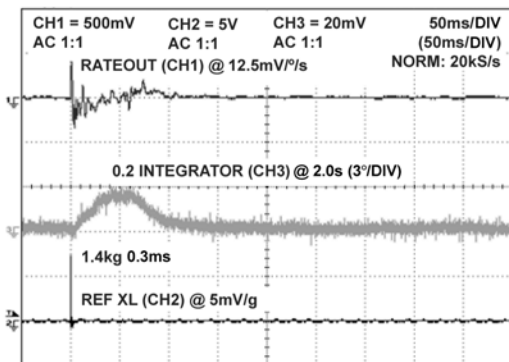

Figure 17. Hi-g Shock in Rate Axis (40 Hz)

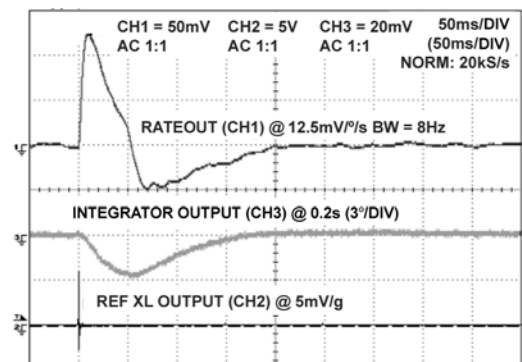

Figure 20. Hi-g Shock, Rate Axis, BW Reduced to 8 Hz

ADXRS150

THEORY OF OPERATION

The ADXRS150 operates on the principle of a resonator gyro. Two polysilicon sensing structures each contain a dither frame, which is electrostatically driven to resonance. This produces the necessary velocity element to produce a Coriolis force during angular rate. At two of the outer extremes of each frame, orthogonal to the dither motion, are movable fingers that are placed between fixed pickoff fingers to form a capacitive pickoff structure that senses Coriolis motion. The resulting signal is fed to a series of gain and demodulation stages that produce the electrical rate signal output. The dual-sensor design rejects external g-forces and vibration. Fabricating the sensor with the signal conditioning electronics preserves signal integrity in noisy environments.

The electrostatic resonator requires 14 V to 16 V for operation. Since only 5 V is typically available in most applications, a charge pump is included on-chip. If an external 14 V to 16 V supply is available, the two capacitors on CP1–CP4 can be omitted and this supply can be connected to CP5 (Pin 7D) with a 100 nF decoupling capacitor in place of the 47 nF.

After the demodulation stage there is a single-pole low-pass filter consisting of an internal 9 kΩ resistor (R_{SEN1}) and an external user-supplied capacitor (CMID). A CMID capacitor of 100 nF sets a 400 Hz $\pm 35\%$ low-pass pole and is used to limit high frequency artifacts before final amplification. Bandwidth limit capacitor, C_{OUT} , sets the pass bandwidth (see Figure 22 and the Setting Bandwidth section).

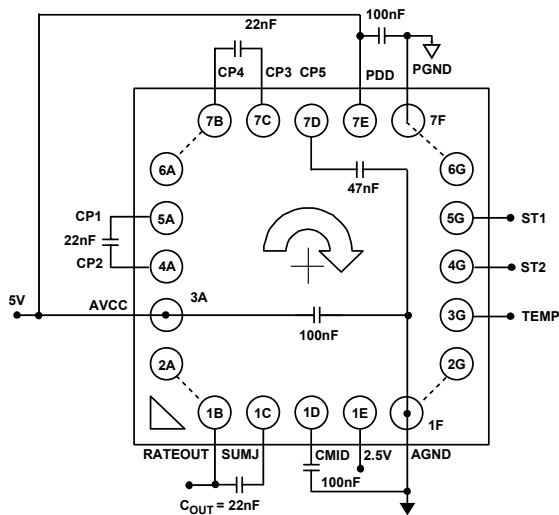

NOTE THAT INNER ROWS/COLUMNS OF PINS HAVE BEEN OMITTED FOR CLARITY BUT SHOULD BE CONNECTED IN THE APPLICATION.

Figure 21. Example Application Circuit (Top View)

Supply and Common Considerations

Only power supplies used for supplying analog circuits are recommended for powering the ADXRS150. High frequency noise

and transients associated with digital circuit supplies may have adverse effects on device operation.

Figure 21 shows the recommended connections for the ADXRS150 where both AVCC and PDD have a separate decoupling capacitor. These should be placed as close to their respective pins as possible before routing to the system analog supply. This will minimize the noise injected by the charge pump that uses the PDD supply.

It is also recommended to place the charge pump capacitors connected to the CP1–CP4 pins as close to the part as possible. These capacitors are used to produce the on-chip high voltage supply switched at the dither frequency at approximately 14 kHz. Care should be taken to ensure that there is no more than 50 pF of stray capacitance between CP1–CP4 and ground. Surface-mount chip capacitors are suitable as long as they are rated for over 15 V.

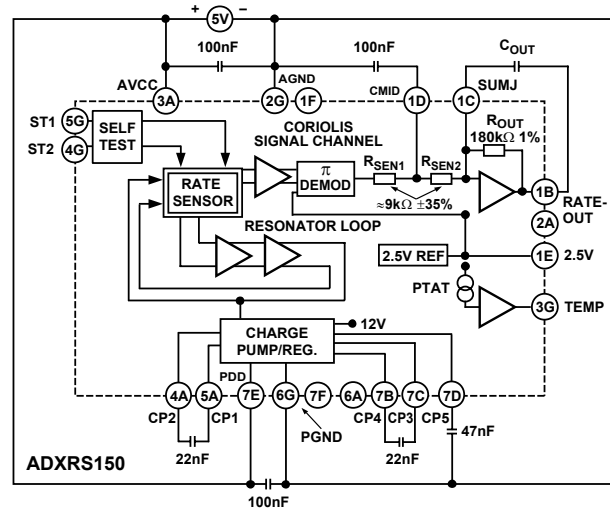

Figure 22. Block Diagram with External Components

Setting Bandwidth

External capacitors CMID and C_{OUT} are used in combination with on-chip resistors to create two low-pass filters to limit the bandwidth of the ADXRS150's rate response. The -3 dB frequency set by R_{OUT} and C_{OUT} is:

$$f_{OUT} = 1 / (2 \times \pi \times R_{OUT} \times C_{OUT})$$

and can be well controlled since R_{OUT} has been trimmed during manufacturing to be $180 \text{ k}\Omega \pm 1\%$. Any external resistor applied between the RATEOUT (1B, 2A) and SUMJ (1C, 2C) pins will result in:

$$R_{OUT} = (180 \text{ k}\Omega \times R_{EXT}) / (180 \text{ k}\Omega + R_{EXT})$$

The -3 dB frequency is set by RSEN (the parallel combination

of R_{SEN1} and R_{SEN2}) at about 4.5 k Ω nominal, and CMID is less well controlled since R_{SEN1} and R_{SEN2} have been used to trim the rate sensitivity during manufacturing and have a $\pm 35\%$ tolerance. Its primary purpose is to limit the high frequency demodulation artifacts from saturating the final amplifier stage. Thus, this pole of nominally 400 Hz @ 0.1 μ F need not be precise. Lower frequency is preferable, but its variability usually requires it to be about 10 times greater (in order to preserve phase integrity) than the well-controlled output pole. In general, both -3 dB filter frequencies should be set as low as possible to reduce the amplitude of these high frequency artifacts as well as to reduce the overall system noise.

Increasing Measurement Range

The full-scale measurement range of the ADXRS150 can be increased by placing an external resistor between the RATEOUT (1B, 2A) and SUMJ (1C, 2C) pins, which would parallel the internal R_{OUT} resistor that is factory-trimmed to 180 k Ω . For example, a 330 k Ω external resistor will give approximately 8.1 mV/ $^\circ$ /sec sensitivity and a commensurate $\sim 50\%$ increase in the full-scale range. This is effective for up to a 4 \times increase in the full-scale range (minimum value of the parallel resistor allowed is 45 k Ω). Beyond this amount of external sensitivity reduction, the internal circuitry headroom requirements prevent further increase in the linear full-scale output range. The drawbacks of modifying the full-scale range are the additional output null drift (as much as 2 $^\circ$ /sec over temperature) and the readjustment of the initial null bias (see the Null Adjust section).

Temperature Output and Calibration

It is common practice to temperature-calibrate gyros to improve their overall accuracy. The ADXRS150 has a temperature-proportional voltage output that provides input to such a calibration method. The voltage at TEMP (3F, 3G) is nominally 2.5 V at 27 $^\circ$ C and has a PTAT (proportional to absolute temperature) characteristic of 8.4 mV/ $^\circ$ C. Note that the TEMP output circuitry is limited to 50 μ A source current.

Using a 3-point calibration technique, it is possible to calibrate the ADXRS150's null and sensitivity drift to an overall accuracy of nearly 300 $^\circ$ /hour. An overall accuracy of 70 $^\circ$ /hour or better is possible using more points. Limiting the bandwidth of the device reduces the flat-band noise during the calibration process, improving the measurement accuracy at each calibration point.

Using the ADXRS150 with a Supply-Ratiometric ADC

The ADXRS150's RATEOUT signal is nonratiometric, i.e., neither the null voltage nor the rate sensitivity is proportional to the supply. Instead they are nominally constant for dc supply

changes within the 4.75 V to 5.25 V operating range. If the ADXRS150 is used with a supply-ratiometric ADC, the ADXRS150's 2.5 V output can be converted and used to make corrections in software for the supply variations.

Null Adjustment

Null adjustment is possible by injecting a suitable current to SUMJ (1C, 2C). Adding a suitable resistor to either ground or the positive supply is a simple way of achieving this. The nominal 2.5 V null is for a symmetrical swing range at RATEOUT (1B, 2A). However, a nonsymmetric output swing may be suitable in some applications. Note that if a resistor is connected to the positive supply, supply disturbances may reflect some null instability. Digital supply noise should be avoided particularly in this case (see Supply and Common Considerations section).

The resistor value to use is approximately:

$$R_{NULL} = (2.5 \times 180,000) / (V_{NULL0} - V_{NULL1})$$

V_{NULL0} is the unadjusted zero rate output, and V_{NULL1} is the target null value. If the initial value is below the desired value, the resistor should terminate on common or ground. If it is above the desired value, the resistor should terminate on the 5 V supply. Values typically are in the 1 M Ω to 5 M Ω range.

If an external resistor is used across RATEOUT and SUMJ, then the parallel equivalent value is substituted into the above equation. Note that the resistor value is an estimate since it assumes $V_{CC} = 5.0$ V and $V_{SUMJ} = 2.5$ V.

Self-Test Function

The ADXRS150 includes a self-test feature that actuates each of the sensing structures and associated electronics in the same manner as if subjected to angular rate. It is activated by standard logic high levels applied to inputs ST1 (5F, 5G), ST2 (4F, 4G), or both. ST1 will cause the voltage at RATEOUT to change about -0.66 V and ST2 will cause an opposite change of $+0.66$ V. The self-test response follows the viscosity temperature dependence of the package atmosphere, approximately 0.25%/ $^\circ$ C.

Activating both ST1 and ST2 simultaneously is not damaging. Since ST1 and ST2 are not necessarily closely matched, actuating both simultaneously may result in an apparent null bias shift.

Continuous Self-Test

The one-chip integration of the ADXRS150 gives it higher reliability than is obtainable with any other high volume manufacturing method. Also, it is manufactured under a mature BIMOS process that has field-proven reliability. As an additional failure detection measure, power-on self-test can be performed. However, some applications may warrant continuous self-test while

ADXRS150

sensing rate. Application notes outlining continuous self-test techniques are also available on the Analog Devices website.

Acceleration Sensitivity

The sign convention used is that lateral acceleration is positive in the direction from Pin Column A to Pin Column G of the package. That is, a device has positive sensitivity if its voltage output increases when the row of Pins 2A–6A are tipped under the row of Pins 2G–6G in the earth's gravity.

There are two effects of concern, shifts in the static null and induced null noise. Scale factor is not significantly affected until the acceleration reaches several hundred m/s^2 .

Vibration rectification for frequencies up to 20 kHz is on the order of $0.00002(^{\circ}/s)/(m/s^2)$, is not significantly dependent on frequency, and has been verified up to 400 m/s^2 rms.

Linear vibration spectral density near the 14 kHz sensor resonance translates into output noise. In order to have a significant effect, the vibration must be within the angular rate bandwidth (typically ± 40 Hz of the resonance), so it takes considerable high frequency vibration to have any effect.

Away from the 14 kHz resonance the effect is not discernible, except for vibration frequencies within the angular rate pass band. This can be seen in Figure 9 to Figure 14 for the various sensor axes. The in-band effect can be seen in Figure 24. This is the result of the static g -sensitivity. The specimen used for Figure 24 had a g -sensitivity of $0.15^{\circ}/s/g$ and its total in-band noise degraded from 3 mV rms to 5 mV rms for the specified vibration. The effect of broadband vibration up to 20 kHz is shown in Figure 23 and Figure 25.

The output noise of the part falls away in accordance with the output low-pass filter and does not contain any “spikes” greater than 1% of the low frequency noise. A typical noise spectrum is shown in Figure 26.

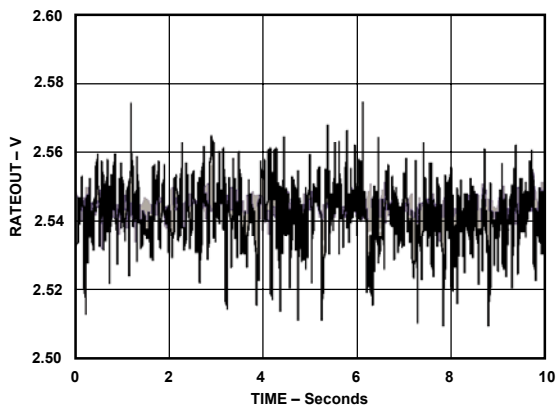

Figure 23. Random Vibration (Lateral) 10 kHz to 20 kHz at $0.01 g/\sqrt{Hz}$ with 60 Hz Sampling and 0.5 Sec Averaging

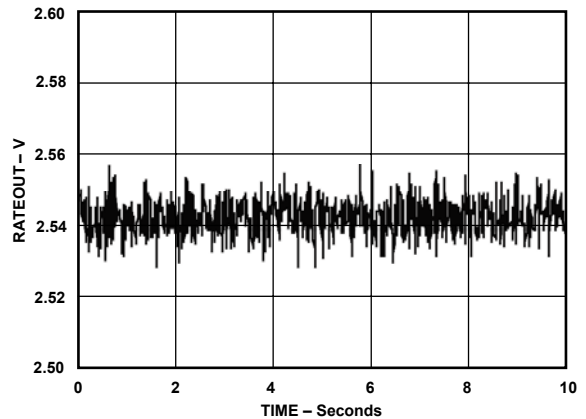

Figure 24. Random Vibration (Lateral) 2 Hz to 40 Hz, 3.2 g rms

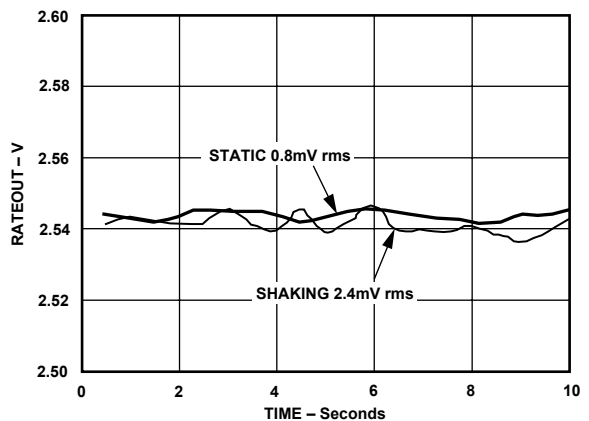

Figure 25. Random Vibration (Lateral) 10 kHz to 20 kHz at $0.01 g/\sqrt{Hz}$ with 60 Hz Sampling and 0.5 Sec Averaging

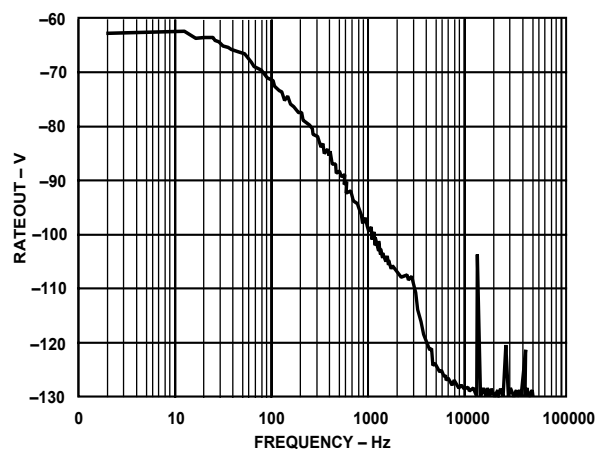

Figure 26. Noise Spectral Density at RATEOUT - BW = 4Hz

PIN CONFIGURATIONS AND FUNCTIONAL DESCRIPTIONS

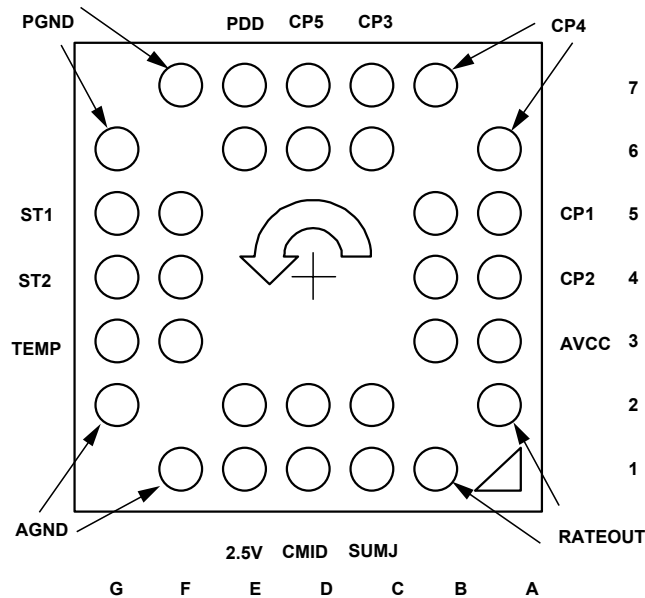

Figure 27. BGA-32 (Bottom View)

Table 3. Pin Function Descriptions—32-Lead BGA

Pin No.	Mnemonic	Description
6D, 7D	CP5	HV Filter Capacitor—47 nF
6A, 7B	CP4	Charge Pump Capacitor—22 nF
6C, 7C	CP3	
5A, 5B	CP1	Charge Pump Capacitor—22 nF
4A, 4B	CP2	
3A, 3B	AVCC	+ Analog Supply
1B, 2A	RATEOUT	Rate Signal Output
1C, 2C	SUMJ	Output Amp Summing Junction
1D, 2D	CMID	HF Filter Capacitor—100 nF
1E, 2E	2.5V	2.5 V Precision Reference
1F, 2G	AGND	Analog Supply Return
3F, 3G	TEMP	Temperature Voltage Output
4F, 4G	ST2	Self-Test for Sensor 2
5F, 5G	ST1	Self-Test for Sensor 1
6G, 7F	PGND	Charge Pump Supply Return
6E, 7E	PDD	+ Charge Pump Supply

ADXRS150

OUTLINE DIMENSIONS

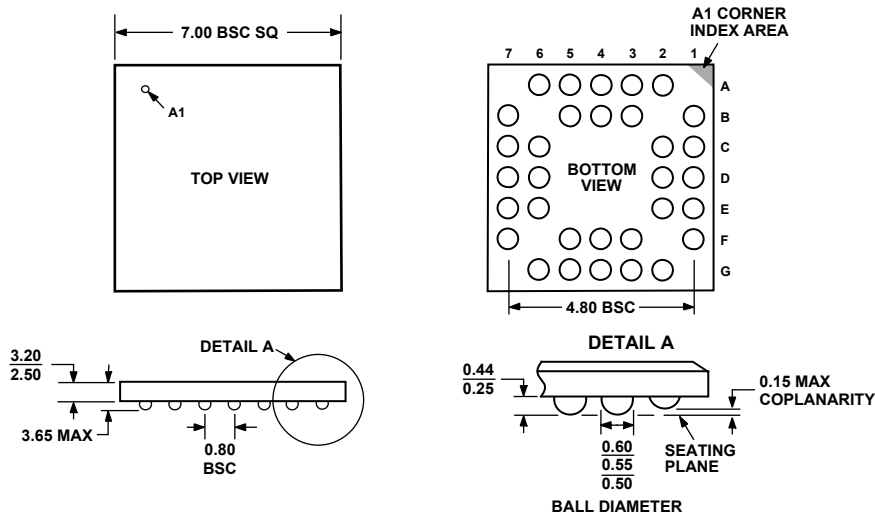

Figure 28. 32-Lead Chip Scale Ball Grid Array [CSPBGA]
(BC-32)
Dimensions shown in millimeters

ESD CAUTION

ESD (electrostatic discharge) sensitive device. Electrostatic charges as high as 4000 V readily accumulate on the human body and test equipment and can discharge without detection. Although this product features proprietary ESD protection circuitry, permanent damage may occur on devices subjected to high energy electrostatic discharges. Therefore, proper ESD precautions are recommended to avoid performance degradation or loss of functionality.



Table 4. Ordering Guide

ADXRS150 Products	Temperature Package	Package Description	Package Outline
ADXRS150ABG	-40°C to +85°C	32-Lead BGA	BC-32
ADXRS150ABG-Reel	-40°C to +85°C	32-Lead BGA	BC-32