

7MBP50RTB060

IPM-R3 series

600V / 50A 7 in one-package

Features

- Temperature protection provided by directly detecting the junction temperature of the IGBTs
- Low power loss and soft switching
- High performance and high reliability IGBT with overheating protection
- Higher reliability because of a big decrease in number of parts in built-in control circuit

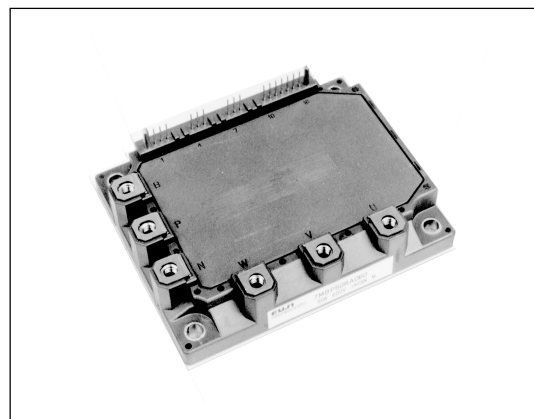

Maximum ratings and characteristics

- Absolute maximum ratings(at Tc=25°C unless otherwise specified)

Item	Symbol	Rating		Unit		
		Min.	Max.			
Bus voltage (between terminal P and N)	DC	Vdc	0	450	V	
	Surge	VDC(surge)	0	500	V	
	Shortoperating	Vsc	200	400	V	
Collector-Emitter voltage	VCES *1	0	600	V		
Inverter	Collector current	DC	Ic	-	50	A
		1ms	ICP	-	100	A
		Duty=76.1%	-Ic *2	-	50	A
Collector power dissipation	One transistor	PC *3	-	144	W	
Brake	Collector current	DC	Ic	-	30	A
		1ms	ICP	-	60	A
	Forward Current of Diode	IF	-	30	A	
Collector power dissipation	One transistor	PC *3	-	144	W	
Input voltage of power supply for Pre-Driver	Vcc *4	-0.5	20	V		
Input signal voltage	Vin *5	-0.5	Vcc+0.5	V		
Input signal current	Iin	-	3	mA		
Alarm signal voltage	VALM *6	-0.5	Vcc	V		
Alarm signal current	IALM *7	-	20	mA		
Junction temperature	Tj	-	150	°C		
Operating case temperature	Tcp	-20	100	°C		
Storage temperature	Tsig	-40	125	°C		
Isolating voltage (Case-Terminal)	Viso *8	-	AC2.5	kV		
Screw torque	Mounting (M5)	-	3.5 *9	N·m		
	Terminal (M5)	-	3.5 *9	N·m		

Note

- *1 : Vces shall be applied to the input voltage between terminal P and U or V or W or DB, N and U or V or W or DB.
- *2 : $125^{\circ}\text{C}/\text{FWD Rth}(j-c)/(Ic \times V_F \text{ MAX})=125/1.263/(50 \times 2.6) \times 100=76.1\%$
- *3 : $Pc=125^{\circ}\text{C}/\text{IGBT Rth}(j-c)=125/0.87=144\text{W}$ [Inverter]
 $Pc=125^{\circ}\text{C}/\text{IGBT Rth}(j-c)=125/0.87=144\text{W}$ [Break]
- *4 : Vcc shall be applied to the input voltage between terminal No. 3 and 1, 6 and 4, 9 and 7, 11 and 10.
- *5 : Vin shall be applied to the input voltage between terminal No. 2 and 1, 5 and 4, 8 and 7, 12,13,14,15 and 10.
- *6 : VALM shall be applied to the voltage between terminal No. 16 and 10.
- *7 : IALM shall be applied to the input current to terminal No. 16.
- *8 : 50Hz/60Hz sine wave 1 minute.
- *9 : Recommendable Value : 2.5 to 3.0 N·m

Weight

Item	Symbol	Min.	Typ.	Max.	Unit
Weight	Wt	-	450	-	g

- *9 : (For 1 device, Case is under the device)

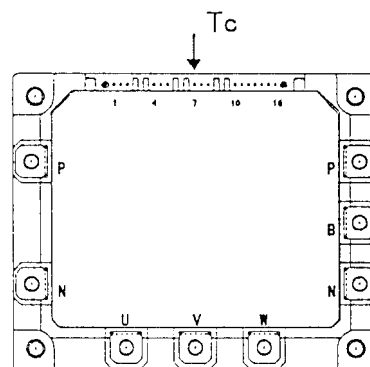

Fig.1 Measurement of case temperature

Electrical characteristics (at Tc=Tj=25°C, Vcc=15V unless otherwise specified.)

● Main circuit

Item		Symbol	Condition	Min.	Typ.	Max.	Unit	
Inverter	Collector current at off signal input	ICES	VCE=600V Vin terminal open.	-	-	1.0	mA	
	Collector-Emitter saturation voltage	VCE(sat)	Ic=50A	Terminal	-	-	2.5	V
				Chip	-	2.0	-	
	Forward voltage of FWD	VF	Ic=50A	Terminal	-	-	2.6	V
Chip				-	1.6	-		
Brake	Collector current at off signal input	ICES	VCE=600V Vin terminal open.	-	-	1.0	mA	
	Collector-Emitter saturation voltage	VCE(sat)	Ic=30A	Terminal	-	-	2.2	V
				Chip	-	1.75	-	
	Forward voltage of Diode	VF	-Ic=30A	Terminal	-	-	3.3	V
Chip				-	1.9	-		
Turn-on time	ton	VDC=300V, Tj=125°C		1.2	-	-	μs	
Turn-off time	toff	IC=50A Fig.1, Fig.6		-	-	3.6		
Reverse recovery time	trr	VDC=300V, IC=50A Fig.1, Fig.6		-	-	0.3		
Maximum Avalanche Energy (A non-repetition)	PAV	Internal wiring inductance=50nH Main circuit wiring inductance=54nH		30	-	-	mJ	

● Control circuit

Item	Symbol	Condition	Min.	Typ.	Max.	Unit
Supply current of P-line side pre-driver(one unit)	Iccp	Switching Frequency : 0 to 15kHz Tc=-20 to 125°C Fig.7	-	-	18	mA
Supply current of N-line side pre-driver	Iccn		-	-	65	mA
Input signal threshold voltage (on/off)	Vin(th)	ON	1.00	1.35	1.70	V
		OFF	1.25	1.60	1.95	V
Input zener voltage	Vz	Rin=20k ohm	-	8.0	-	V
Alarm signal hold time	tALM	Tc=-20°C Fig.2	1.1	-	-	ms
		Tc=25°C Fig.2	-	2.0	-	ms
		Tc=125°C Fig.2	-	-	4.0	ms
Limiting resistor for alarm	RALM		1425	1500	1575	ohm

● Protection Section (Vcc=15V)

Item	Symbol	Condition	Min.	Typ.	Max.	Unit
Over Current Protection Level of Inverter circuit	Ioc	Tj=125°C	75	-	-	A
Over Current Protection Level of brake circuit		Tj=125°C	45	-	-	A
Over Current Protection Delay time	tDOC	Tj=125°C	-	5	-	μs
SC Protection Delay time	tsc	Tj=125°C Fig.4	-	-	8	μs
IGBT Chip Over Heating	TjOH	surface of IGBT chips	150	-	-	°C
Over Heating Protection Hysteresis	TjH		-	20	-	°C
Over Heating Protection Temperature Level	TcOH	VDC=0V, Ic=0A, Case temperature	110	-	125	°C
Over Heating Protection Hysteresis	TcH		-	20	-	°C
Under Voltage Protection Level	VUV		11.0	-	12.5	V
Under Voltage Protection Hysteresis	VH		0.2	0.5	-	V

● Thermal characteristics(Tc=25°C)

Item	Symbol		Min.	Typ.	Max.	Unit	
Junction to Case thermal resistance	INV	IGBT	Rth(j-c)	-	-	0.87	°C/W
		FWD	Rth(j-c)	-	-	1.263	°C/W
	Brake	IGBT	Rth(j-c)	-	-	0.87	°C/W
Case to fin thermal resistance with compound	Rth(c-f)		-	0.05	-	°C/W	

● Noise Immunity (VDC=300V, Vcc=15V, Test Circuit Fig.5)

Item	Condition	Min.	Typ.	Max.	Unit
Common mode rectangular noise	Pulse width 1μs, polarity ±, 10minuets Judge : no over-current, no miss operating	±2.0	-	-	kV
Common mode lightning surge	Rise time 1.2μs, Fall time 50μs Interval 20s, 10 times Judge : no over-current, no miss operating	±5.0	-	-	kV

● Recommendable value

Item	Symbol	Min.	Typ.	Max.	Unit
DC Bus Voltage	VDC	-	-	400	V
Operating Supply Voltage of Pre-Driver	Vcc	13.5	15.0	16.5	V
Screw torque (M5)	-	2.5	-	3.0	Nm

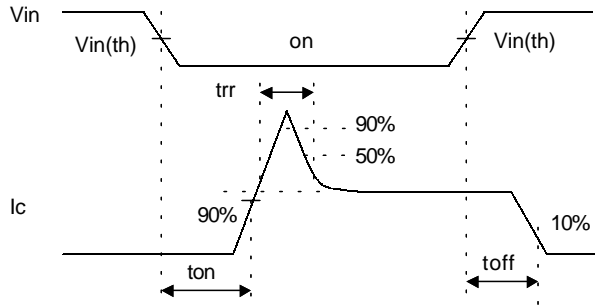
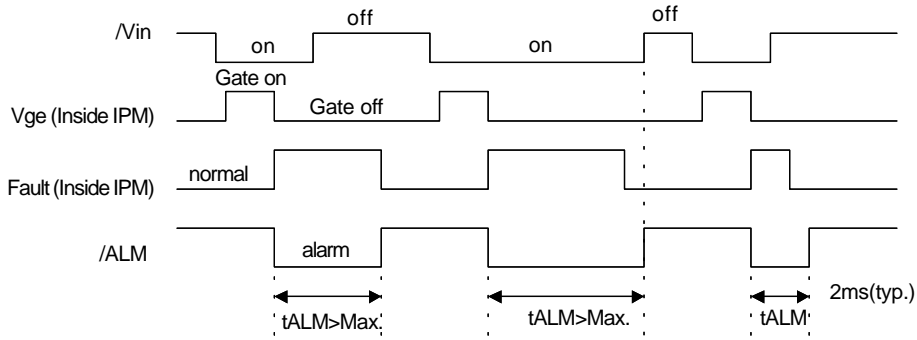

Figure 1. Switching Time Waveform Definitions



Fault : Over-current, Over-heat or Under-voltage

Figure 2. Input / Output Timing Diagram

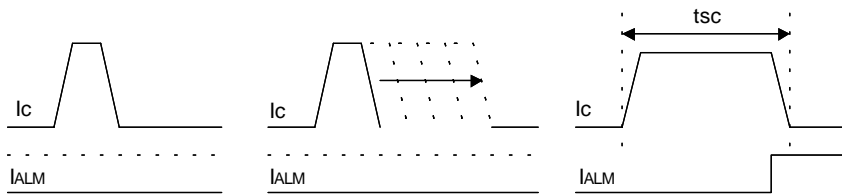

Figure 4 Definition of tsc

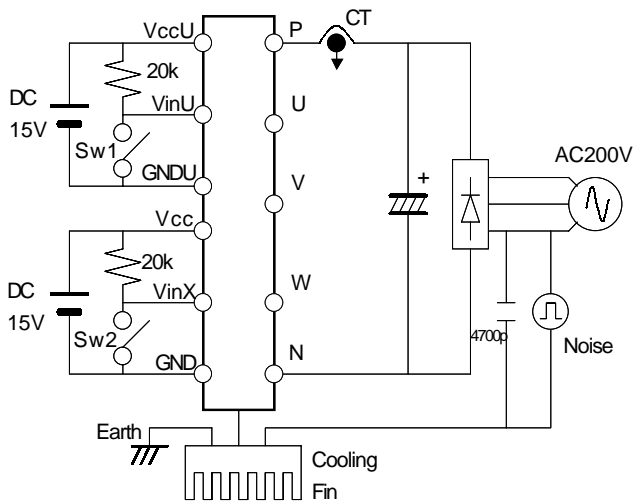

Figure 5. Noise Test Circuit

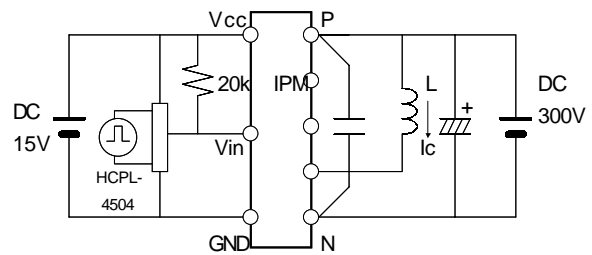

Figure 6. Switching Characteristics Test Circuit

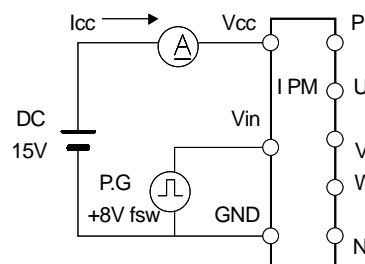
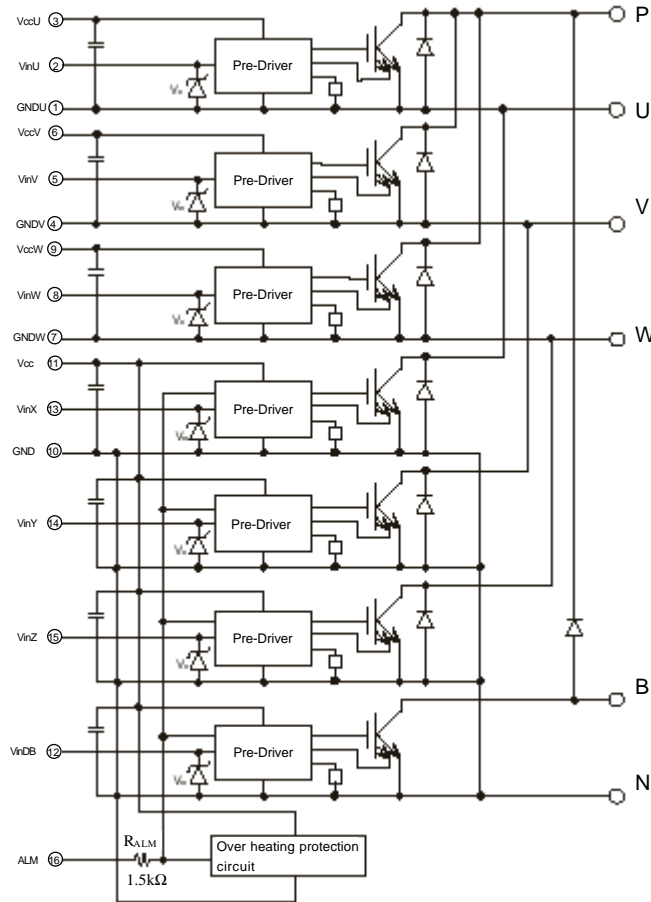

Figure 7. Icc Test Circuit

Block diagram



- Pre-driver include following functions
- ① Amplifier for drive
 - ② Short circuit protection
 - ③ Under voltage lockout circuit
 - ④ Over current protection
 - ⑤ IGBT chip over heating protection

Outline drawings, mm

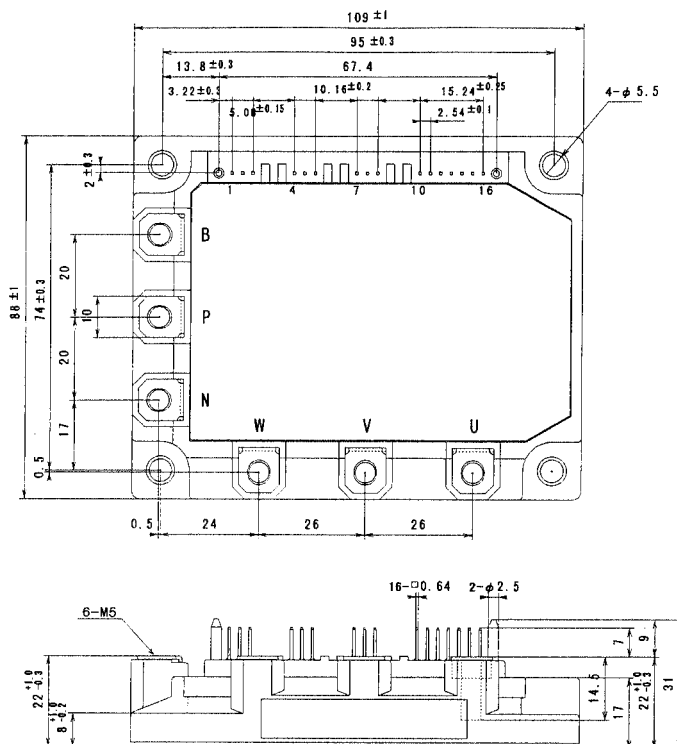

Mass : 450g

Characteristics

Control circuit characteristics (Representative)

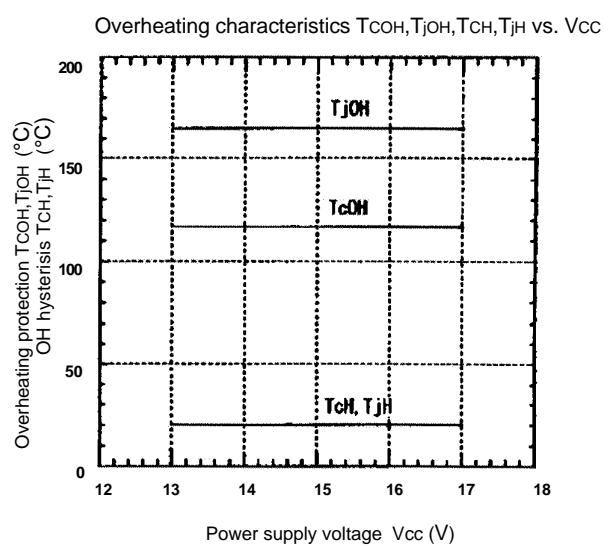
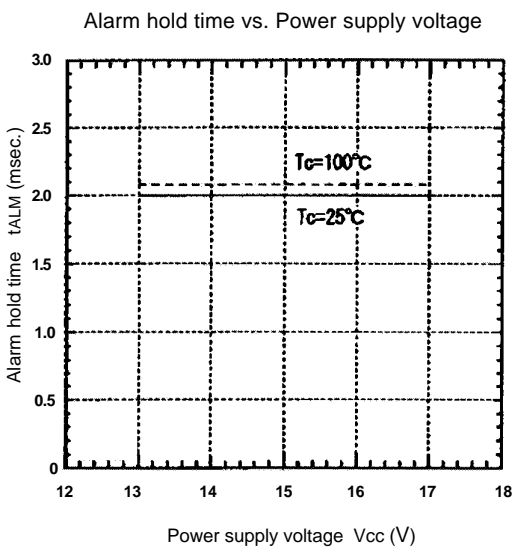
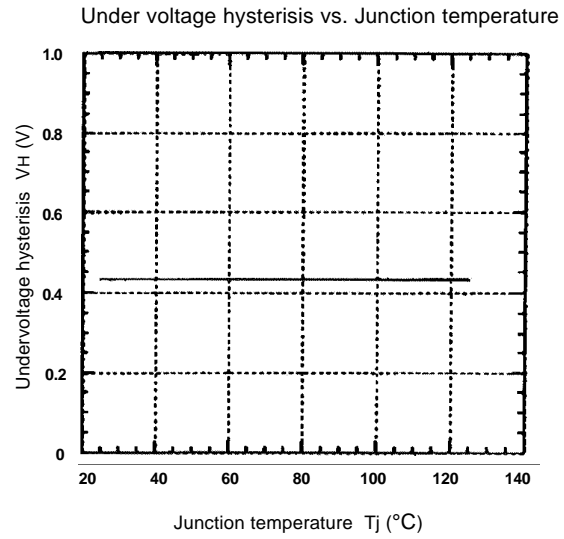
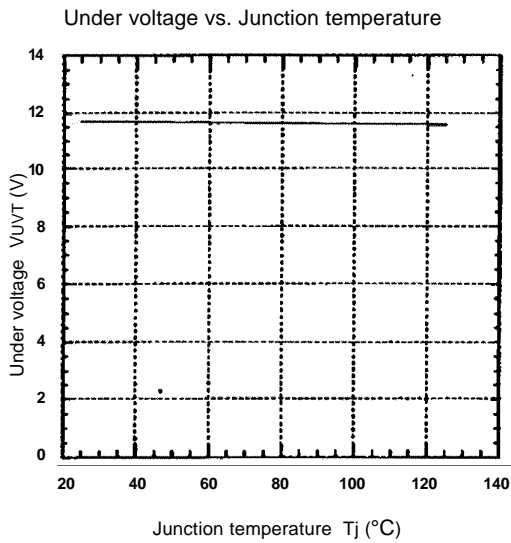
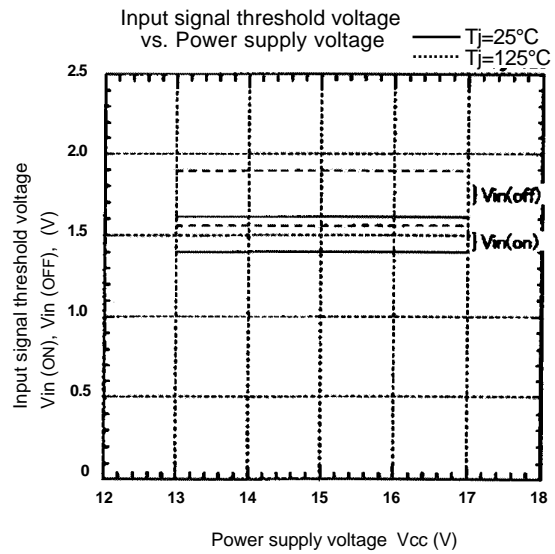
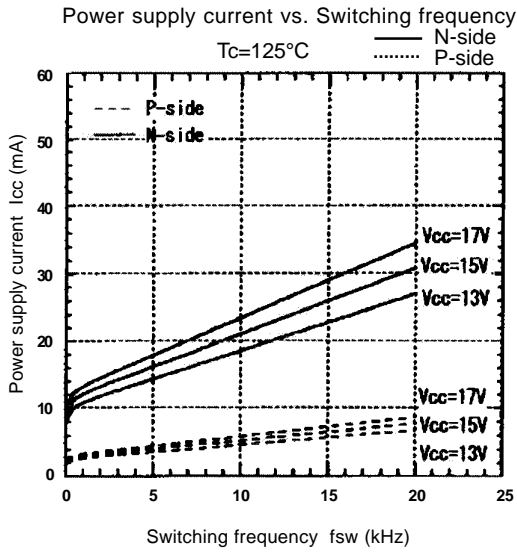

● Main circuit characteristics (Representative)

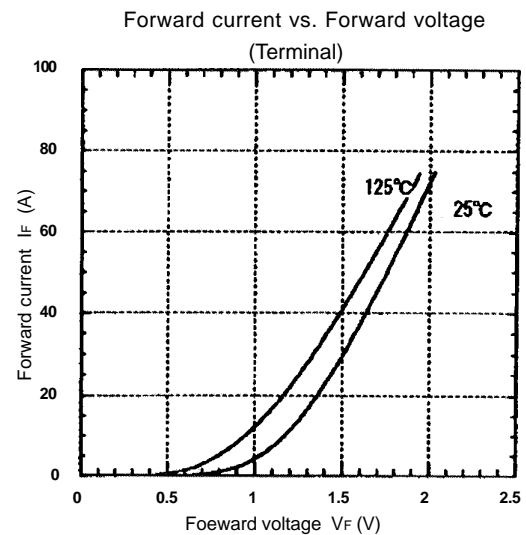
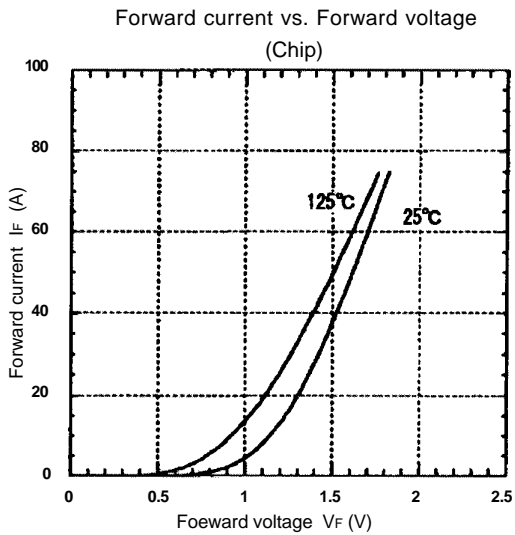
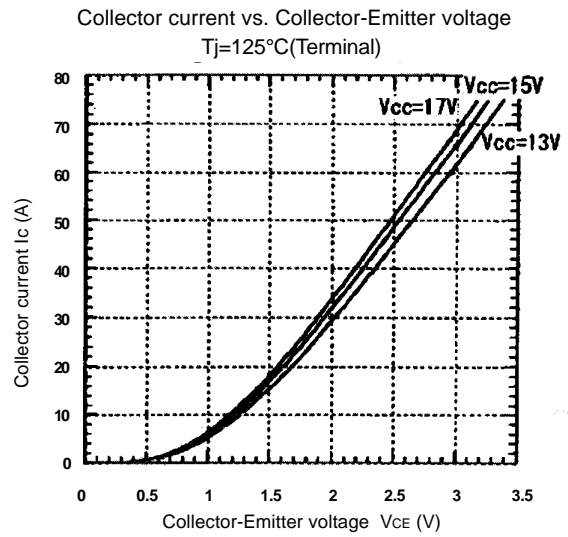
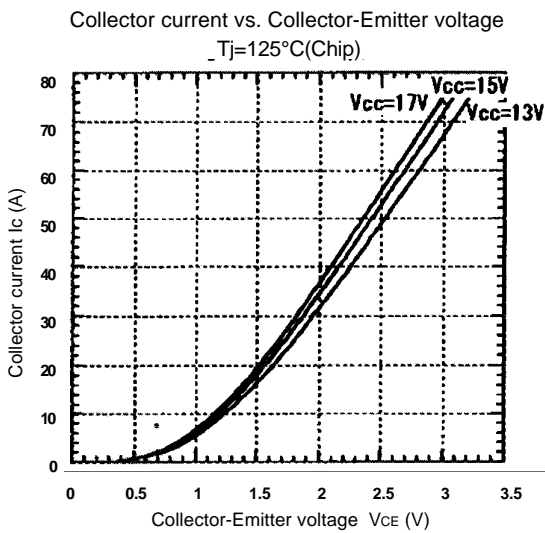
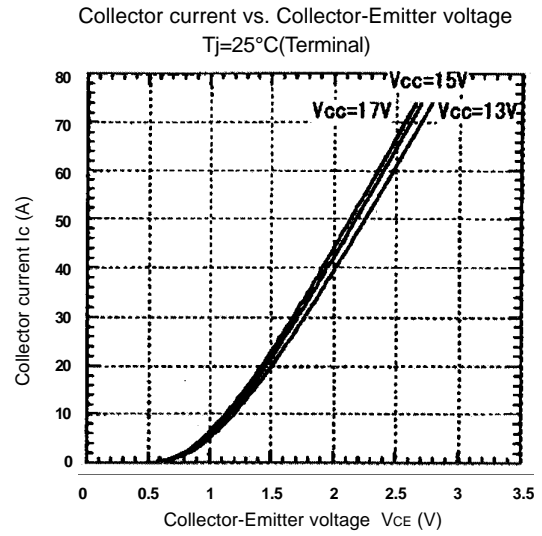
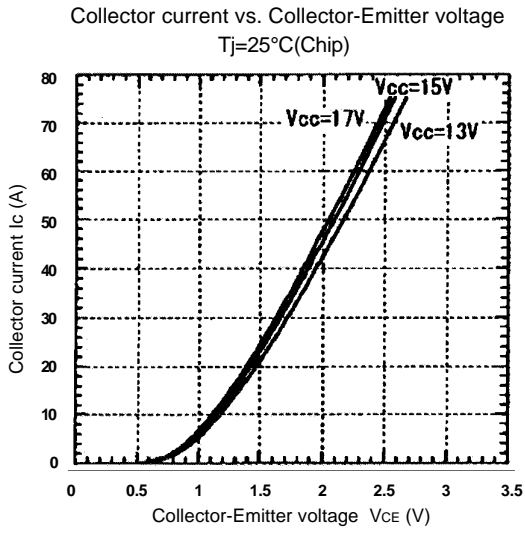

Switching Loss vs. Collector current
 $E_{dc}=300V, V_{cc}=15V, T_j=25^\circ C$

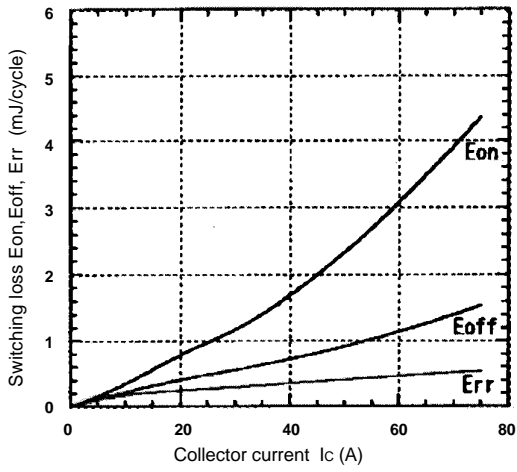

Switching Loss vs. Collector current
 $E_{dc}=300V, V_{cc}=15V, T_j=125^\circ C$

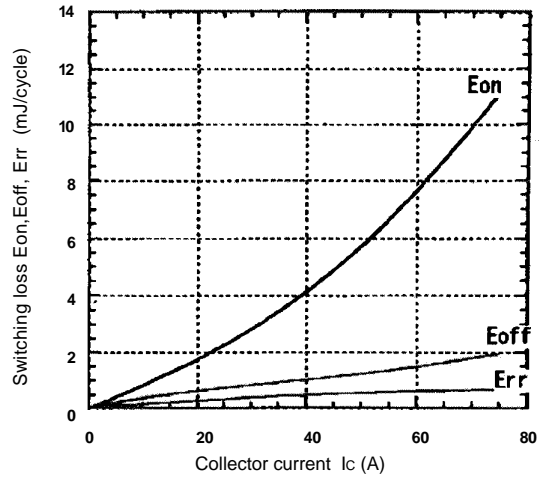

Reverse biased safe operating area
 $V_{cc}=15V, T_j \le 125^\circ C$

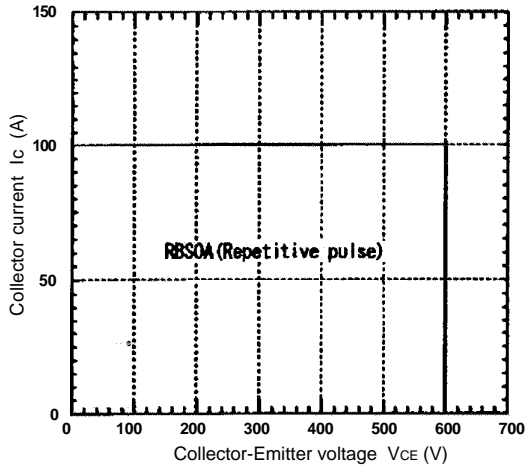

Transient thermal resistance

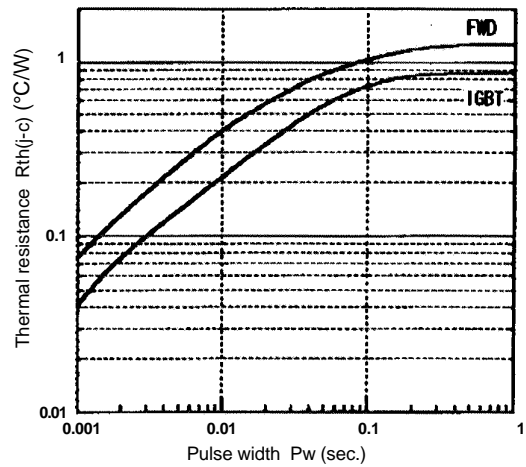

Power derating for IGBT (per device)

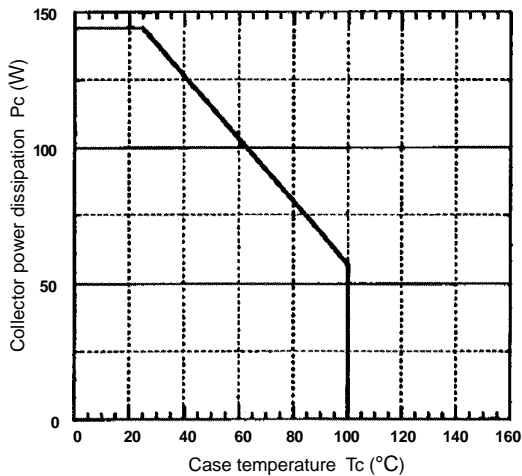

Power derating for FWD (per device)

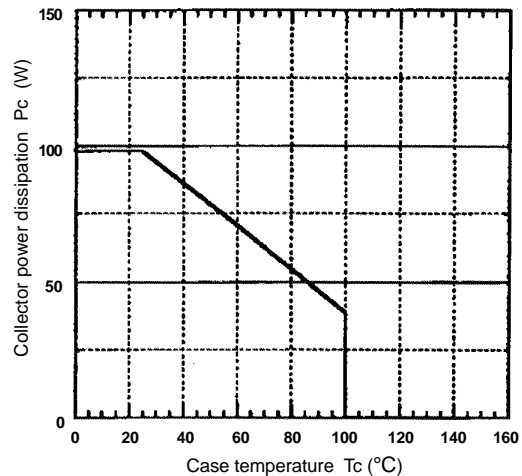

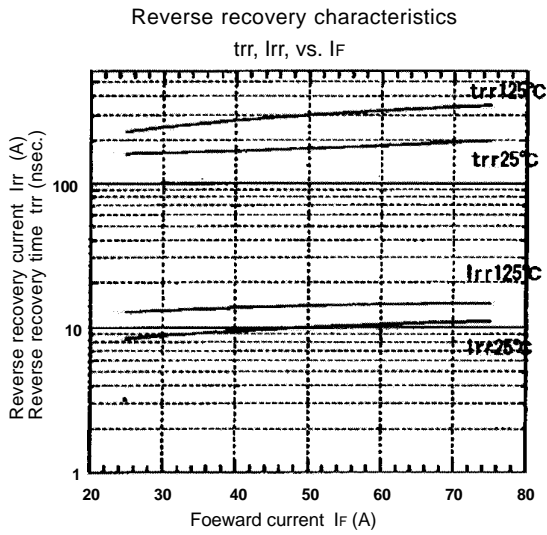
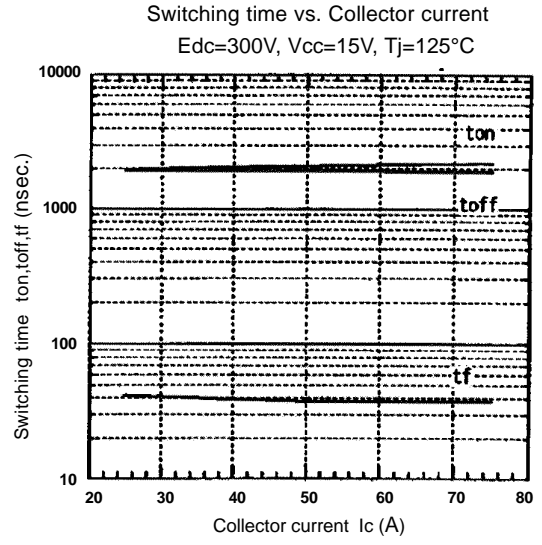
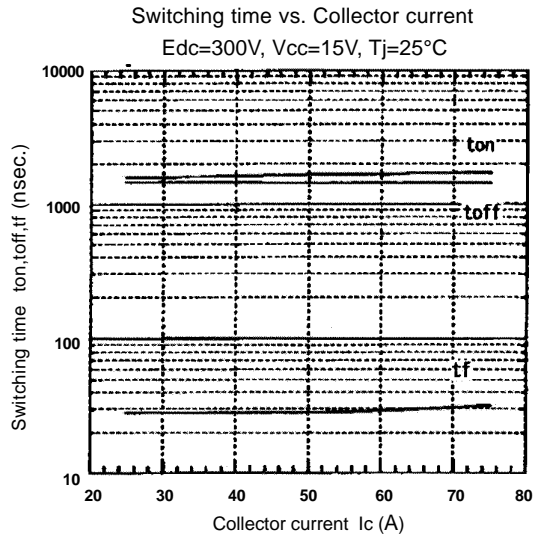

● Dynamic brake characteristics (Representative)

Collector current vs. Collector-Emitter voltage
T_j=25°C (Terminal)

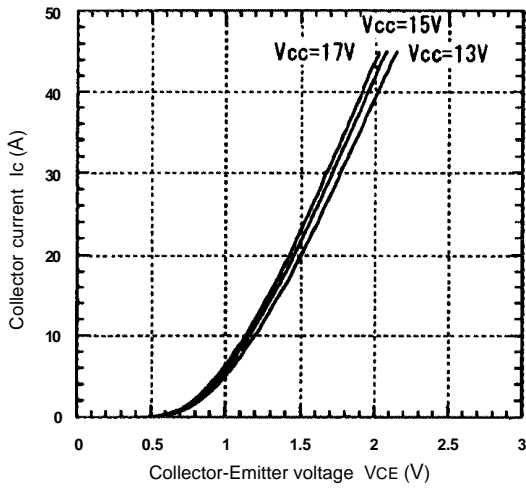

Collector current vs. Collector-Emitter voltage
T_j=125°C (Terminal)

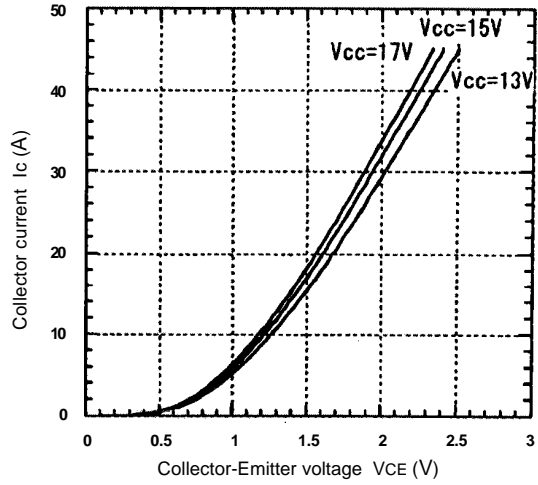

Transient thermal resistance

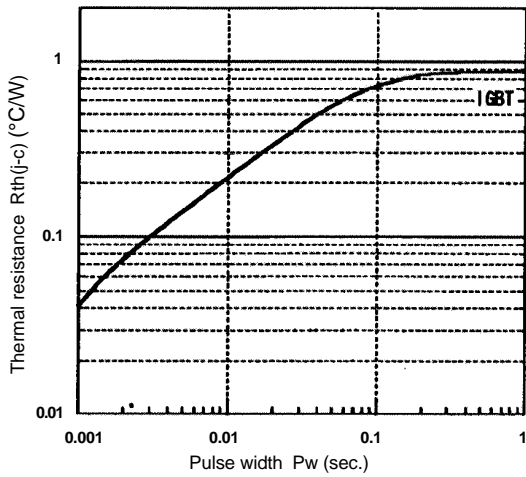

Reverse biased safe operating area
V_{cc}=15V, T_j ≤ 125°C

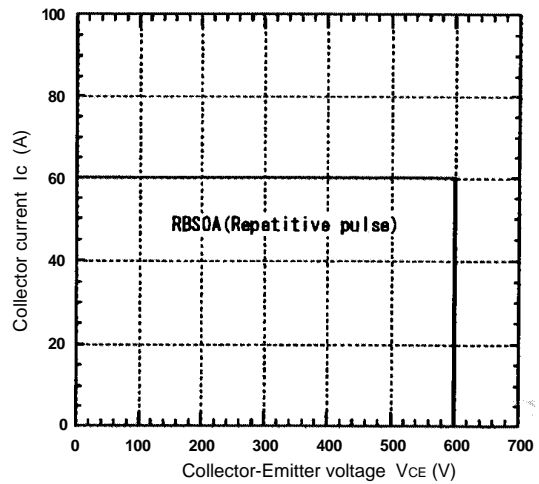

Power derating for IGBT (per device)

