

## Silicon Epitaxial Planar Zener-Diodes

### Features

- Very sharp reverse characteristic
- Low reverse current level
- Very high stability
- Low noise
- TZMC -  $V_Z$ -tolerance  $\pm 5\%$
- TZMB -  $V_Z$ -tolerance  $\pm 2\%$
- Available with tighter tolerances

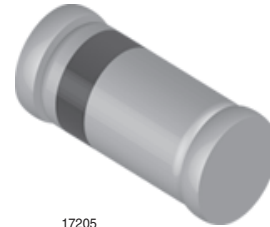

### Applications

Voltage stabilization

### Mechanical Data

**Case:** MiniMELF Glass Case (SOD-80)

**Weight:** approx. 31 mg

### Packaging codes/ options:

GS08/ 2.5 k per 7" reel (8 mm tape), 12.5 k/box

GS18/ 10 k per 13" reel (8 mm tape), 10 k/box

### Absolute Maximum Ratings

$T_{amb} = 25\text{ }^\circ\text{C}$ , unless otherwise specified

Parameter	Test condition	Symbol	Value	Unit
Power dissipation	$R_{thJA} \leq 300\text{ K/W}$	$P_{tot}$	500	mW
Z-current		$I_Z$	$P_{tot}/V_Z$	mA
Junction temperature		$T_j$	175	$^\circ\text{C}$
Storage temperature range		$T_{stg}$	- 65 to + 175	$^\circ\text{C}$

### Thermal Characteristics

$T_{amb} = 25\text{ }^\circ\text{C}$ , unless otherwise specified

Parameter	Test condition	Symbol	Value	Unit
Junction ambient	on PC board 50 mm x 50 mm x 1.6 mm	$R_{thJA}$	500	K/W

### Electrical Characteristics

$T_{amb} = 25\text{ }^\circ\text{C}$ , unless otherwise specified

Parameter	Test condition	Symbol	Min	Typ.	Max	Unit
Forward voltage	$I_F = 200\text{ mA}$	$V_F$			1.5	V



## Electrical Characteristics

Partnumber	Zener Voltage Range		Dynamic Resistance		Test Current		Reverse Leakage Current			Temperature Coefficient of Zener Voltage	
	$V_Z @ I_{ZT}$		$r_{zT} @ I_{ZT}$	$r_{zK} @ I_{ZK}$	$I_{ZT}$	$I_{ZK}$	$I_R$	$I_R^{1)}$	@ $V_R$	TK <sub>VZ</sub>	
	V	V	$\Omega$	$\Omega$	mA	mA	$\mu A$	$\mu A$	V	%/K	%/K
	min	max	typ	typ						min	max
TZMC2V4	2.28	2.56	< 85	< 600	5	1	< 50	< 100	1	-0.09	-0.06
TZMC2V7	2.5	2.9	< 85	< 600	5	1	< 10	< 50	1	-0.09	-0.06
TZMC3V0	2.8	3.2	< 90	< 600	5	1	< 4	< 40	1	-0.08	-0.05
TZMC3V3	3.1	3.5	< 90	< 600	5	1	< 2	< 40	1	-0.08	-0.05
TZMC3V6	3.4	3.8	< 90	< 600	5	1	< 2	< 40	1	-0.08	-0.05
TZMC3V9	3.7	4.1	< 90	< 600	5	1	< 2	< 40	1	-0.08	-0.05
TZMC4V3	4	4.6	< 90	< 600	5	1	< 1	< 20	1	-0.06	-0.03
TZMC4V7	4.4	5	< 80	< 600	5	1	< 0.5	< 10	1	-0.05	0.02
TZMC5V1	4.8	5.4	< 60	< 550	5	1	< 0.1	< 2	1	-0.02	0.02
TZMC5V6	5.2	6	< 40	< 450	5	1	< 0.1	< 2	1	-0.05	0.05
TZMC6V2	5.8	6.6	< 10	< 200	5	1	< 0.1	< 2	2	0.03	0.06
TZMC6V8	6.4	7.2	< 8	< 150	5	1	< 0.1	< 2	3	0.03	0.07
TZMC7V5	7	7.9	< 7	< 50	5	1	< 0.1	< 2	5	0.03	0.07
TZMC8V2	7.7	8.7	< 7	< 50	5	1	< 0.1	< 2	6.2	0.03	0.08
TZMC9V1	8.5	9.6	< 10	< 50	5	1	< 0.1	< 2	6.8	0.03	0.09
TZMC10	9.4	10.6	< 15	< 70	5	1	< 0.1	< 2	7.5	0.03	0.1
TZMC11	10.4	11.6	< 20	< 70	5	1	< 0.1	< 2	8.2	0.03	0.11
TZMC12	11.4	12.7	< 20	< 90	5	1	< 0.1	< 2	9.1	0.03	0.11
TZMC13	12.4	14.1	< 26	< 110	5	1	< 0.1	< 2	10	0.03	0.11
TZMC15	13.8	15.6	< 30	< 110	5	1	< 0.1	< 2	11	0.03	0.11
TZMC16	15.3	17.1	< 40	< 170	5	1	< 0.1	< 2	12	0.03	0.11
TZMC18	16.8	19.1	< 50	< 170	5	1	< 0.1	< 2	13	0.03	0.11
TZMC20	18.8	21.2	< 55	< 220	5	1	< 0.1	< 2	15	0.03	0.11
TZMC22	20.8	23.3	< 55	< 220	5	1	< 0.1	< 2	16	0.04	0.12
TZMC24	22.8	25.6	< 80	< 220	5	1	< 0.1	< 2	18	0.04	0.12
TZMC27	25.1	28.9	< 80	< 220	5	1	< 0.1	< 2	20	0.04	0.12
TZMC30	28	32	< 80	< 220	5	1	< 0.1	< 2	22	0.04	0.12
TZMC33	31	35	< 80	< 220	5	1	< 0.1	< 2	24	0.04	0.12
TZMC36	34	38	< 80	< 220	5	1	< 0.1	< 2	27	0.04	0.12
TZMC39	37	41	< 90	< 500	2.5	0.5	< 0.1	< 5	30	0.04	0.12
TZMC43	40	46	< 90	< 600	2.5	0.5	< 0.1	< 5	33	0.04	0.12
TZMC47	44	50	< 110	< 700	2.5	0.5	< 0.1	< 5	36	0.04	0.12
TZMC51	48	54	< 125	< 700	2.5	0.5	< 0.1	< 10	39	0.04	0.12
TZMC56	52	60	< 135	< 1000	2.5	0.5	< 0.1	< 10	43	0.04	0.12
TZMC62	58	66	< 150	< 1000	2.5	0.5	< 0.1	< 10	47	0.04	0.12
TZMC68	64	72	< 200	< 1000	2.5	0.5	< 0.1	< 10	51	0.04	0.12
TZMC75	70	79	< 250	< 1500	2.5	0.5	< 0.1	< 10	56	0.04	0.12

<sup>1)</sup> at  $T_j = 150^\circ C$



## Electrical Characteristics

Partnumber	Zener Voltage Range		Dynamic Resistance		Test Current		Reverse Leakage Current			Temperature Coefficient of Zener Voltage	
	$V_Z @ I_{ZT}$		$r_{zjT} @ I_{ZT}$	$r_{zjk} @ I_{ZK}$	$I_{ZT}$	$I_{ZK}$	$I_R$	$I_R^{1)}$	@ $V_R$	TK <sub>VZ</sub>	
	V	V	$\Omega$	$\Omega$	mA	mA	$\mu A$	$\mu A$	V	%/K	%/K
	min	max	typ	typ						min	max
TZMB2V4	2.35	2.45	< 85	< 600	5	1	< 50	< 100	1	-0.09	-0.06
TZMB2V7	2.64	2.76	< 85	< 600	5	1	< 10	< 50	1	-0.09	-0.06
TZMB3V0	2.94	3.06	< 90	< 600	5	1	< 4	< 40	1	-0.08	-0.05
TZMB3V3	3.24	3.36	< 90	< 600	5	1	< 2	< 40	1	-0.08	-0.05
TZMB3V6	3.52	3.68	< 90	< 600	5	1	< 2	< 40	1	-0.08	-0.05
TZMB3V9	3.82	3.98	< 90	< 600	5	1	< 2	< 40	1	-0.08	-0.05
TZMB4V3	4.22	4.38	< 90	< 600	5	1	< 1	< 20	1	-0.06	-0.03
TZMB4V7	4.6	4.8	< 80	< 600	5	1	< 0.5	< 10	1	-0.05	0.02
TZMB5V1	5	5.2	< 60	< 550	5	1	< 0.1	< 2	1	-0.02	0.02
TZMB5V6	5.48	5.72	< 40	< 450	5	1	< 0.1	< 2	1	-0.05	0.05
TZMB6V2	6.08	6.32	< 10	< 200	5	1	< 0.1	< 2	2	0.03	0.06
TZMB6V8	6.66	6.94	< 8	< 150	5	1	< 0.1	< 2	3	0.03	0.07
TZMB7V5	7.35	7.65	< 7	< 50	5	1	< 0.1	< 2	5	0.03	0.07
TZMB8V2	8.04	8.36	< 7	< 50	5	1	< 0.1	< 2	6.2	0.03	0.08
TZMB9V1	8.92	9.28	< 10	< 50	5	1	< 0.1	< 2	6.8	0.03	0.09
TZMB10	9.8	10.2	< 15	< 70	5	1	< 0.1	< 2	7.5	0.03	0.1
TZMB11	10.78	11.22	< 20	< 70	5	1	< 0.1	< 2	8.2	0.03	0.11
TZMB12	11.76	12.24	< 20	< 90	5	1	< 0.1	< 2	9.1	0.03	0.11
TZMB13	12.74	13.26	< 26	< 110	5	1	< 0.1	< 2	10	0.03	0.11
TZMB15	14.7	15.3	< 30	< 110	5	1	< 0.1	< 2	11	0.03	0.11
TZMB16	15.7	16.3	< 40	< 170	5	1	< 0.1	< 2	12	0.03	0.11
TZMB18	17.64	18.36	< 50	< 170	5	1	< 0.1	< 2	13	0.03	0.11
TZMB20	19.6	20.4	< 55	< 220	5	1	< 0.1	< 2	15	0.03	0.11
TZMB22	21.55	22.45	< 55	< 220	5	1	< 0.1	< 2	16	0.04	0.12
TZMB24	23.5	24.5	< 80	< 220	5	1	< 0.1	< 2	18	0.04	0.12
TZMB27	26.4	27.6	< 80	< 220	5	1	< 0.1	< 2	20	0.04	0.12
TZMB30	29.4	30.6	< 80	< 220	5	1	< 0.1	< 2	22	0.04	0.12
TZMB33	32.4	33.6	< 80	< 220	5	1	< 0.1	< 2	24	0.04	0.12
TZMB36	35.3	36.7	< 80	< 220	5	1	< 0.1	< 2	27	0.04	0.12
TZMB39	38.2	39.8	< 90	< 500	2.5	1	< 0.1	< 5	30	0.04	0.12
TZMB43	42.1	43.9	< 90	< 600	2.5	0.5	< 0.1	< 5	33	0.04	0.12
TZMB47	46.1	47.9	< 110	< 700	2.5	0.5	< 0.1	< 5	36	0.04	0.12
TZMB51	50	52	< 125	< 700	2.5	0.5	< 0.1	< 10	39	0.04	0.12
TZMB56	54.9	57.1	< 135	< 1000	2.5	0.5	< 0.1	< 10	43	0.04	0.12
TZMB62	60.8	63.2	< 150	< 1000	2.5	0.5	< 0.1	< 10	47	0.04	0.12
TZMB68	66.6	69.4	< 200	< 1000	2.5	0.5	< 0.1	< 10	51	0.04	0.12
TZMB75	73.5	76.5	< 250	< 1500	2.5	0.5	< 0.1	< 10	56	0.04	0.12

<sup>1)</sup> at  $T_j = 150^\circ C$

NOTE: Additional measurement of voltage group TZMB9V1 to TZMB75,  $I_R$  at 95 %  $V_{Zmin} = < 35$  nA at  $T_j = 25^\circ C$

## Typical Characteristics ( $T_{amb} = 25\text{ }^{\circ}\text{C}$ unless otherwise specified)

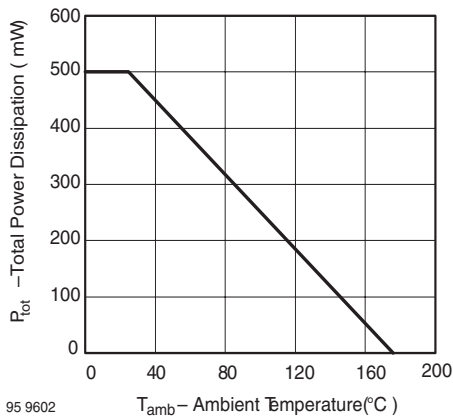

Fig. 1 Total Power Dissipation vs. Ambient Temperature

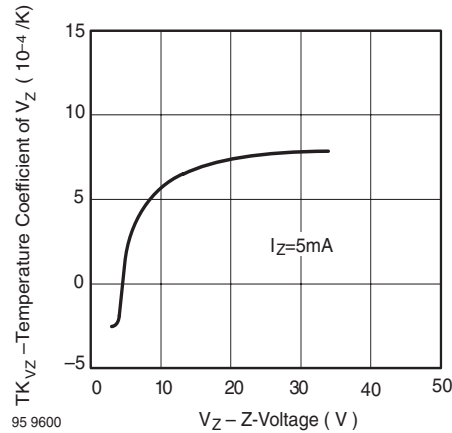

Fig. 4 Temperature Coefficient of  $V_Z$  vs. Z-Voltage

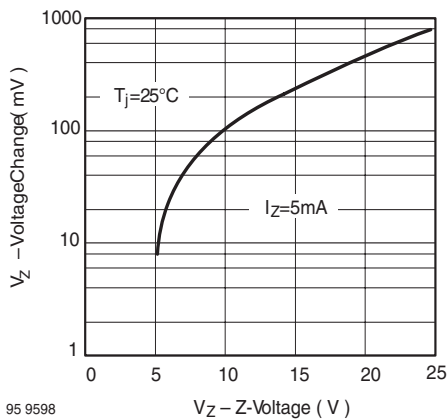

Fig. 2 Typical Change of Working Voltage under Operating Conditions at  $T_{amb}=25\text{ }^{\circ}\text{C}$

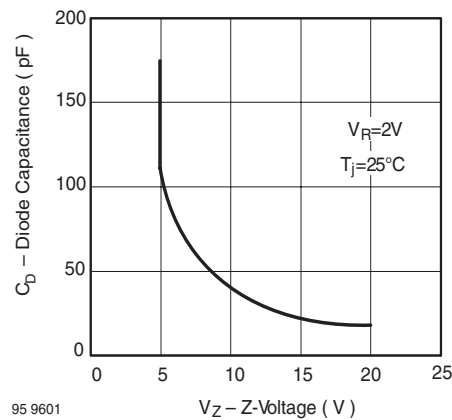

Fig. 5 Diode Capacitance vs. Z-Voltage

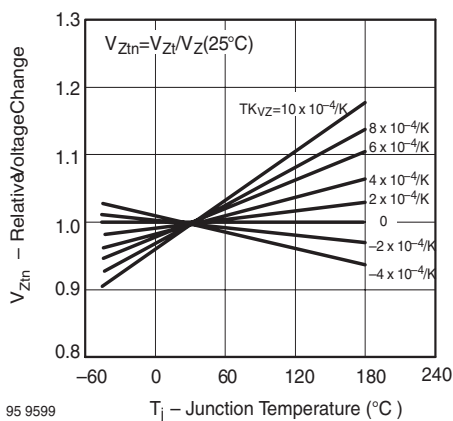

Fig. 3 Typical Change of Working Voltage vs. Junction Temperature

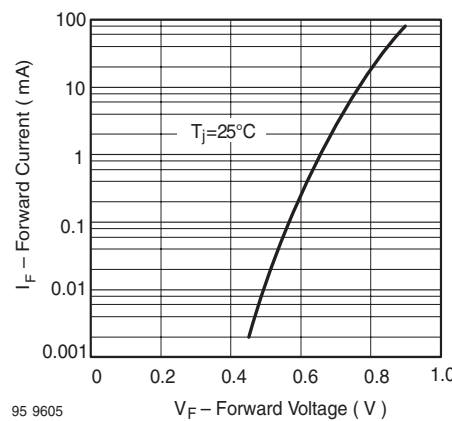

Fig. 6 Forward Current vs. Forward Voltage

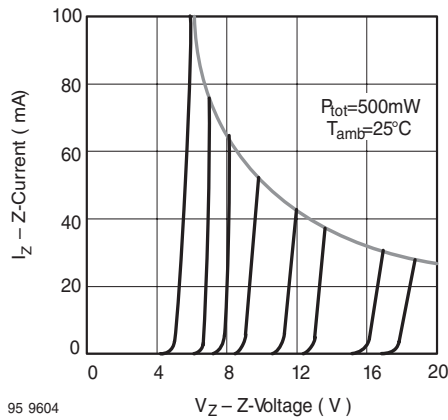

Fig. 7 Z-Current vs. Z-Voltage

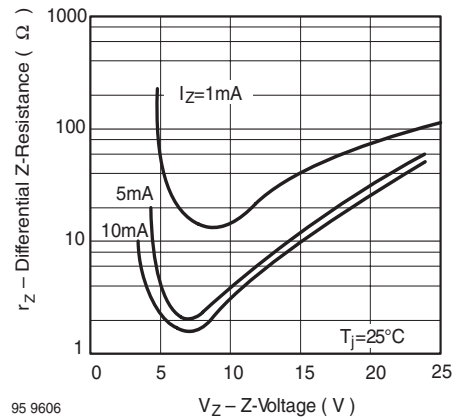

Fig. 9 Differential Z-Resistance vs. Z-Voltage

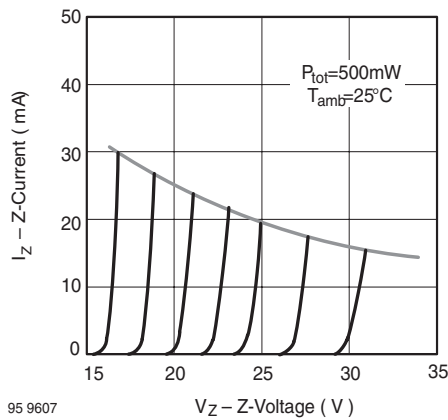

Fig. 8 Z-Current vs. Z-Voltage

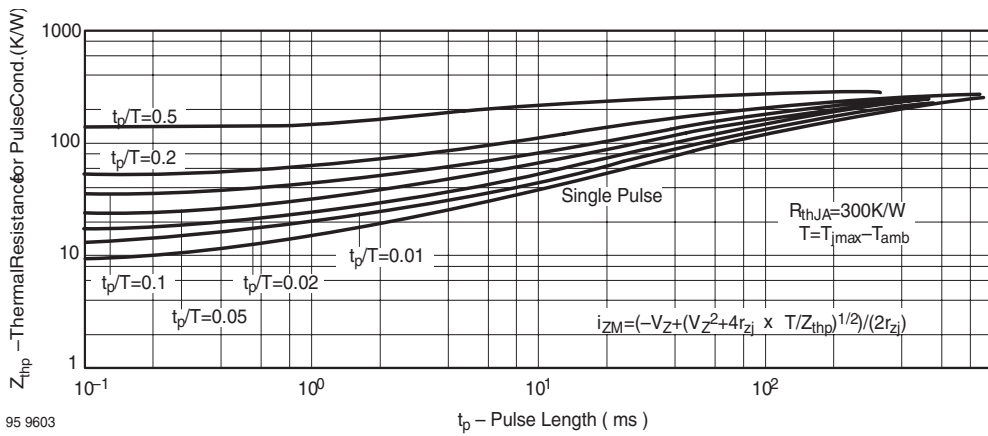
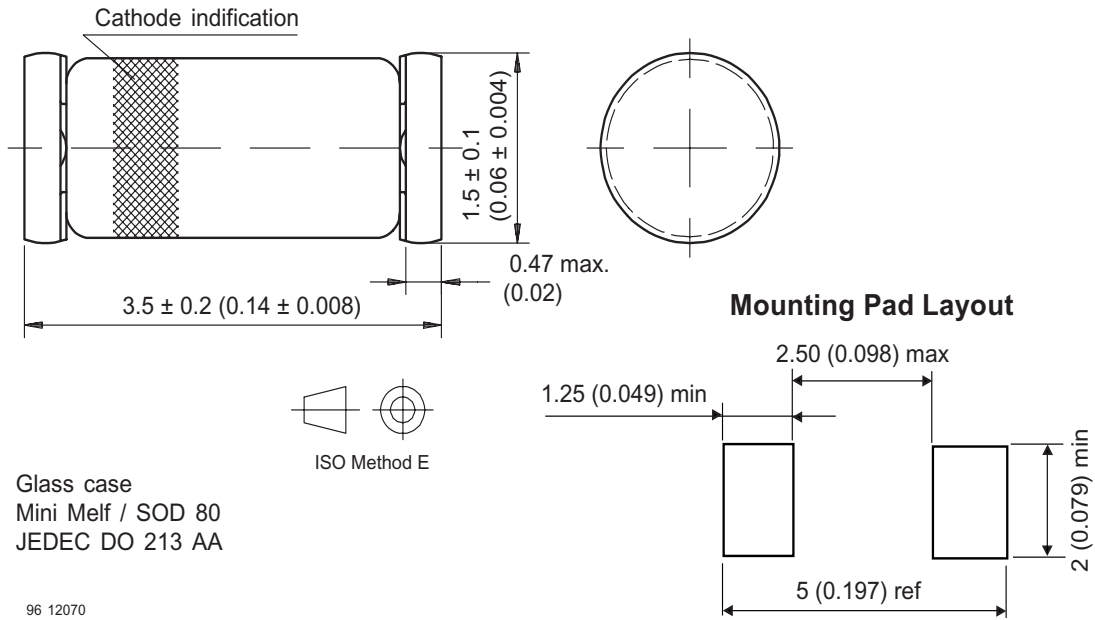

Fig. 10 Thermal Response

## Package Dimensions in mm (Inches)





## Ozone Depleting Substances Policy Statement

It is the policy of **Vishay Semiconductor GmbH** to

1. Meet all present and future national and international statutory requirements.
2. Regularly and continuously improve the performance of our products, processes, distribution and operating systems with respect to their impact on the health and safety of our employees and the public, as well as their impact on the environment.

It is particular concern to control or eliminate releases of those substances into the atmosphere which are known as ozone depleting substances (ODSs).

The Montreal Protocol (1987) and its London Amendments (1990) intend to severely restrict the use of ODSs and forbid their use within the next ten years. Various national and international initiatives are pressing for an earlier ban on these substances.

**Vishay Semiconductor GmbH** has been able to use its policy of continuous improvements to eliminate the use of ODSs listed in the following documents.

1. Annex A, B and list of transitional substances of the Montreal Protocol and the London Amendments respectively
2. Class I and II ozone depleting substances in the Clean Air Act Amendments of 1990 by the Environmental Protection Agency (EPA) in the USA
3. Council Decision 88/540/EEC and 91/690/EEC Annex A, B and C (transitional substances) respectively.

**Vishay Semiconductor GmbH** can certify that our semiconductors are not manufactured with ozone depleting substances and do not contain such substances.

**We reserve the right to make changes to improve technical design  
and may do so without further notice.**

Parameters can vary in different applications. All operating parameters must be validated for each customer application by the customer. Should the buyer use Vishay Semiconductors products for any unintended or unauthorized application, the buyer shall indemnify Vishay Semiconductors against all claims, costs, damages, and expenses, arising out of, directly or indirectly, any claim of personal damage, injury or death associated with such unintended or unauthorized use.

Vishay Semiconductor GmbH, P.O.B. 3535, D-74025 Heilbronn, Germany  
Telephone: 49 (0)7131 67 2831, Fax number: 49 (0)7131 67 2423