

SIPMOS[®] Power Transistor

- N channel
- Enhancement mode

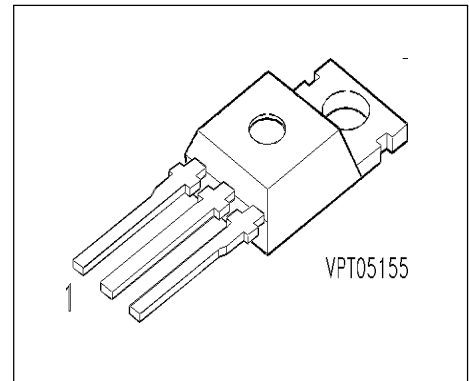

| Pin 1 | Pin 2 | Pin 3 |
|-------|-------|-------|
| G | D | S |

| Type | V_{DS} | I_D | $R_{DS(on)}$ | Package | Ordering Code |
|---------|----------|-------|--------------|-----------|-----------------|
| BUZ 80A | 800 V | 3 A | 3 Ω | TO-220 AB | C67078-A1309-A3 |

Maximum Ratings

| Parameter | Symbol | Values | Unit |
|---|-------------|------------------|------------------|
| Drain source voltage | V_{DS} | 800 | V |
| Drain-gate voltage $R_{GS} = 20 \text{ k}\Omega$ | V_{DGR} | 800 | |
| Continuous drain current $T_C = 50 \text{ }^\circ\text{C}$ | I_D | 3 | A |
| Pulsed drain current $T_C = 25 \text{ }^\circ\text{C}$ | I_{Dpuls} | 12 | |
| Gate source voltage | V_{GS} | ± 20 | V |
| Power dissipation $T_C = 25 \text{ }^\circ\text{C}$ | P_{tot} | 75 | W |
| Operating temperature | T_j | -55+ 150 | $^\circ\text{C}$ |
| Storage temperature | T_{stg} | -55+ 150 | |
| Thermal resistance, chip case | R_{thJC} | ≤ 1.67 | K/W |
| Thermal resistance, chip to ambient | R_{thJA} | 75 | |
| DIN humidity category, DIN 40 040 | | E | |
| IEC climatic category, DIN IEC 68-1 | | 55 / 150 / 56 | |

Electrical Characteristics, at $T_j = 25^\circ\text{C}$, unless otherwise specified

| Parameter | Symbol | Values | | | Unit |
|--|---------------|--------|-----------|-------------|---------------|
| | | min. | typ. | max. | |
| Static Characteristics | | | | | |
| Drain- source breakdown voltage $V_{GS} = 0\text{ V}$, $I_D = 0.25\text{ mA}$, $T_j = 25\text{ }^\circ\text{C}$ | $V_{(BR)DSS}$ | 800 | - | - | V |
| Gate threshold voltage $V_{GS} = V_{DS}$, $I_D = 1\text{ mA}$ | $V_{GS(th)}$ | 2.1 | 3 | 4 | |
| Zero gate voltage drain current $V_{DS} = 800\text{ V}$, $V_{GS} = 0\text{ V}$, $T_j = 25\text{ }^\circ\text{C}$ $V_{DS} = 800\text{ V}$, $V_{GS} = 0\text{ V}$, $T_j = 125\text{ }^\circ\text{C}$ | I_{DSS} | - | 20 100 | 250 1000 | μA |
| Gate-source leakage current $V_{GS} = 20\text{ V}$, $V_{DS} = 0\text{ V}$ | I_{GSS} | - | 10 | 100 | nA |
| Drain-Source on-resistance $V_{GS} = 10\text{ V}$, $I_D = 1.5\text{ A}$ | $R_{DS(on)}$ | - | 2.7 | 3 | Ω |

Electrical Characteristics, at $T_j = 25^\circ\text{C}$, unless otherwise specified

| Parameter | Symbol | Values | | | Unit |
|--|--------------|--------|------|------|------|
| | | min. | typ. | max. | |
| Dynamic Characteristics | | | | | |
| Transconductance $V_{DS} \geq 2 \cdot I_D \cdot R_{DS(on)max}$, $I_D = 1.5 \text{ A}$ | g_{fs} | 1 | 1.8 | - | S |
| Input capacitance $V_{GS} = 0 \text{ V}$, $V_{DS} = 25 \text{ V}$, $f = 1 \text{ MHz}$ | C_{iss} | - | 1600 | 2100 | pF |
| Output capacitance $V_{GS} = 0 \text{ V}$, $V_{DS} = 25 \text{ V}$, $f = 1 \text{ MHz}$ | C_{oss} | - | 90 | 150 | |
| Reverse transfer capacitance $V_{GS} = 0 \text{ V}$, $V_{DS} = 25 \text{ V}$, $f = 1 \text{ MHz}$ | C_{rss} | - | 30 | 55 | |
| Turn-on delay time $V_{DD} = 30 \text{ V}$, $V_{GS} = 10 \text{ V}$, $I_D = 3 \text{ A}$ $R_{GS} = 50 \Omega$ | $t_{d(on)}$ | - | 30 | 45 | ns |
| Rise time $V_{DD} = 30 \text{ V}$, $V_{GS} = 10 \text{ V}$, $I_D = 3 \text{ A}$ $R_{GS} = 50 \Omega$ | t_r | - | 40 | 60 | |
| Turn-off delay time $V_{DD} = 30 \text{ V}$, $V_{GS} = 10 \text{ V}$, $I_D = 3 \text{ A}$ $R_{GS} = 50 \Omega$ | $t_{d(off)}$ | - | 110 | 140 | |
| Fall time $V_{DD} = 30 \text{ V}$, $V_{GS} = 10 \text{ V}$, $I_D = 3 \text{ A}$ $R_{GS} = 50 \Omega$ | t_f | - | 60 | 80 | |

Electrical Characteristics, at $T_j = 25^\circ\text{C}$, unless otherwise specified

| Parameter | Symbol | Values | | | Unit |
|--|----------|--------|------|------|---------------|
| | | min. | typ. | max. | |
| Reverse Diode | | | | | |
| Inverse diode continuous forward current $T_C = 25^\circ\text{C}$ | I_S | - | - | 3 | A |
| Inverse diode direct current, pulsed $T_C = 25^\circ\text{C}$ | I_{SM} | - | - | 12 | |
| Inverse diode forward voltage $V_{GS} = 0\text{ V}, I_F = 6\text{ A}$ | V_{SD} | - | 1.05 | 1.3 | V |
| Reverse recovery time $V_R = 100\text{ V}, I_F = I_S, di_F/dt = 100\text{ A}/\mu\text{s}$ | t_{rr} | - | 1.8 | - | μs |
| Reverse recovery charge $V_R = 100\text{ V}, I_F = I_S, di_F/dt = 100\text{ A}/\mu\text{s}$ | Q_{rr} | - | 12 | - | μC |

Power dissipation

$$P_{\text{tot}} = f(T_C)$$



Drain current

$$I_D = f(T_C)$$

parameter: $V_{GS} \geq 10 \text{ V}$

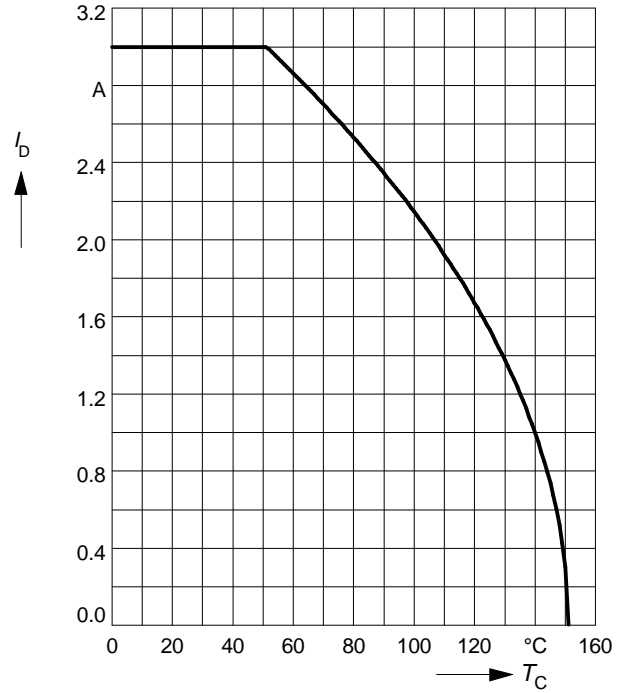

Safe operating area

$$I_D = f(V_{DS})$$

parameter: $D = 0.01$, $T_C = 25^\circ\text{C}$

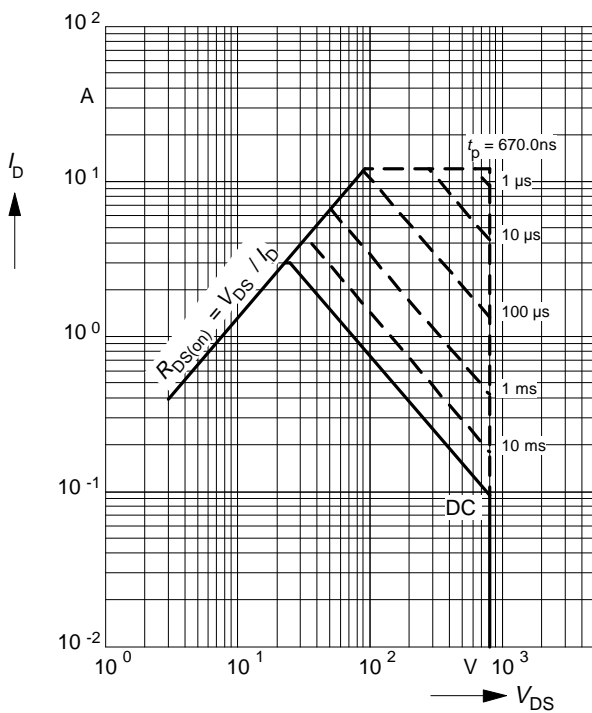

Transient thermal impedance

$$Z_{\text{thJC}} = f(t_p)$$

parameter: $D = t_p / T$

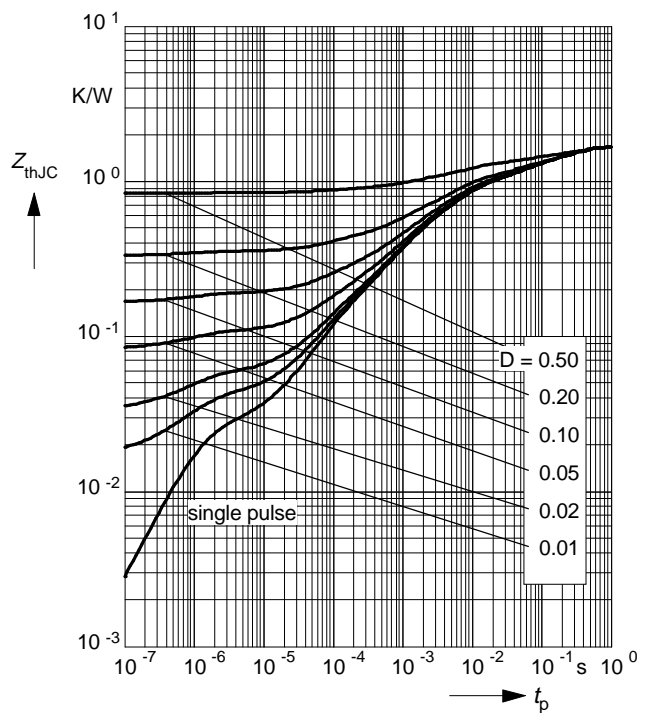

Typ. output characteristics

$$I_D = f(V_{DS})$$

parameter: $t_p = 80 \mu s$

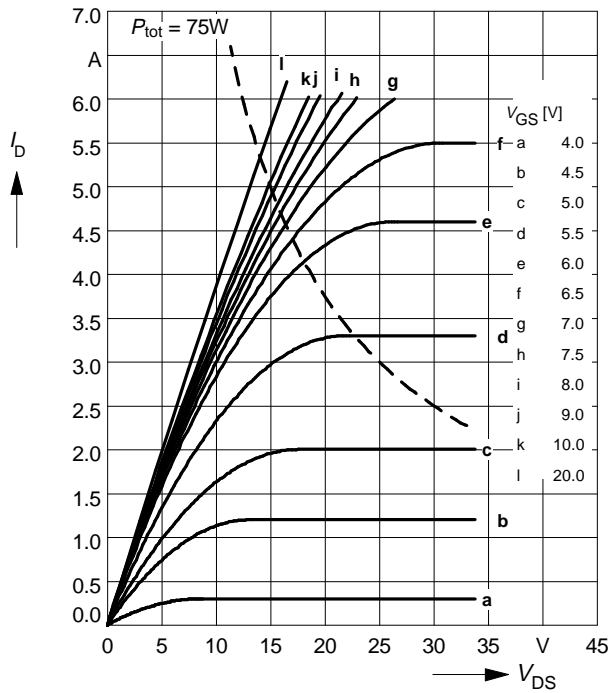

Typ. drain-source on-resistance

$$R_{DS(on)} = f(I_D)$$

parameter: V_{GS}

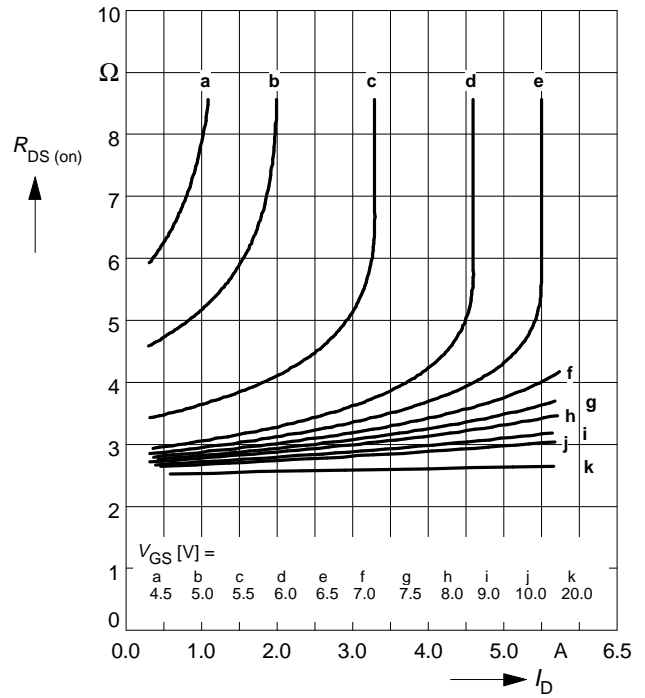

Typ. transfer characteristics $I_D = f(V_{GS})$

parameter: $t_p = 80 \mu s$

$$V_{DS} \geq 2 \times I_D \times R_{DS(on)max}$$

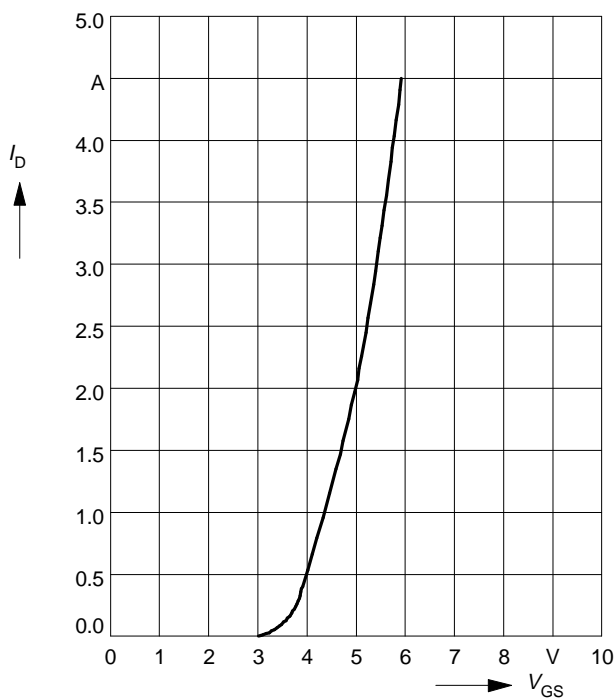

Typ. forward transconductance $g_{fs} = f(I_D)$

parameter: $t_p = 80 \mu s$,

$$V_{DS} \geq 2 \times I_D \times R_{DS(on)max}$$

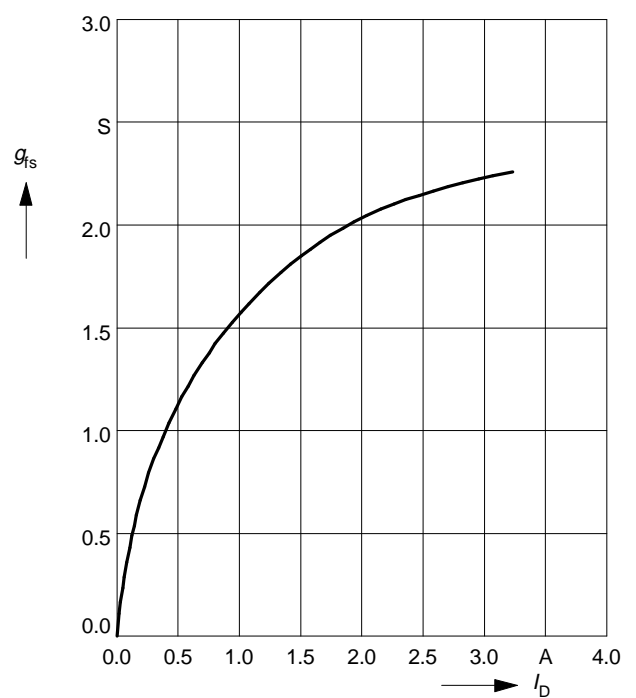

Drain-source on-resistance

$$R_{DS(on)} = f(T_j)$$

parameter: $I_D = 1.5 \text{ A}$, $V_{GS} = 10 \text{ V}$

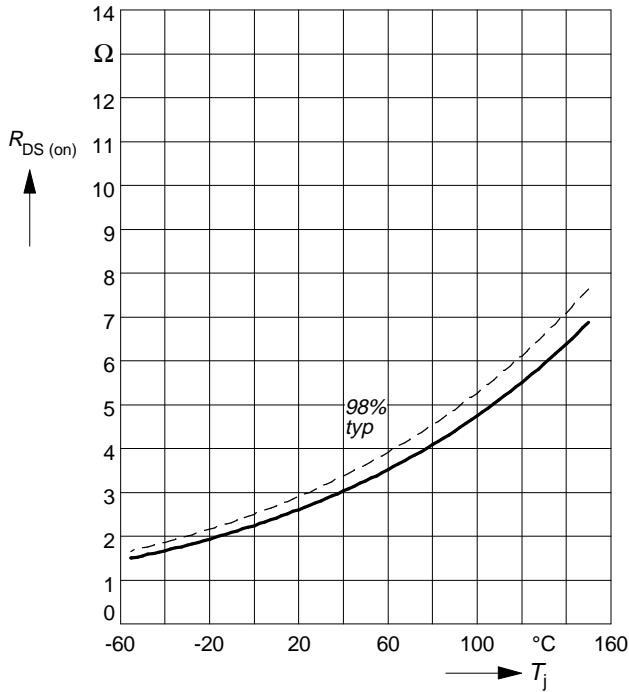

Gate threshold voltage

$$V_{GS(th)} = f(T_j)$$

parameter: $V_{GS} = V_{DS}$, $I_D = 1 \text{ mA}$

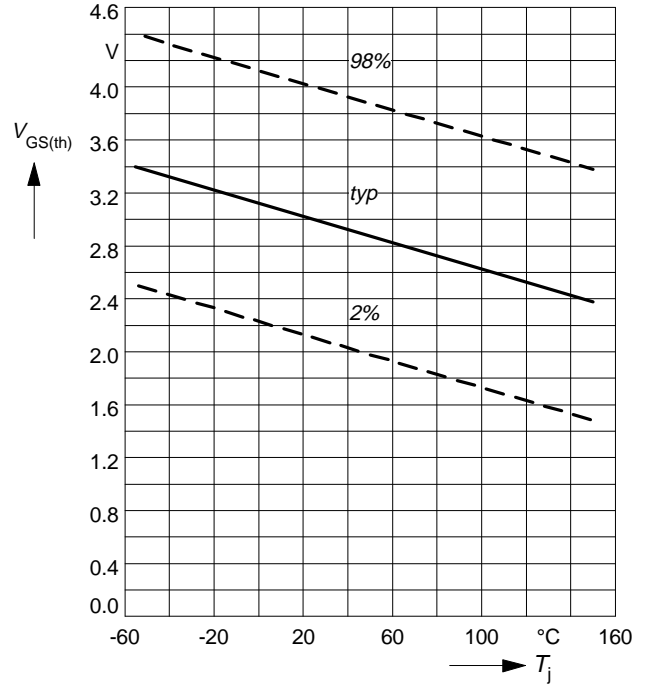

Typ. capacitances

$$C = f(V_{DS})$$

parameter: $V_{GS} = 0 \text{ V}$, $f = 1 \text{ MHz}$

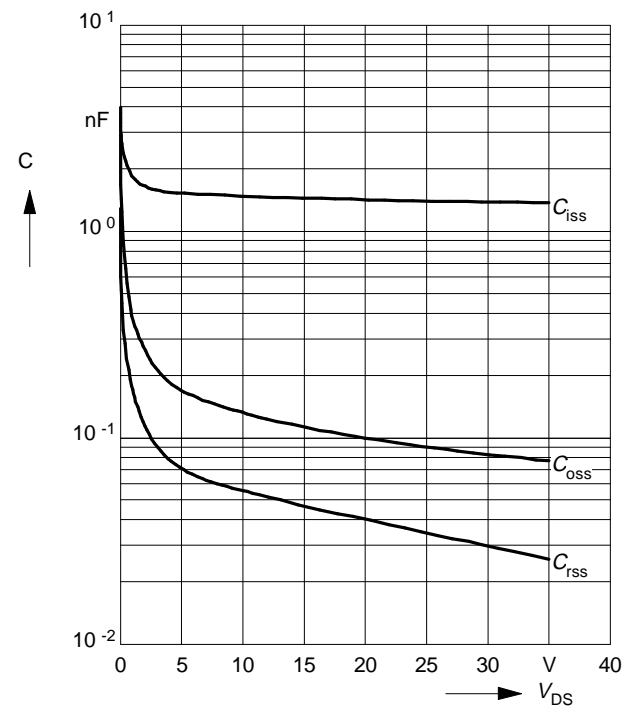

Forward characteristics of reverse diode

$$I_F = f(V_{SD})$$

parameter: T_j , $t_p = 80 \mu\text{s}$

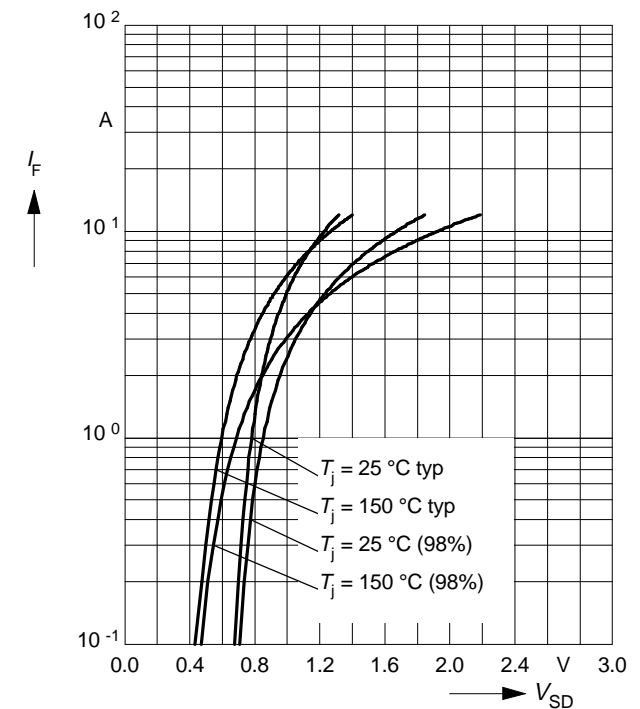

Drain-source breakdown voltage

$$V_{(BR)DSS} = f(T_j)$$

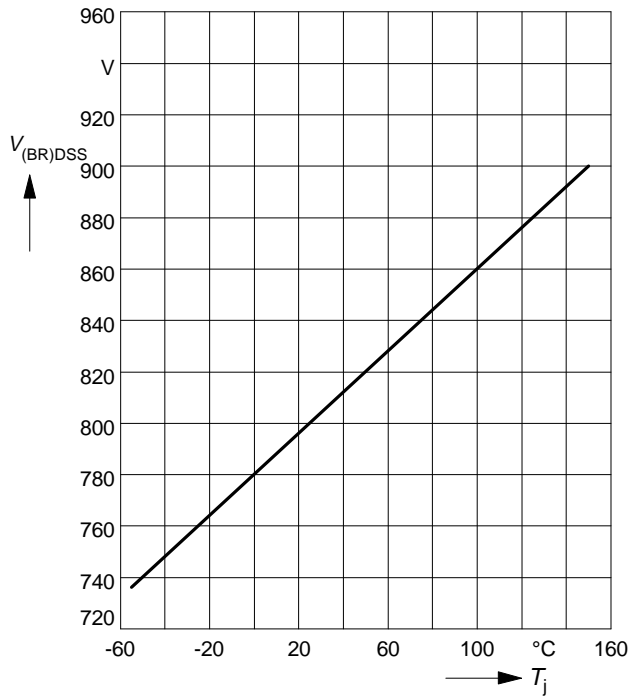

Typ. gate charge

$$V_{GS} = f(Q_{Gate})$$

parameter: $I_{D\ puls} = 5\ A$

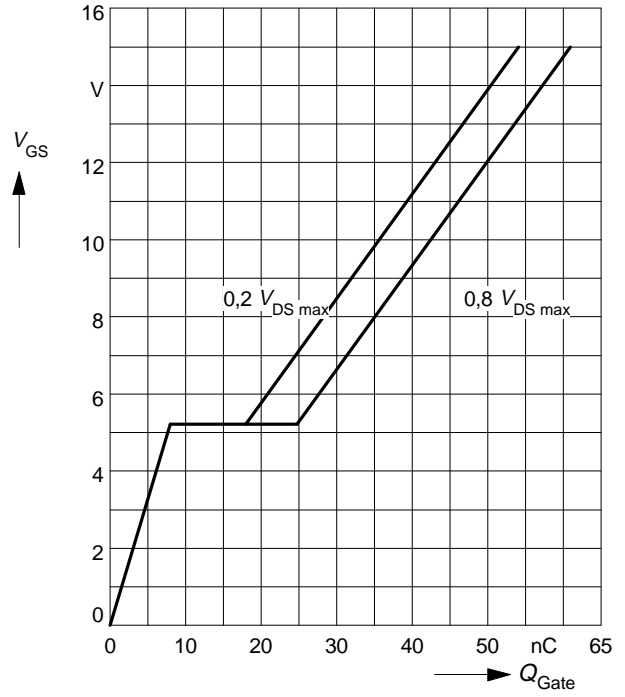

Package Outlines

TO-220 AB

Dimension in mm



- 1) punch direction, burr max. 0.04
- 2) dip finning
- 3) max. 14.5 by dip finning press burr max. 0.05