

XC6221 Series



Low ESR Caps Compatible High Speed LDO Voltage Regulators with ON/OFF Switch

- ◆ CMOS Low Power Supply Voltage Regulators
- ◆ Output Current: 200mA <Up to 250mA (TYP.)>
- ◆ Dropout Voltage: 80mV@ $I_{OUT}=100mA$, $V_{OUT(T)}=3.0V$
- ◆ Output Voltage Range: 0.8V ~ 4.0V
- ◆ Low ESR Capacitor Compatible
- ◆ High Ripple Rejection, Low Output Noise
- ◆ CL High-Speed Auto-Discharge (XC6221B)
- ◆ Ultra Small Package: USP-4

■ GENERAL DESCRIPTION

The XC6221 series are precise, low noise, high speed, low dropout regulators. They are fabricated using Torex's CMOS process. Performance features of the series include high ripple rejection and low dropout voltage, and the series include a reference voltage source, an error amplifier, a current limiter, and a phase compensation circuit.

The CE function enables the circuit to be in stand-by mode by inputting L level signal. In the stand-by mode, the series enables the electric charge at the output capacitor (CL) to be discharged via the internal auto-discharge resistance, and as a result the V_{OUT} pin quickly returns to the V_{SS} level. The series' output stabilization capacitor (CL) is also compatible with low ESR ceramic capacitors.

Output voltage is selectable in 50mV increments within a range of 0.8V~4.0V, using laser trimming technologies.

The current limiter's foldback circuit also operates as a short circuit protection for the output current limiter and the output pin. The series achieves a great response with only 25 μA of low power consumption. Also the series has low dropout voltage characteristics, which is 80mA at $I_{OUT}=100mA$ and $V_{OUT(T)}=3.0V$.

With the use of ultra small package, USP-4 package, a small footprint circuit can be designed.

■ TYPICAL APPLICATION CIRCUIT

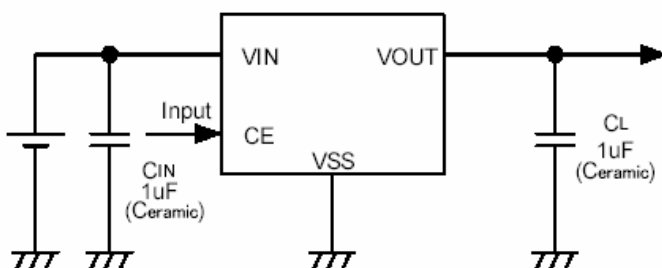

■ APPLICATIONS

- Cellular phones
- Cordless phones
- Wireless communication equipment
- Portable games
- Cameras, VCRs
- Portable AV equipment
- PDAs

■ FEATURES

Output Current	: 200mA <Up to 250mA (TYP.)>
Dropout Voltage	: 80mV@ $I_{OUT}=100mA$, $V_{OUT(T)}=3.0V$
Operating Voltage Range	: 1.6V ~ 6.0V
Output Voltage Setting Range	: 0.8V~4.0V (50mV increments)
Accuracy	: $\pm 2\%$ ($V_{OUT} \geq 1.5V$) $\pm 30mV$ ($V_{OUT} \leq 1.45V$)
Low Power Consumption	: 25 μA (TYP.)
Standby Current	: Less than 0.1 μA
High Ripple Rejection	: 70dB @ 1kHz
Operating Temperature Range	: -40°C~85°C
Low ESR Capacitor	: 1.0 μF Ceramic capacitor compatible
Ultra Small Packages	: USP-4, SOT-25, SSOT-24

■ TYPICAL PERFORMANCE CHARACTERISTICS

● Load Transient Response

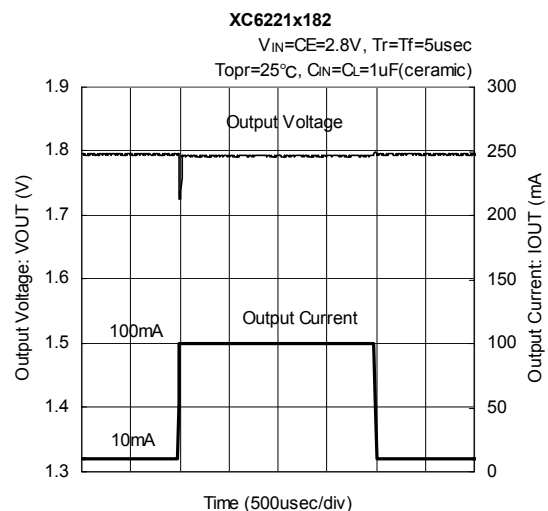

■ PIN CONFIGURATION

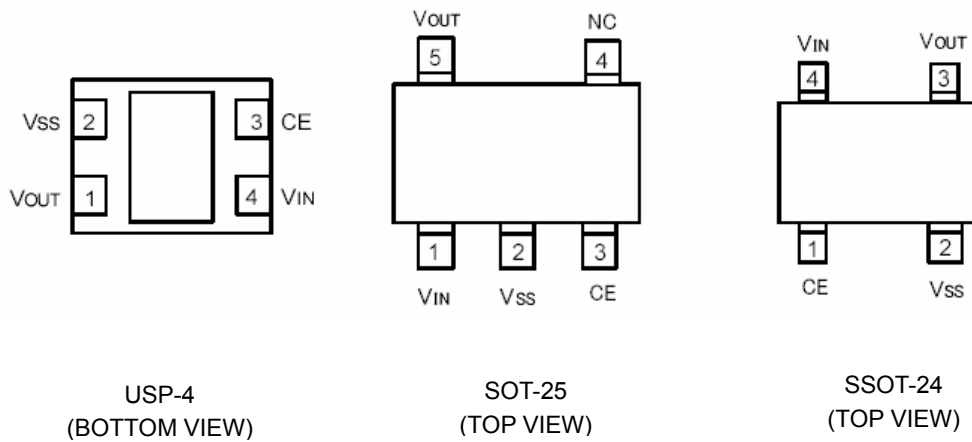

*The heat dissipation pad of the USP-4 package is recommended to solder as the recommended mount pattern and metal mask pattern for mounting strength. The mount pattern should be electrically opened or connected to the VSS (#2) pin.

■ PIN ASSIGNMENT

PIN NUMBER			PIN NAME	FUNCTIONS
USP-4	SOT-25	SSOT-24		
4	1	4	VIN	Power Input
1	5	3	VOUT	Output
2	2	2	VSS	Ground
3	3	1	CE	ON/OFF Control
-	4	-	NC	No Connection

■ PRODUCT CLASSIFICATION

● Ordering Information

XC6221 ①②③④⑤⑥

DESIGNATOR	DESCRIPTION	SYMBOL	DESCRIPTION
①	Type of Regulator	A	: CE High Active, no CL discharge resistor
		B	: CE High Active, with CL discharge resistor
② ③	Output Voltage	08 ~ 40	: ex.) $V_{OUT}(T) = 3.0V \rightarrow$ ② = 3, ③ = 0
④	Output Accuracy	2	: 100mV increments, When $0.8V \leq V_{OUT}(T) \leq 1.40V$: $V_{OUT}(T) \pm 30mV$ ex.) $0.8V \rightarrow$ ②=0, ③=8, ④=2
			: 100mV increments, When $V_{OUT}(T) \geq 1.5V$: +2% ex.) $1.5V \rightarrow$ ②=1, ③=5, ④=2
		A	: 50mV increments, When $0.85V \leq V_{OUT}(T) \leq 1.45V$: $V_{OUT}(T) \pm 30mV$ ex.) $0.85V \rightarrow$ ②=0, ③=8, ④=A
			: 50mV increments, When $V_{OUT}(T) \geq 1.55V$: +2% ex.) $1.55V \rightarrow$ ②=1, ③=5, ④=A
		1	: 100mV increments, When $0.8V \leq V_{OUT}(T) \leq 1.90V$ in HS mode: $V_{OUT}(T) \pm 20mV$ ex.) $0.8V \rightarrow$ ②=0, ③=8, ④=1
			: 100mV increments, When $V_{OUT}(T) \geq 2.0V$: +1% ex.) $2.0V \rightarrow$ ②=2, ③=0, ④=1
B	: 50mV increments, When $0.85V \leq V_{OUT}(T) \leq 1.95V$: $V_{OUT}(T) \pm 20mV$ ex.) $0.85V \rightarrow$ ②=0, ③=8, ④=B		
	: 50mV increments, When $V_{OUT}(T) \geq 2.0V$: +1% ex.) $2.05V \rightarrow$ ②=2, ③=0, ④=B		
⑤	Package	G	: USP-4
		M	: SOT-25
		N	: SSOT-24
⑥	Device Orientation	R	: Embossed tape, standard feed
		L	: Embossed tape, reverse feed

XC6221 Series

■ PACKAGING INFORMATION

● USP-4

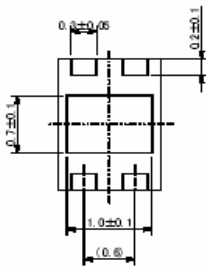
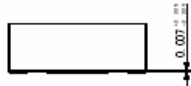
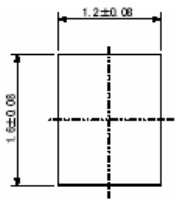

* Soldering fillet surface is not formed because the sides of the pins are plated.

● SOT-25 (SOT-23-5)

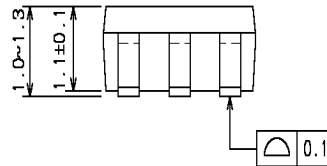
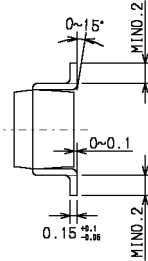
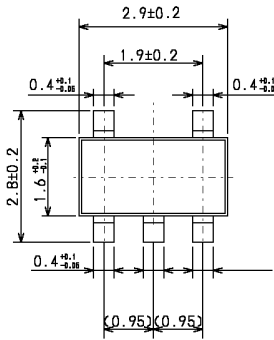

● SSOT-24

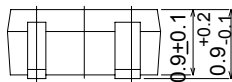
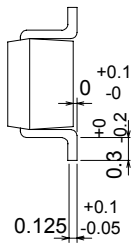
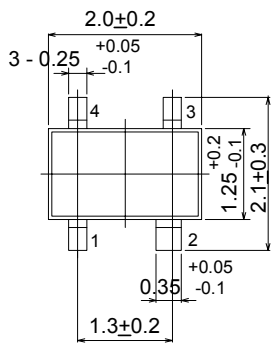

■ BLOCK DIAGRAMS

● XC6221A Series

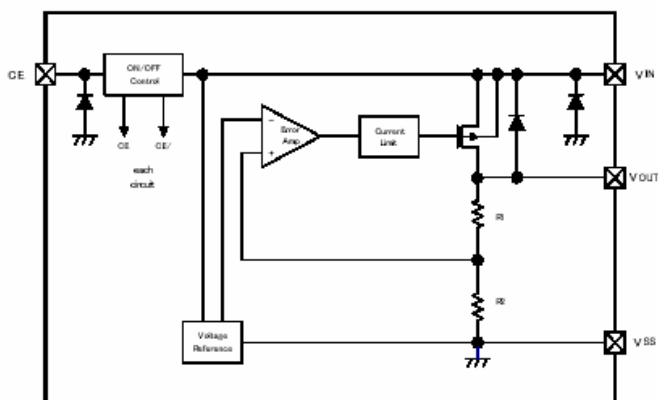

● XC6221B Series

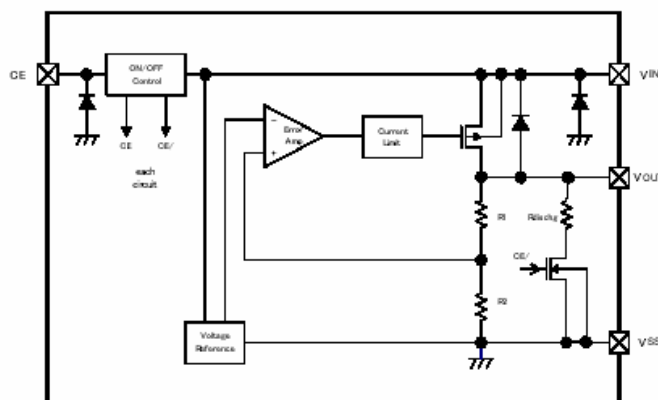

*Diodes inside the circuit are an ESD protection diode and a parasitic diode.

■ ABSOLUTE MAXIMUM RATINGS

Ta=25°C			
PARAMETER	SYMBOL	RATINGS	UNITS
Input Voltage	V _{IN}	V _{SS} - 0.3 ~ +6.5	V
Output Current	I _{OUT}	400 *1	mA
Output Voltage	V _{OUT}	V _{SS} - 0.3 ~ V _{IN} + 0.3	V
CE/GO Input Voltage	V _{CE/VGO}	V _{SS} - 0.3 ~ +6.5	V
Power Dissipation	USP-4	120	mW
	SOT-25	250	
	SSOT-24	150	
Operational Temperature Range	T _{opr}	- 40 ~ + 85	°C
Storage Temperature Range	T _{stg}	- 55 ~ +125	°C

*1: I_{OUT} = Less than Pd / (V_{IN} - V_{OUT})

ELECTRICAL CHARACTERISTICS

XC6221A/B series

Ta=25°C

PARAMETER	SYMBOL	CONDITIONS	MIN.	TYP.	MAX.	UNITS	CIRCUIT
Output Voltage	V _{OUT(E)} (* 2)	V _{OUT(T)} ≥ 1.5V, V _{CE} =V _{IN} , I _{OUT} =10mA	x 0.98 (*3)	V _{OUT(T)} (*4)	x 1.02 (*3)	V	1
		V _{OUT} ≤ 1.45V, V _{CE} =V _{IN} , I _{OUT} =10mA	-0.03 (*3)		+0.03 (*3)		
Output Voltage (High Accuracy)	V _{OUT(E)} (* 2)	V _{OUT(T)} ≥ 2.0V, V _{CE} =V _{IN} , I _{OUT} =10mA	x0.99 (*3)	V _{OUT(T)} (*4)	x1.01 (*3)	V	1
		V _{OUT(T)} ≤ 1.95V, V _{CE} =V _{IN} , I _{OUT} =10mA	-0.02 (*3)		+0.02 (*3)		
Output Current	I _{OUTMAX}	V _{CE} =V _{IN} , V _{IN} =V _{OUT(T)} +1.0V, 0.8V ≤ V _{OUT(T)} ≤ 1.15V	120	200	-	mA	1
		V _{CE} =V _{IN} , V _{IN} =V _{OUT(T)} +1.0V, 1.20V ≤ V _{OUT(T)} ≤ 1.55V	180	250	-		
		V _{CE} =V _{IN} , V _{IN} =V _{OUT(T)} +1.0V, 1.6V ≤ V _{OUT(T)}	200	250	-		
Load Regulation	ΔV _{OUT}	V _{CE} =V _{IN} , 0.1mA ≤ I _{OUT} ≤ 100mA	-	10	40	mV	1
Dropout Voltage (*5)	V _{dif}	V _{CE} =V _{IN} , I _{OUT} =100mA	E-2			mV	1
Supply Current	I _{SS1}	V _{IN} =V _{OUT} +1.0V, I _{OUT} =0mA	-	25	50	μA	2
Standby Current	I _{STBY}	V _{IN} =6.0V, V _{CE} =V _{SS}	-	0.01	0.10	μA	2
Line Regulation	$\frac{\Delta V_{OUT}}{\Delta V_{IN} \cdot V_{OUT}}$	V _{OUT(T)} +0.5V ≤ V _{IN} ≤ 6.0V : V _{OUT(T)} ≥ 1.1V, V _{CE} =V _{IN} , I _{OUT} =10mA	-	0.01	0.20	%V	1
		1.6V ≤ V _{IN} ≤ 6.0V : V _{OUT(T)} ≤ 1.05V, V _{CE} =V _{IN} , I _{OUT} =10mA					
Input Voltage	V _{IN}		1.6	-	6.0	V	1
Output Voltage Temperature Characteristics	$\frac{\Delta V_{OUT}}{\Delta T_a \cdot V_{OUT}}$	V _{CE} =V _{IN} , I _{OUT} =30mA, -40°C ≤ T _a ≤ 85°C	-	± 100	-	ppm/°C	1
Ripple Rejection Rate	PSRR	V _{IN} ={V _{OUT(T)} +1.0}V _{DC} +0.5V _{p-pAC} : V _{OUT(T)} ≥ 0.85V V _{CE} =V _{IN} , I _{OUT} =30mA, f=1kHz	-	70	-	dB	3
		V _{IN} =1.85V _{DC} +0.5V _{p-pAC} , V _{OUT(T)} ≤ 0.8V, V _{CE} =V _{IN} , I _{OUT} =30mA, f=1kHz					
Limit Current	I _{lim}	V _{CE} =V _{IN}	200	250	-	mA	1
Short Current	I _{short}	V _{CE} =V _{IN} , V _{OUT} is short-circuited at the V _{SS} level.	-	30	-	mA	1
CE High Level Voltage	V _{CEH}		1.2	-	6.0	V	4
CE Low Level Voltage	V _{CEL}		-	-	0.3	V	4
CE High Level Current	I _{CEH}	V _{CE} =V _{IN}	-0.1	-	0.1	μA	4
CE Low Level Current	I _{CEL}	V _{CE} =V _{SS}	-0.1			μA	4
CL Auto-Discharge Resistance (* 8)	R _{dischg}	V _{IN} =6.0V, V _{OUT(T)} =4.0V, V _{CE} =V _{SS}	-	780	-	Ω	1

NOTE:

- * 1: Unless otherwise stated regarding input voltage conditions, V_{IN}=V_{OUT(T)}+1.0V.
- * 2: V_{OUT(E)} = Effective output voltage (Refer to the voltage chart E-0 and E-1)
(i.e. the output voltage when HS mode and an amply stabilized "V_{OUT(T)}+1.0V" is provided at the V_{IN} pin while maintaining a certain I_{OUT} value.)
- * 3: The rated value of the setting output voltage V_{OUT(E)} is shown in voltage chart E-0 and E-1)
- * 4: V_{OUT(T)} = Specified output voltage
- * 5: V_{dif}={V_{IN1}(*7)-V_{OUT1}(*6)}
- * 6: V_{OUT1}=A voltage equal to 98% of the output voltage whenever an amply stabilized I_{OUT} {V_{OUT(T)}+1.0V} is input in the HS mode.
- * 7: V_{IN1}=The input voltage when V_{OUT1} appears as input voltage is gradually decreased.
- * 8: For the XC6221B series only. The XC6221A series discharges by resistors R1 and R2 only as shown in the block diagrams.

■ OUTPUT VOLTAGE CHART

SYMBOL	E-0		E-1		E-2	
SETTING OUTPUT VOLTAGE (V)	OUTPUT VOLTAGE Standard $\pm 2\%$ (V)		OUTPUT VOLTAGE High Accuracy $\pm 1\%$ (V)		DROPOUT VOLTAGE Vdif (mV)	
VOUT(T)	VOUT(E)		VOUT(E)		Vdif	
	MIN.	MAX.	MIN.	MAX.	MIN.	MAX.
0.80	0.7700	0.8300	0.7800	0.8200	500	850
0.85	0.8200	0.8800	0.8300	0.8700		
0.90	0.8700	0.9300	0.8800	0.9200	410	750
0.95	0.9200	0.9800	0.9300	0.9700		
1.00	0.9700	1.0300	0.9800	1.0200	330	650
1.05	1.0200	1.0800	1.0300	1.0700		
1.10	1.0700	1.1300	1.0800	1.1200		
1.15	1.1200	1.1800	1.1300	1.1700		
1.20	1.1700	1.2300	1.1800	1.2200	230	410
1.25	1.2200	1.2800	1.2300	1.2700		
1.30	1.2700	1.3300	1.2800	1.3200		
1.35	1.3200	1.3800	1.3300	1.3700		
1.40	1.3700	1.4300	1.3800	1.4200	200	360
1.45	1.4200	1.4800	1.4300	1.4700		
1.50	1.4700	1.5300	1.4800	1.5200	160	290
1.55	1.5200	1.5800	1.5300	1.5700		
1.60	1.5700	1.6300	1.5800	1.6200	160	250
1.65	1.6200	1.6800	1.6300	1.6700		
1.70	1.6700	1.7300	1.6800	1.7200		
1.75	1.7200	1.7800	1.7300	1.7700		
1.80	1.7700	1.8300	1.7800	1.8200	125	210
1.85	1.8200	1.8800	1.8300	1.8700		
1.90	1.8700	1.9300	1.8800	1.9200		
1.95	1.9200	1.9800	1.9300	1.9700		
2.00	1.9600	2.0400	1.9800	2.0200	115	195
2.05	2.0090	2.0910	2.0295	2.0705		
2.10	2.0850	2.1420	2.0790	2.1210		
2.15	2.1070	2.1930	2.1285	2.1715		
2.20	2.1560	2.2440	2.1780	2.2220		
2.25	2.2050	2.2950	2.2275	2.2725		
2.30	2.2540	2.3460	2.2770	2.3230		
2.35	2.3030	2.3970	2.3265	2.3735		
2.40	2.3520	2.4480	2.3760	2.4240		
2.45	2.4010	2.4990	2.4255	2.4745		
2.50	2.4500	2.5500	2.4750	2.5250	95	170
2.55	2.4990	2.6010	2.5245	2.5755		
2.60	2.5480	2.6520	2.5740	2.6260		
2.65	2.5970	2.7030	2.6235	2.6765		
2.70	2.6460	2.7540	2.6730	2.7270		
2.75	2.6950	2.8050	2.7225	2.7775		
2.80	2.7440	2.8560	2.7720	2.8280		
2.85	2.7930	2.9070	2.8215	2.8785		
2.90	2.8420	2.9580	2.8710	2.9290		
2.95	2.8910	3.0090	2.9205	2.9795		

■ OUTPUT VOLTAGE CHART (Continued)

SYMBOL	E-0		E-1		E-2	
SETTING OUTPUT VOLTAGE (V)	OUTPUT VOLTAGE Standard $\pm 2\%$ (V)		OUTPUT VOLTAGE High Accuracy $\pm 1\%$ (V)		DROPOUT VOLTAGE Vdif (mV)	
V _{OUT(T)}	V _{OUT(E)}		V _{OUT(E)}		Vdif	
	MIN.	MAX.	MIN.	MAX.	MIN.	MAX.
3.00	2.9400	3.0600	2.9700	3.0300	80	140
3.05	2.8990	3.1100	3.0195	3.0805		
3.10	3.0380	3.1620	3.0690	3.1310		
3.15	3.0870	3.2130	3.1185	3.1815		
3.20	3.1360	3.2640	3.1680	3.2320		
3.25	3.1850	3.3150	3.2175	3.2825		
3.30	3.2340	3.3660	3.2670	3.3330		
3.35	3.2830	3.4170	3.3165	3.3835		
3.40	3.3320	3.4680	3.3660	3.4340		
3.45	3.3810	3.5190	3.4155	3.4845		
3.50	3.4300	3.570	3.4650	3.5350		
3.55	3.4790	3.6210	3.5145	3.5855		
3.60	3.5280	3.6720	3.5640	3.6360		
3.65	3.5770	3.7230	3.6135	3.6855		
3.70	3.6260	3.7740	3.6630	3.7370		
3.75	3.6750	3.8250	3.7125	3.7875		
3.80	3.7240	3.8760	3.7620	3.8380		
3.85	3.7730	3.9270	3.8115	3.8885		
3.90	3.8220	3.9780	3.8610	3.9390		
3.95	3.8710	4.0290	3.9105	3.9895		
4.00	3.9200	4.0800	3.9600	4.0400		

OPERATIONAL EXPLANATION

<Output Voltage Control>

The voltage divided by resistors R1 & R2 is compared with the internal reference voltage by the error amplifier. The P-channel MOSFET, which is connected to the V_{OUT} pin, is then driven by the subsequent output signal. The output voltage at the V_{OUT} pin is controlled & stabilized by a system of negative feedback. The current limit circuit and short protect circuit operate in relation to the level of output current. Further, the IC's internal circuitry can be shutdown via the CE pin's signal.

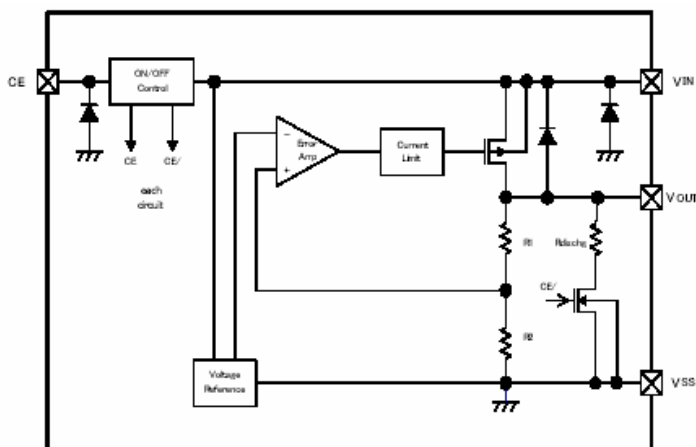

<Low ESR capacitor>

With the XC6221 series, a stable output voltage is achievable even if used with low ESR capacitors, as a phase compensation circuit is built-in. Values required for the phase compensation are as the chart below. In order to ensure the stable phase compensation while avoiding run-out of values, please use the capacitor, which does not depend on bias or temperature too much. For a stable power input, please connect an input capacitor (C_{IN}) of 1.0 μF between the V_{IN} pin and the V_{SS} pin.

SETTING OUTPUT VOLTAGE (V)	OUTPUT CAPACITOR VALUE
0.8 ~ 1.15	CL=4.7μF
1.2 ~ 1.35	CL=2.2μF
1.4 ~ 4.0	CL=1.0μF

<CL Auto-Discharge Function>

XC6221B series can discharge the electric charge in the output capacitor (CL), when a low signal to the CE pin, which enables a whole IC circuit turn off, is inputted via the N-channel transistor located between the V_{OUT} pin and the V_{SS} pin (cf. BLOCK DIAGRAM). The CL auto-discharge resistance value is set at 780 Ω (V_{OUT}=4.0V @ V_{IN}=6.0V at typical). The discharge time of the output capacitor (CL) is set by the CL auto-discharge resistance (R) and the output capacitor (CL). By setting time constant of a CL auto-discharge resistance value [Rdischg] and an output capacitor value (CL) as τ ($\tau = C \times R_{dischg}$), the output voltage after discharge via the N-channel transistor is calculated by the following formulas.

$$V = V_{OUT(E)} \times e^{-t/\tau}, \text{ or } t = \tau \ln (V / V_{OUT(E)})$$

(V : Output voltage after discharge, V_{OUT(E)} : Output voltage, t: Discharge time,
 τ : CL auto-discharge resistance Rdischg × Output capacitor (CL) value C)

■ OPERATIONAL EXPLANATION (Continued)

<Current Limiter, Short-Circuit Protection>

The XC6221 series' foldback circuit operates as an output current limiter and a short protection of the output pin. When the load current reaches the current limit level, the fixed current limiter circuit operates and output voltage drops. When the output pin is shorted to the V_{SS} level, a current of about 30mA flows.

<CE Pin>

The IC's internal circuitry can be shutdown via the signal from the CE pin with the XC6221 series. In shutdown mode, output at the V_{OUT} pin will be pulled down to the V_{SS} level via R1 & R2. However, as for the XC6221B series, the C_L auto-discharge resistor is connected in parallel to R1 and R2 while the power supply is applied to the V_{IN} pin. Therefore, time until the V_{OUT} pin reaches the V_{SS} level becomes short. The output voltage becomes unstable, when the CE pin is open. If this IC is used with the correct output voltage for the CE pin, the logic is fixed and the IC will operate normally. However, supply current may increase as a result of through current in the IC's internal circuitry when medium voltage is input.

■ NOTES ON USE

1. Please use this IC within the stated absolute maximum ratings. The IC is liable to malfunction should the ratings be exceeded.
2. Where wiring impedance is high, operations may become unstable due to noise and/or phase lag depending on output current. Please wire the input capacitor (C_{IN}) and the output capacitor (C_L) as close to the IC as possible.

■ TEST CIRCUITS

Circuit 1: Output Voltage, Output Current, Dropout Voltage, Input/Operating Voltage, Line Regulation, Load Regulation, Current Limit, Short Current, CL Discharge Resistance

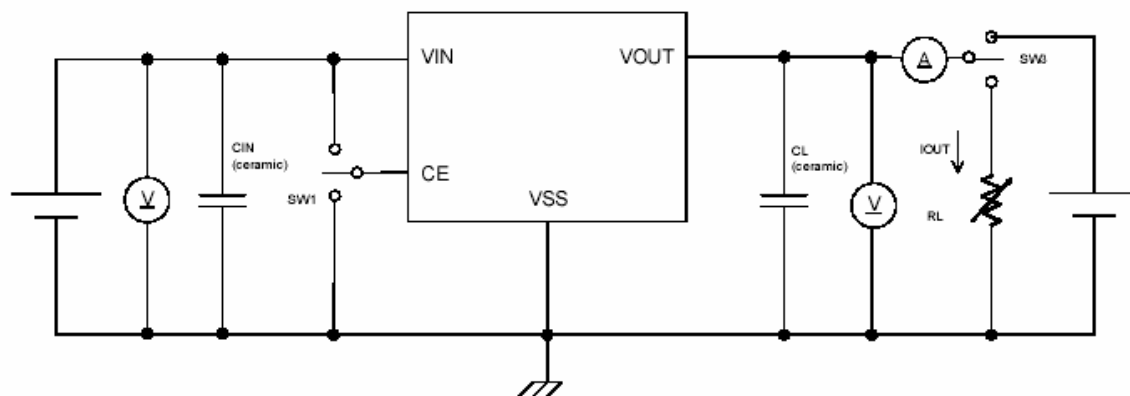

Circuit 2: Supply Current, Standby Current

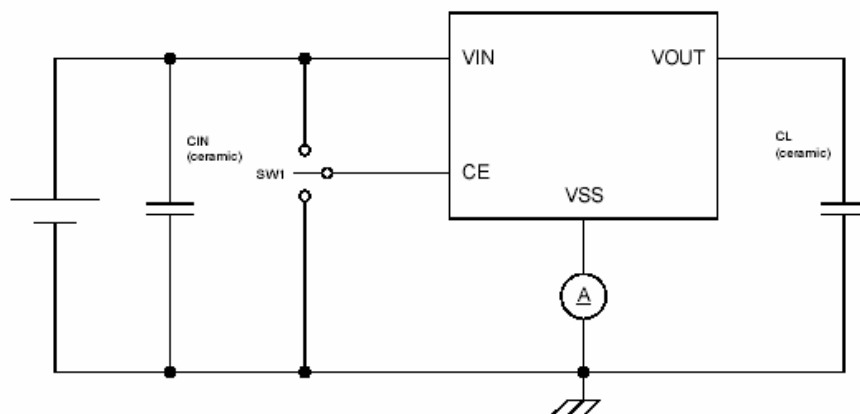

Circuit 3: Ripple Rejection Rate

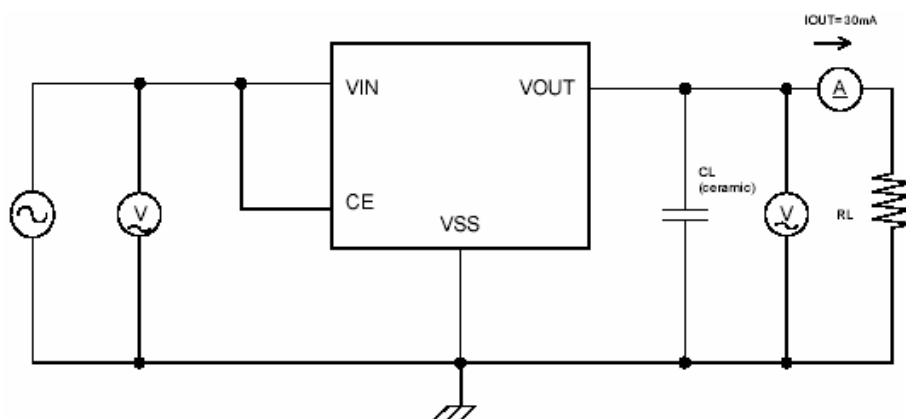

■ TEST CIRCUITS (Continued)

Circuit 4: CE "H" "L" Level Voltage, CE "H" "L" Level Current

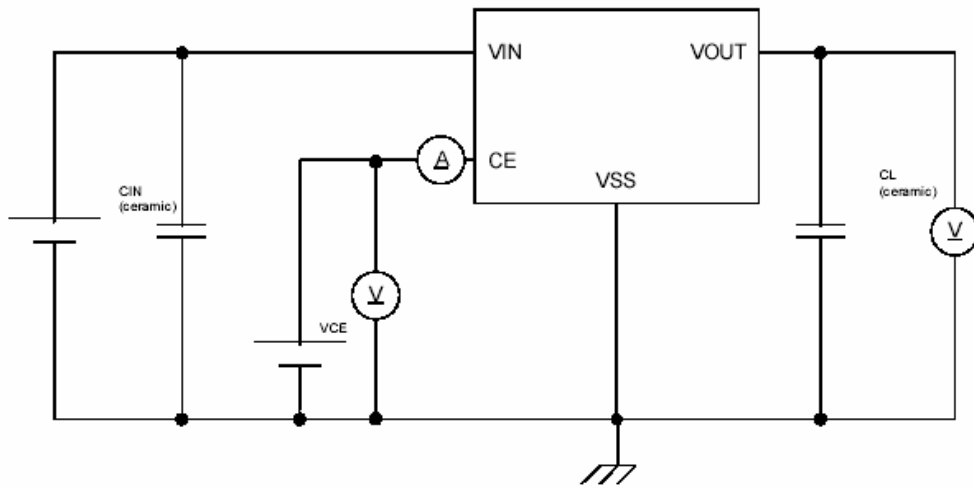

■ TYPICAL PERFORMANCE CHARACTERISTICS (Continued)

(1) Output Voltage vs. Output Current

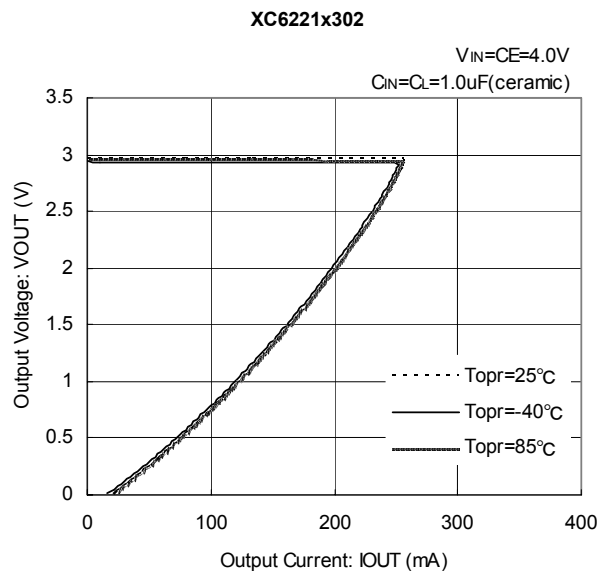
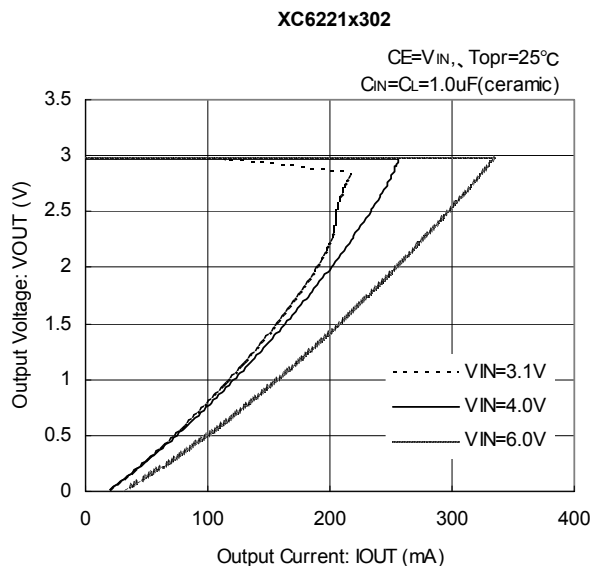
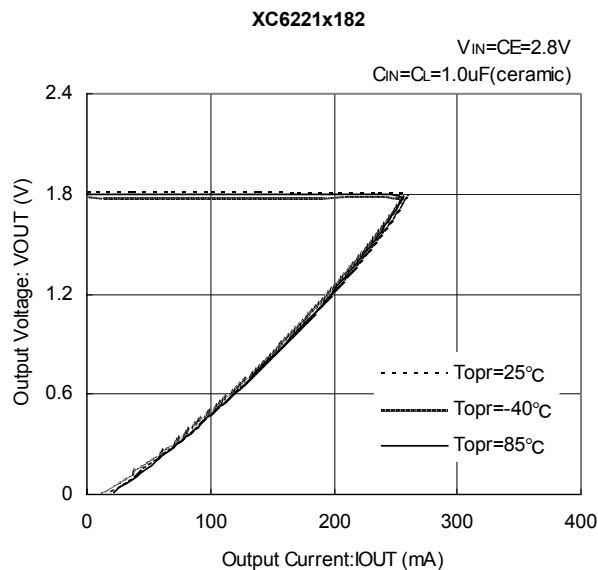
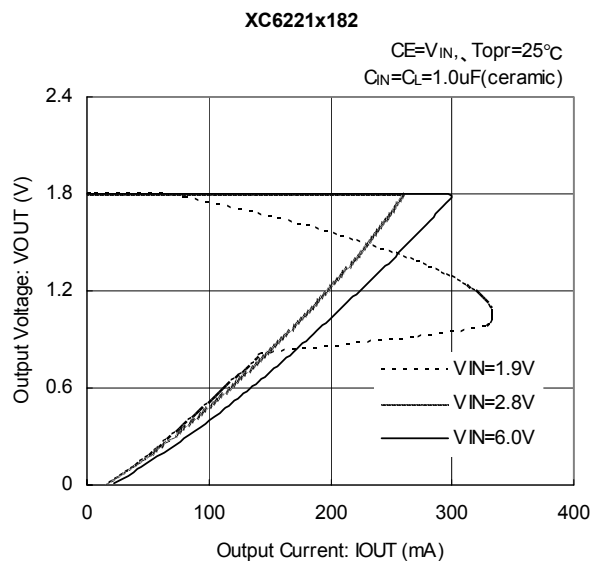

(2) Output Voltage vs. Input Voltage

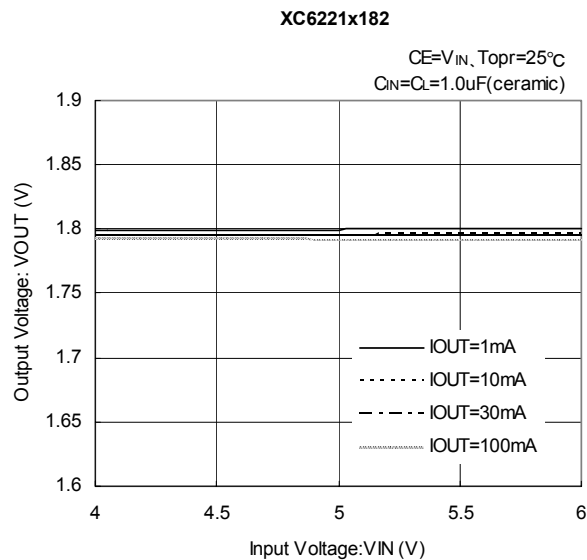
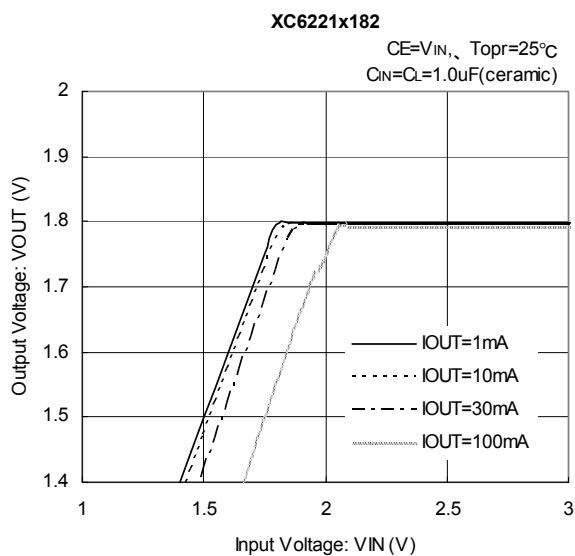

■ TYPICAL PERFORMANCE CHARACTERISTICS (Continued)

(2) Output Voltage vs. Input Voltage (Continued)

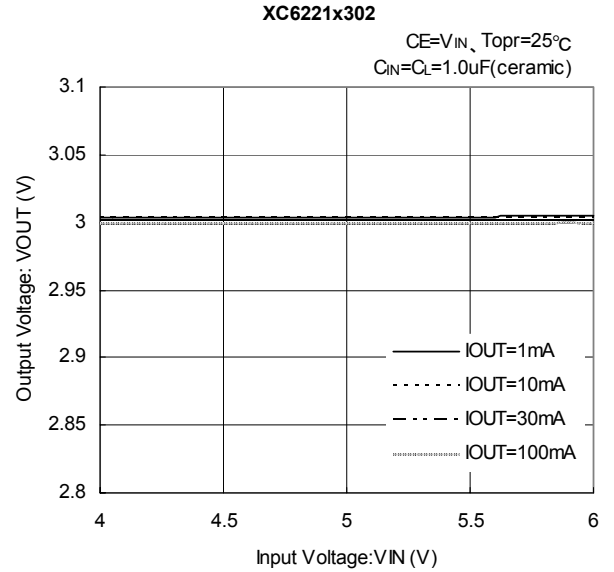
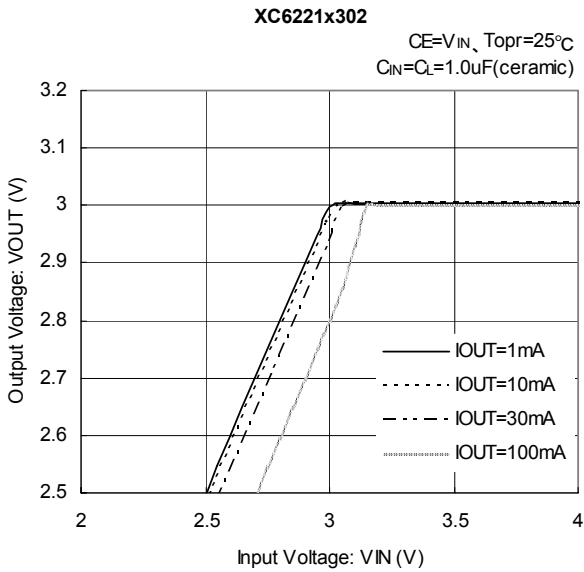

(3) Dropout Voltage

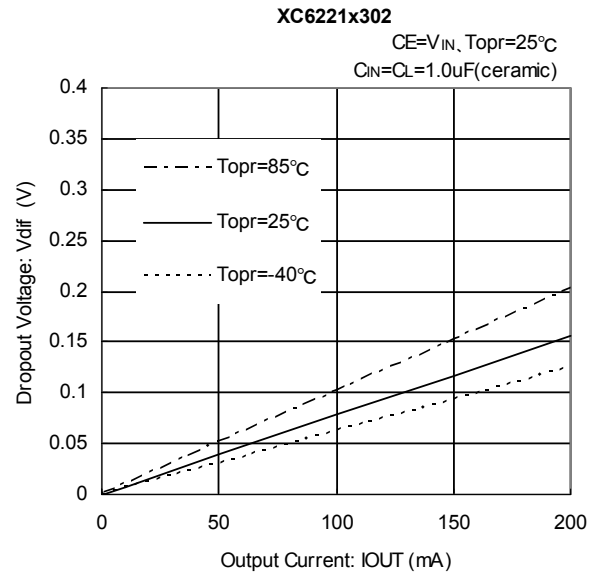
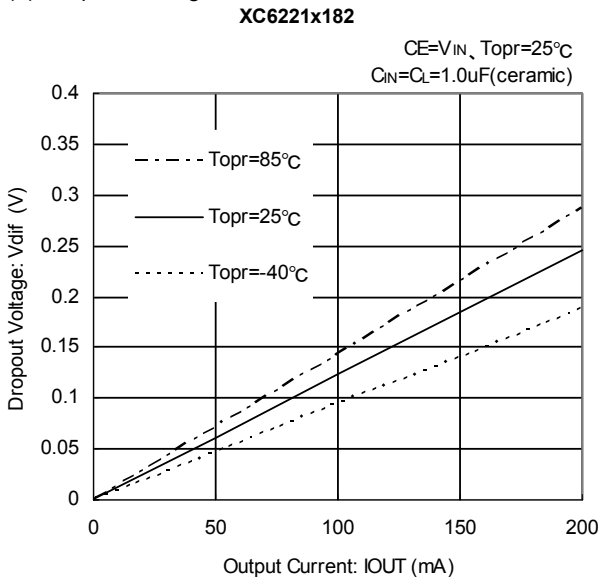

(4) Output Voltage vs. Ambient Temperature

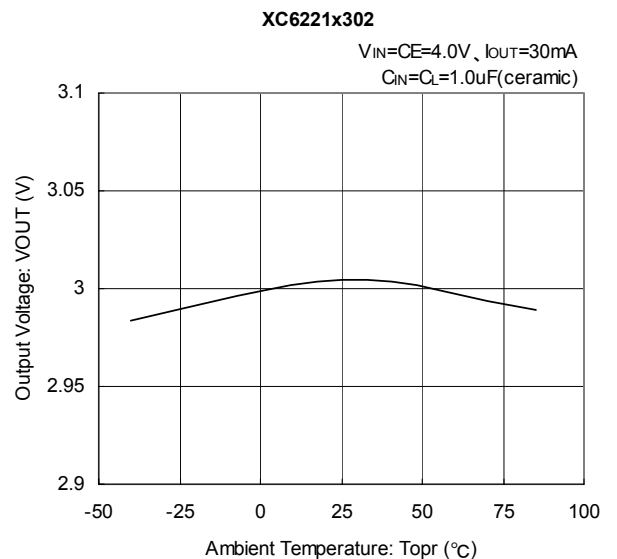
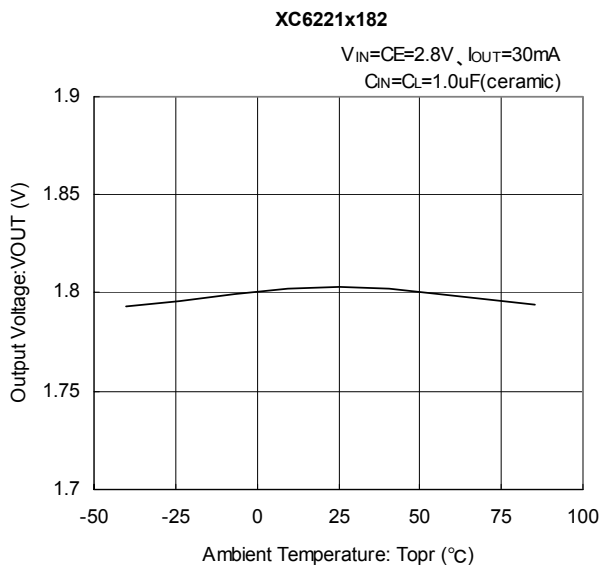

■ TYPICAL PERFORMANCE CHARACTERISTICS (Continued)

(5) Supply Current vs. Input Voltage

XC6221x182

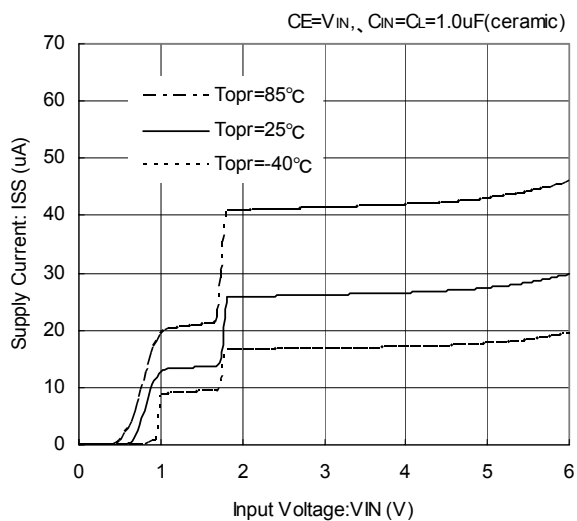

XC6221x302

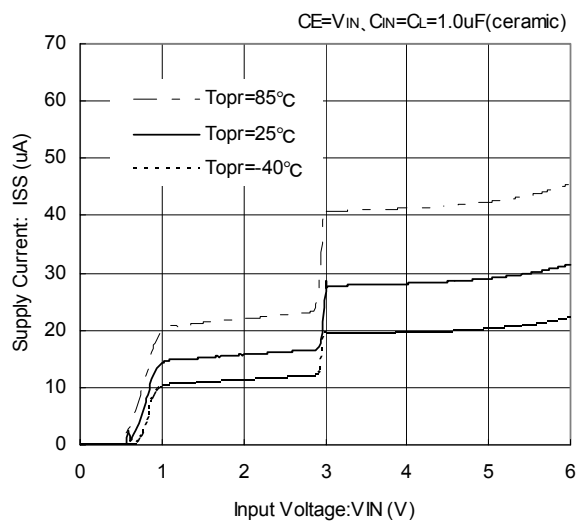

(6) CL-Discharge Resistance vs. Ambient Temperature

XC6221B

V_{IN}=6.0V, CE=V_{SS}, V_{OUT}=4.0V

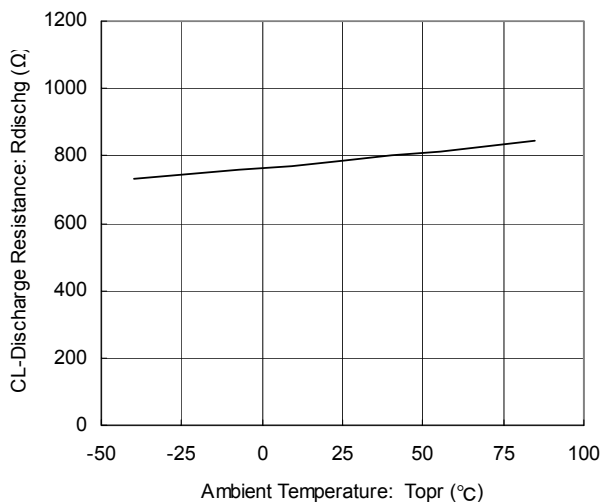

(7) Load Transient Response

XC6221x182

V_{IN}=CE=2.8V, Tr=Tf=5uSec
Topr=25°C, C_{IN}=C_L=1uF(ceramic)

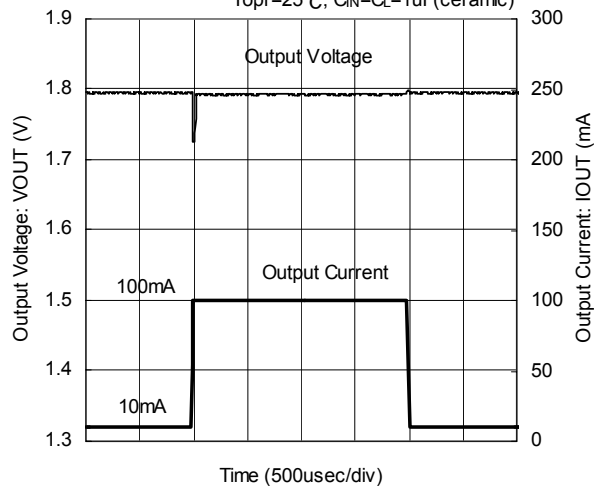

XC6221x302

V_{IN}=CE=4.0V, Tr=Tf=5uSec
Topr=25°C, C_{IN}=C_L=1uF(ceramic)

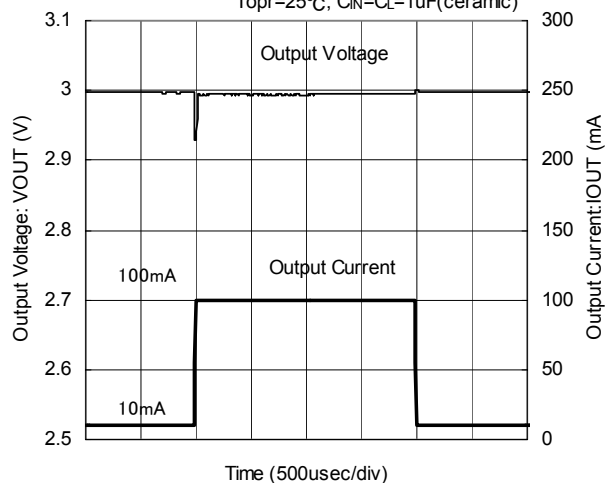

TYPICAL PERFORMANCE CHARACTERISTICS (Continued)

(8) Line Transient Response

XC6221x182

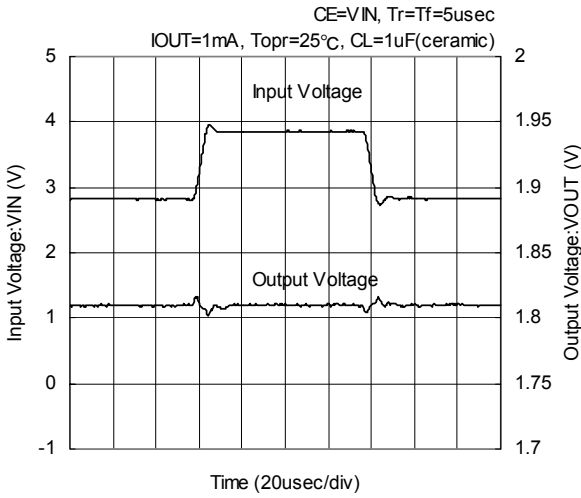

XC6221x182

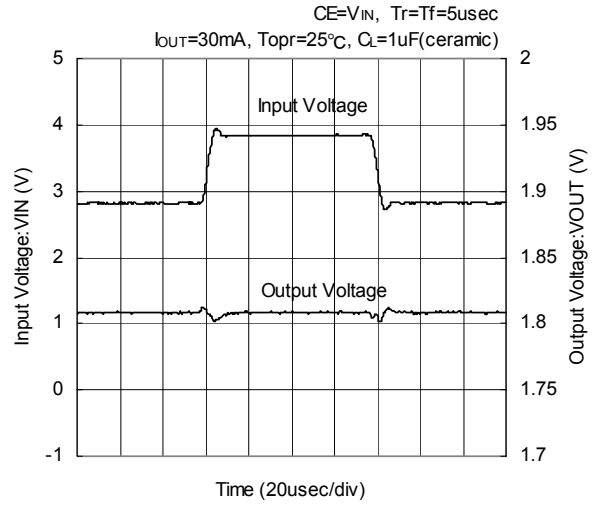

XC6221x182

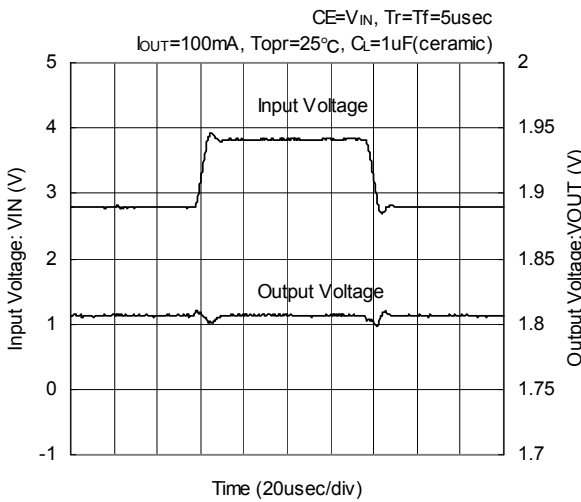

XC6221x302

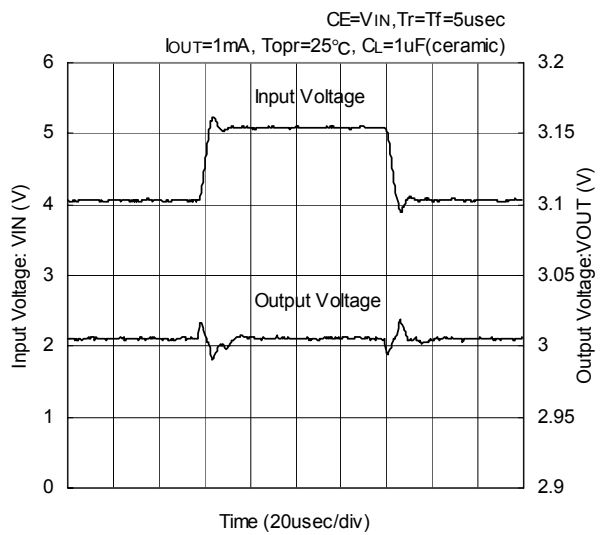

XC6221x302

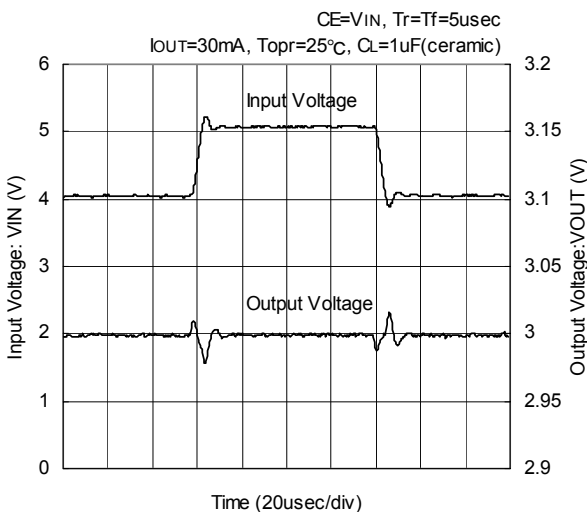

XC6221x302

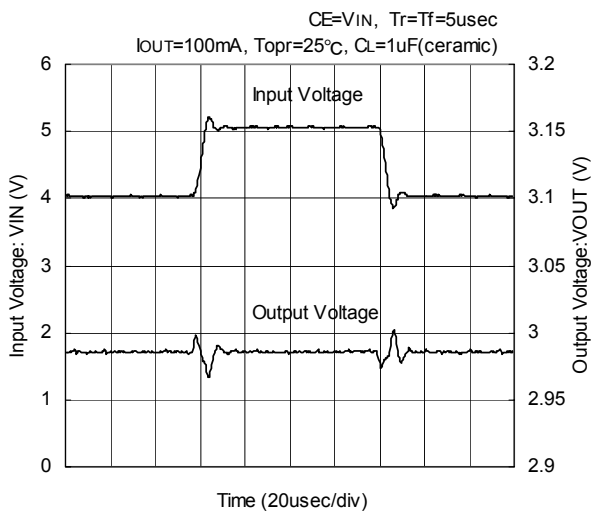

■ TYPICAL PERFORMANCE CHARACTERISTICS (Continued)

(9) Input Rise Characteristics

XC6221x182xx

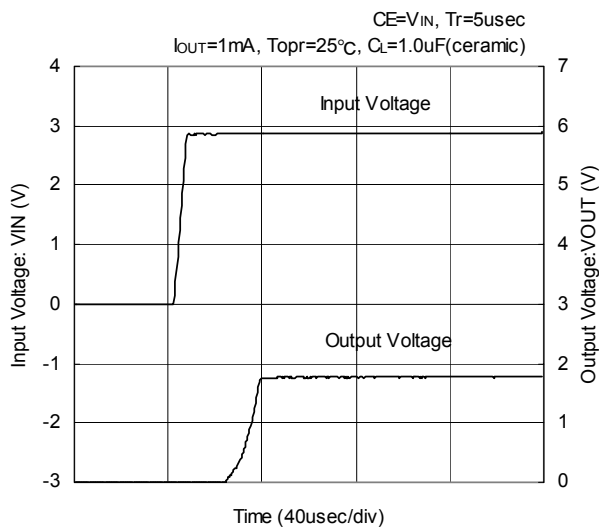

XC6221x182xx

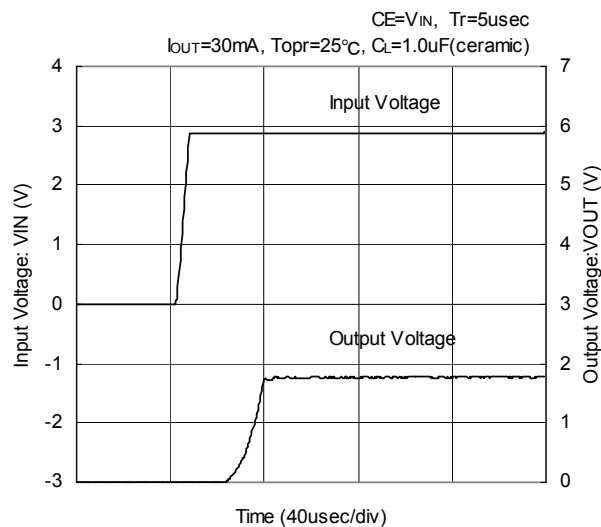

XC6221x182

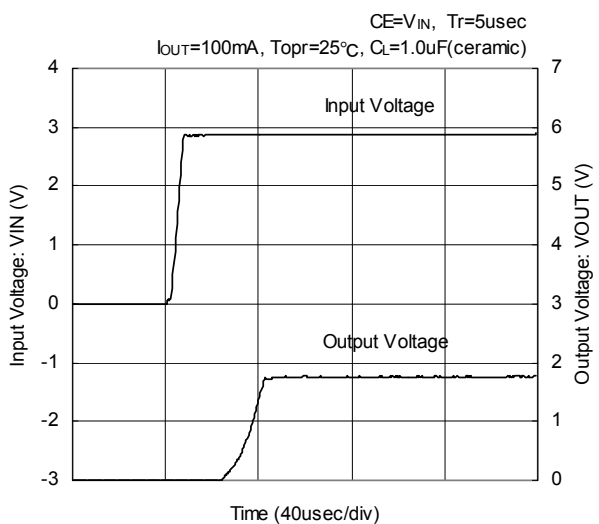

XC6221x302

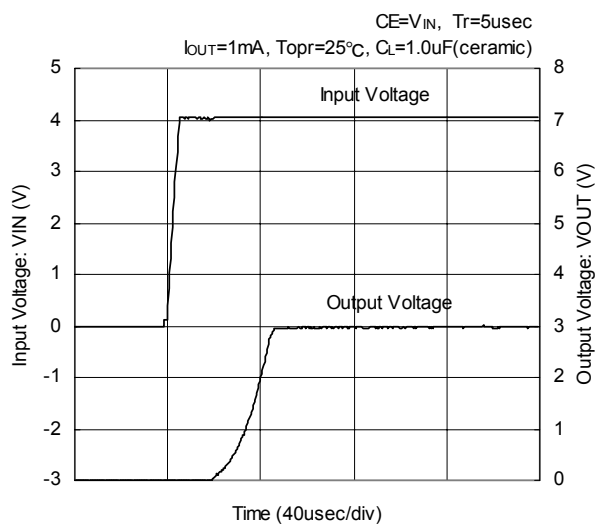

XC6221x302

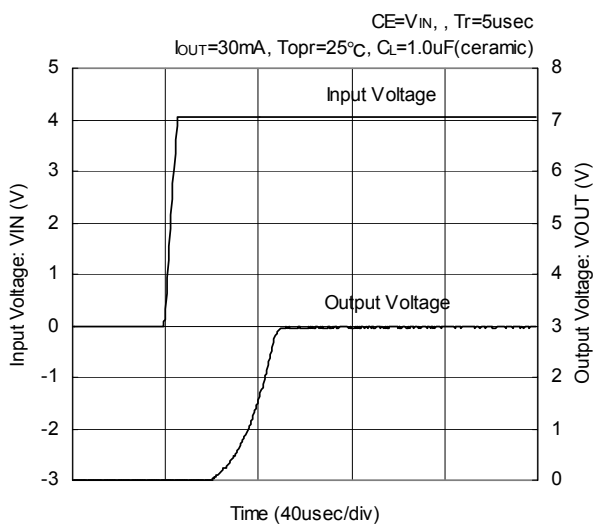

XC6221x302

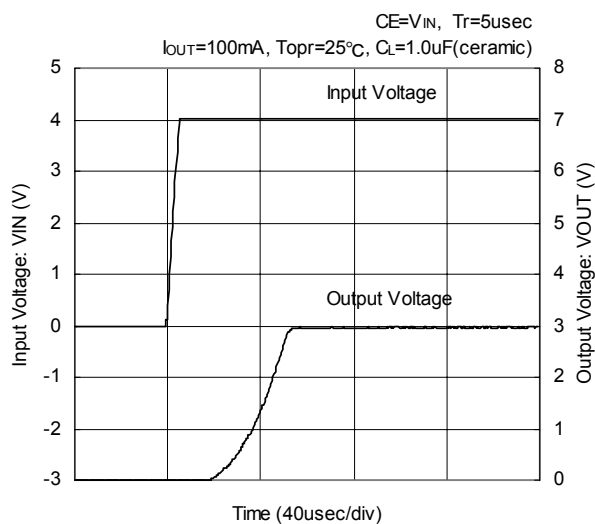

■ TYPICAL PERFORMANCE CHARACTERISTICS (Continued)

(10) CE Rise Characteristics

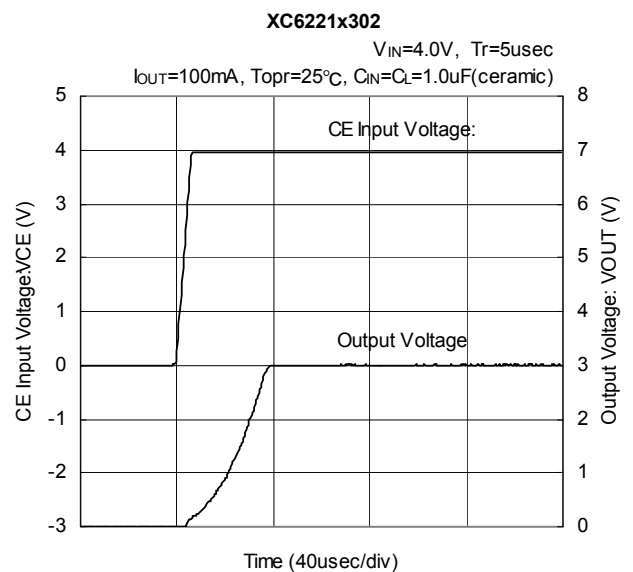
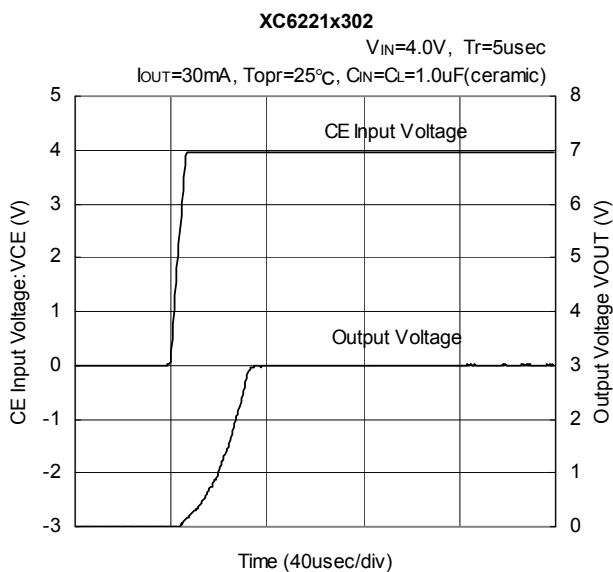
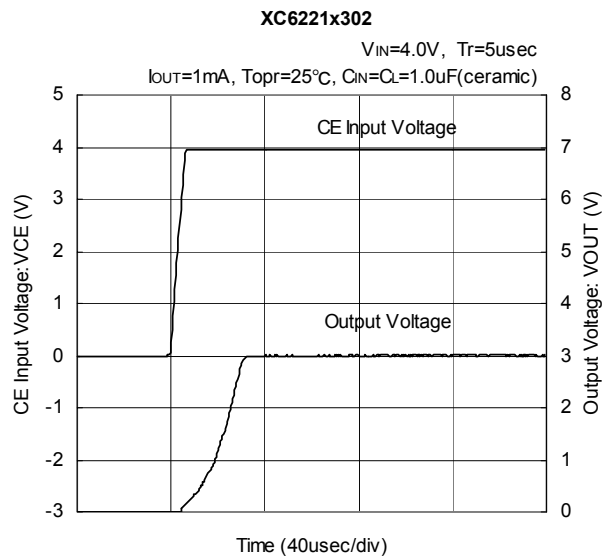
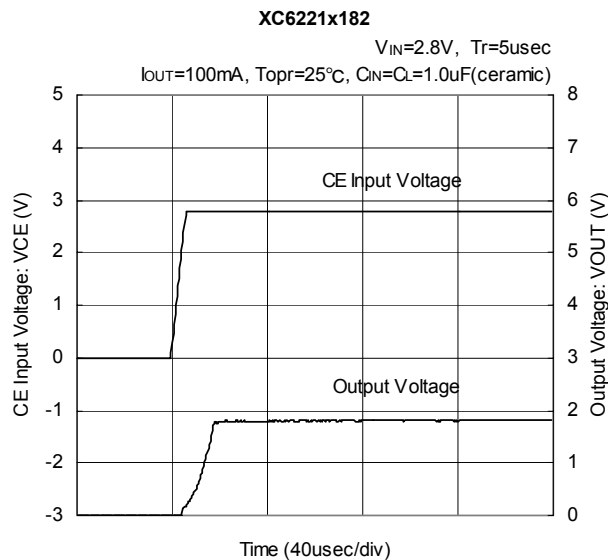
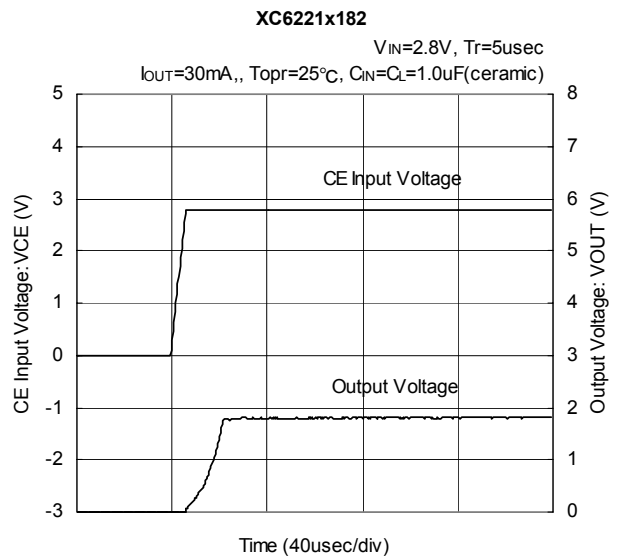
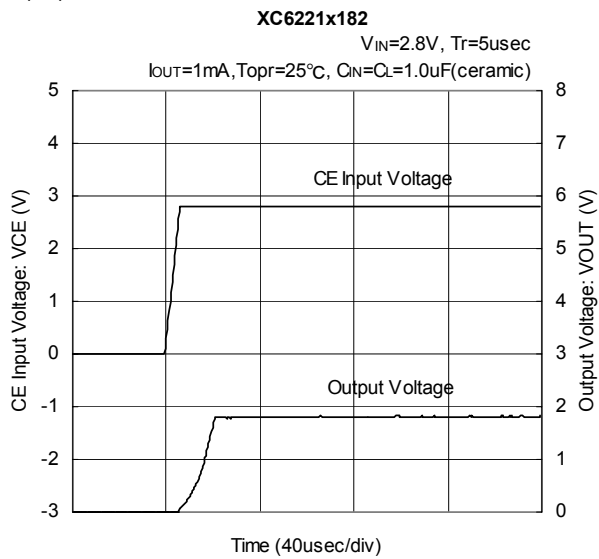

■ TYPICAL PERFORMANCE CHARACTERISTICS (Continued)

(11) Ripple Rejection Rate

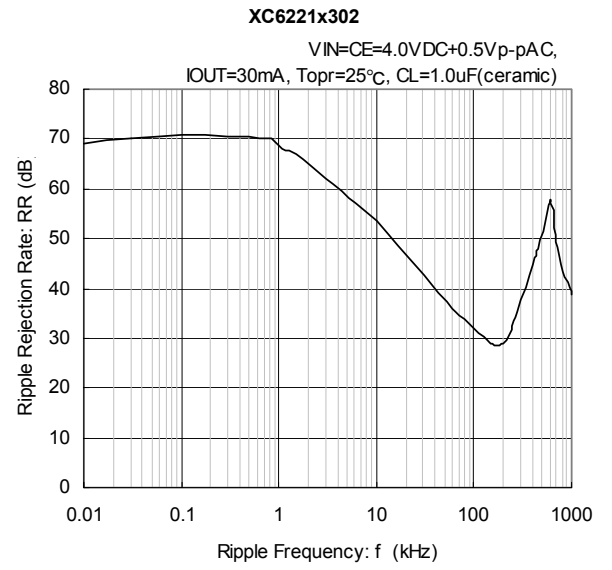
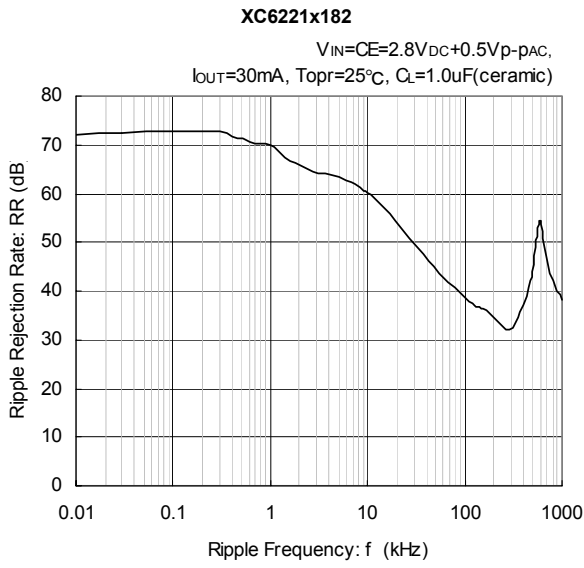

1. The products and product specifications contained herein are subject to change without notice to improve performance characteristics. Consult us, or our representatives before use, to confirm that the information in this catalog is up to date.
2. We assume no responsibility for any infringement of patents, patent rights, or other rights arising from the use of any information and circuitry in this catalog.
3. Please ensure suitable shipping controls (including fail-safe designs and aging protection) are in force for equipment employing products listed in this catalog.
4. The products in this catalog are not developed, designed, or approved for use with such equipment whose failure or malfunction can be reasonably expected to directly endanger the life of, or cause significant injury to, the user.
(e.g. Atomic energy; aerospace; transport; combustion and associated safety equipment thereof.)
5. Please use the products listed in this catalog within the specified ranges.
Should you wish to use the products under conditions exceeding the specifications, please consult us or our representatives.
6. We assume no responsibility for damage or loss due to abnormal use.
7. All rights reserved. No part of this catalog may be copied or reproduced without the prior permission of Torex Semiconductor Ltd.

TOREX SEMICONDUCTOR LTD.