

Typical Applications

This HMC772LC4 is ideal for:

- Wideband Communication Systems
- Surveillance Systems
- Point-to-Point Radios
- Point-to-Multi-Point Radios
- Military & Space
- Test Instrumentation

Functional Diagram

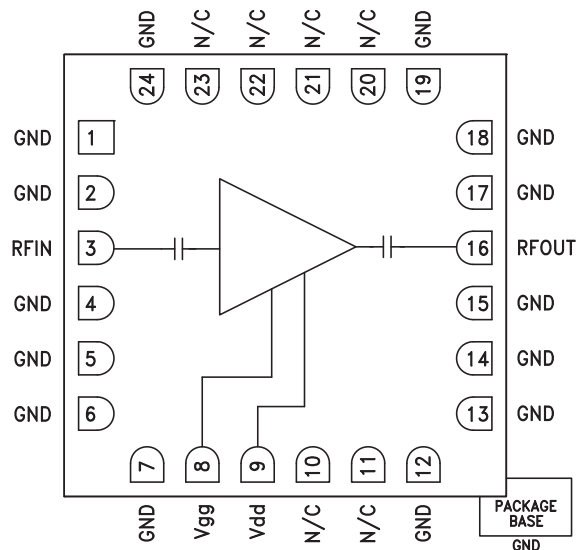

Features

- Noise Figure: 1.8 dB
- Gain: 15 dB
- Output IP3: +25 dBm
- P1dB Output Power: +13 dBm
- 50 Ohm Matched Input/Output
- Supply Voltage: +4V @ 45 mA
- 24 Lead Ceramic 4x4mm SMT Package: 16mm²

General Description

The HMC772LC4 is a GaAs MMIC HEMT Low Noise Wideband Amplifier which operates between 2 and 12 GHz. The amplifier provides 15 dB of gain, 1.8 dB noise figure up to 12 GHz and output IP3 of +25 dBm, while requiring only 45 mA from a +4V supply voltage. The Psat output power of up to +15 dBm enables the LNA to function as a LO driver for many of Hittite's balanced, I/Q or image reject mixers. The HMC772LC4 also features I/Os that are DC blocked and internally matched to 50 Ohms, making it ideal for SMT based high capacity microwave radio applications. The HMC772LC4 is housed in a RoHS compliant 4x4 mm QFN leadless ceramic package.

Electrical Specifications, $T_A = +25^\circ C$, $V_{dd} = +4V$, $I_{dd} = 45 mA^*$

Parameter	Min.	Typ.	Max.	Units
Frequency Range	2 - 12			GHz
Gain	14	15		dB
Gain Variation over Temperature		0.01		dB / °C
Noise Figure		1.8	2.5	dB
Input Return Loss		15		dB
Output Return Loss		15		dB
Output Power for 1 dB Compression		13		dBm
Output Third Order Intercept (IP3)		25		dBm
Supply Current (I _{dd}) (V _{dd} = 4V, V _{gg} = -0.2V Typ.)*		45		mA

* Adjust V_{gg} between -1 to 0.3V to achieve I_{dd} = 45mA typical.

Gain vs. Temperature

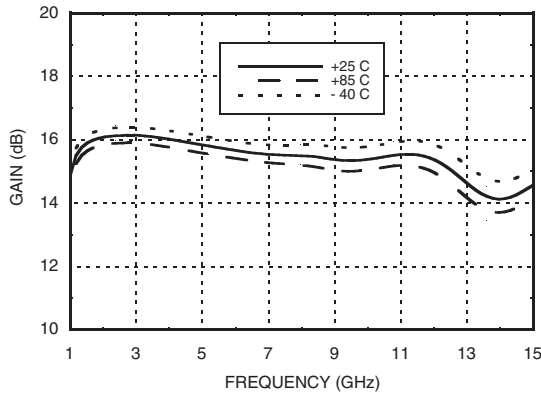

Noise Figure vs. Temperature

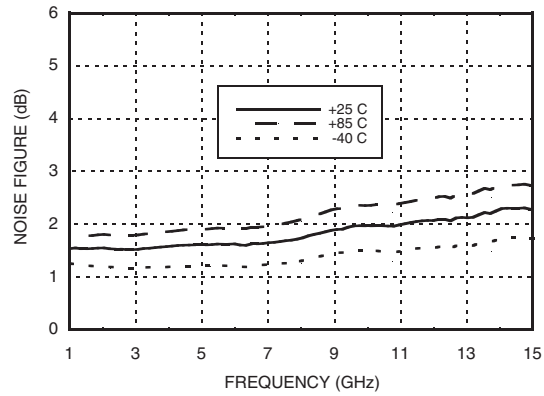

Output Return Loss vs. Temperature

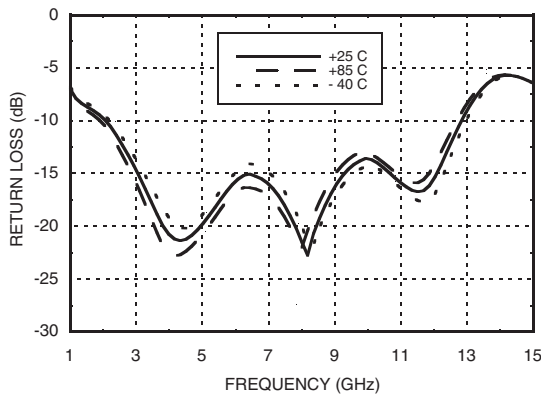

Input Return Loss vs. Temperature

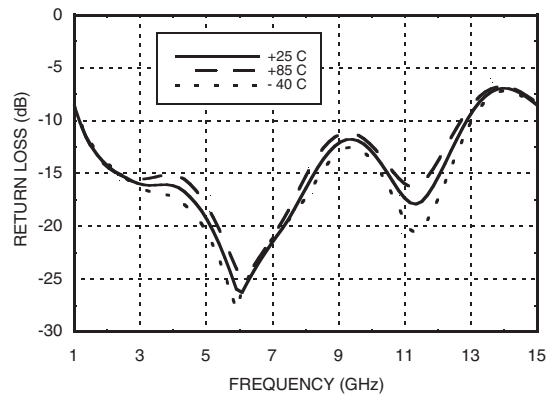

Output P1dB vs. Temperature

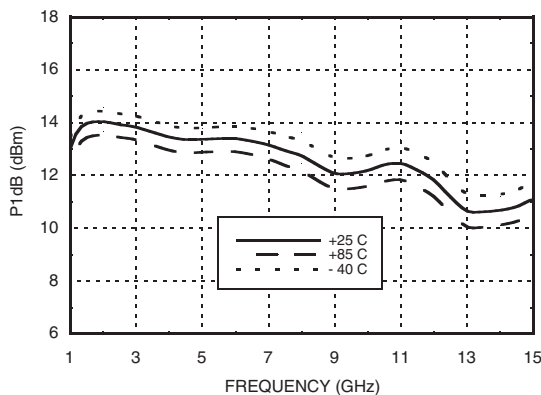

Output Psat vs. Temperature

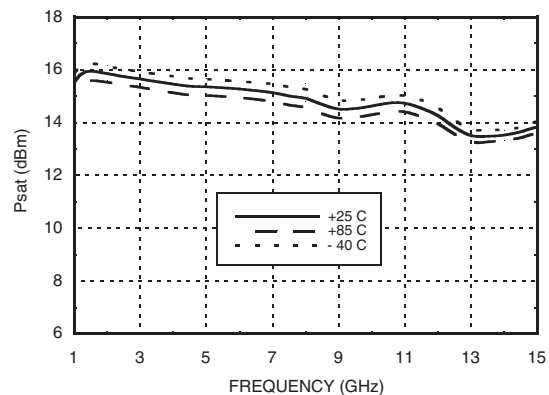



GaAs HEMT MMIC LOW NOISE AMPLIFIER, 2 - 12 GHz

8

LOW NOISE AMPLIFIERS - SMT

Output IP3 vs. Temperature

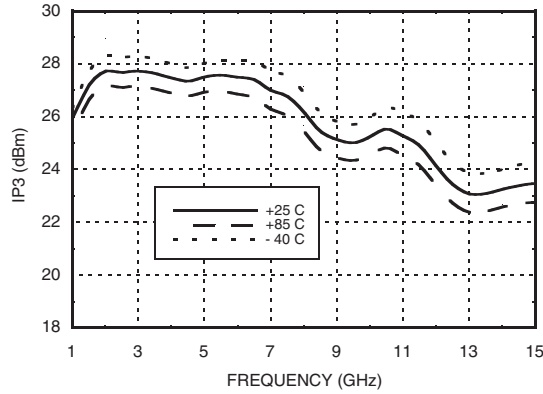

Power Compression @ 12 GHz

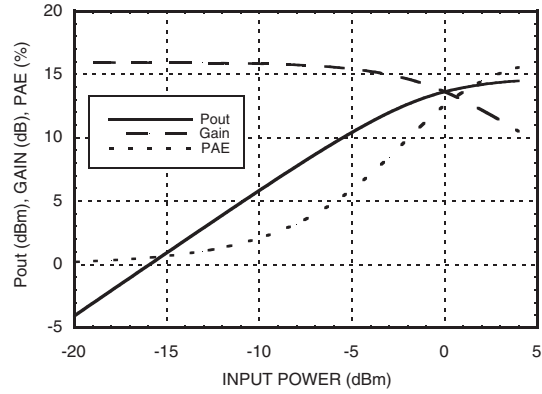

Reverse Isolation vs. Temperature

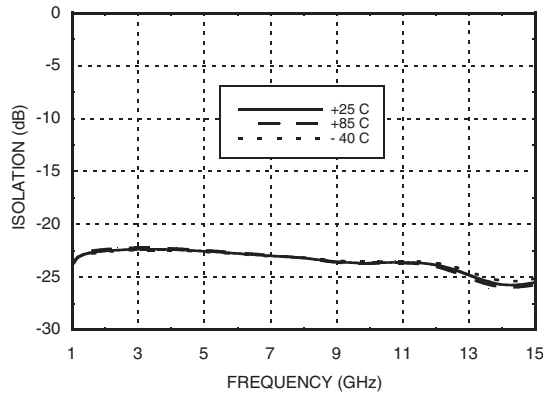

Gain, Noise Figure & Power vs. Supply Voltage @ 12 GHz

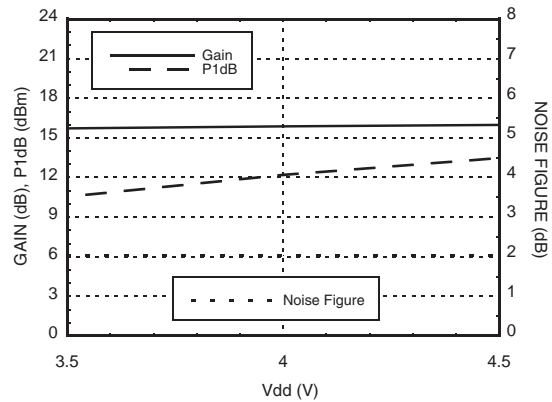

Absolute Maximum Ratings

Drain Bias Voltage	+5V
Drain Bias Current	60 mA
RF Input Power	5 dBm
Gate Bias Voltage	-1 to 0.3 V
Continuous P _{diss} (T = 85 °C) (derate 5.8 mW/°C above 85 °C)	0.55 W
Thermal Resistance (Channel to ground paddle)	172 °C/W
Channel Temperature	180 °C
Storage Temperature	-65 to +150 °C
Operating Temperature	-40 to +85 °C



ELECTROSTATIC SENSITIVE DEVICE
OBSERVE HANDLING PRECAUTIONS

Outline Drawing

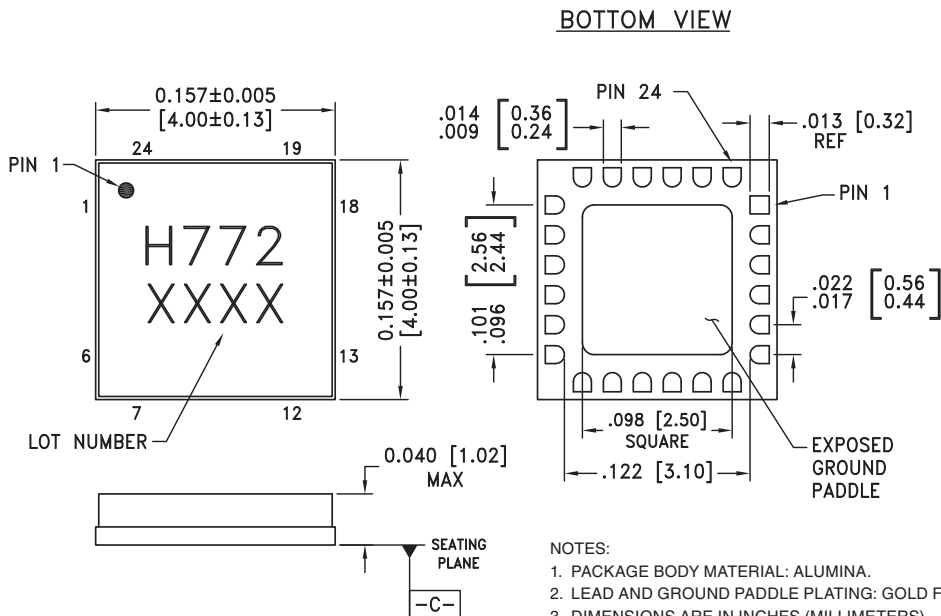

NOTES:

1. PACKAGE BODY MATERIAL: ALUMINA.
2. LEAD AND GROUND PADDLE PLATING: GOLD FLASH OVER NICKEL.
3. DIMENSIONS ARE IN INCHES (MILLIMETERS).
4. LEAD SPACING TOLERANCE IS NON-CUMULATIVE.
5. PACKAGE WARP SHALL NOT EXCEED 0.05MM DATUM -C-
6. ALL GROUND LEADS AND GROUND PADDLE MUST BE SOLDERED TO PCB RF GROUND.

Pin Descriptions

Pin Number	Function	Description	Interface Schematic
1, 2, 4 - 7, 12 - 15, 17 - 19, 24	GND	These pins and ground paddle must be connected to RF/DC ground.	
3	RFIN	This pin is AC coupled and matched to 50 Ohms.	
8	Vgg	Gate control for amplifier. Please follow "MMIC Amplifier Biasing Procedure" application note. See application circuit for required external components.	
9	Vdd	Power Supply Voltage for the amplifier. See application circuit for required external components.	
10, 11, 20 - 23	N/C	The pins are not connected internally; however, all data shown herein was measured with these pins connected to RF/DC ground externally.	
16	RFOUT	This pin is AC coupled and matched to 50 Ohms.	

Application Circuit

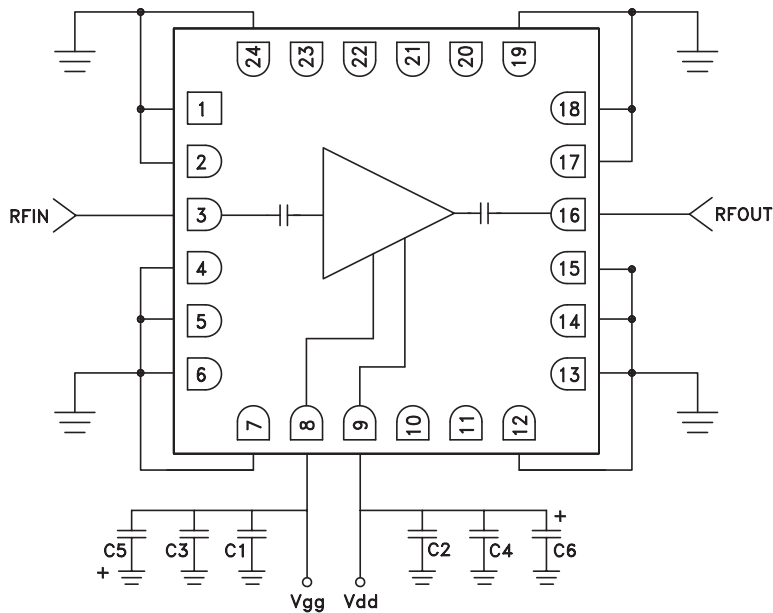

Evaluation PCB

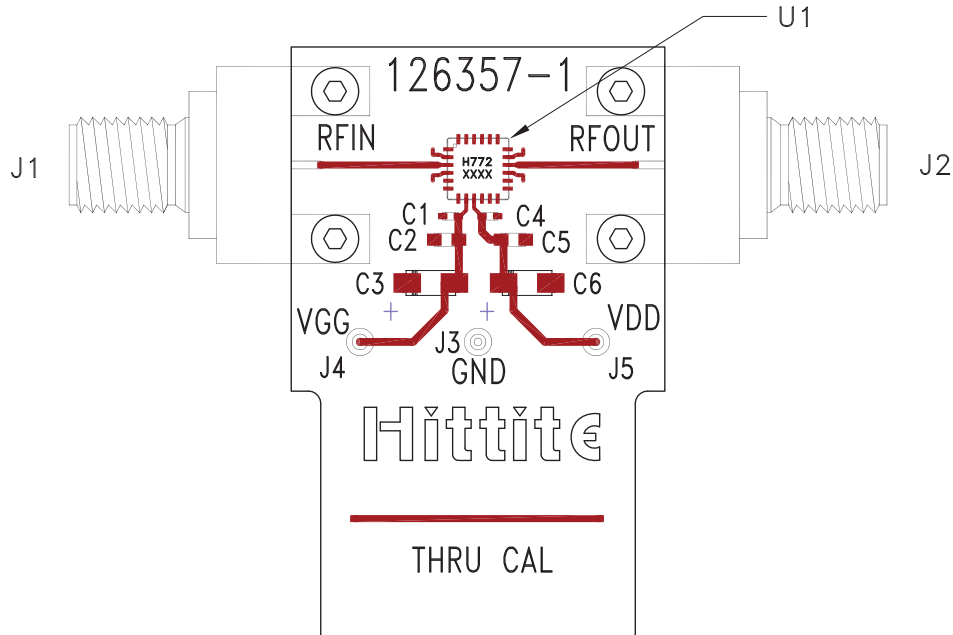

List of Material for Evaluation PCB 126359 [1]

Item	Description
J1, J2	PCB Mount 2.92mm K-Connector
J3 - J5	DC Pin
C1, C4	100 pF Capacitor, 0402 Pkg.
C2, C5	1000 pF Capacitor, 0603 Pkg.
C3, C6	4.7 μF Capacitor, Tantalum
U1	HMC772LC4 Amplifier
PCB [2]	126357 Evaluation PCB

[1] Reference this number when ordering complete evaluation PCB

[2] Circuit Board Material: Rogers 4350 or Arlon 25FR

The circuit board used in this application should use RF circuit design techniques. Signal lines should have 50 ohm impedance while the package ground leads and exposed paddle should be connected directly to the ground plane similar to that shown. A sufficient number of via holes should be used to connect the top and bottom ground planes. The evaluation board should be mounted to an appropriate heat sink. The evaluation circuit board shown is available from Hittite upon request.