



CYPRESS

CY7C135
CY7C1342

4K x 8 Dual-Port Static RAM and 4K x 8 Dual-Port SRAM with Semaphores

Features

- True Dual-Ported memory cells which allow simultaneous reads of the same memory location
- 4K x 8 organization
- 0.65-micron CMOS for optimum speed/power
- High-speed access: 15 ns
- Low operating power: $I_{CC} = 160 \text{ mA (max.)}$
- Fully asynchronous operation
- Automatic power-down
- Semaphores included on the 7C1342 to permit software handshaking between ports
- Available in 52-pin PLCC

Functional Description

The CY7C135 and CY7C1342 are high-speed CMOS 4K x 8 dual-port static RAMs. The CY7C1342 includes semaphores that provide a means to allocate portions of the dual-port RAM or any shared resource. Two ports are provided permitting independent, asynchronous access for reads and writes to any location in memory. Application areas include interprocessor/multiprocessor designs, communications status buffering, and dual-port video/graphics memory.

Each port has independent control pins: chip enable (\overline{CE}), read or write enable (R/\overline{W}), and output enable (\overline{OE}). The CY7C135 is suited for those systems that do not require on-chip arbitration or are intolerant of wait states. Therefore, the user must be aware that simultaneous access to a location is possible. Semaphores are offered on the CY7C1342 to assist in arbitrating between ports. The semaphore logic is comprised of eight shared latches. Only one side can control the latch (semaphore) at any time. Control of a semaphore indicates that a shared resource is in use. An automatic power-down feature is controlled independently on each port by a chip enable (\overline{CE}) pin or \overline{SEM} pin (CY7C1342 only).

The CY7C135 and CY7C1342 are available in 52-pin PLCC.

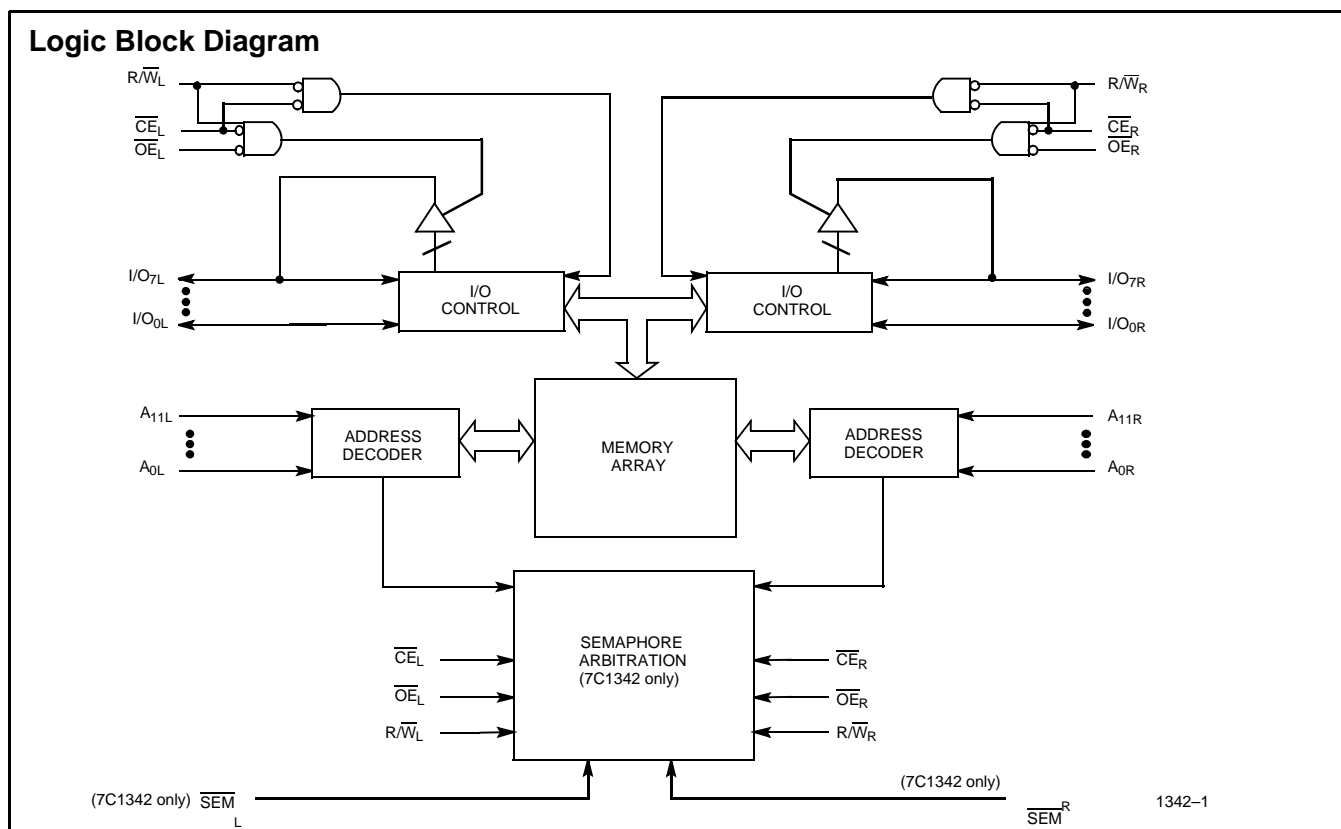

Selection Guide

| | | 7C135-15 7C1342-15 | 7C135-20 7C1342-20 | 7C135-25 7C1342-25 | 7C135-35 7C1342-35 | 7C135-55 7C1342-55 |
|---|------------|-----------------------|-----------------------|-----------------------|-----------------------|-----------------------|
| Maximum Access Time (ns) | | 15 | 20 | 25 | 35 | 55 |
| Maximum Operating Current (mA) | Commercial | 220 | 190 | 180 | 160 | 160 |
| Maximum Standby Current for I _{SB1} (mA) | Commercial | 60 | 50 | 40 | 30 | 30 |

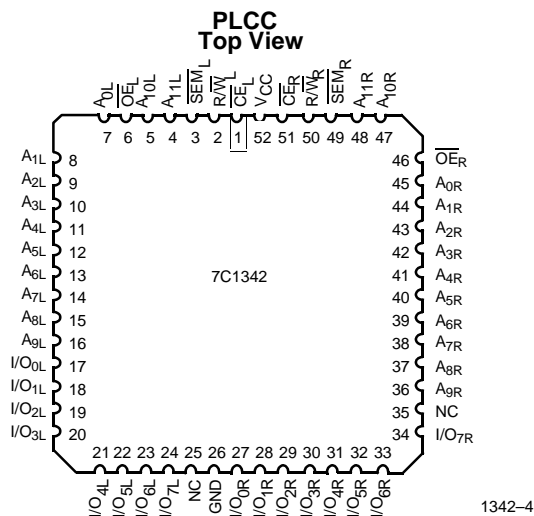
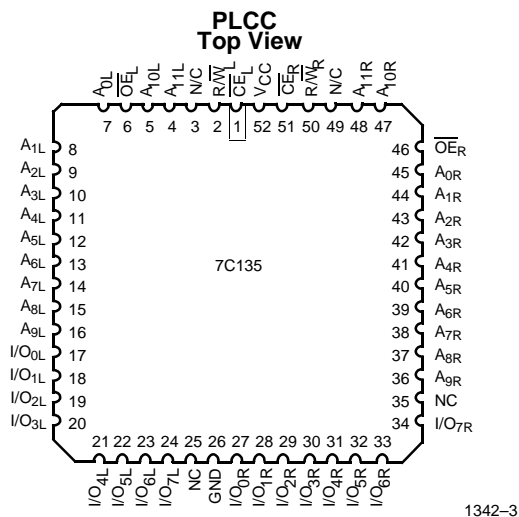
Pin Configurations

Pin Definitions

| Left Port | Right Port | Description |
|-------------------------------------|-------------------------------------|--|
| A _{0L-11L} | A _{0R-11R} | Address Lines |
| CE _L | CE _R | Chip Enable |
| OE _L | OE _R | Output Enable |
| R/W _L | R/W _R | Read/Write Enable |
| SEM _L (CY7C1342 only) | SEM _R (CY7C1342 only) | Semaphore Enable. When asserted LOW, allows access to eight semaphores. The three least significant bits of the address lines will determine which semaphore to write or read. The I/O ₀ pin is used when writing to a semaphore. Semaphores are requested by writing a 0 into the respective location. |



Maximum Ratings^[1]

Storage Temperature-65°C to+150°C
 Ambient Temperature with
 Power Applied.....-55°C to+125°C
 Supply Voltage to Ground Potential
 (Pin 48 to Pin 24)-0.5V to+7.0V
 DC Voltage Applied to Outputs
 in High Z State-0.5V to+7.0V
 DC Input Voltage^[2].....-3.0V to +7.0V

Static Discharge Voltage..... > 2001V
 (per MIL-STD-883, Method 3015)
 Latch-Up Current..... > 200 mA

Operating Range

| Range | Ambient Temperature | V _{CC} |
|------------|---------------------|-----------------|
| Commercial | 0°C to +70°C | 5V ± 10% |
| Industrial | -40°C to +85°C | 5V ± 10% |

Electrical Characteristics Over the Operating Range^[4]

| Parameter | Description | Test Conditions | 7C135-15 7C1342-15 | | 7C135-20 7C1342-20 | | 7C135-25 7C1342-25 | | Unit |
|------------------|---|--|-----------------------|------|-----------------------|------|-----------------------|------|------|
| | | | Min. | Max. | Min. | Max. | Min. | Max. | |
| V _{OH} | Output HIGH Voltage | V _{CC} = Min., I _{OH} = -4.0 mA | 2.4 | | 2.4 | | 2.4 | | V |
| V _{OL} | Output LOW Voltage | V _{CC} = Min., I _{OL} = 4.0 mA | | 0.4 | | 0.4 | | 0.4 | V |
| V _{IH} | Input HIGH Voltage | | 2.2 | | 2.2 | | 2.2 | | V |
| V _{IL} | Input LOW Voltage | | | 0.8 | | 0.8 | | 0.8 | V |
| I _{IX} | Input Load Current | GND ≤ V _I ≤ V _{CC} | -10 | +10 | -10 | +10 | -10 | +10 | µA |
| I _{OZ} | Output Leakage Current | Outputs Disabled, GND ≤ V _O ≤ V _{CC} | -10 | +10 | -10 | +10 | -10 | +10 | µA |
| I _{CC} | Operating Current | V _{CC} = Max., I _{OUT} = 0 mA | Com'l | 220 | | 190 | | 180 | mA |
| | | | Ind. | | | | | 190 | |
| I _{SB1} | Standby Current (Both Ports TTL Levels) | CE _L and CE _R ≥ V _{IH} , f = f _{MAX} ^[5] | Com'l | 60 | | 50 | | 40 | mA |
| | | | Ind. | | | | | 50 | |
| I _{SB2} | Standby Current (One Port TTL Level) | CE _L and CE _R ≥ V _{IH} , f = f _{MAX} ^[5] | Com'l | 130 | | 120 | | 110 | mA |
| | | | Ind. | | | | | 120 | |
| I _{SB3} | Standby Current (Both Ports CMOS Levels) | Both Ports CE and CE _R ≥ V _{CC} - 0.2V, V _{IN} ≥ V _{CC} - 0.2V or V _{IN} ≤ 0.2V, f = 0 ^[5] | Com'l | 15 | | 15 | | 15 | mA |
| | | | Ind. | | | | | 30 | |
| I _{SB4} | Standby Current (One Port CMOS Level) | One Port CE _L or CE _R ≥ V _{CC} - 0.2V, V _{IN} ≥ V _{CC} - 0.2V or V _{IN} ≤ 0.2V, Active Port Outputs, f = f _{MAX} ^[5] | Com'l | 125 | | 115 | | 100 | mA |
| | | | Ind. | | | | | 115 | |

Notes:

1. The Voltage on any input or I/O pin cannot exceed the power pin during power-up.
2. Pulse width < 20 ns.
3. T_A is the "instant on" case temperature.
4. See the last page of this specification for Group A subgroup testing information.
5. f_{MAX} = 1/t_{RC} = All inputs cycling at f = 1/t_{RC} (except output enable). f = 0 means no address or control lines change. This applies only to inputs at CMOS level standby I_{SB3}.

Electrical Characteristics Over the Operating Range^[4](continued)

| Parameter | Description | Test Conditions | 7C135-35 7C1342-35 | | 7C135-55 7C1342-55 | | Unit |
|------------------|---|--|-----------------------|------|-----------------------|------|------|
| | | | Min. | Max. | Min. | Max. | |
| V _{OH} | Output HIGH Voltage | V _{CC} = Min., I _{OH} = -4.0 mA | 2.4 | | 2.4 | | V |
| V _{OL} | Output LOW Voltage | V _{CC} = Min., I _{OL} = 4.0 mA | | 0.4 | | 0.4 | V |
| V _{IH} | | | 2.2 | | 2.2 | | V |
| V _{IL} | Input LOW Voltage | | | 0.8 | | 0.8 | V |
| I _{IX} | Input Load Current | GND ≤ V _I ≤ V _{CC} | -10 | +10 | -10 | +10 | μA |
| I _{OZ} | Output Leakage Current | Outputs Disabled, GND ≤ V _O ≤ V _{CC} | -10 | +10 | -10 | +10 | μA |
| I _{CC} | Operating Current | V _{CC} = Max., I _{OUT} = 0 mA | Com'l | 160 | | 160 | mA |
| | | V _{CC} = Max., I _{OUT} = 0 mA | Ind. | 180 | | 180 | |
| I _{SB1} | Standby Current (Both Ports TTL Levels) | CE _L and CE _R ≥ V _{IH} , f = f _{MAX} ^[5] | Com'l | 30 | | 30 | mA |
| | | | Ind. | 40 | | 40 | |
| I _{SB2} | Standby Current (One Port TTL Level) | CE _L and CE _R ≥ V _{IH} , f = f _{MAX} ^[5] | Com'l | 100 | | 100 | mA |
| | | | Ind. | 110 | | 110 | |
| I _{SB3} | Standby Current (Both Ports CMOS Levels) | Both Ports CE and CE _R ≥ V _{CC} - 0.2V, V _{IN} ≥ V _{CC} - 0.2V or V _{IN} ≤ 0.2V, f = 0 ^[5] | Com'l | 15 | | 15 | mA |
| | | | Ind. | 30 | | 30 | |
| I _{SB4} | Standby Current (One Port CMOS Level) | One Port CE _L or CE _R ≥ V _{CC} - 0.2V, V _{IN} ≥ V _{CC} - 0.2V or V _{IN} ≤ 0.2V, Active Port Outputs, f = f _{MAX} ^[5] | Com'l | 90 | | 90 | mA |
| | | | Ind. | 100 | | 100 | |

Capacitance^[6]

| Parameter | Description | Test Conditions | Max. | Unit |
|------------------|--------------------|---|------|------|
| C _{IN} | Input Capacitance | T _A = 25°C, f = 1 MHz, V _{CC} = 5.0V | 10 | pF |
| C _{OUT} | Output Capacitance | | 10 | pF |

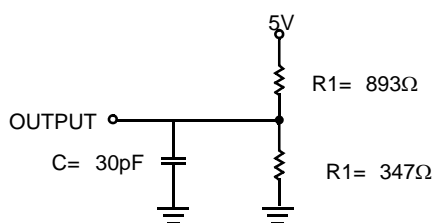
AC Test Loads and Waveforms

(a) Normal Load (Load 1)

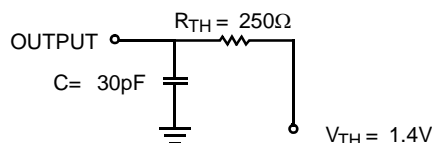
1342-5

(b) Thévenin Equivalent (Load 1)

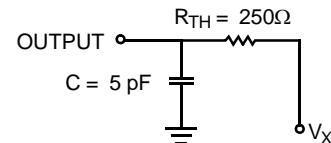
1342-6

(c) Three-State Delay (Load 3)

1342-7

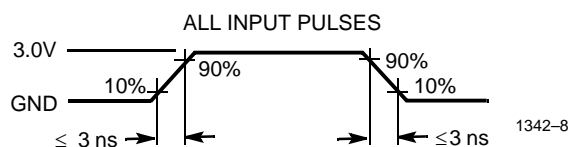

1342-8

Note:

- Tested initially and after any design or process changes that may affect these parameters.

Switching Characteristics Over the Operating Range^[7, 8]

| Parameter | Description | 7C135–15 7C1342–15 | | 7C135–20 7C1342–20 | | 7C135–25 7C1342–25 | | 7C135–35 7C1342–35 | | 7C135–55 7C1342–55 | | Unit |
|--|-------------------------------------|-----------------------|------|-----------------------|------|-----------------------|------|-----------------------|------|-----------------------|------|------|
| | | Min. | Max. | Min. | Max. | Min. | Max. | Min. | Max. | Min. | Max. | |
| READ CYCLE | | | | | | | | | | | | |
| t _{RC} | Read Cycle Time | 15 | | 20 | | 25 | | 35 | | 55 | | ns |
| t _{AA} | Address to Data Valid | | 15 | | 20 | | 25 | | 35 | | 55 | ns |
| t _{OHA} | Output Hold From Address Change | 3 | | 3 | | 3 | | 3 | | 3 | | ns |
| t _{ACE} | CE LOW to Data Valid | | 15 | | 20 | | 25 | | 35 | | 55 | ns |
| t _{DOE} | OE LOW to Data Valid | | 10 | | 13 | | 15 | | 20 | | 25 | ns |
| t _{LZOE} ^[9,10,11] | OE Low to Low Z | 3 | | 3 | | 3 | | 3 | | 3 | | ns |
| t _{HZOE} ^[9,10,11] | OE HIGH to High Z | | 10 | | 13 | | 15 | | 20 | | 25 | ns |
| t _{LZCE} ^[9,10,11] | CE LOW to Low Z | 3 | | 3 | | 3 | | 3 | | 3 | | ns |
| t _{HZCE} ^[9,10,11] | CE HIGH to High Z | | 10 | | 13 | | 15 | | 20 | | 25 | ns |
| t _{PU} ^[11] | CE LOW to Power Up | 0 | | 0 | | 0 | | 0 | | 0 | | ns |
| t _{PD} ^[11] | CE HIGH to Power Down | | 15 | | 20 | | 25 | | 35 | | 55 | ns |
| WRITE CYCLE | | | | | | | | | | | | |
| t _{WC} | Write Cycle Time | 15 | | 20 | | 25 | | 35 | | 55 | | ns |
| t _{SCE} | CE LOW to Write End | 12 | | 15 | | 20 | | 30 | | 50 | | ns |
| t _{AW} | Address Set-Up to Write End | 12 | | 15 | | 20 | | 30 | | 50 | | ns |
| t _{HA} | Address Hold from Write End | 2 | | 2 | | 2 | | 2 | | 2 | | ns |
| t _{SA} | Address Set-Up to Write Start | 0 | | 0 | | 0 | | 0 | | 0 | | ns |
| t _{PWE} | Write Pulse Width | 12 | | 15 | | 20 | | 25 | | 50 | | ns |
| t _{SD} | Data Set-Up to Write End | 10 | | 13 | | 15 | | 15 | | 25 | | ns |
| t _{HD} | Data Hold from Write End | 0 | | 0 | | 0 | | 0 | | 0 | | ns |
| t _{HZWE} ^[10,11] | R/W LOW to High Z | | 10 | | 13 | | 15 | | 20 | | 25 | ns |
| t _{LZWE} ^[10,11] | R/W HIGH to Low Z | 3 | | 3 | | 3 | | 3 | | 3 | | ns |
| t _{WDD} ^[12] | Write Pulse to Data Delay | | 30 | | 40 | | 50 | | 60 | | 70 | ns |
| t _{DDD} ^[12] | Write Data Valid to Read Data Valid | | 25 | | 30 | | 30 | | 35 | | 40 | ns |
| SEMAPHORE TIMING^[13] | | | | | | | | | | | | |
| t _{SOP} | SEM Flag Update Pulse (OE or SEM) | 10 | | 10 | | 10 | | 15 | | 15 | | ns |
| t _{SWRD} | SEM Flag Write to Read Time | 5 | | 5 | | 5 | | 5 | | 5 | | ns |
| t _{SPS} | SEM Flag Contention Window | 5 | | 5 | | 5 | | 5 | | 5 | | ns |

Notes:

7. See the last page of this specification for Group A subgroup testing information.
8. Test conditions assume signal transition time of 3 ns or less, timing reference levels of 1.5V, input pulse levels of 0 to 3.0V, and output loading of the specified I_{OL}/I_{OH} and 30-pF load capacitance.
9. At any given temperature and voltage condition for any given device, t_{HZCE} is less than t_{LZCE} and t_{HZOE} is less than t_{LZOE}.
10. Test conditions used are Load 3.
11. This parameter is guaranteed but not tested.
12. For information on port-to-port delay through RAM cells from writing port to reading port, refer to Read Timing with Port-to-Port Delay waveform.
13. Semaphore timing applies only to CY7C1342.

Switching Waveforms

Read Cycle No. 1^[14,15]

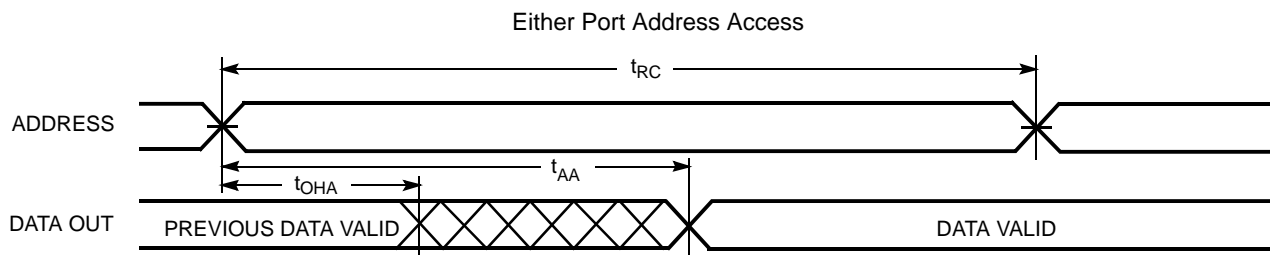

1342-9

Read Cycle No. 2^[14,16]

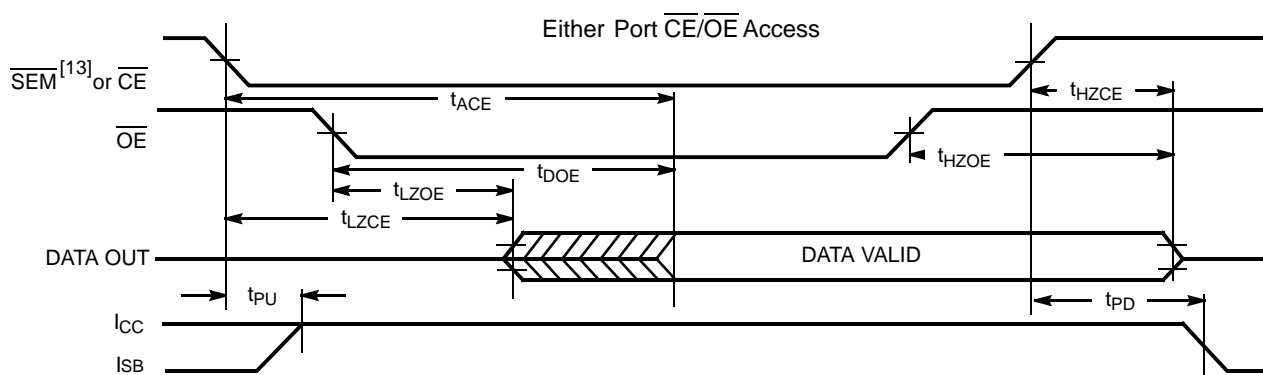

1342-10

Read Timing with Port-to-Port^[17]

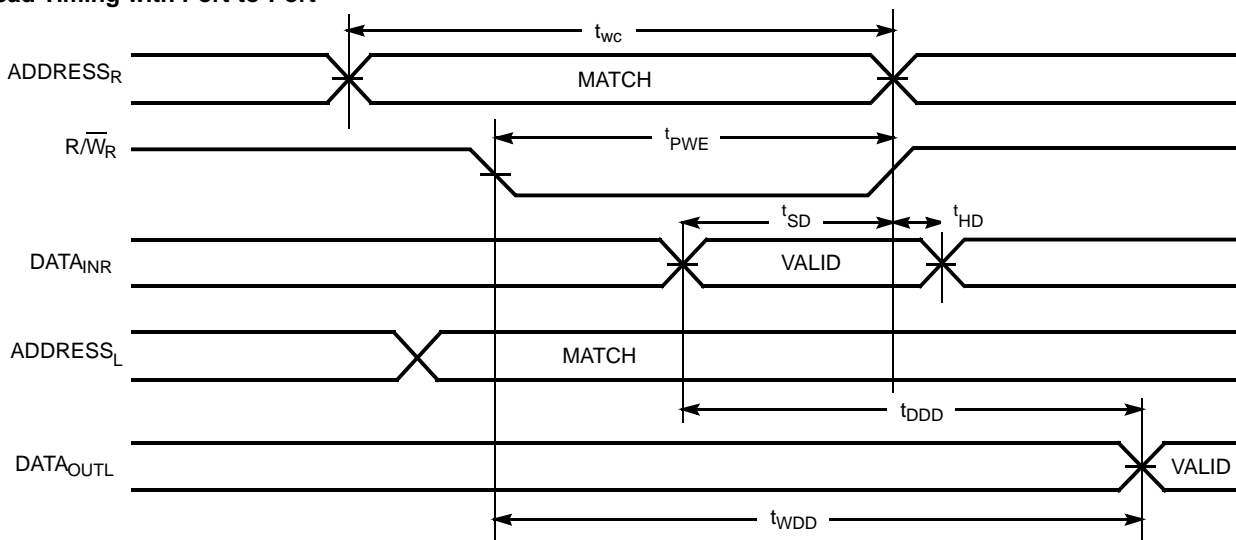

1342-11

Notes:

14. R/\overline{W} is HIGH for read cycle.
15. Device is continuously selected, $\overline{CE} = V_{IL}$ and $\overline{OE} = V_{IL}$.
16. Address valid prior to or coincident with \overline{CE} transition LOW.
17. $CE_L = CE_R = \text{LOW}$; $R/\overline{W}_L = \text{HIGH}$

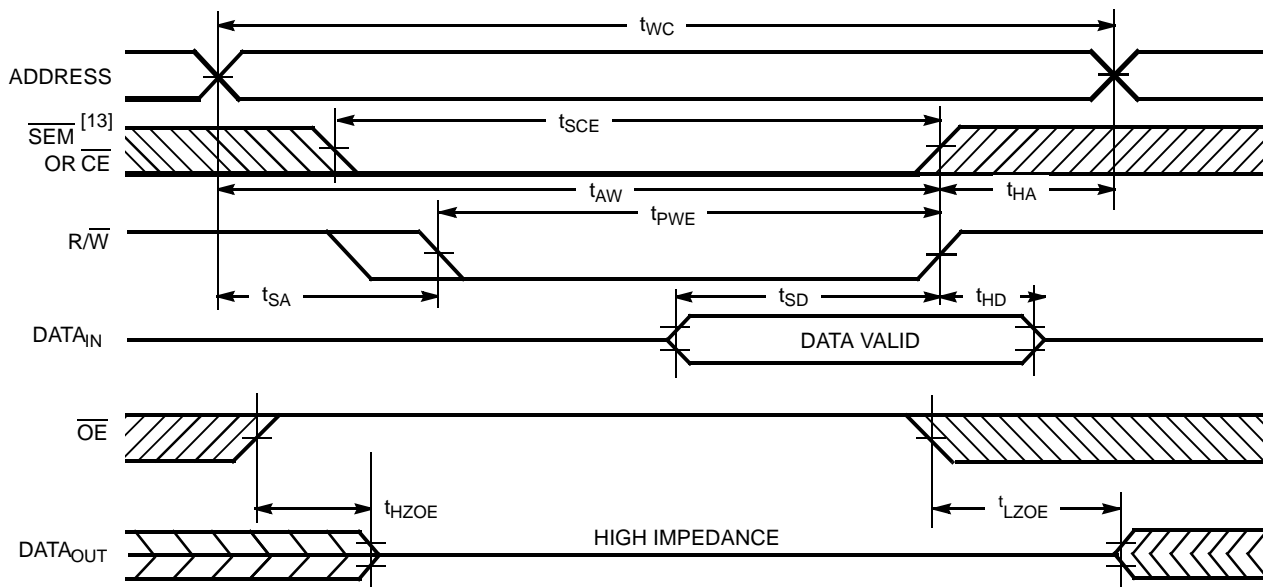
Switching Waveforms (continued)
Write Cycle No. 1: \overline{OE} Three-States Data I/Os (Either Port)^[18,19,20]

1342-12

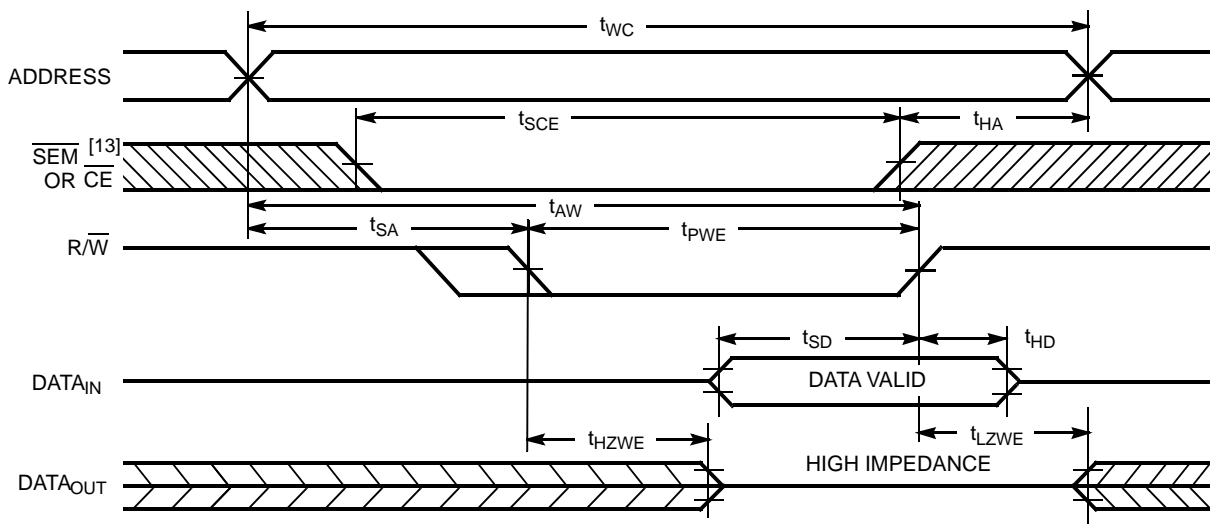
Write Cycle No. 2: $\overline{R/W}$ Three-States Data I/Os (Either Port)^[19, 21]

1342-13

Notes:

18. The internal write time of the memory is defined by the overlap of \overline{CE} or \overline{SEM} LOW and $\overline{R/W}$ LOW. Both signals must be LOW to initiate a write and either signal can terminate a write by going HIGH. The data input set-up and hold timing should be referenced to the rising edge of the signal that terminates the write.
19. $\overline{R/W}$ must be HIGH during all address transactions.
20. If \overline{OE} is LOW during a $\overline{R/W}$ controlled write cycle, the write pulse width must be the larger of t_{PWE} or $(t_{HZWE} + t_{SD})$ to allow the I/O drivers to turn off and data to be placed on the bus for the required t_{SD} . If \overline{OE} is HIGH during a $\overline{R/W}$ controlled write cycle (as in this example), this requirement does not apply and the write pulse can be as short as the specified t_{PWE} .
21. Data I/O pins enter high-impedance when \overline{OE} is held LOW during write.

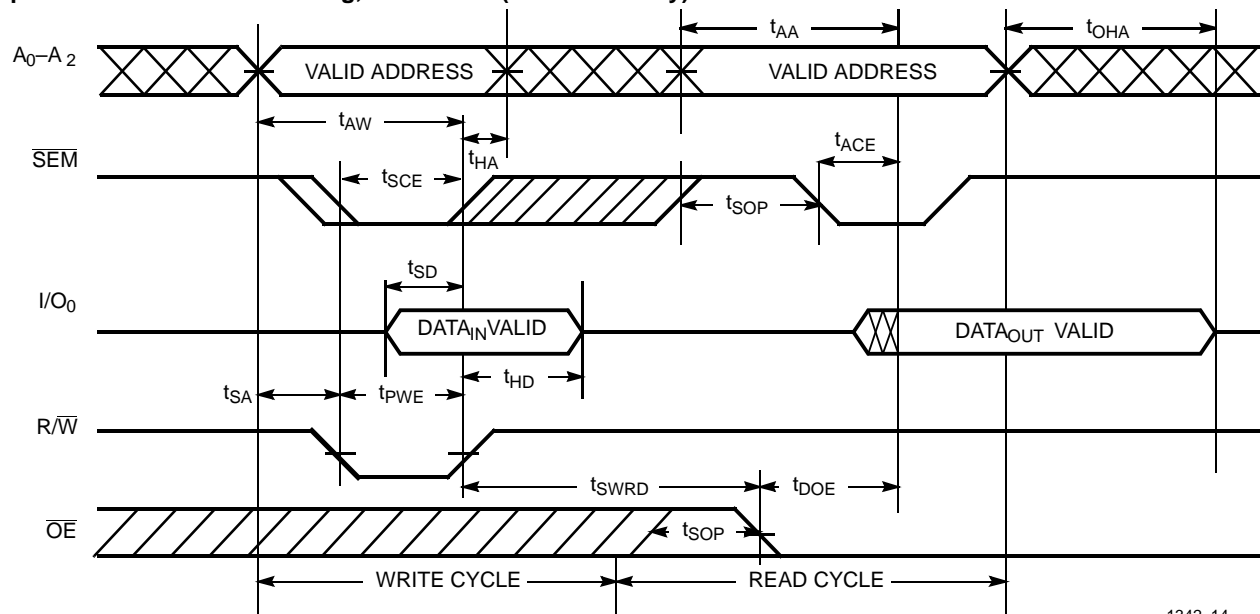
Switching Waveforms (continued)
Semaphore Read After Write Timing, Either Side (CY7C1342 only)^[22]

1342-14

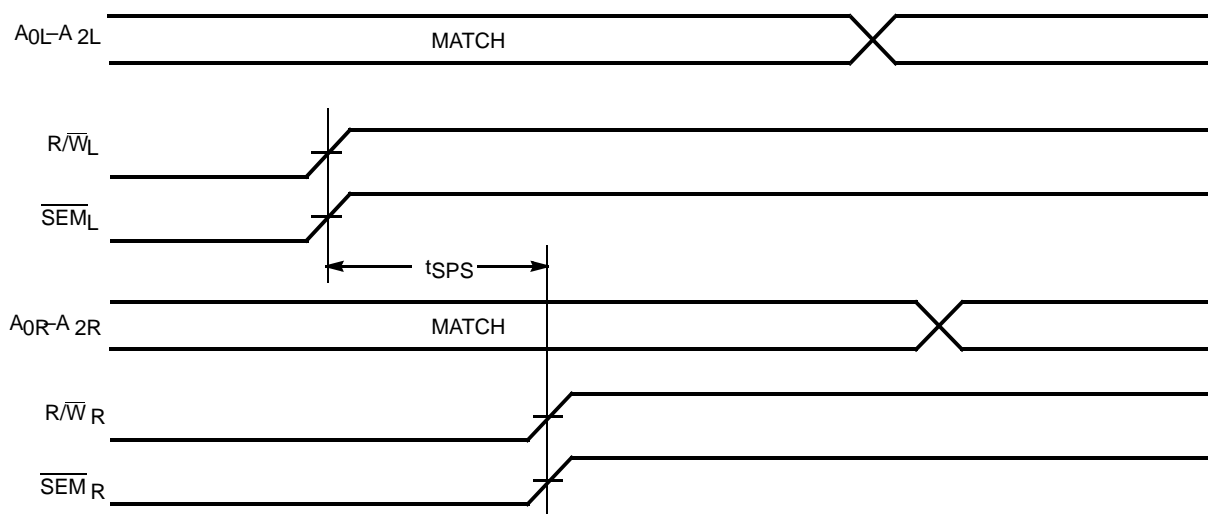
Timing Diagram of Semaphore Contention (CY7C1342 only)^[23,24,25]

1342-15

Notes:

22. CE = HIGH for the duration of the above timing (both write and read cycle).
23. I/O_{0R} = I/O_{0L} = LOW (request semaphore); CE_R = CE_L = HIGH.
24. Semaphores are reset (available to both ports) at cycle start.
25. If t_{SPS} is violated, it is guaranteed that only one side will gain access to the semaphore.

Architecture

The CY7C135 consists of an array of 4K words of 8 bits each of dual-port RAM cells, I/O and address lines, and control signals (\overline{CE} , \overline{OE} , R/W). Two semaphore control pins exist for the CY7C1342 ($\overline{SEM}_{L/R}$).

Functional Description

Write Operation

Data must be set up for a duration of t_{SD} before the rising edge of R/W in order to guarantee a valid write. Since there is no on-chip arbitration, the user must be sure that a specific location will not be accessed simultaneously by both ports or erroneous data could result. A write operation is controlled by either the \overline{OE} pin (see Write Cycle No. 1 timing diagram) or the R/W pin (see Write Cycle No. 2 timing diagram). Data can be written t_{HZOE} after the \overline{OE} is deasserted or t_{HZWE} after the falling edge of R/W. Required inputs for write operations are summarized in Table 1.

If a location is being written to by one port and the opposite port attempts to read the same location, a port-to-port flowthrough delay is met before the data is valid on the output. Data will be valid on the port wishing to read the location t_{DD} after the data is presented on the writing port.

Read Operation

When reading the device, the user must assert both the \overline{OE} and \overline{CE} pins. Data will be available t_{ACE} after \overline{CE} or t_{DOE} after \overline{OE} are asserted. If the user of the CY7C1342 wishes to access a semaphore, the \overline{SEM} pin must be asserted instead of the \overline{CE} pin. Required inputs for read operations are summarized in Table 1.

Semaphore Operation

The CY7C1342 provides eight semaphore latches which are separate from the dual port memory locations. Semaphores are used to reserve resources which are shared between the two ports. The state of the semaphore indicates that a resource is in use. For example, if the left port wants to request a given resource, it sets a latch by writing a zero to a semaphore location. The left port then verifies its success in setting the latch by reading it. After writing to the semaphore, \overline{SEM} or \overline{OE} must be deasserted for t_{SOP} before attempting to read the semaphore. The semaphore value will be available $t_{SWRD} + t_{DOE}$ after the rising edge of the semaphore write. If the left port was successful (reads a zero), it assumes control over the shared resource, otherwise (reads a one) it assumes the right port has control and continues to poll the semaphore. When the right side has relinquished control of the semaphore (by writing a one), the left side will succeed in gaining control of the semaphore. If the left side no longer requires the semaphore, a one is written to cancel its request.

Semaphores are accessed by asserting \overline{SEM} LOW. The \overline{SEM} pin functions as a chip enable for the semaphore latches. \overline{CE} must remain HIGH during \overline{SEM} LOW. A_{0-2} represents the semaphore address. \overline{OE} and R/W are used in the same manner as a normal memory access. When writing or reading a semaphore, the other address pins have no effect.

When writing to the semaphore, only I/O₀ is used. If a 0 is written to the left port of an unused semaphore, a one will appear at the same semaphore address on the right port. That semaphore can now only be modified by the side showing a

zero (the left port in this case). If the left port now relinquishes control by writing a one to the semaphore, the semaphore will be set to one for both sides. However, if the right port had requested the semaphore (written a zero) while the left port had control, the right port would immediately own the semaphore. Table 2 shows sample semaphore operations.

When reading a semaphore, all eight data lines output the semaphore value. The read value is latched in an output register to prevent the semaphore from changing state during a write from the other port. If both ports request a semaphore control by writing a 0 to a semaphore within t_{SPS} of each other, it is guaranteed that only one side will gain access to the semaphore.

Initialization of the semaphore is not automatic and must be reset during initialization program at power-up. All semaphores on both sides should have a one written into them at initialization from both sides to assure that they will be free when needed.

Table 1. Non-Contending Read/Write

| Inputs | | | | Outputs | Operation |
|-----------------|-----|-----------------|------------------|-------------------------------------|--------------------|
| \overline{CE} | R/W | \overline{OE} | \overline{SEM} | I/O ₀ – I/O ₇ | |
| H | X | X | H | High Z | Power-Down |
| H | H | L | L | Data Out | Read Semaphore |
| X | X | H | X | High Z | I/O Lines Disabled |
| H | L | X | L | Data In | Write to Semaphore |
| L | H | L | H | Data Out | Read |
| L | L | X | H | Data In | Write |
| L | X | X | L | | Illegal Condition |

Table 2. Semaphore Operation Example

| Function | I/O ₀₋₇ Left | I/O ₀₋₇ Right | Status |
|----------------------------------|-------------------------|--------------------------|---|
| No Action | 1 | 1 | Semaphore free |
| Left port writes semaphore | 0 | 1 | Left port obtains semaphore |
| Right port writes 0 to semaphore | 0 | 1 | Right side is denied access |
| Left port writes 1 to semaphore | 1 | 0 | Right port is granted access to Semaphore |
| Left port writes 0 to semaphore | 1 | 0 | No change. Left port is denied access |
| Right port writes 1 to semaphore | 0 | 1 | Left port obtains semaphore |
| Left port writes 1 to semaphore | 1 | 1 | No port accessing semaphore address |
| Right port writes 0 to semaphore | 1 | 0 | Right port obtains semaphore |
| Right port writes 1 to semaphore | 1 | 1 | No port accessing semaphore |
| Left port writes 0 to semaphore | 0 | 1 | Left port obtains semaphore |
| Left port writes 1 to semaphore | 1 | 1 | No port accessing semaphore |

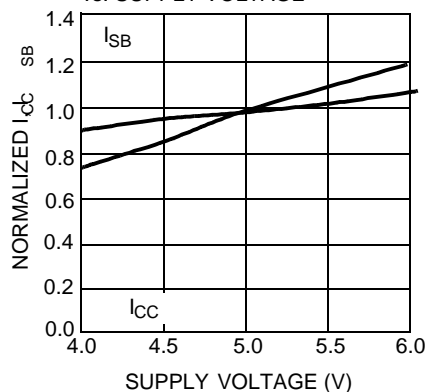
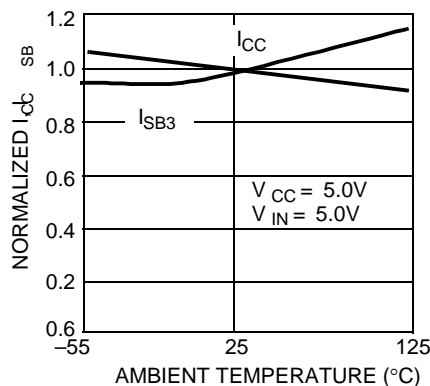
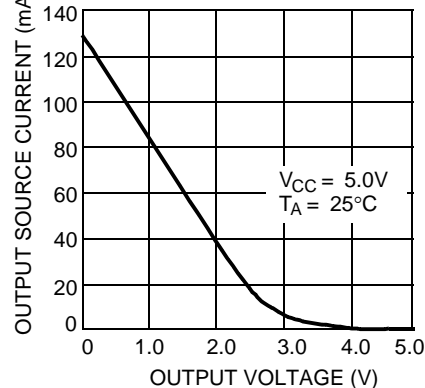
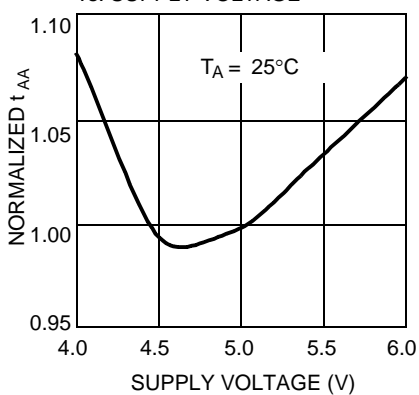
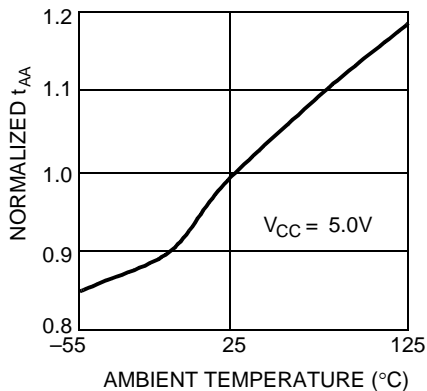
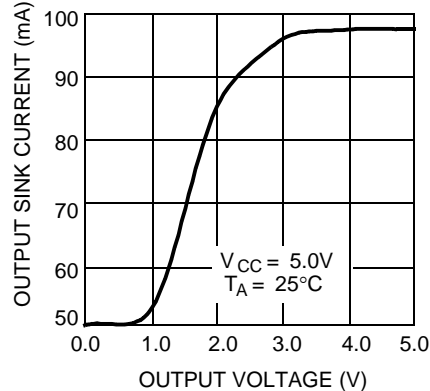
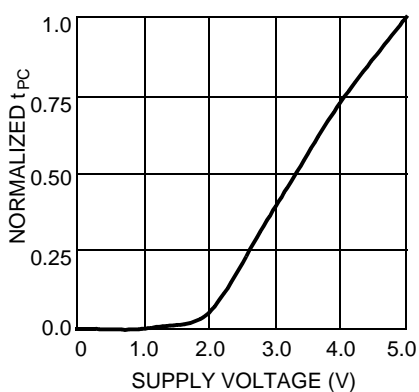
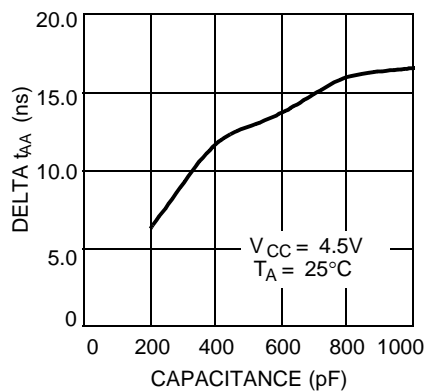
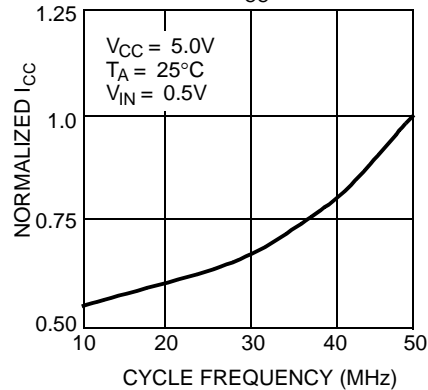
Typical DC and AC Characteristics
NORMALIZED SUPPLY CURRENT vs. SUPPLY VOLTAGE

NORMALIZED SUPPLY CURRENT vs. AMBIENT TEMPERATURE

OUTPUT SOURCE CURRENT vs. OUTPUT VOLTAGE

NORMALIZED ACCESS TIME vs. SUPPLY VOLTAGE

NORMALIZED ACCESS TIME vs. AMBIENT TEMPERATURE

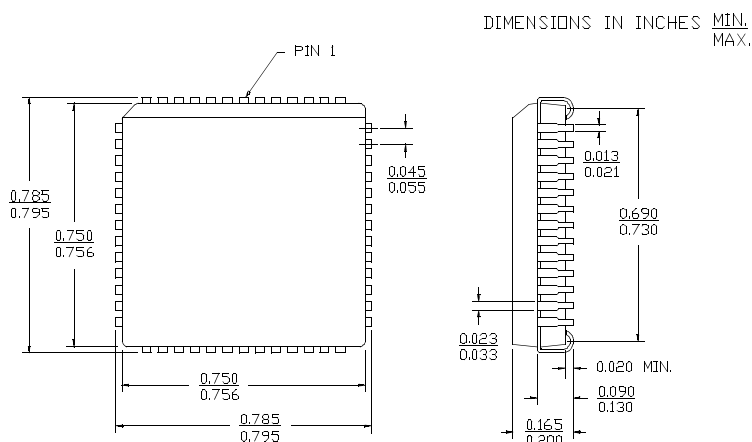
OUTPUT SINK CURRENT vs. OUTPUT VOLTAGE

TYPICAL POWER-ON CURRENT vs. SUPPLY VOLTAGE

TYPICAL ACCESS TIME CHANGE vs. OUTPUT LOADING

NORMALIZED I_{CC} vs. CYCLE TIME

Ordering Information
4K x8 Dual-Port SRAM

| Speed (ns) | Ordering Code | Package Name | Package Type | Operating Range |
|------------|---------------|--------------|-------------------------------------|-----------------|
| 15 | CY7C135-15JC | J69 | 52-Lead Plastic Leaded Chip Carrier | Commercial |
| 20 | CY7C135-20JC | J69 | 52-Lead Plastic Leaded Chip Carrier | Commercial |
| 25 | CY7C135-25JC | J69 | 52-Lead Plastic Leaded Chip Carrier | Commercial |
| | CY7C135-25JI | J69 | 52-Lead Plastic Leaded Chip Carrier | Industrial |
| 35 | CY7C135-35JC | J69 | 52-Lead Plastic Leaded Chip Carrier | Commercial |
| | CY7C135-35JI | J69 | 52-Lead Plastic Leaded Chip Carrier | Industrial |
| 55 | CY7C135-55JC | J69 | 52-Lead Plastic Leaded Chip Carrier | Commercial |
| | CY7C135-55JI | J69 | 52-Lead Plastic Leaded Chip Carrier | Industrial |

4K x8 Dual-Port SRAM with Semaphores

| Speed (ns) | Ordering Code | Package Type | Package Type | Operating Range |
|------------|---------------|--------------|-------------------------------------|-----------------|
| 15 | CY7C1342-15JC | J69 | 52-Lead Plastic Leaded Chip Carrier | Commercial |
| 20 | CY7C1342-20JC | J69 | 52-Lead Plastic Leaded Chip Carrier | Commercial |
| 25 | CY7C1342-25JC | J69 | 52-Lead Plastic Leaded Chip Carrier | Commercial |
| | CY7C1342-25JI | J69 | 52-Lead Plastic Leaded Chip Carrier | Industrial |
| 35 | CY7C1342-35JC | J69 | 52-Lead Plastic Leaded Chip Carrier | Commercial |
| | CY7C1342-35JI | J69 | 52-Lead Plastic Leaded Chip Carrier | Industrial |
| 55 | CY7C1342-55JC | J69 | 52-Lead Plastic Leaded Chip Carrier | Commercial |
| | CY7C1342-55JI | J69 | 52-Lead Plastic Leaded Chip Carrier | Industrial |

Package Diagrams
52-Lead Plastic Leaded Chip Carrier J69

51-85004-*A

Document History Page

Document Title: CY7C135/CY7C1342 4K x 8 Dual Port Static RAM and 4K x 8 Dual Port Static RAM w/Semaphores
Document Number: 38-06038

| REV. | ECN NO. | Issue Date | Orig. of Change | Description of Change |
|------|---------|------------|-----------------|--|
| ** | 110181 | 10/21/01 | SZV | Change from Spec number: 38-00541 to 38-06038 |
| *A | 122288 | 12/27/02 | RBI | Power up requirements added to Maximum Ratings Information |
| *B | 236763 | SEE ECN | YDT | Removed cross information from features section |