

FEATURES

Isolated RS-485/RS-422 transceiver, configurable as half or full duplex

isoPower[®] integrated isolated dc-to-dc converter

± 15 kV ESD protection on RS-485 input/output pins

Complies with ANSI/TIA/EIA-485-A-98 and ISO 8482:1987(E)

ADM2582E data rate: 16 Mbps

ADM2587E data rate: 500 kbps

5 V or 3.3 V operation

Connect up to 256 nodes on one bus

Open- and short-circuit, fail-safe receiver inputs

High common-mode transient immunity: >25 kV/ μ s

Thermal shutdown protection

Safety and regulatory approvals (pending)

UL recognition: 2500 V rms for 1 minute per UL 1577

VDE Certificates of Conformity

DIN V VDE V 0884-10 (VDE V 0884-10):2006-12

$V_{IORM} = 560$ V peak

Operating temperature range: -40°C to $+85^{\circ}\text{C}$

Highly integrated, 20-lead, wide-body SOIC package

APPLICATIONS

Isolated RS-485/RS-422 interfaces

Industrial field networks

Multipoint data transmission systems

GENERAL DESCRIPTION

The ADM2582E/ADM2587E are fully integrated signal and power isolated data transceivers with ± 15 kV ESD protection and are suitable for high speed communication on multipoint transmission lines. The ADM2582E/ADM2587E include an integrated isolated dc-to-dc power supply, which eliminates the need for an external dc-to-dc isolation block.

They are designed for balanced transmission lines and comply with ANSI/TIA/EIA-485-A-98 and ISO 8482:1987(E).

The devices integrate Analog Devices, Inc., *iCoupler*[®] technology to combine a 3-channel isolator, a three-state differential line driver, a differential input receiver, and Analog Devices *isoPower* dc-to-dc converter into a single package. The devices are powered by a single 5 V or 3.3 V supply, realizing a fully integrated signal and power isolated RS-485 solution.

Rev. 0

Information furnished by Analog Devices is believed to be accurate and reliable. However, no responsibility is assumed by Analog Devices for its use, nor for any infringements of patents or other rights of third parties that may result from its use. Specifications subject to change without notice. No license is granted by implication or otherwise under any patent or patent rights of Analog Devices. Trademarks and registered trademarks are the property of their respective owners.

FUNCTIONAL BLOCK DIAGRAM

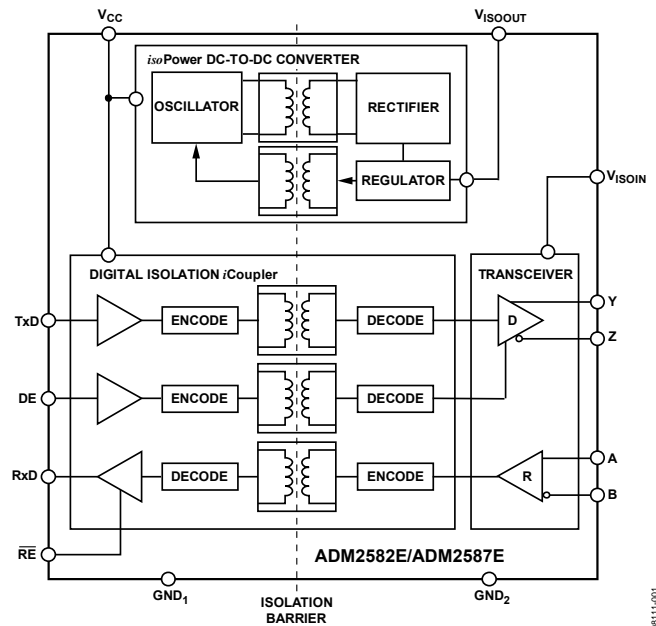

Figure 1.

The ADM2582E/ADM2587E driver has an active high enable. An active low receiver enable is also provided that causes the receiver output to enter a high impedance state when disabled.

The devices have current limiting and thermal shutdown features to protect against output short circuits and situations where bus contention may cause excessive power dissipation. The parts are fully specified over the industrial temperature range and are available in a highly integrated, 20-lead, wide-body SOIC package.

The ADM2582E/ADM2587E contain *isoPower* technology that uses high frequency switching elements to transfer power through the transformer. Special care must be taken during printed circuit board (PCB) layout to meet emissions standards. Refer to Application Note AN-0971, *Control of Radiated Emissions with isoPower Devices*, for details on board layout considerations.

TABLE OF CONTENTS

Features	1	Test Circuits.....	12
Applications.....	1	Switching Characteristics	13
Functional Block Diagram	1	Circuit Description.....	14
General Description	1	Signal Isolation	14
Revision History	2	Power Isolation	14
Specifications.....	3	Truth Tables.....	14
ADM2582E Timing Specifications	4	Thermal Shutdown	14
ADM2587E Timing Specifications	4	Open- and Short-Circuit, Fail-Safe Receiver Inputs.....	14
ADM2582E/ADM2587E Package Characteristics.....	4	DC Correctness and Magnetic Field Immunity.....	15
ADM2582E/ADM2587E Regulatory Information	5	Applications Information	16
ADM2582E/ADM2587E Insulation and Safety-Related		PCB Layout	16
Specifications	5	EMI Considerations.....	16
ADM2582E/ADM2587E VDE 0884 Insulation		Insulation Lifetime	16
Characteristics (Pending).....	5	Isolated Power Supply Considerations	17
Absolute Maximum Ratings.....	6	Typical Applications.....	19
ESD Caution.....	6	Outline Dimensions	20
Pin Configuration and Function Descriptions.....	7	Ordering Guide	20
Typical Performance Characteristics	8		

REVISION HISTORY

9/09—Revision 0: Initial Version

SPECIFICATIONS

All voltages are relative to their respective ground; $3.0 \leq V_{CC} \leq 5.5$ V. All minimum/maximum specifications apply over the entire recommended operation range, unless otherwise noted. All typical specifications are at $T_A = 25^\circ\text{C}$, $V_{CC} = 5$ V unless otherwise noted.

Table 1.

Parameter	Symbol	Min	Typ	Max	Unit	Test Conditions
ADM2587E SUPPLY CURRENT Data Rate ≤ 500 kbps	I_{CC}		90 72 125 98		mA mA mA mA	$V_{CC} = 3.3$ V, 100 Ω load between Y and Z $V_{CC} = 5$ V, 100 Ω load between Y and Z $V_{CC} = 3.3$ V, 54 Ω load between Y and Z $V_{CC} = 5$ V, 54 Ω load between Y and Z 120 Ω load between Y and Z
ADM2582E SUPPLY CURRENT Data Rate = 16 Mbps	I_{CC}			150 230	mA mA	120 Ω load between Y and Z 54 Ω load between Y and Z
ISOLATED SUPPLY VOLTAGE	V_{ISOUT}		3.3			
DRIVER						
Differential Outputs						
Differential Output Voltage, Loaded	$ V_{OD2} $	2.0		5.0	V	$R_L = 100$ Ω (RS-422), see Figure 23
		1.5		5.0	V	$R_L = 54$ Ω (RS-485), see Figure 23
	$ V_{OD3} $	1.5		5.0	V	-7 V $\leq V_{TEST1} \leq 12$ V, see Figure 24
$\Delta V_{OD} $ for Complementary Output States	$\Delta V_{OD} $			0.2	V	$R_L = 54$ Ω or 100 Ω , see Figure 23
Common-Mode Output Voltage	V_{OC}			3.0	V	$R_L = 54$ Ω or 100 Ω , see Figure 23
$\Delta V_{OC} $ for Complementary Output States	$\Delta V_{OC} $			0.2	V	$R_L = 54$ Ω or 100 Ω , see Figure 23
Short-Circuit Output Current	I_{OS}			200	mA	
Output Leakage Current (Y, Z)	I_O			30	μA	$DE = 0$ V, $\overline{RE} = 0$ V, $V_{CC} = 0$ V or 3.6 V, $V_{IN} = 12$ V
		-30			μA	$DE = 0$ V, $\overline{RE} = 0$ V, $V_{CC} = 0$ V or 3.6 V, $V_{IN} = -7$ V
Logic Inputs DE, \overline{RE} , TxD						
Input Threshold Low	V_{IL}	$0.3 \times V_{CC}$			V	DE, \overline{RE} , TxD
Input Threshold High	V_{IH}			$0.7 \times V_{CC}$	V	DE, \overline{RE} , TxD
Input Current	I_I	-10	0.01	10	μA	DE, \overline{RE} , TxD
RECEIVER						
Differential Inputs						
Differential Input Threshold Voltage	V_{TH}	-200	-125	-30	mV	-7 V $< V_{CM} < +12$ V
Input Voltage Hysteresis	V_{HYS}		15		mV	$V_{OC} = 0$ V
Input Current (A, B)	I_I			125	μA	$DE = 0$ V, $V_{CC} = 0$ V or 3.6 V, $V_{IN} = 12$ V
		-100			μA	$DE = 0$ V, $V_{CC} = 0$ V or 3.6 V, $V_{IN} = -7$ V
Line Input Resistance	R_{IN}	96			k Ω	-7 V $< V_{CM} < +12$ V
Logic Outputs						
Output Voltage Low	V_{OL}		0.2	0.4	V	$I_O = 1.5$ mA, $V_A - V_B = -0.2$ V
Output Voltage High	V_{OH}	$V_{CC} - 0.3$	$V_{CC} - 0.2$		V	$I_O = -1.5$ mA, $V_A - V_B = 0.2$ V
Short-Circuit Current				100	mA	
COMMON-MODE TRANSIENT IMMUNITY ¹		25			kV/ μs	$V_{CM} = 1$ kV, transient magnitude = 800 V

¹ CM is the maximum common-mode voltage slew rate that can be sustained while maintaining specification-compliant operation. V_{CM} is the common-mode potential difference between the logic and bus sides. The transient magnitude is the range over which the common-mode is slewed. The common-mode voltage slew rates apply to both rising and falling common-mode voltage edges.

ADM2582E/ADM2587E

ADM2582E TIMING SPECIFICATIONS

T_A = -40°C to +85°C.

Table 2.

Parameter	Symbol	Min	Typ	Max	Unit	Test Conditions
DRIVER						
Maximum Data Rate		16			Mbps	
Propagation Delay, Low to High	t _{DPLH}		63	100	ns	R _L = 54 Ω, C _{L1} = C _{L2} = 100 pF, see Figure 25 and Figure 29
Propagation Delay, High to Low	t _{DPHL}		64	100	ns	R _L = 54 Ω, C _{L1} = C _{L2} = 100 pF, see Figure 25 and Figure 29
Output Skew	t _{SKEW}		1	8	ns	R _L = 54 Ω, C _{L1} = C _{L2} = 100 pF, see Figure 25 and Figure 29
Rise Time/Fall Time	t _{DR} , t _{DF}			15	ns	R _L = 54 Ω, C _{L1} = C _{L2} = 100 pF, see Figure 25 and Figure 29
Enable Time	t _{ZL} , t _{ZH}			120	ns	R _L = 110 Ω, C _L = 50 pF, see Figure 26 and Figure 31
Disable Time	t _{LZ} , t _{HZ}			150	ns	R _L = 110 Ω, C _L = 50 pF, see Figure 26 and Figure 31
RECEIVER						
Propagation Delay, Low to High	t _{RPLH}		94	110	ns	C _L = 15 pF, see Figure 27 and Figure 30
Propagation Delay, High to Low	t _{RPHL}		95	110	ns	C _L = 15 pF, see Figure 27 and Figure 30
Output Skew ¹	t _{SKEW}		1	12	ns	C _L = 15 pF, see Figure 27 and Figure 30
Enable Time	t _{ZL} , t _{ZH}			15	ns	R _L = 1 kΩ, C _L = 15 pF, see Figure 28 and Figure 32
Disable Time	t _{LZ} , t _{HZ}			15	ns	R _L = 1 kΩ, C _L = 15 pF, see Figure 28 and Figure 32

¹ Guaranteed by design.

ADM2587E TIMING SPECIFICATIONS

T_A = -40°C to +85°C.

Table 3.

Parameter	Symbol	Min	Typ	Max	Unit	Test Conditions
DRIVER						
Maximum Data Rate		500			kbps	
Propagation Delay, Low to High	t _{DPLH}	250	503	700	ns	R _L = 54 Ω, C _{L1} = C _{L2} = 100 pF, see Figure 25 and Figure 29
Propagation Delay, High to Low	t _{DPHL}	250	510	700	ns	R _L = 54 Ω, C _{L1} = C _{L2} = 100 pF, see Figure 25 and Figure 29
Output Skew	t _{SKEW}		7	100	ns	R _L = 54 Ω, C _{L1} = C _{L2} = 100 pF, see Figure 25 and Figure 29
Rise Time/Fall Time	t _{DR} , t _{DF}	200		1100	ns	R _L = 54 Ω, C _{L1} = C _{L2} = 100 pF, see Figure 25 and Figure 29
Enable Time	t _{ZL} , t _{ZH}			2.5	μs	R _L = 110 Ω, C _L = 50 pF, see Figure 26 and Figure 31
Disable Time	t _{LZ} , t _{HZ}			200	ns	R _L = 110 Ω, C _L = 50 pF, see Figure 26 and Figure 31
RECEIVER						
Propagation Delay, Low to High	t _{RPLH}		91	200	ns	C _L = 15 pF, see Figure 27 and Figure 30
Propagation Delay, High to Low	t _{RPHL}		95	200	ns	C _L = 15 pF, see Figure 27 and Figure 30
Output Skew	t _{SKEW}		4	30	ns	C _L = 15 pF, see Figure 27 and Figure 30
Enable Time	t _{ZL} , t _{ZH}			15	ns	R _L = 1 kΩ, C _L = 15 pF, see Figure 28 and Figure 32
Disable Time	t _{LZ} , t _{HZ}			15	ns	R _L = 1 kΩ, C _L = 15 pF, see Figure 28 and Figure 32

ADM2582E/ADM2587E PACKAGE CHARACTERISTICS

Table 4.

Parameter	Symbol	Min	Typ	Max	Unit	Test Conditions
Resistance (Input-to-Output) ¹	R _{I-O}		10 ¹²		Ω	
Capacitance (Input-to-Output) ¹	C _{I-O}		3		pF	f = 1 MHz
Input Capacitance ²	C _I		4		pF	
Input IC Junction-to-Case Thermal Resistance	θ _{JCI}		33		°C/W	Thermocouple located at center of package underside
Output IC Junction-to-Case Thermal Resistance	θ _{JCO}		28		°C/W	Thermocouple located at center of package underside

¹ Device considered a 2-terminal device: short together Pin 1 to Pin 10 and short together Pin 11 to Pin 20.

² Input capacitance is from any input data pin to ground.

ADM2582E/ADM2587E REGULATORY INFORMATION

Table 5. Pending ADM2582E/ADM2587E Approvals

Organization	Approval Type	Notes
UL	To be recognized under the Component Recognition Program of Underwriters Laboratories, Inc.	In accordance with UL 1577, each ADM2582E/ADM2587E is proof tested by applying an insulation test voltage ≥ 3000 V rms for 1 second.
VDE	To be certified according to DIN V VDE V 0884-10 (VDE V 0884-10):2006-12	In accordance with VDE 0884-10, each ADM2582E/ADM2587E is proof tested by applying an insulation test voltage ≥ 1050 V _{PEAK} for 1 second.

ADM2582E/ADM2587E INSULATION AND SAFETY-RELATED SPECIFICATIONS

Table 6.

Parameter	Symbol	Value	Unit	Conditions
Rated Dielectric Insulation Voltage		2500	V rms	1-minute duration
Minimum External Air Gap (Clearance)	L(I01)	>8.0	mm	Measured from input terminals to output terminals, shortest distance through air
Minimum External Tracking (Creepage)	L(I02)	>8.0	mm	Measured from input terminals to output terminals, shortest distance along body
Minimum Internal Gap (Internal Clearance)		0.017 min	mm	Insulation distance through insulation
Tracking Resistance (Comparative Tracking Index)	CTI	>175	V	DIN IEC 112/VDE 0303-1
Isolation Group		IIla		Material Group (DIN VDE 0110: 1989-01, Table 1)

ADM2582E/ADM2587E VDE 0884 INSULATION CHARACTERISTICS (PENDING)

This isolator is suitable for basic electrical isolation only within the safety limit data. Maintenance of the safety data must be ensured by means of protective circuits.

Table 7.

Description	Conditions	Symbol	Characteristic	Unit
CLASSIFICATIONS				
Installation Classification per DIN VDE 0110 for Rated Mains Voltage			I to IV	
≤ 150 V rms			I to III	
≤ 300 V rms			I to II	
≤ 400 V rms			40/85/21	
Climatic Classification			2	
Pollution Degree	DIN VDE 0110, see Table 1			
VOLTAGE				
Maximum Working Insulation Voltage		V _{IORM}	560	V peak
Input-to-Output Test Voltage		V _{PR}	1050	V peak
Method b1	V _{IORM} × 1.875 = V _{PR} , 100% production tested, t _m = 1 sec, partial discharge < 5 pC			
Method a				
After Environmental Tests, Subgroup 1	V _{IORM} × 1.6 = V _{PR} , t _m = 60 sec, partial discharge < 5 pC		896	V peak
After Input and/or Safety Test, Subgroup 2/Subgroup 3	V _{IORM} × 1.2 = V _{PR} , t _m = 60 sec, partial discharge < 5 pC		672	V peak
Highest Allowable Overvoltage	Transient overvoltage, t _{TR} = 10 sec	V _{TR}	4000	V peak
SAFETY-LIMITING VALUES	Maximum value allowed in the event of a failure			
Case Temperature		T _S	150	°C
Input Current		I _{S, INPUT}	265	mA
Output Current		I _{S, OUTPUT}	335	mA
Insulation Resistance at T _S	V _{IO} = 500 V	R _S	>10 ⁹	Ω

ADM2582E/ADM2587E

ABSOLUTE MAXIMUM RATINGS

T_A = 25°C, unless otherwise noted. All voltages are relative to their respective ground.

Table 8.

Parameter	Rating
V _{CC}	−0.5 V to +7 V
Digital Input Voltage (DE, \overline{RE} , TxD)	−0.5 V to V _{DD} + 0.5 V
Digital Output Voltage (RxD)	−0.5 V to V _{DD} + 0.5 V
Driver Output/Receiver Input Voltage	−9 V to +14 V
Operating Temperature Range	−40°C to +85°C
Storage Temperature Range	−55°C to +150°C
ESD (Human Body Model) on A, B, Y, and Z pins	±15 kV
ESD (Human Body Model) on Other Pins	±2 kV
Lead Temperature	
Soldering (10 sec)	260°C
Vapor Phase (60 sec)	215°C
Infrared (15 sec)	220°C

Stresses above those listed under Absolute Maximum Ratings may cause permanent damage to the device. This is a stress rating only; functional operation of the device at these or any other conditions above those indicated in the operational section of this specification is not implied. Exposure to absolute maximum rating conditions for extended periods may affect device reliability.

Table 9. Maximum Continuous Working Voltage¹

Parameter	Max	Unit	Reference Standard
AC Voltage			
Bipolar Waveform	424	V peak	50-year minimum lifetime
Unipolar Waveform			
Basic Insulation	600	V peak	Maximum approved working voltage per IEC 60950-1 (pending)
Reinforced Insulation	560	V peak	Maximum approved working voltage per IEC 60950-1 and VDEV 0884-10 (pending)
DC Voltage			
Basic Insulation	600	V peak	Maximum approved working voltage per IEC 60950-1 (pending)
Reinforced Insulation	560	V peak	Maximum approved working voltage per IEC 60950-1 and VDEV 0884-10 (pending)

¹ Refers to continuous voltage magnitude imposed across the isolation barrier. See the Insulation Lifetime section for more details.

ESD CAUTION



ESD (electrostatic discharge) sensitive device. Charged devices and circuit boards can discharge without detection. Although this product features patented or proprietary protection circuitry, damage may occur on devices subjected to high energy ESD. Therefore, proper ESD precautions should be taken to avoid performance degradation or loss of functionality.

PIN CONFIGURATION AND FUNCTION DESCRIPTIONS

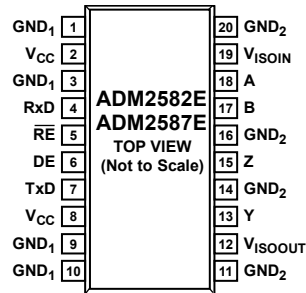

NOTES
1. PIN 12 AND PIN 19 MUST BE CONNECTED EXTERNALLY.

08111-002

Figure 2. Pin Configuration

Table 10. Pin Function Description

Pin No.	Mnemonic	Description
1	GND ₁	Ground, Logic Side.
2	V _{CC}	Logic Side Power Supply. It is recommended that a 0.1 μF and a 10 μF decoupling capacitor be fitted between Pin 2 and Pin 1.
3	GND ₁	Ground, Logic Side.
4	RxD	Receiver Output Data. This output is high when (A – B) > 200 mV and low when (A – B) < –200 mV. The output is tristated when the receiver is disabled, that is, when \overline{RE} is driven high.
5	\overline{RE}	Receiver Enable Input. This is an active-low input. Driving this input low enables the receiver; driving it high disables the receiver.
6	DE	Driver Enable Input. Driving this input high enables the driver; driving it low disables the driver.
7	TxD	Driver Input. Data to be transmitted by the driver is applied to this input.
8	V _{CC}	Logic Side Power Supply. It is recommended that a 0.1 μF and a 0.01 μF decoupling capacitor be fitted between Pin 8 and Pin 7.
9	GND ₁	Ground, Logic Side.
10	GND ₁	Ground, Logic Side.
11	GND ₂	Ground, Bus Side.
12	V _{ISOOUT}	Isolated Power Supply Output. This pin must be connected externally to V _{ISOIN} . It is recommended that a reservoir capacitor of 10 μF and a decoupling capacitor of 0.1 μF be fitted between Pin 12 and Pin 11.
13	Y	Driver Noninverting Output
14	GND ₂	Ground, Bus Side.
15	Z	Driver Inverting Output
16	GND ₂	Ground, Bus Side.
17	B	Receiver Inverting Input.
18	A	Receiver Noninverting Input.
19	V _{ISOIN}	Isolated Power Supply Input. This pin must be connected externally to V _{ISOOUT} . It is recommended that a 0.1 μF and a 0.01 μF decoupling capacitor be fitted between Pin 19 and Pin 20.
20	GND ₂	Ground, Bus Side.

TYPICAL PERFORMANCE CHARACTERISTICS

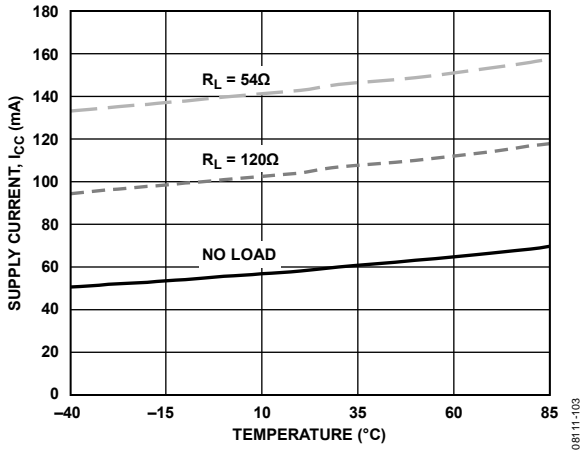

Figure 3. ADM2582E Supply Current (I_{CC}) vs. Temperature (Data Rate = 16 Mbps, DE = 3.3 V, V_{CC} = 3.3 V)

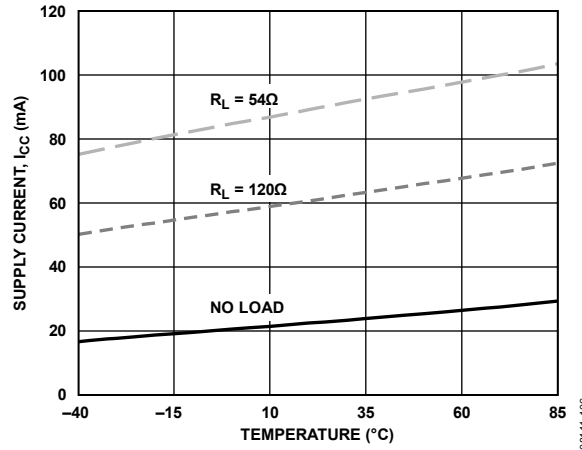

Figure 6. ADM2587E Supply Current (I_{CC}) vs. Temperature (Data Rate = 500 kbps, DE = 3.3 V, V_{CC} = 3.3 V)

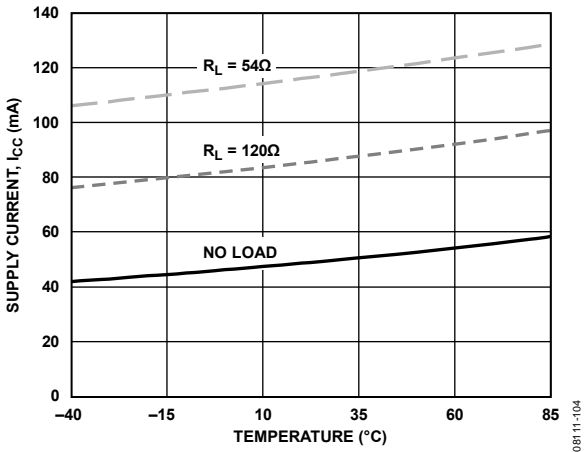

Figure 4. ADM2582E Supply Current (I_{CC}) vs. Temperature (Data Rate = 16 Mbps, DE = 5 V, V_{CC} = 5 V)

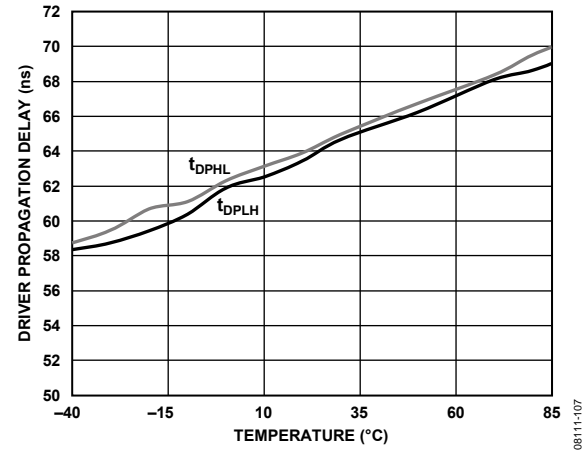

Figure 7. ADM2582E Differential Driver Propagation Delay vs. Temperature

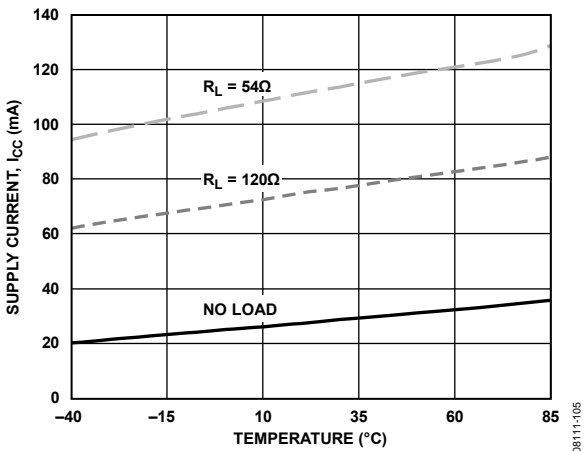

Figure 5. ADM2587E Supply Current (I_{CC}) vs. Temperature (Data Rate = 500 kbps, DE = 5 V, V_{CC} = 5 V)

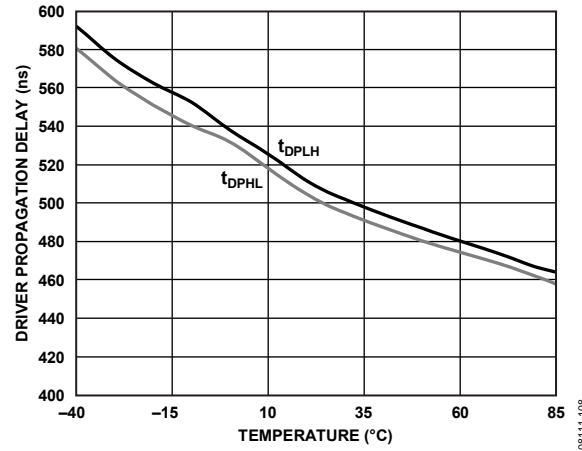

Figure 8. ADM2587E Differential Driver Propagation Delay vs. Temperature

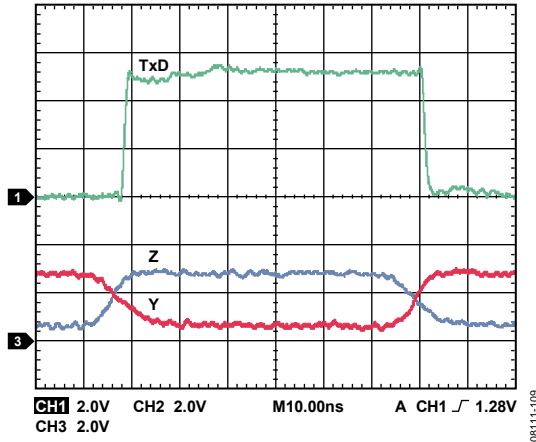

Figure 9. ADM2582E Driver Propagation Delay

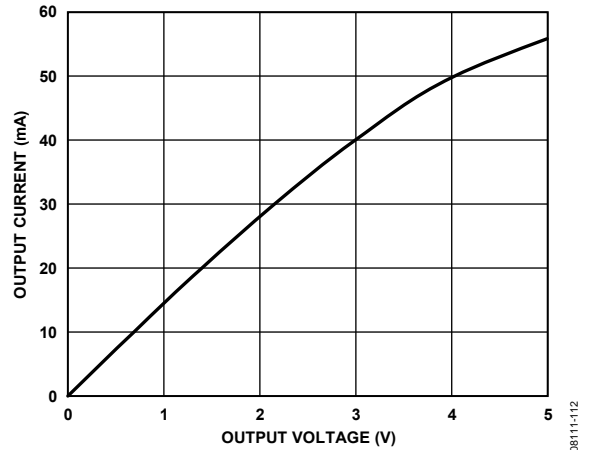

Figure 12. Receiver Output Current vs. Receiver Output Low Voltage

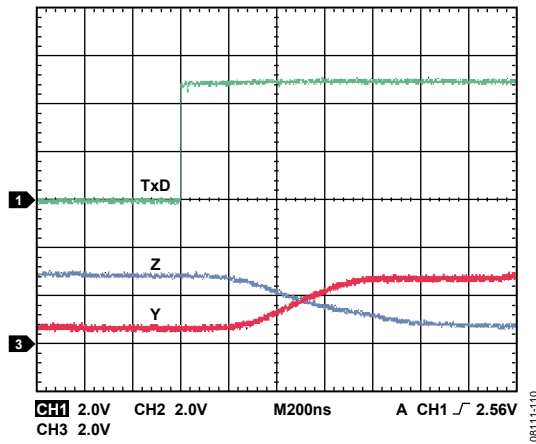

Figure 10. ADM2587E Driver Propagation Delay

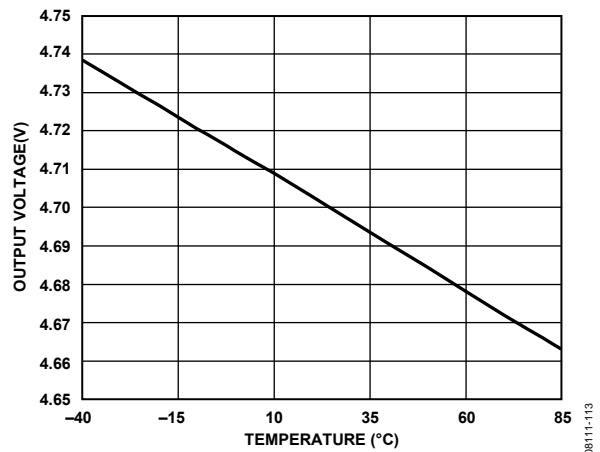

Figure 13. Receiver Output High Voltage vs. Temperature

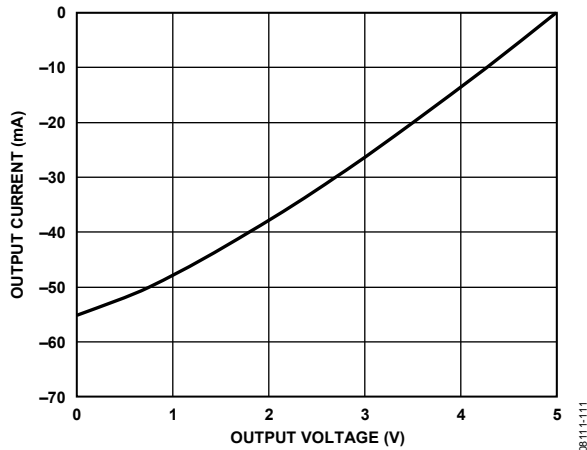

Figure 11. Receiver Output Current vs. Receiver Output High Voltage

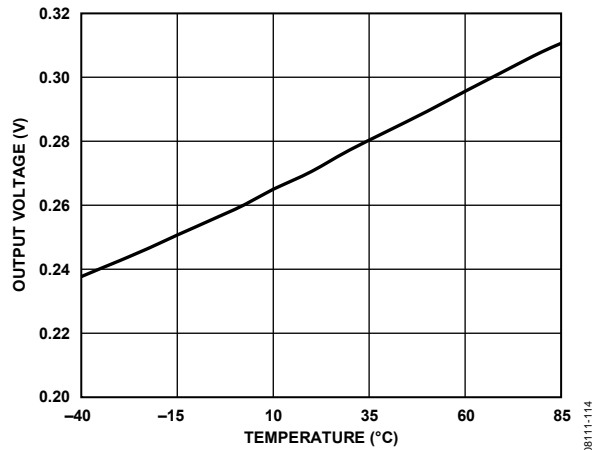

Figure 14. Receiver Output Low Voltage vs. Temperature

ADM2582E/ADM2587E

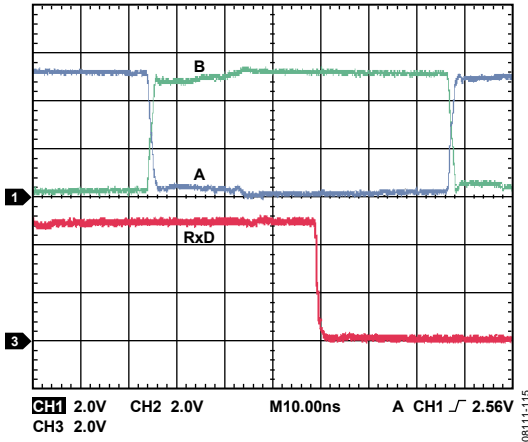

Figure 15. ADM2582E Receiver Propagation Delay

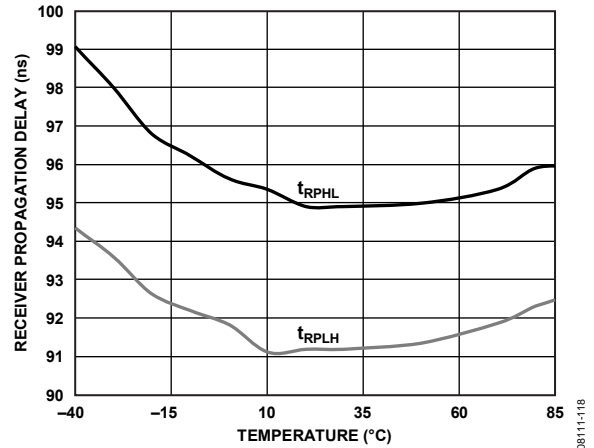

Figure 18. ADM2587E Receiver Propagation Delay vs. Temperature

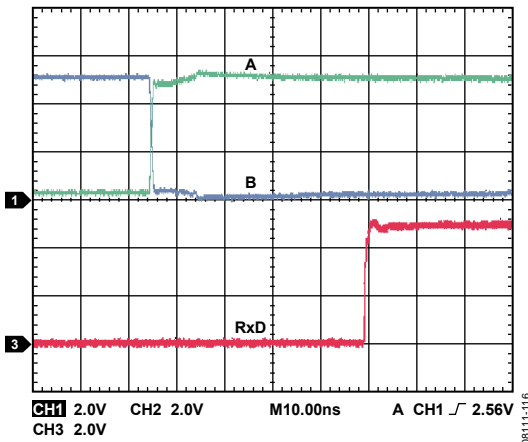

Figure 16. ADM2587E Receiver Propagation Delay

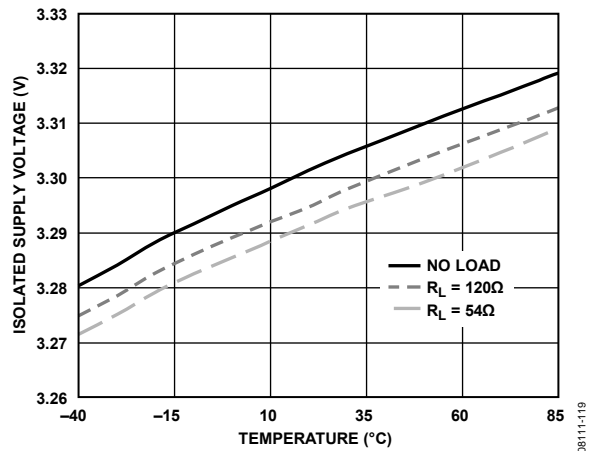

Figure 19. ADM2582E Isolated Supply Voltage vs. Temperature ($V_{CC} = 3.3V$, Data Rate = 16 Mbps)

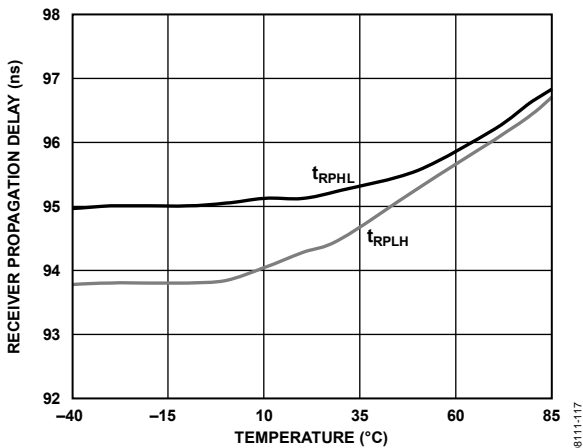

Figure 17. ADM2582E Receiver Propagation Delay vs. Temperature

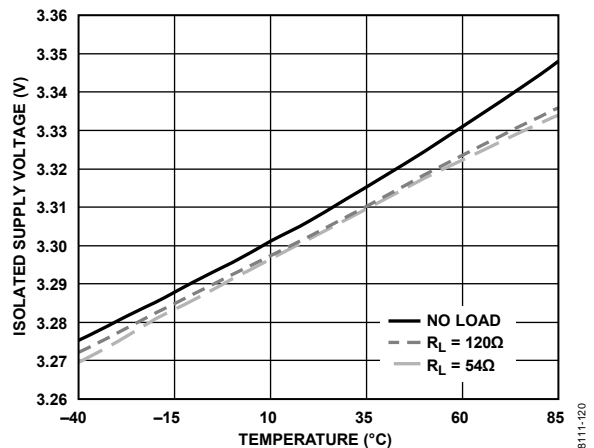

Figure 20. ADM2582E Isolated Supply Voltage vs. Temperature ($V_{CC} = 5V$, Data Rate = 16 Mbps)

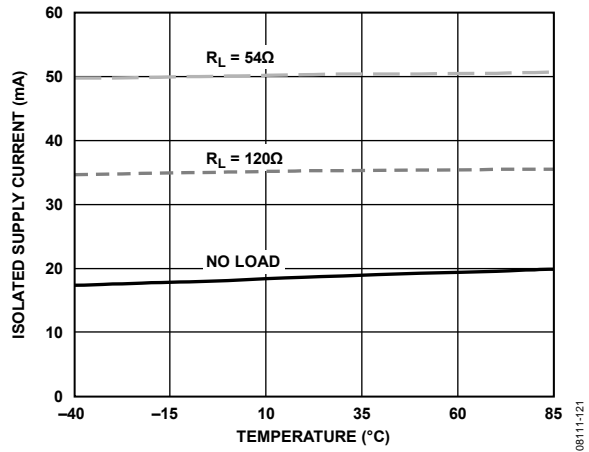

Figure 21. ADM2582E Isolated Supply Current vs. Temperature ($V_{CC} = 3.3\text{ V}$, Data Rate = 16 Mbps)

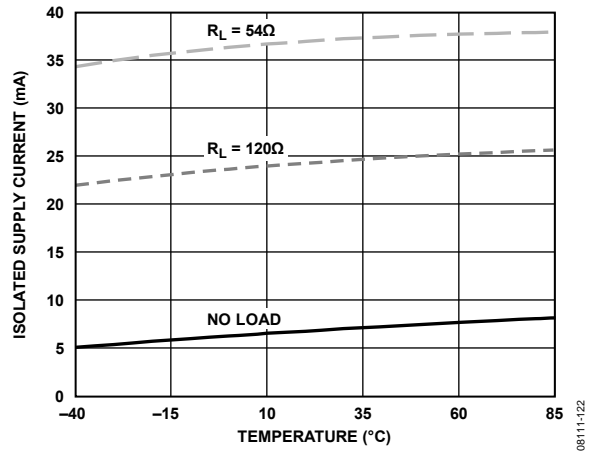

Figure 22. ADM2587E Isolated Supply Current vs. Temperature ($V_{CC} = 3.3\text{ V}$, Data Rate = 500 kbps)

TEST CIRCUITS

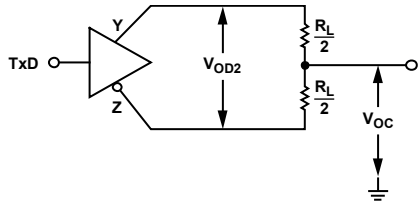

Figure 23. Driver Voltage Measurement

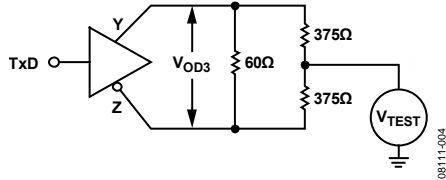

Figure 24. Driver Voltage Measurement

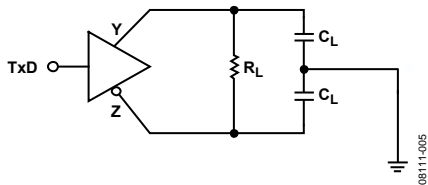

Figure 25. Driver Propagation Delay

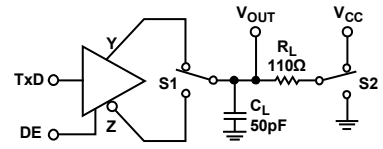

Figure 26. Driver Enable/Disable

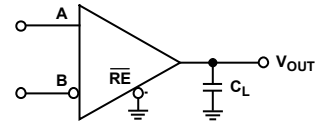

Figure 27. Receiver Propagation Delay

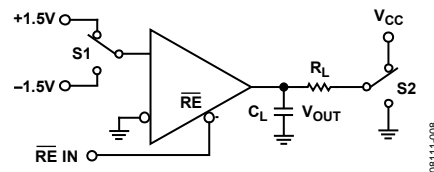

Figure 28. Receiver Enable/Disable

SWITCHING CHARACTERISTICS

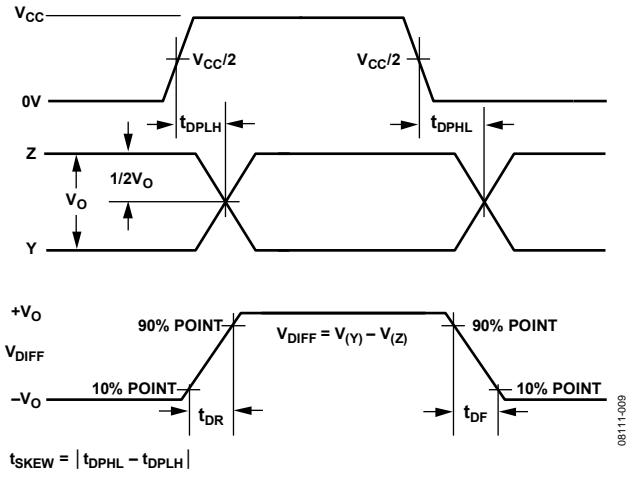

Figure 29. Driver Propagation Delay, Rise/Fall Timing

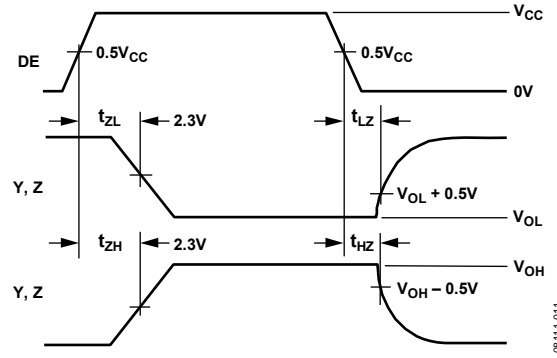

Figure 31. Driver Enable/Disable Timing

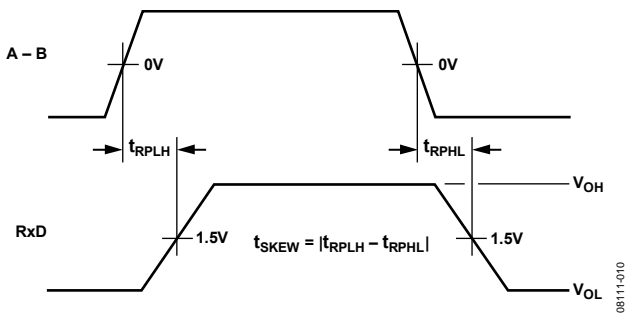

Figure 30. Receiver Propagation Delay

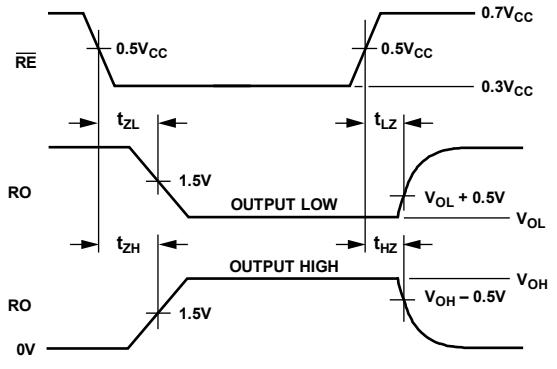

Figure 32. Receiver Enable/Disable Timing

ADM2582E/ADM2587E

CIRCUIT DESCRIPTION

SIGNAL ISOLATION

The ADM2582E/ADM2587E signal isolation is implemented on the logic side of the interface. The part achieves signal isolation by having a digital isolation section and a transceiver section (see Figure 1). Data applied to the TxD and DE pins and referenced to logic ground (GND₁) are coupled across an isolation barrier to appear at the transceiver section referenced to isolated ground (GND₂). Similarly, the single-ended receiver output signal, referenced to isolated ground in the transceiver section, is coupled across the isolation barrier to appear at the RXD pin referenced to logic ground.

POWER ISOLATION

The ADM2582E/ADM2587E power isolation is implemented using an *isoPower* integrated isolated dc-to-dc converter. The dc-to-dc converter section of the ADM2582E/ADM2587E works on principles that are common to most modern power supplies. It is a secondary side controller architecture with isolated pulse-width modulation (PWM) feedback. V_{CC} power is supplied to an oscillating circuit that switches current into a chip-scale air core transformer. Power transferred to the secondary side is rectified and regulated to 3.3 V. The secondary (V_{ISO}) side controller regulates the output by creating a PWM control signal that is sent to the primary (V_{CC}) side by a dedicated *iCoupler* data channel. The PWM modulates the oscillator circuit to control the power being sent to the secondary side. Feedback allows for significantly higher power and efficiency.

TRUTH TABLES

The truth tables in this section use the abbreviations found in Table 11.

Table 11. Truth Table Abbreviations

Letter	Description
H	High level
L	Low level
X	Don't care
Z	High impedance (off)
NC	Disconnected

Table 12. Transmitting (see Table 11 for Abbreviations)

Inputs		Outputs	
DE	TxD	Y	Z
H	H	H	L
H	L	L	H
L	X	Z	Z
X	X	Z	Z
L	X	Z	Z
X	X	Z	Z

Table 13. Receiving (see Table 11 for Abbreviations)

Inputs		Output
A – B	\overline{RE}	RxD
> –0.03 V	L or NC	H
< –0.2 V	L or NC	L
–0.2 V < A – B < –0.03 V	L or NC	X
Inputs open	L or NC	H
X	H	Z
X	L or NC	H
X	L or NC	L

THERMAL SHUTDOWN

The ADM2582E/ADM2587E contain thermal shutdown circuitry that protects the parts from excessive power dissipation during fault conditions. Shorting the driver outputs to a low impedance source can result in high driver currents. The thermal sensing circuitry detects the increase in die temperature under this condition and disables the driver outputs. This circuitry is designed to disable the driver outputs when a die temperature of 150°C is reached. As the device cools, the drivers are reenabled at a temperature of 140°C.

OPEN- AND SHORT-CIRCUIT, FAIL-SAFE RECEIVER INPUTS

The receiver inputs have open- and short-circuit, fail-safe features that ensure that the receiver output is high when the inputs are open or shorted. During line-idle conditions, when no driver on the bus is enabled, the voltage across a terminating resistance at the receiver input decays to 0 V. With traditional transceivers, receiver input thresholds specified between –200 mV and +200 mV mean that external bias resistors are required on the A and B pins to ensure that the receiver outputs are in a known state. The short-circuit, fail-safe receiver input feature eliminates the need for bias resistors by specifying the receiver input threshold between –30 mV and –200 mV. The guaranteed negative threshold means that when the voltage between A and B decays to 0 V, the receiver output is guaranteed to be high.

DC CORRECTNESS AND MAGNETIC FIELD IMMUNITY

The digital signals transmit across the isolation barrier using *iCoupler* technology. This technique uses chip-scale transformer windings to couple the digital signals magnetically from one side of the barrier to the other. Digital inputs are encoded into waveforms that are capable of exciting the primary transformer winding. At the secondary winding, the induced waveforms are decoded into the binary value that was originally transmitted.

Positive and negative logic transitions at the isolator input cause narrow (~1 ns) pulses to be sent to the decoder via the transformer. The decoder is bistable and is, therefore, either set or reset by the pulses, indicating input logic transitions. In the absence of logic transitions at the input for more than 1 μs, periodic sets of refresh pulses indicative of the correct input state are sent to ensure dc correctness at the output. If the decoder receives no internal pulses of more than approximately 5 μs, the input side is assumed to be unpowered or nonfunctional, in which case, the isolator output is forced to a default state by the watchdog timer circuit.

This situation should occur in the ADM2582E/ADM2587E devices only during power-up and power-down operations. The limitation on the ADM2582E/ADM2587E magnetic field immunity is set by the condition in which induced voltage in the transformer receiving coil is sufficiently large to either falsely set or reset the decoder. The following analysis defines the conditions under which this can occur.

The 3.3 V operating condition of the ADM2582E/ADM2587E is examined because it represents the most susceptible mode of operation. The pulses at the transformer output have an amplitude of >1.0 V. The decoder has a sensing threshold of about 0.5 V, thus establishing a 0.5 V margin in which induced voltages can be tolerated. The voltage induced across the receiving coil is given by

$$V = (-d\beta/dt)\Sigma\pi r_n^2; n = 1, 2, \dots, N$$

where:

β is magnetic flux density (gauss).

N is the number of turns in the receiving coil.

r_n is the radius of the n th turn in the receiving coil (cm).

Given the geometry of the receiving coil in the ADM2582E/ADM2587E and an imposed requirement that the induced voltage be, at most, 50% of the 0.5 V margin at the decoder, a maximum allowable magnetic field is calculated as shown in Figure 33.

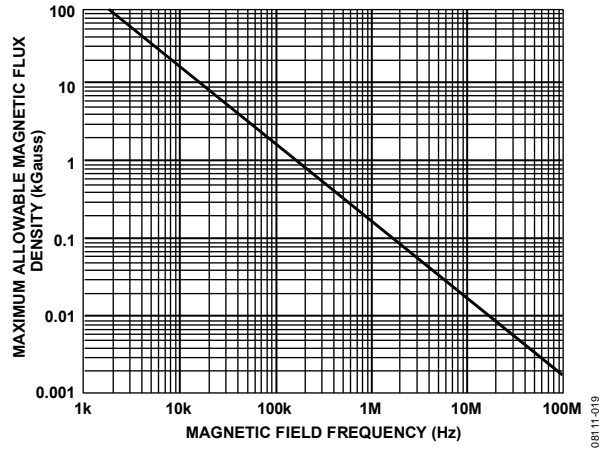

Figure 33. Maximum Allowable External Magnetic Flux Density

For example, at a magnetic field frequency of 1 MHz, the maximum allowable magnetic field of 0.2 kgauss induces a voltage of 0.25 V at the receiving coil. This is about 50% of the sensing threshold and does not cause a faulty output transition. Similarly, if such an event occurs during a transmitted pulse (and is of the worst-case polarity), it reduces the received pulse from >1.0 V to 0.75 V, which is still well above the 0.5 V sensing threshold of the decoder.

The preceding magnetic flux density values correspond to specific current magnitudes at given distances from the ADM2582E/ADM2587E transformers. Figure 34 expresses these allowable current magnitudes as a function of frequency for selected distances. As shown in Figure 34, the ADM2582E/ADM2587E are extremely immune and can be affected only by extremely large currents operated at high frequency very close to the component. For the 1 MHz example, a 0.5 kA current must be placed 5 mm away from the ADM2582E/ADM2587E to affect component operation.

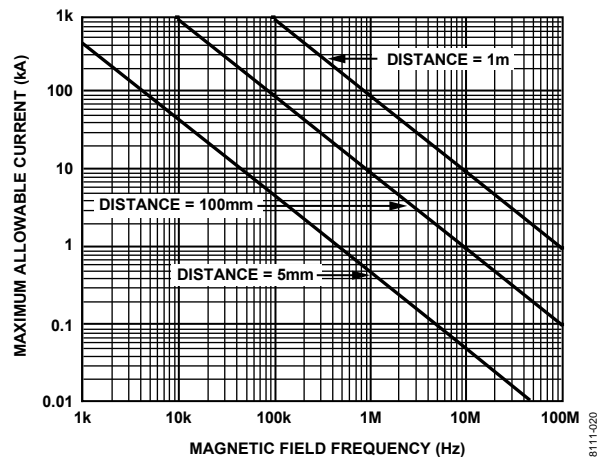

Figure 34. Maximum Allowable Current for Various Current-to-ADM2582E/ADM2587E Spacings

Note that in combinations of strong magnetic field and high frequency, any loops formed by printed circuit board (PCB) traces can induce error voltages sufficiently large to trigger the thresholds of succeeding circuitry. Take care in the layout of such traces to avoid this possibility.

APPLICATIONS INFORMATION

PCB LAYOUT

The ADM2582E/ADM2587E isolated RS-422/RS-485 transceiver contains an *isoPower* integrated dc-to-dc converter, requiring no external interface circuitry for the logic interfaces. Power supply bypassing is required at the input and output supply pins (see Figure 35). The power supply section of the ADM2582E/ADM2587E uses an 180 MHz oscillator frequency to pass power efficiently through its chip-scale transformers. In addition, the normal operation of the data section of the *iCoupler* introduces switching transients on the power supply pins.

Bypass capacitors are required for several operating frequencies. Noise suppression requires a low inductance, high frequency capacitor, whereas ripple suppression and proper regulation require a large value capacitor. These capacitors are connected between Pin 1 (GND₁) and Pin 2 (V_{CC}) and Pin 8 (V_{CC}) and Pin 9 (GND₁) for V_{CC}. The V_{ISOIN} and V_{ISOOUT} capacitors are connected between Pin 11 (GND₂) and Pin 12 (V_{ISOOUT}) and Pin 19 (V_{ISOIN}) and Pin 20 (GND₂). To suppress noise and reduce ripple, a parallel combination of at least two capacitors is required. The recommended capacitor values are 0.1 μF and 10 μF. The recommended best practice is to use a very low inductance ceramic capacitor, or its equivalent, for the smaller value. The total lead length between both ends of the capacitor and the input power supply pin should not exceed 10 mm.

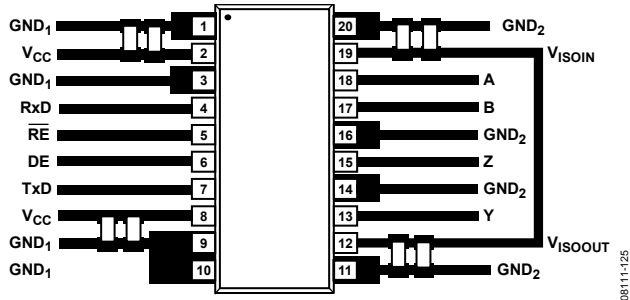

Figure 35. Recommended PCB Layout

In applications involving high common-mode transients, ensure that board coupling across the isolation barrier is minimized. Furthermore, design the board layout such that any coupling that does occur equally affects all pins on a given component side. Failure to ensure this can cause voltage differentials between pins exceeding the absolute maximum ratings for the device, thereby leading to latch-up and/or permanent damage.

The ADM2582E/ADM2587E dissipate approximately 650 mW of power when fully loaded. Because it is not possible to apply a heat sink to an isolation device, the devices primarily depend on heat dissipation into the PCB through the GND pins. If the devices are used at high ambient temperatures, provide a thermal path from the GND pins to the PCB ground plane. The board layout in Figure 35 shows enlarged pads for Pin 1, Pin 3, Pin 9, Pin 10, Pin 11, Pin 14, Pin 16, and Pin 20. Implement multiple vias from the pad to the ground plane to reduce the temperature inside the chip significantly. The dimensions of the expanded pads are at the discretion of the designer and dependent on the available board space.

EMI CONSIDERATIONS

The dc-to-dc converter section of the ADM2582E/ADM2587E components must, of necessity, operate at very high frequency to allow efficient power transfer through the small transformers. This creates high frequency currents that can propagate in circuit board ground and power planes, causing edge and dipole radiation. Grounded enclosures are recommended for applications that use these devices. If grounded enclosures are not possible, good RF design practices should be followed in the layout of the PCB. See Application Note AN-0971, *Control of Radiated Emissions with isoPower Devices*, for more information.

INSULATION LIFETIME

All insulation structures eventually break down when subjected to voltage stress over a sufficiently long period. The rate of insulation degradation is dependent on the characteristics of the voltage waveform applied across the insulation. Analog Devices conducts an extensive set of evaluations to determine the lifetime of the insulation structure within the ADM2582E/ADM2587E.

Accelerated life testing is performed using voltage levels higher than the rated continuous working voltage. Acceleration factors for several operating conditions are determined, allowing calculation of the time to failure at the working voltage of interest. The values shown in Table 9 summarize the peak voltages for 50 years of service life in several operating conditions. In many cases, the working voltage approved by agency testing is higher than the 50-year service life voltage. Operation at working voltages higher than the service life voltage listed leads to premature insulation failure.

The insulation lifetime of the ADM2582E/ADM2587E depends on the voltage waveform type imposed across the isolation barrier. The *iCoupler* insulation structure degrades at different rates, depending on whether the waveform is bipolar ac, unipolar ac, or dc. Figure 36, Figure 37, and Figure 38 illustrate these different insulation voltage waveforms.

Bipolar ac voltage is the most stringent environment. A 50-year operating lifetime under the bipolar ac condition determines the Analog Devices recommended maximum working voltage.

In the case of unipolar ac or dc voltage, the stress on the insulation is significantly lower. This allows operation at higher working voltages while still achieving a 50-year service life. The working voltages listed in Table 9 can be applied while maintaining the 50-year minimum lifetime, provided the voltage conforms to either the unipolar ac or dc voltage cases. Any crossinsulation voltage waveform that does not conform to Figure 37 or Figure 38 should be treated as a bipolar ac waveform, and its peak voltage should be limited to the 50-year lifetime voltage value listed in Table 9.

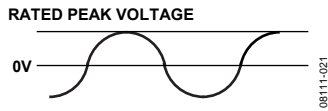

Figure 36. Bipolar AC Waveform

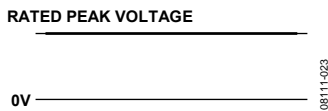
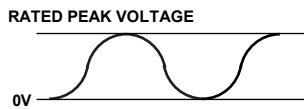

Figure 37. DC Waveform



NOTES
 1. THE VOLTAGE IS SHOWN AS SINUSOIDAL FOR ILLUSTRATION PURPOSES ONLY. IT IS MEANT TO REPRESENT ANY VOLTAGE WAVEFORM VARYING BETWEEN 0 AND SOME LIMITING VALUE. THE LIMITING VALUE CAN BE POSITIVE OR NEGATIVE, BUT THE VOLTAGE CANNOT CROSS 0V.

Figure 38. Unipolar AC Waveform

ISOLATED POWER SUPPLY CONSIDERATIONS

The typical output voltage of the integrated *isoPower* dc-to-dc isolated supply is 3.3 V. The isolated supply in the ADM2587E is capable of supplying a current of 55 mA when the junction temperature of the device is kept below 120°C. It is important to note that the current available on the V_{ISOOUT} pin is the total current available and includes the current required to supply the internal RS-485 circuitry.

The ADM2587E can typically supply 15 mA externally on V_{ISOOUT} when the driver is switching at 500 kbps loaded with 54 Ω, while the junction temperature of the part is less than 120°C.

Table 14. Typical Maximum External Current Available on V_{ISOOUT}

External Load Current (mA)	R_T	System Configuration
15	54 Ω	Double terminated bus with $R_T = 110\ \Omega$
29	120 Ω	Single terminated bus
46	Unloaded	Unterminated bus

The ADM2582E typically has no current available externally on V_{ISOOUT} .

When external current is drawn from the V_{ISOOUT} pin, there is an increased risk of generating radiated emissions due to the high frequency switching elements used in the *isoPower* dc to dc converter. Special care must be taken during PCB layout to meet emissions standards. See Application Note AN-0971, *Control of Radiated Emissions with isoPower Devices*, for details on board layout considerations.

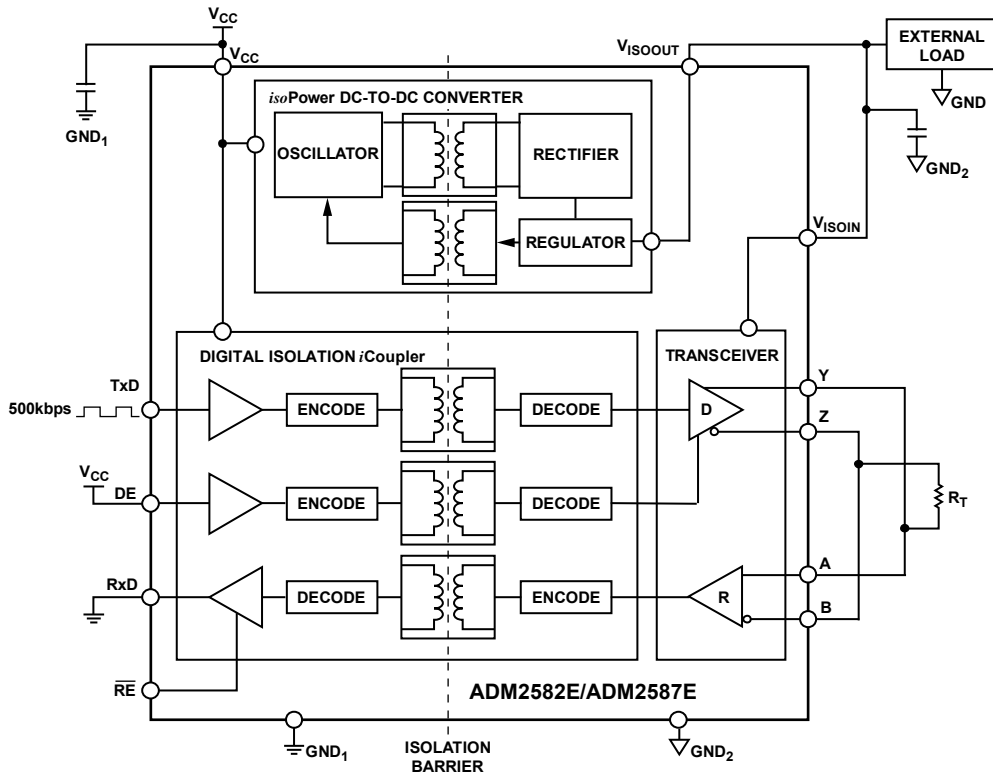
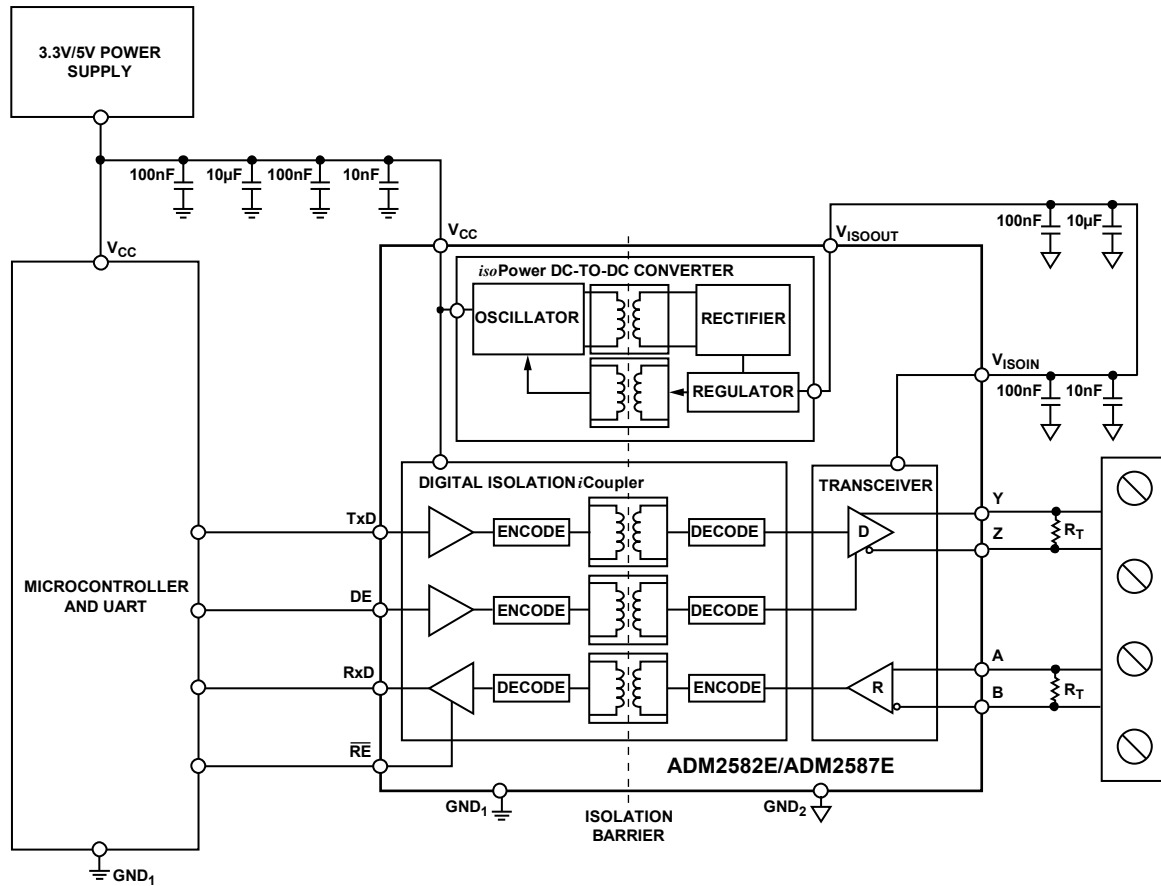

Figure 39. ADM2587E Typical Maximum External Current Measurements
 Rev. 0 | Page 17 of 20

08111-038

ADM2582E/ADM2587E



08111-124

Figure 40. Example Circuit Diagram Using the ADM2582E/ADM2587E

Figure 40 is an example of a circuit diagram using the ADM2582E/ADM2587E.

TYPICAL APPLICATIONS

Figure 41 and Figure 42 show typical applications of the ADM2582E/ADM2587E in half duplex and full duplex RS-485 network configurations. Up to 256 transceivers can be connected to the RS-485 bus. To minimize reflections, terminate the line at the

receiving end in its characteristic impedance, and keep stub lengths off the main line as short as possible. For half-duplex operation, this means that both ends of the line must be terminated because either end can be the receiving end.

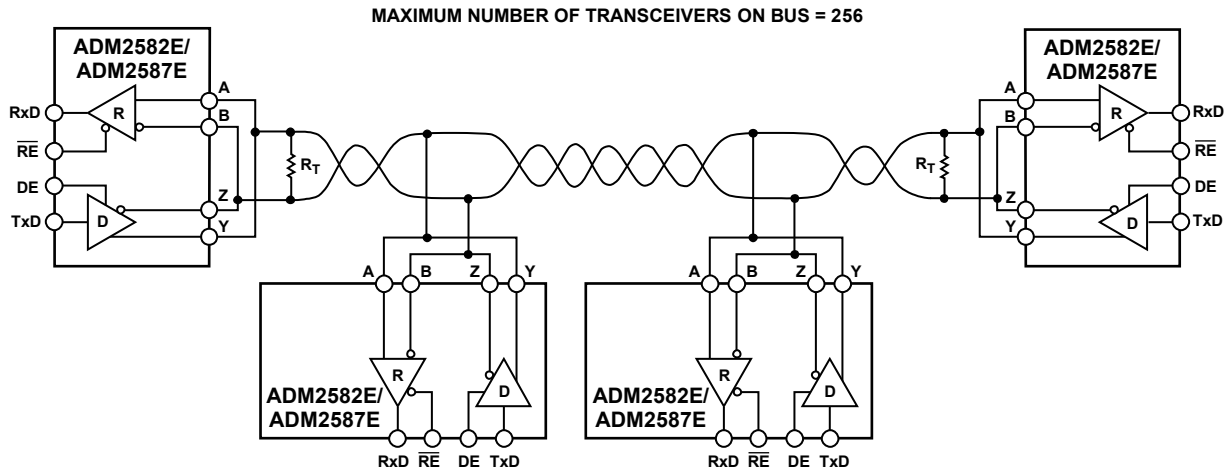

- NOTES**
1. R_T IS EQUAL TO THE CHARACTERISTIC IMPEDANCE OF THE CABLE.
 2. ISOLATION NOT SHOWN.

Figure 41. ADM2582E/ADM2587E Typical Half Duplex RS-485 Network

08111-027

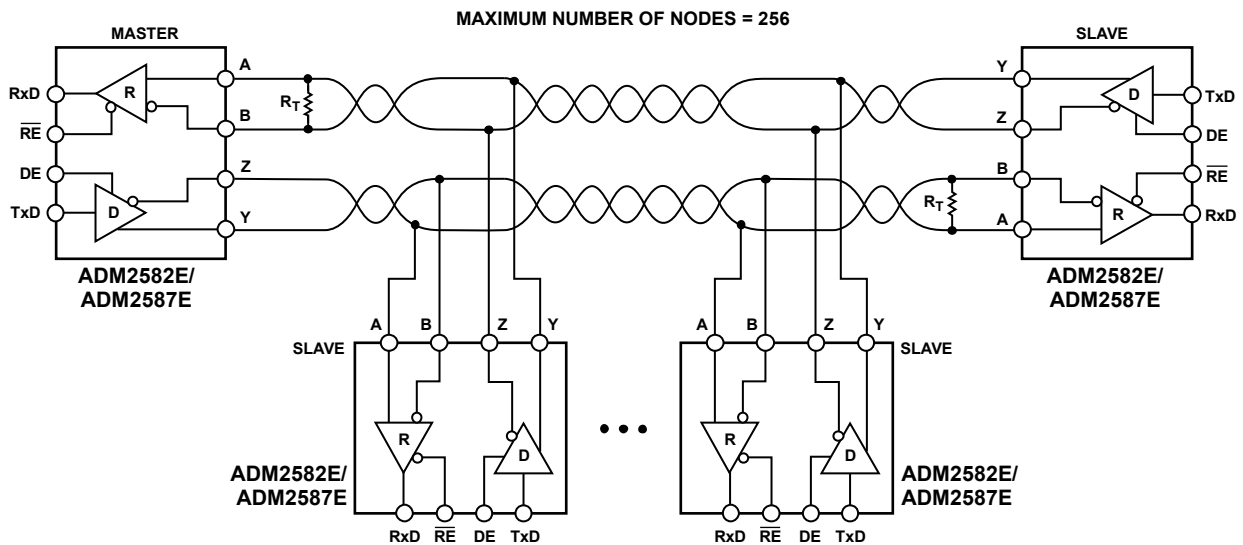

- NOTES**
1. R_T IS EQUAL TO THE CHARACTERISTIC IMPEDANCE OF THE CABLE.
 2. ISOLATION NOT SHOWN.

Figure 42. ADM2582E/ADM2587E Typical Full Duplex RS-485 Network

08111-028

ADM2582E/ADM2587E

OUTLINE DIMENSIONS

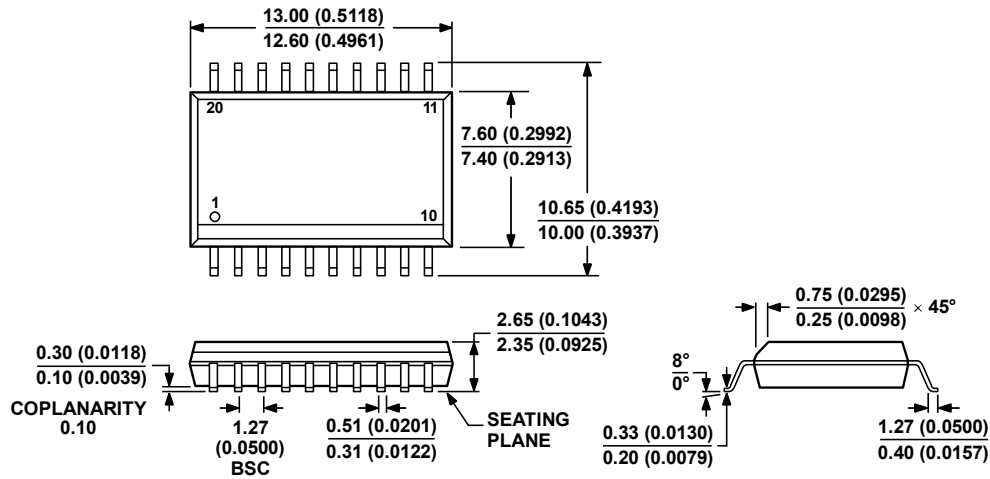

COMPLIANT TO JEDEC STANDARDS MS-013-AC
 CONTROLLING DIMENSIONS ARE IN MILLIMETERS; INCH DIMENSIONS
 (IN PARENTHESES) ARE ROUNDED-OFF MILLIMETER EQUIVALENTS FOR
 REFERENCE ONLY AND ARE NOT APPROPRIATE FOR USE IN DESIGN.

Figure 43. 20-Lead Standard Small Outline Package [SOIC_W]
 Wide Body
 (RW-20)

Dimensions shown in millimeters and (inches)

0607.06-A

ORDERING GUIDE

Model	Data Rate (Mbps)	Temperature Range	Package Description	Package Option
ADM2582EBRWZ ¹	16	-40°C to +85°C	20-Lead SOIC_W	RW-20
ADM2582EBRWZ-REEL7 ¹	16	-40°C to +85°C	20-Lead SOIC_W	RW-20
ADM2587EBRWZ ¹	0.5	-40°C to +85°C	20-Lead SOIC_W	RW-20
ADM2587EBRWZ-REEL7 ¹	0.5	-40°C to +85°C	20-Lead SOIC_W	RW-20
EVAL-ADM2582EEBZ ¹			ADM2582E Evaluation Board	
EVAL-ADM2587EEBZ ¹			ADM2587E Evaluation Board	

¹ Z = RoHS Compliant Part.