

Darlington

2SD2081

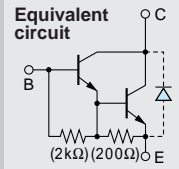

Silicon NPN Triple Diffused Planar Transistor (Complement to type 2SB1259)

Application : Driver for Solenoid, Motor and General Purpose

Absolute maximum ratings (Ta=25°C)

Symbol	Ratings	Unit
V _{CB0}	120	V
V _{CEO}	120	V
V _{EB0}	6	V
I _C	10(Pulse15)	A
I _B	1	A
P _C	30(T _C =25°C)	W
T _J	150	°C
T _{stg}	-55 to +150	°C

Electrical Characteristics (Ta=25°C)

Symbol	Conditions	Ratings	Unit
I _{CB0}	V _{CB} =120V	10max	μA
I _{EB0}	V _{EB} =6V	10max	mA
V(BR) _{CEO}	I _C =10mA	120min	V
h _{FE}	V _{CE} =4V, I _C =5A	2000min	
V _{CE(sat)}	I _C =5A, I _B =5mA	1.5max	V
V _{BE(sat)}	I _C =5A, I _B =5mA	2.0max	V
f _T	V _{CE} =12V, I _E =-0.5A	60typ	MHZ
C _{OB}	V _{CB} =10V, f=1MHZ	95typ	pF

External Dimensions FM20(TO220F)

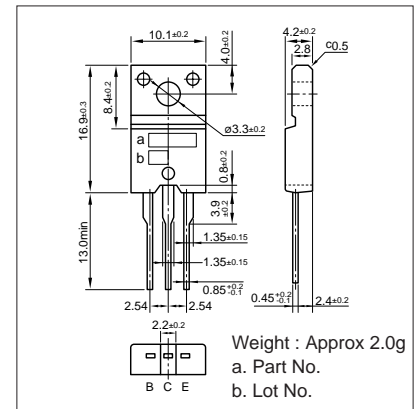

I_C-V_{CE} Characteristics (Typical)

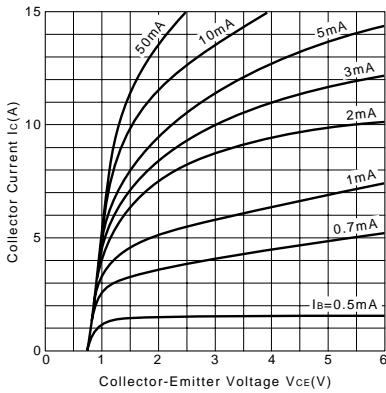

V_{CE(sat)}-I_B Characteristics (Typical)

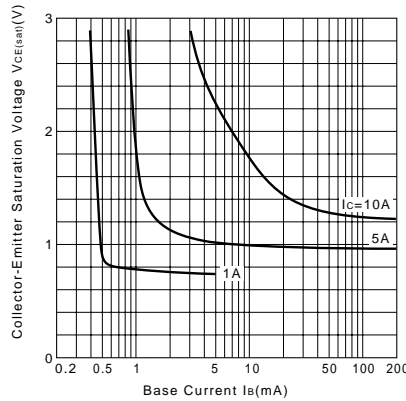

I_C-V_{BE} Temperature Characteristics (Typical)

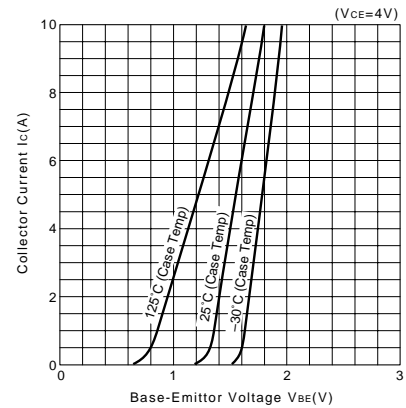

h_{FE}-I_C Characteristics (Typical)

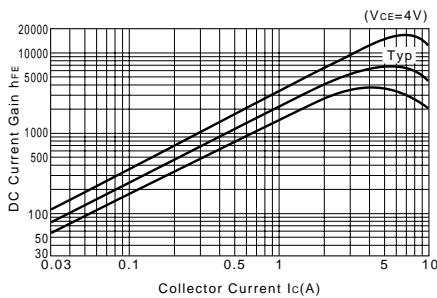

h_{FE}-I_C Temperature Characteristics (Typical)

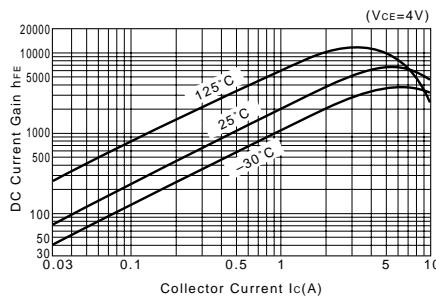

θ_{j-a}-t Characteristics

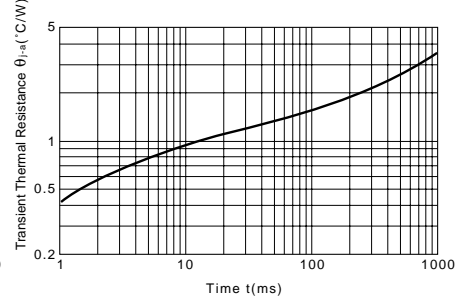

f_T-I_E Characteristics (Typical)

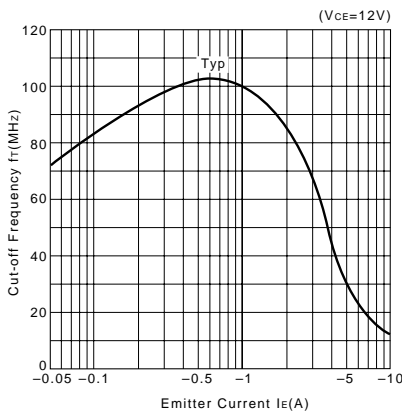

Safe Operating Area (Single Pulse)

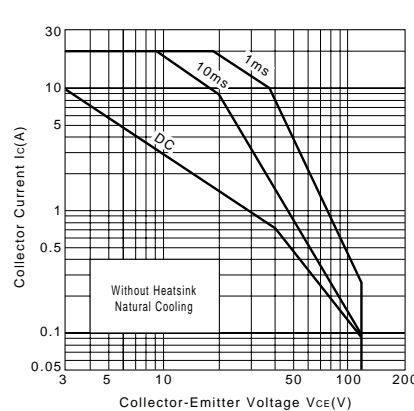

P_C-T_a Derating

