

# PD410PI

## High Speed Photodiode

### ■ Features

1. Peak sensitivity wavelength matching with infrared LED( $\lambda_p = 1000\text{nm}$ )
2. Built-in visible light cut-off filter

### ■ Applications

1. Infrared remote controllers for TVs, VCRs, audio equipment and air conditioners, etc.

### ■ Outline Dimensions

(Unit : mm)

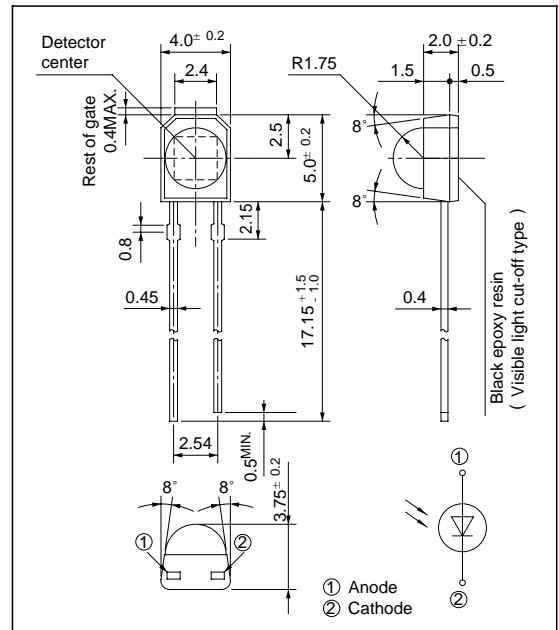

### ■ Absolute Maximum Ratings

(Ta = 25°C)

Parameter	Symbol	Rating	Unit
Reverse voltage	$V_R$	32	V
Power dissipation	P	150	mW
Operating temperature	$T_{opr}$	- 25 to + 85	°C
Storage temperature	$T_{stg}$	- 40 to + 100	°C
*1 Soldering temperature	$T_{sol}$	260	°C

\*1 For 5 seconds at the position of 2.15mm from the bottom face of resin package

### ■ Electro-optical Characteristics

(Ta = 25°C)

Parameter	Symbol	Conditions	MIN.	TYP.	MAX.	Unit
Shortcircuit current	$I_{SC}$	$E_v = 100 \text{ lx}$	2.5	3.0	4.5	$\mu\text{A}$
Short-circuit current temperature coefficient	$\beta_T$	$E_v = 100 \text{ lx}$	-	0.2	-	% / °C
Dark current	$I_d$	$V_R = 10\text{V}, E_v = 0$	-	0.5	10	nA
Dark current temperature coefficient	$\alpha_T$	$V_R = 10\text{V}, E_v = 0$	-	3.5	5.0	times/10°C
Terminal capacitance	$C_t$	$V_R = 3\text{V}, f = 1\text{MHz}$	-	20	35	pF
Peak sensitivity wavelength	$\lambda_p$	-	-	1000	-	nm
Peak spectral sensitivity	K	$\lambda = 1000\text{nm}$	-	1	-	A/W
Half intensity angle	$\Delta\theta$	-	-	$\pm 45$	-	°
Response time	$t_r, t_f$	$R_L = 1\text{k}\Omega, V_R = 10\text{V}$	-	200	-	ns

**Fig. 1 Power Dissipation vs. Ambient Temperature**

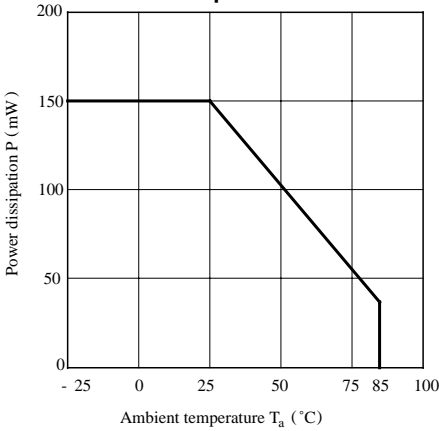

**Fig. 2 Spectral Sensitivity**

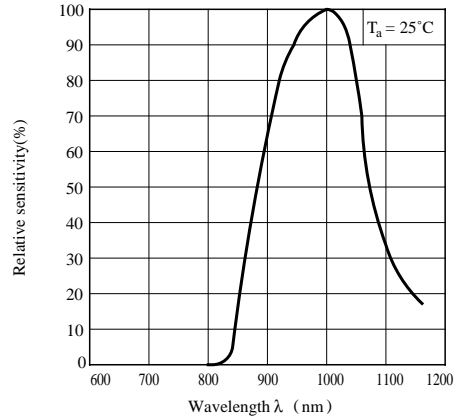

**Fig. 3 Dark Current vs. Ambient Temperature**

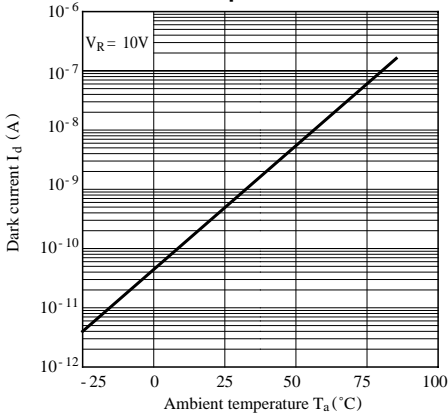

**Fig. 4 Dark Current vs. Reverse Voltage**

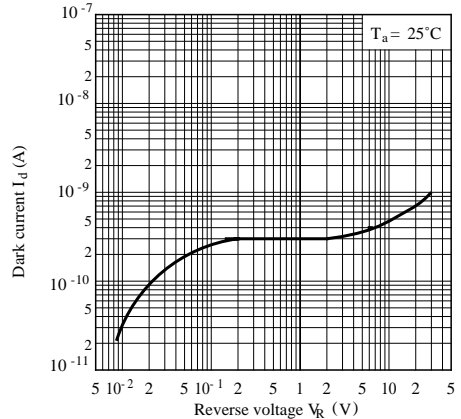

**Fig. 5 Terminal Capacitance vs. Reverse Voltage**

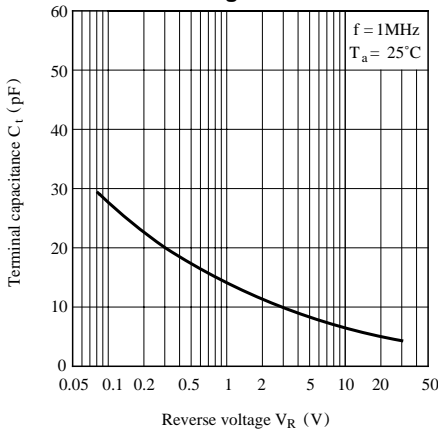

**Fig. 6 Relative Output vs. Ambient Temperature**  
(Emitter : GL537/GL538)  
Detector: PD410PI

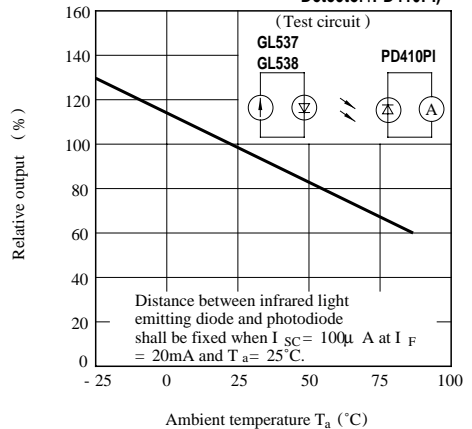

Fig. 7 Sensitivity Diagram ( $T_a = 25^\circ\text{C}$ )

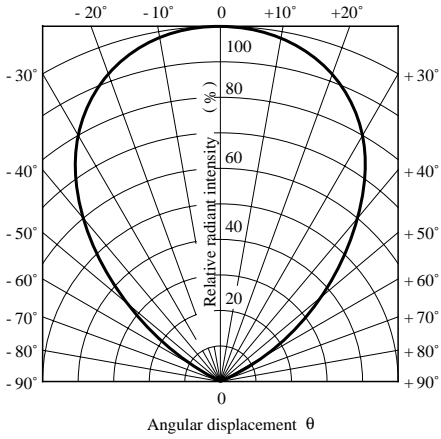

Fig. 8 Relative Output vs. Distance  
(Emitter: GL537/ GL538, Detector: PD410PI)

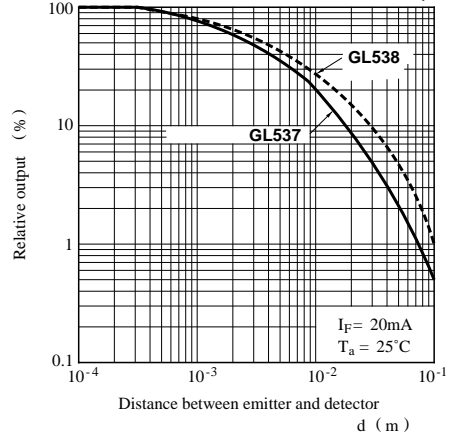
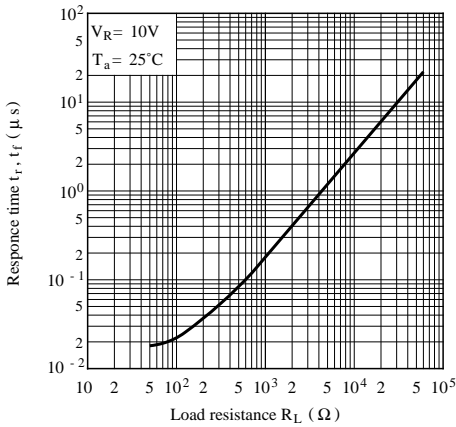
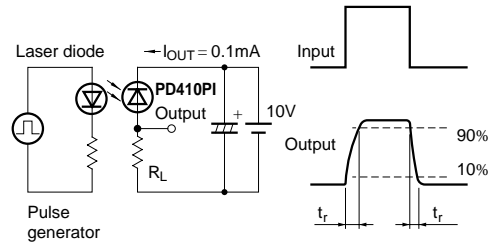

Fig. 9 Response Time vs. Load Resistance



Test Circuit for Response Time



● Please refer to the chapter “Precautions for Use.”