

TOSHIBA PHOTOCOUPLER GaAs IRED & PHOTO-TRANSISTOR

TLP281, TLP281-4

PROGRAMMABLE CONTROLLERS

AC/DC-INPUT MODULE

PC CARD MODEM(PCMCIA)

TLP281 and TLP281-4 is a very small and thin coupler, suitable for surface mount assembly in applications such as PCMCIA Fax modem, programmable controllers.

TLP281 and TLP281-4 consist of photo transistor, optically coupled to a gallium arsenide infrared emitting diode.

- Collector-Emitter Voltage : 80 V (MIN)
- Current Transfer Ratio : 50% (MIN)
Rank GB : 100% (MIN)
- Isolation Voltage : 2500 Vrms (MIN)
- UL Recognized : UL1577 , File No. E67349
- BSI Approved : BS EN 60065: 2002,
: BS EN 60950-1: 2002
Certificate No. 8143, 8144

Unit in mm

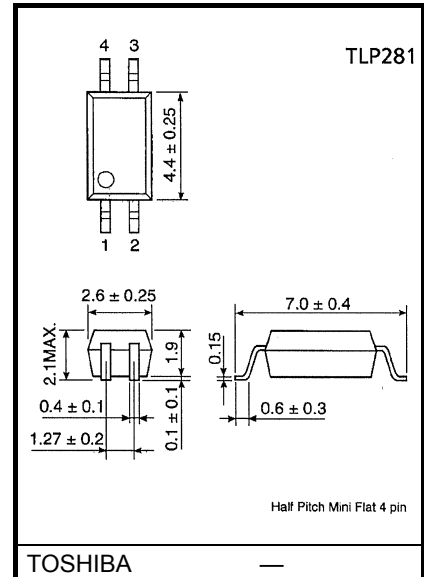

TOSHIBA
Weight: 0.05 g

Pin Configuration (top view)

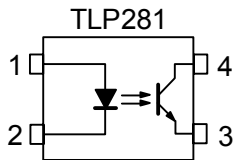

- 1: ANODE
2: CATHODE
3: EMITTER
4: COLLECTOR

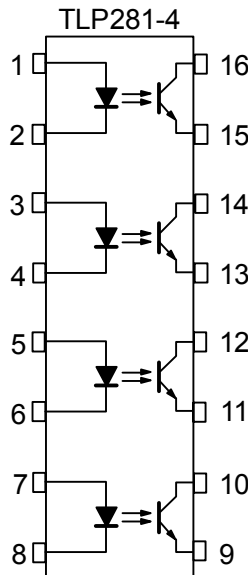

- 1,3,5,7 : ANODE
2,4,6,8 : CATHODE
9,11,13,15 : EMITTER
10,12,14,16 : COLLECTOR

Unit in mm

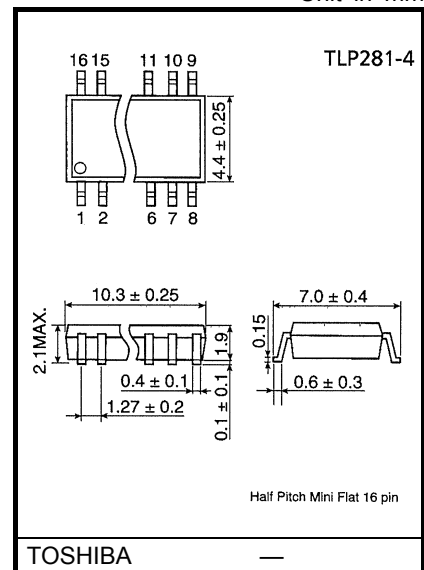

TOSHIBA
Weight: 0.19 g

TYPE	Classi- Fication(*1)	Current Transfer Ratio (%) (I_C / I_F)		Marking of Classification
		$I_F = 5 \text{ mA}, V_{CE} = 5 \text{ V}, T_a = 25^\circ\text{C}$		
		Min	Max	
TLP281	Blank	50	600	Blank, Y [■] , YE, G, G [■] , GR, B, BL, GB
	Rank Y	50	150	YE
	Rank GR	100	300	GR
	Rank BL	200	600	BL
	Rank GB	100	600	GB
	Rank YH	75	150	Y [■]
	Rank GRL	100	200	G
	Rank GRH	150	300	G [■]
	Rank BLL	200	400	B
TLP281-4	Blank	50	600	Blank, GB
	Rank GB	100	600	GB

*1: Ex. rank GB: TLP281 (GB)

(Note): Application type name for certification test, please use standard product type name, i.e.

TLP281 (GB): TLP281-1, TLP281-4 (GB): TLP281-4

Absolute Maximum Ratings (Ta = 25°C)

CHARACTERISTIC		SYMBOL	RATING		UNIT
			TLP281	TLP281-4	
LED	Forward Current	I_F	50		mA
	Forward Current Derating	$\Delta I_F / ^\circ\text{C}$	-0.7 (Ta \geq 53°C)	-0.5 (Ta \geq 25°C)	mA / °C
	Pulse Forward Current	I_{FP}	1		A
	Reverse Voltage	V_R	5		V
	Junction Temperature	T_j	125		°C
DETECTOR	Collector-Emitter Voltage	V_{CEO}	80		V
	Emitter-Collector Voltage	V_{ECO}	7		V
	Collector Current	I_C	50		mA
	Collector Power Dissipation (1 Circuit)	P_C	150	100	mW
	Collector Power Dissipation Derating (Ta \geq 25°C) (1 Circuit)	$\Delta P_C / ^\circ\text{C}$	-1.5	-1.0	mW / °C
	Junction Temperature	T_j	125		°C
Operating Temperature Range		T_{opr}	-55~100		°C
Storage Temperature Range		T_{stg}	-55~125		°C
Lead Soldering Temperature		T_{sol}	260 (10s)		°C
Total Package Power Dissipation (1 Circuit)		P_T	200	170	mW
Total Package Power Dissipation Derating (Ta \geq 25°C) (1 Circuit)		$\Delta P_T / ^\circ\text{C}$	-2.0	-1.7	mW / °C
Isolation Voltage (Note1)		BV_S	2500(AC, 1min, R.H. \leq 60%)		Vrms

Note: Using continuously under heavy loads (e.g. the application of high temperature/current/voltage and the significant change in temperature, etc.) may cause this product to decrease in the reliability significantly even if the operating conditions (i.e. operating temperature/current/voltage, etc.) are within the absolute maximum ratings.

Please design the appropriate reliability upon reviewing the Toshiba Semiconductor Reliability Handbook ("Handling Precautions"/"Derating Concept and Methods") and individual reliability data (i.e. reliability test report and estimated failure rate, etc).

(Note1) Device considered a two terminal device : LED side pins shorted together and DETECTOR side pins shorted together.

Individual Electrical Characteristics (Ta = 25°C)

CHARACTERISTIC		SYMBOL	TEST CONDITION	MIN.	TYP.	MAX.	UNIT
LED	Forward Voltage	V_F	$I_F = 10 \text{ mA}$	1.0	1.15	1.3	V
	Reverse Current	I_R	$V_R = 5 \text{ V}$	—	—	10	μA
	Capacitance	C_T	$V = 0, f = 1 \text{ MHz}$	—	30	—	pF
DETECTOR	Collector-Emitter Breakdown Voltage	$V_{(BR) CEO}$	$I_C = 0.5 \text{ mA}$	80	—	—	V
	Emitter-Collector Breakdown Voltage	$V_{(BR) ECO}$	$I_E = 0.1 \text{ mA}$	7	—	—	V
	Collector Dark Current (Note2)	I_{CEO}	$V_{CE} = 48 \text{ V},$ Ambient Light Below (100 lx)	—	0.01 (2)	0.1 (10)	μA
			$V_{CE} = 48 \text{ V}, T_a = 85^\circ\text{C}$ Ambient Light Below (100 lx)	—	2 (4)	50 (50)	μA
Capacitance (Collector to Emitter)	C_{CE}	$V = 0, f = 1 \text{ MHz}$	—	10	—	pF	

(Note 2) Because of the construction, leak current might be increased by ambient light. Please use photocoupler with less ambient light.

Coupled Electrical Characteristics (Ta = 25°C)

CHARACTERISTIC	SYMBOL	TEST CONDITION	MIN.	TYP.	MAX.	UNIT
Current Transfer Ratio	I_C / I_F	$I_F = 5 \text{ mA}, V_{CE} = 5 \text{ V}$ Rank GB	50	—	600	%
			100	—	600	
Saturated CTR	$I_C / I_F (\text{sat})$	$I_F = 1 \text{ mA}, V_{CE} = 0.4 \text{ V}$ Rank GB	—	60	—	%
			30	—	—	
Collector-Emitter Saturation Voltage	$V_{CE} (\text{sat})$	$I_C = 2.4 \text{ mA}, I_F = 8 \text{ mA}$ $I_C = 0.2 \text{ mA}, I_F = 1 \text{ mA}$ Rank GB	—	—	0.4	V
			—	0.2	—	
Off-State Collector Current	$I_C (\text{off})$	$V_F = 0.7 \text{ V}, V_{CE} = 48 \text{ V}$	—	—	10	μA

Isolation Characteristics (Ta = 25°C)

CHARACTERISTIC	SYMBOL	TEST CONDITION	MIN.	TYP.	MAX.	UNIT
Capacitance (Input to Output)	C_S	$V_S = 0 \text{ V}, f = 1 \text{ MHz}$	—	0.8	—	pF
Isolation Resistance	R_S	$V_S = 500 \text{ V}, \text{R.H.} \leq 60\%$	5×10^{10}	10^{14}	—	Ω
Isolation Voltage	BV_S	AC, 1 minute	2500	—	—	Vrms
		AC, 1 second, in OIL	—	5000	—	Vdc
		DC, 1 minute, in OIL	—	5000	—	

Switching Characteristics (Ta = 25°C)

CHARACTERISTIC	SYMBOL	TEST CONDITION	MIN.	TYP.	MAX.	UNIT
Rise Time	t_r	$V_{CC} = 10 \text{ V}, I_C = 2 \text{ mA}$ $R_L = 100 \Omega$	—	2	—	μs
Fall Time	t_f		—	3	—	
Turn-On Time	t_{on}		—	3	—	
Turn-Off Time	t_{off}		—	3	—	
Turn-On Time	t_{ON}	$R_L = 1.9 \text{ k}\Omega$ (Fig.1) $V_{CC} = 5 \text{ V}, I_F = 16 \text{ mA}$	—	2	—	μs
Storage Time	t_s		—	25	—	
Turn-Off Time	t_{OFF}		—	40	—	

(Fig.1) SWITCHING TIME TEST CIRCUIT

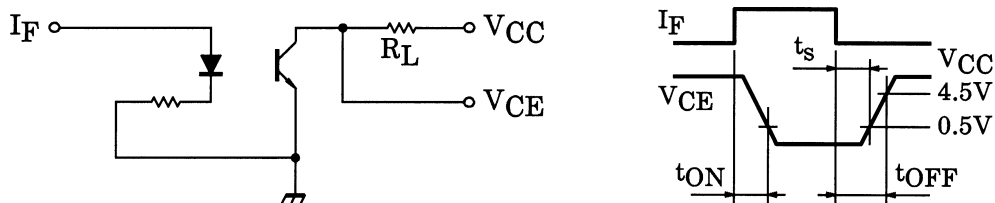

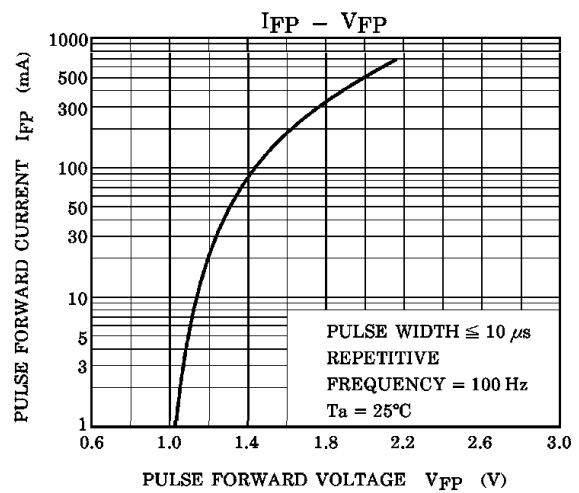
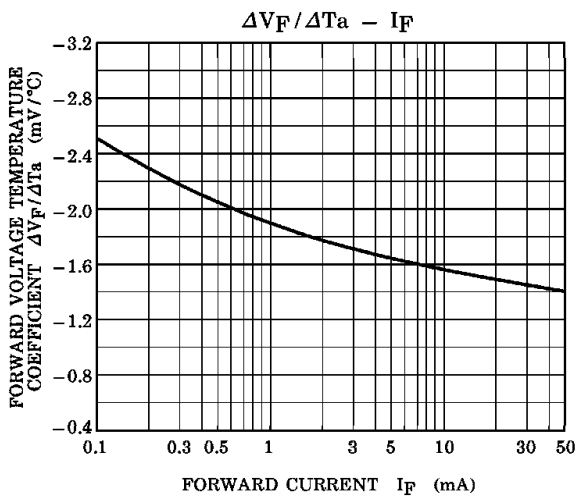
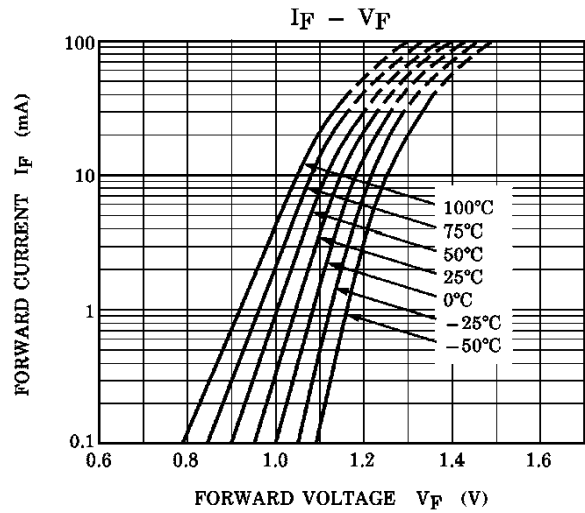
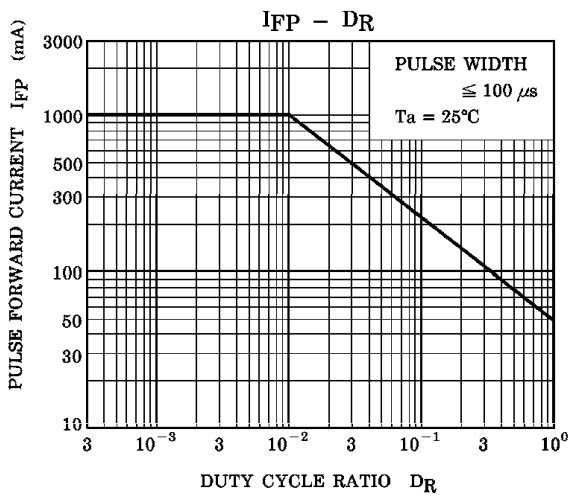
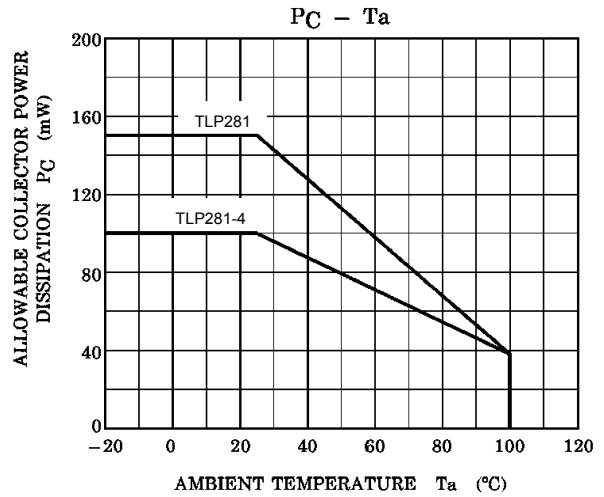
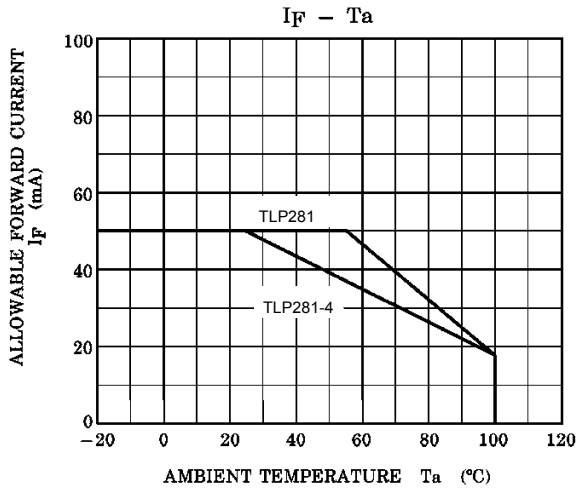

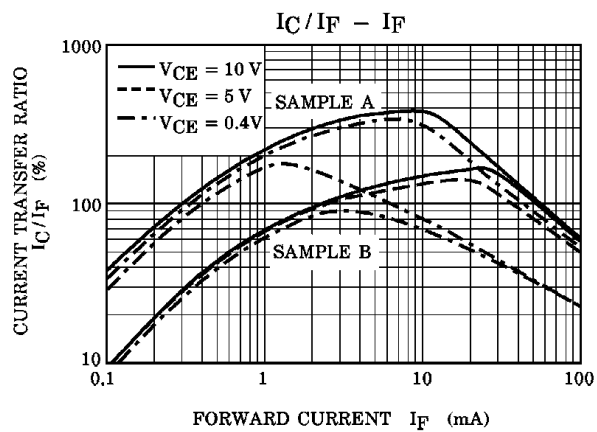
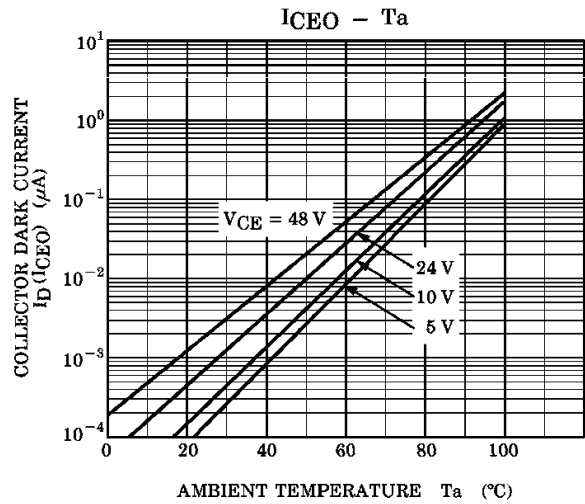
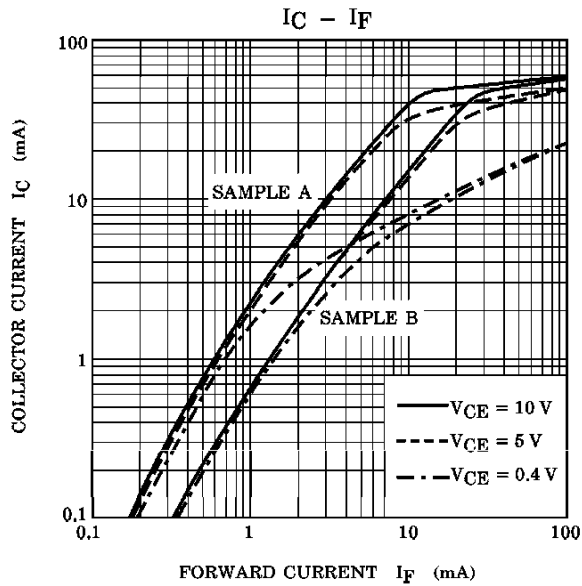
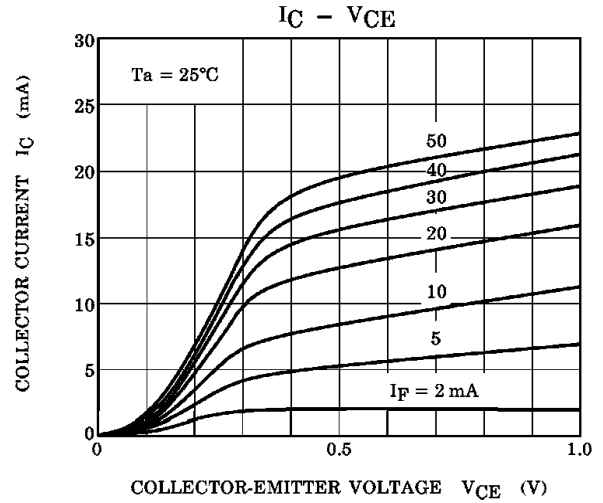
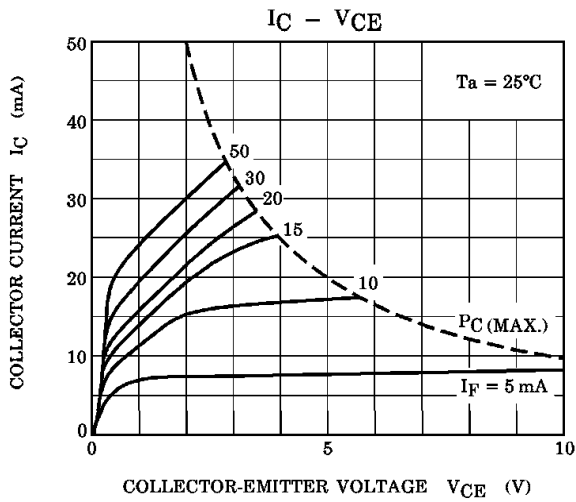

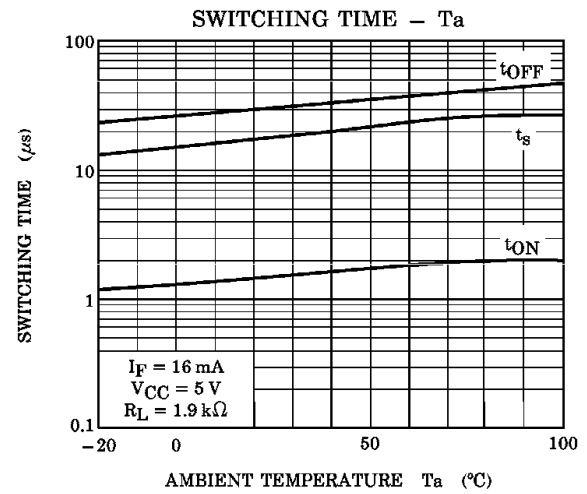
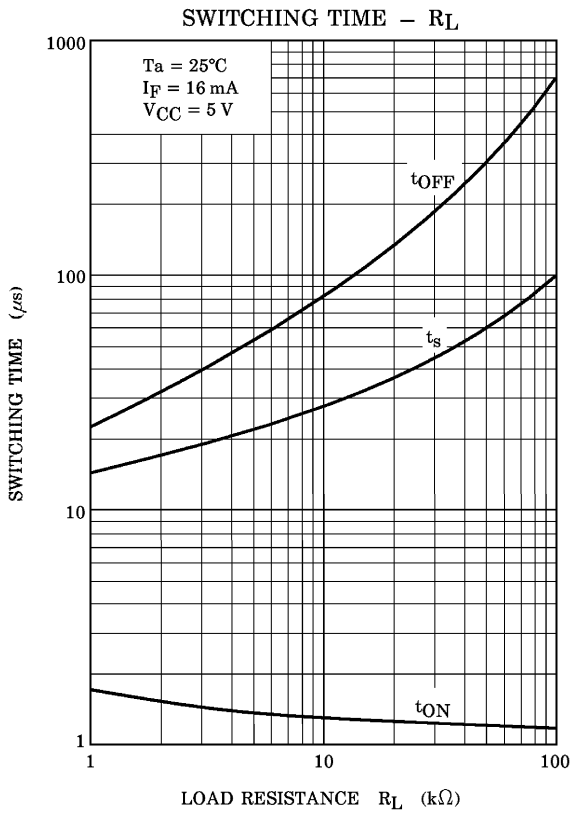
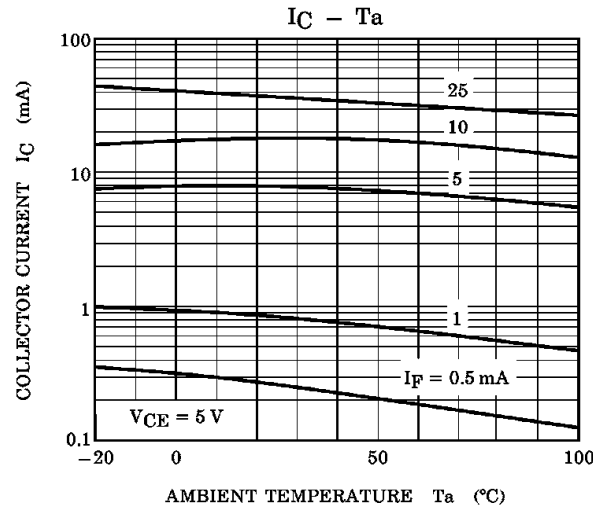
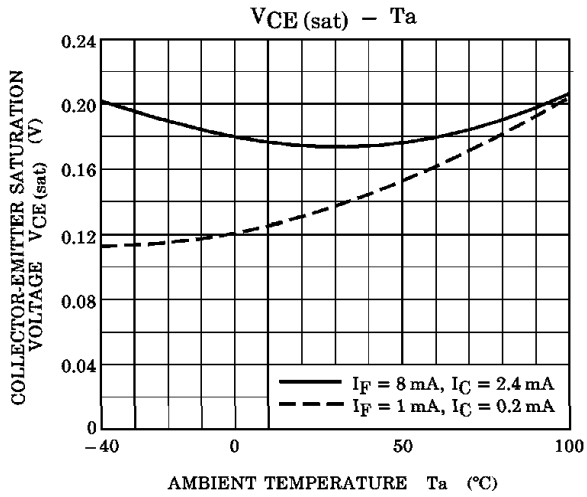

RESTRICTIONS ON PRODUCT USE

20070701-EN

- The information contained herein is subject to change without notice.
- TOSHIBA is continually working to improve the quality and reliability of its products. Nevertheless, semiconductor devices in general can malfunction or fail due to their inherent electrical sensitivity and vulnerability to physical stress. It is the responsibility of the buyer, when utilizing TOSHIBA products, to comply with the standards of safety in making a safe design for the entire system, and to avoid situations in which a malfunction or failure of such TOSHIBA products could cause loss of human life, bodily injury or damage to property.
In developing your designs, please ensure that TOSHIBA products are used within specified operating ranges as set forth in the most recent TOSHIBA products specifications. Also, please keep in mind the precautions and conditions set forth in the "Handling Guide for Semiconductor Devices," or "TOSHIBA Semiconductor Reliability Handbook" etc.
- The TOSHIBA products listed in this document are intended for usage in general electronics applications (computer, personal equipment, office equipment, measuring equipment, industrial robotics, domestic appliances, etc.). These TOSHIBA products are neither intended nor warranted for usage in equipment that requires extraordinarily high quality and/or reliability or a malfunction or failure of which may cause loss of human life or bodily injury ("Unintended Usage"). Unintended Usage include atomic energy control instruments, airplane or spaceship instruments, transportation instruments, traffic signal instruments, combustion control instruments, medical instruments, all types of safety devices, etc.. Unintended Usage of TOSHIBA products listed in this document shall be made at the customer's own risk.
- The products described in this document shall not be used or embedded to any downstream products of which manufacture, use and/or sale are prohibited under any applicable laws and regulations.
- The information contained herein is presented only as a guide for the applications of our products. No responsibility is assumed by TOSHIBA for any infringements of patents or other rights of the third parties which may result from its use. No license is granted by implication or otherwise under any patents or other rights of TOSHIBA or the third parties.
- GaAs(Gallium Arsenide) is used in this product. The dust or vapor is harmful to the human body. Do not break, cut, crush or dissolve chemically.
- Please contact your sales representative for product-by-product details in this document regarding RoHS compatibility. Please use these products in this document in compliance with all applicable laws and regulations that regulate the inclusion or use of controlled substances. Toshiba assumes no liability for damage or losses occurring as a result of noncompliance with applicable laws and regulations.