

TC4S584F

SCHMITT TRIGGER

TC4S584F is the one circuit inverter having the schmitt trigger function at the input terminal.

That is, since the circuit threshold level voltage at the leading and trailing edges of input waveform are different (V_P , V_N), the TC4S584F can be used in the broad range application, including line receiver, waveform shaping circuit, astable multivibrator, etc. In addition to ordinary inverter.

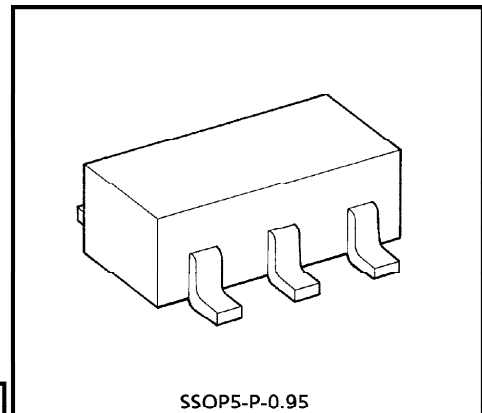

Weight : 0.016g (Typ.)

MAXIMUM RATINGS

CHARACTERISTIC	SYMBOL	RATING	UNIT
DC Supply Voltage	V_{DD}	$V_{SS} - 0.5 \sim V_{SS} + 20$	V
Input Voltage	V_{IN}	$V_{SS} - 0.5 \sim V_{DD} + 0.5$	V
Output Voltage	V_{OUT}	$V_{SS} - 0.5 \sim V_{DD} + 0.5$	V
DC Input Current	I_{IN}	± 10	mA
Power Dissipation	P_D	200	mW
Operating Temperature Range	T_{opr}	-40~85	°C
Storage Temperature Range	T_{stg}	-65~150	°C
Lead Temperature (10s)	T_L	260	°C

LOGIC DIAGRAM

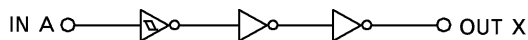

PIN ASSIGNMENT (TOP VIEW)

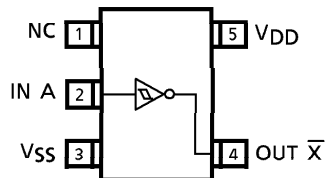

MARKING

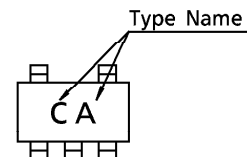

961001EBA2

● TOSHIBA is continually working to improve the quality and the reliability of its products. Nevertheless, semiconductor devices in general can malfunction or fail due to their inherent electrical sensitivity and vulnerability to physical stress. It is the responsibility of the buyer, when utilizing TOSHIBA products, to observe standards of safety, and to avoid situations in which a malfunction or failure of a TOSHIBA product could cause loss of human life, bodily injury or damage to property. In developing your designs, please ensure that TOSHIBA products are used within specified operating ranges as set forth in the most recent products specifications. Also, please keep in mind the precautions and conditions set forth in the TOSHIBA Semiconductor Reliability Handbook.

RECOMMENDED OPERATING CONDITIONS ($V_{SS} = 0V$)

CHARACTERISTIC	SYMBOL		MIN.	TYP.	MAX.	UNIT
DC Supply Voltage	V_{DD}	—	3	—	18	V
Input Voltage	V_{IN}	—	0	—	V_{DD}	V

STATIC ELECTRICAL CHARACTERISTICS ($V_{SS} = 0V$)

CHARACTERISTIC	SYM-BOL	TEST CONDITION	V_{DD} (V)	-40°C		25°C			85°C		UNIT	
				MIN.	MAX.	MIN.	TYP.	MAX.	MIN.	MAX.		
High-Level Output Voltage	V_{OH}	$ I_{OUT} < 1\mu A$ $V_{IN} = V_{SS}, V_{DD}$	5	4.95	—	4.95	5.00	—	4.95	—	V	
			10	9.95	—	9.95	10.00	—	9.95	—		
			15	14.95	—	14.95	15.00	—	14.95	—		
Low-Level Output Voltage	V_{OL}	$ I_{OUT} < 1\mu A$ $V_{IN} = V_{SS}, V_{DD}$	5	—	0.05	—	0.00	0.05	—	0.05	V	
			10	—	0.05	—	0.00	0.05	—	0.05		
			15	—	0.05	—	0.00	0.05	—	0.05		
Output High Current	I_{OH}	$V_{OH} = 4.6V$ $V_{OH} = 2.5V$ $V_{OH} = 9.5V$ $V_{OH} = 13.5V$ $V_{IN} = V_{SS}, V_{DD}$	5	-0.61	—	-0.51	-1.0	—	-0.42	—	mA	
			5	-2.5	—	-2.1	-4.0	—	-1.7	—		
			10	-1.5	—	-1.3	-2.2	—	-1.1	—		
			15	-4.0	—	-3.4	-9.0	—	-2.8	—		
Output Low Current	I_{OL}	$V_{OL} = 0.4V$ $V_{OL} = 0.5V$ $V_{OL} = 1.5V$ $V_{IN} = V_{SS}, V_{DD}$	5	0.61	—	0.51	1.5	—	0.42	—	mA	
			10	1.5	—	1.3	3.8	—	1.1	—		
			15	4.0	—	3.4	15.0	—	2.8	—		
			15	4.0	—	3.4	15.0	—	2.8	—		
Positive Trigger Threshold Voltage*	V_P	$V_{OUT} = 0.5V$ $V_{OUT} = 1.0V$ $V_{OUT} = 1.5V$	5	1.95	3.65	2.05	2.9	3.35	2.05	3.75	V	
			10	4.3	7.1	4.5	5.9	7.1	4.7	7.2		
			15	6.9	10.7	7.1	9.0	10.6	7.1	10.8		
Negative Trigger Threshold Voltage*	V_N	$V_{OUT} = 4.5V$ $V_{OUT} = 9.0V$ $V_{OUT} = 13.5V$	5	1.05	2.75	1.1	2.1	2.6	0.95	2.65	V	
			10	2.1	4.9	2.2	3.5	4.7	2.0	4.8		
			15	3.2	7.0	3.3	5.0	6.8	3.1	6.9		
Hysteresis Voltage*	V_H	—	5	0.1	1.35	0.4	0.75	1.3	0.4	1.50	V	
			10	1.7	3.2	1.8	2.4	3.2	1.7	3.4		
			15	3.1	4.8	3.2	4.0	4.8	3.2	4.9		
Input Current	H Level	I_{IH}	$V_{IH} = 18V$	18	—	0.1	—	10^{-5}	0.1	—	1.0	μA
	L Level	I_{IL}	$V_{IL} = 0V$	18	—	-0.1	—	-10^{-5}	-0.1	—	-1.0	
Quiescent Device Current	I_{DD}	$V_{IN} = V_{SS}, V_{DD}$	5	—	1	—	0.001	1	—	7.5	μA	
			10	—	2	—	0.002	2	—	15		
			15	—	4	—	0.004	4	—	30		

(Note) Values are different to TC4584BP, TC4584BF marked* (V_P, V_N, V_H).

961001EBA2'

- The products described in this document are subject to foreign exchange and foreign trade control laws.
- The information contained herein is presented only as a guide for the applications of our products. No responsibility is assumed by TOSHIBA CORPORATION for any infringements of intellectual property or other rights of the third parties which may result from its use. No license is granted by implication or otherwise under any intellectual property or other rights of TOSHIBA CORPORATION or others.
- The information contained herein is subject to change without notice.

DYNAMIC ELECTRICAL CHARACTERISTICS (Ta = 25°C, VSS = 0V, CL = 50pF)

CHARACTERISTIC	SYMBOL	TEST CONDITION	VDD (V)	MIN.	TYP.	MAX.	UNIT
Output Transition Time (Low to High)	tTLH	—	5	—	80	200	ns
			10	—	50	100	
			15	—	40	80	
Output Transition Time (High to Low)	tTHL	—	5	—	80	200	ns
			10	—	50	100	
			15	—	40	80	
Propagation Delay Time	t _{pLH} t _{pHL}	—	5	—	170	340	ns
			10	—	80	160	
			15	—	60	120	
Input Capacitance	CIN	—	—	5	7.5	pF	

CIRCUIT AND WAVEFORM FOR MEASUREMENT OF DYNAMIC CHARACTERISTICS

CIRCUIT

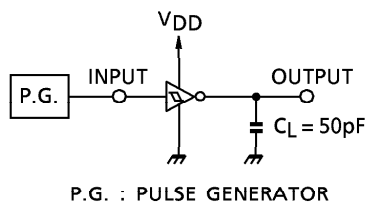

WAVEFORM

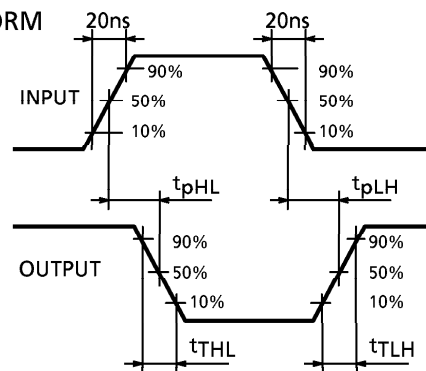

INPUT-OUTPUT VOLTAGE CHARACTERISTICS

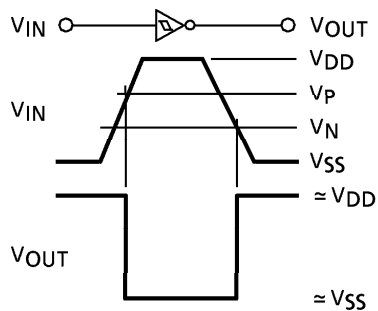

● INPUT-OUTPUT VOLTAGE WAVEFORM

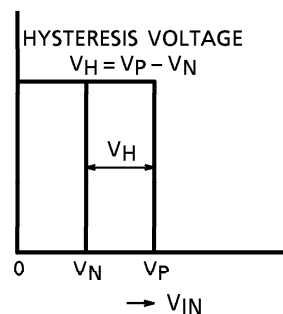

● TRANSFER CHARACTERISTICS

OUTLINE DRAWING
SSOP5-P-0.95

Unit : mm



Weight : 0.016g (Typ.)