

FDC6320C Dual N & P Channel , Digital FET

General Description

These dual N & P Channel logic level enhancement mode field effect transistors are produced using Fairchild's proprietary, high cell density, DMOS technology. This very high density process is especially tailored to minimize on-state resistance. The device is an improved design especially for low voltage applications as a replacement for bipolar digital transistors in load switching applications. Since bias resistors are not required, this dual digital FET can replace several digital transistors with difference bias resistors.

Features

- N-Ch 25 V, 0.22 A, $R_{DS(ON)} = 5 \Omega @ V_{GS} = 2.7 V$.
- P-Ch 25 V, -0.12 A, $R_{DS(ON)} = 13 \Omega @ V_{GS} = -2.7 V$.
- Very low level gate drive requirements allowing direct operation in 3 V circuits. $V_{GS(th)} < 1.5 V$.
- Gate-Source Zener for ESD ruggedness. >6kV Human Body Model
- Replace NPN & PNP digital transistors.

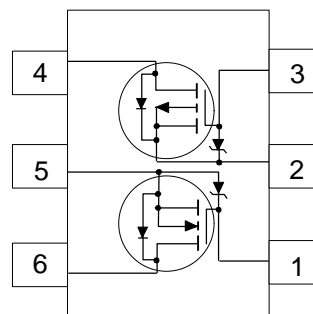
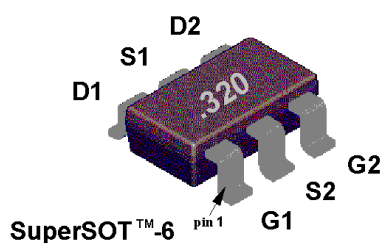

Absolute Maximum Ratings $T_A = 25^\circ\text{C}$ unless other wise noted

| Symbol | Parameter | N-Channel | P-Channel | Units |
|-------------------|---|------------|-----------|------------------|
| V_{DSS}, V_{CC} | Drain-Source Voltage, Power Supply Voltage | 25 | -25 | V |
| V_{GSS}, V_{IN} | Gate-Source Voltage, | 8 | -8 | V |
| I_D, I_O | Drain/Output Current - Continuous | 0.22 | -0.12 | A |
| | - Pulsed | 0.5 | -0.5 | |
| P_D | Maximum Power Dissipation (Note 1a) (Note 1b) | 0.9 | | W |
| | | 0.7 | | |
| T_J, T_{STG} | Operating and Storage Temperature Ranager | -55 to 150 | | $^\circ\text{C}$ |
| ESD | Electrostatic Discharge Rating MIL-STD-883D Human Body Model (100pf / 1500 Ohm) | 6 | | kV |

THERMAL CHARACTERISTICS

| | | | |
|-----------------|---|-----|--------------------|
| $R_{\theta JA}$ | Thermal Resistance, Junction-to-Ambient (Note 1a) | 140 | $^\circ\text{C/W}$ |
| $R_{\theta JC}$ | Thermal Resistance, Junction-to-Case (Note 1) | 60 | $^\circ\text{C/W}$ |

DMOS Electrical Characteristics ($T_A = 25\text{ }^\circ\text{C}$ unless otherwise noted)

| Symbol | Parameter | Conditions | Type | Min | Typ | Max | Units |
|------------------------------------|--|---|------|-------|-------|-----------|----------------------------|
| OFF CHARACTERISTICS | | | | | | | |
| BV_{DSS} | Drain-Source Breakdown Voltage | $V_{GS} = 0\text{ V}, I_D = 250\text{ }\mu\text{A}$ | N-Ch | 25 | | | V |
| | | $V_{GS} = 0\text{ V}, I_D = -250\text{ }\mu\text{A}$ | P-Ch | -25 | | | |
| $\Delta BV_{DSS}/\Delta T_J$ | Breakdown Voltage Temp. Coefficient | $I_D = 250\text{ }\mu\text{A}$, Referenced to $25\text{ }^\circ\text{C}$ | N-Ch | | 25 | | $\text{mV}/^\circ\text{C}$ |
| | | $I_D = -250\text{ }\mu\text{A}$, Referenced to $25\text{ }^\circ\text{C}$ | P-Ch | | -20 | | |
| I_{DSS} | Zero Gate Voltage Drain Current | $V_{DS} = 20\text{ V}, V_{GS} = 0\text{ V}$, $T_J = 55\text{ }^\circ\text{C}$ | N-Ch | | | 1 10 | μA |
| | | $V_{DS} = -20\text{ V}, V_{GS} = 0\text{ V}$, $T_J = 55\text{ }^\circ\text{C}$ | P-Ch | | | -1 -10 | |
| I_{GSS} | Gate - Body Leakage Current | $V_{GS} = 8\text{ V}, V_{DS} = 0\text{ V}$ | N-Ch | | | 100 | nA |
| | | $V_{GS} = -8\text{ V}, V_{DS} = 0\text{ V}$ | P-Ch | | | -100 | nA |
| ON CHARACTERISTICS (Note 2) | | | | | | | |
| $\Delta V_{GS(th)}/\Delta T_J$ | Gate Threshold Voltage Temp. Coefficient | $I_D = 250\text{ }\mu\text{A}$, Referenced to $25\text{ }^\circ\text{C}$ | N-Ch | | -2.1 | | $\text{mV}/^\circ\text{C}$ |
| | | $I_D = -250\text{ }\mu\text{A}$, Referenced to $25\text{ }^\circ\text{C}$ | P-Ch | | 1.9 | | |
| $V_{GS(th)}$ | Gate Threshold Voltage | $V_{DS} = V_{GS}, I_D = 250\text{ }\mu\text{A}$ | N-Ch | 0.65 | 0.85 | 1.5 | V |
| | | $V_{DS} = V_{GS}, I_D = -250\text{ }\mu\text{A}$ | P-Ch | -0.65 | -1 | -1.5 | |
| $R_{DS(on)}$ | Static Drain-Source On-Resistance | $V_{GS} = 2.7\text{ V}, I_D = 0.2\text{ A}$, $T_J = 125\text{ }^\circ\text{C}$ | N-Ch | | 3.8 | 5 | Ω |
| | | $V_{GS} = 4.5\text{ V}, I_D = 0.4\text{ A}$ | | | 6.3 | 9 | |
| | | $V_{GS} = -2.7\text{ V}, I_D = -0.05\text{ A}$, $T_J = 125\text{ }^\circ\text{C}$ | P-Ch | | 10.6 | 13 | |
| | | $V_{GS} = -4.5\text{ V}, I_D = -0.2\text{ A}$ | | | 15 | 21 | |
| | | | | | 7.9 | 10 | |
| $I_{D(on)}$ | On-State Drain Current | $V_{GS} = 2.7\text{ V}, V_{DS} = 5\text{ V}$ | N-Ch | 0.2 | | | A |
| | | $V_{GS} = -2.7\text{ V}, V_{DS} = -5\text{ V}$ | P-Ch | -0.05 | | | |
| g_{FS} | Forward Transconductance | $V_{DS} = 5\text{ V}, I_D = 0.4\text{ A}$ | N-Ch | | 0.2 | | S |
| | | $V_{DS} = -5\text{ V}, I_D = -0.2\text{ A}$ | P-Ch | | 0.135 | | |
| DYNAMIC CHARACTERISTICS | | | | | | | |
| C_{iss} | Input Capacitance | N-Channel $V_{DS} = 10\text{ V}, V_{GS} = 0\text{ V}$, $f = 1.0\text{ MHz}$ | N-Ch | | 9.5 | | pF |
| | | | P-Ch | | 11 | | |
| C_{oss} | Output Capacitance | P-Channel $V_{DS} = -10\text{ V}, V_{GS} = 0\text{ V}$, $f = 1.0\text{ MHz}$ | N-Ch | | 6 | | pF |
| | | | P-Ch | | 7 | | |
| C_{rss} | Reverse Transfer Capacitance | | N-Ch | | 1.3 | | pF |
| | | | P-Ch | | 1.4 | | |

DMOS Electrical Characteristics ($T_A = 25\text{ }^\circ\text{C}$ unless otherwise noted)

| Symbol | Parameter | Conditions | Type | Min | Typ | Max | Units |
|---|---|---|------|-----|-------|------|-------|
| SWITCHING CHARACTERISTICS (Note 2) | | | | | | | |
| $t_{D(on)}$ | Turn - On Delay Time | N-Channel $V_{DD} = 6\text{ V}, I_D = 0.5\text{ A},$ | N-Ch | | 5 | 11 | nS |
| | | | P-Ch | | 6 | 12 | |
| t_r | Turn - On Rise Time | $V_{GS} = 4.5\text{ V}, R_{GEN} = 50\ \Omega$ | N-Ch | | 4.5 | 10 | nS |
| | | | P-Ch | | 6 | 12 | |
| $t_{D(off)}$ | Turn - Off Delay Time | P-Channel $V_{DD} = -6\text{ V}, I_D = -0.5\text{ A},$ | N-Ch | | 4 | 10 | nS |
| | | | P-Ch | | 7.4 | 15 | |
| t_f | Turn - Off Fall Time | $V_{GEN} = -4.5\text{ V}, R_{GEN} = 50\ \Omega$ | N-Ch | | 3.2 | 8 | nS |
| | | | P-Ch | | 4 | 10 | |
| Q_g | Total Gate Charge | N-Channel $V_{DS} = 5\text{ V},$ $I_D = 0.2\text{ A}, V_{GS} = 4.5\text{ V}$ | N-Ch | | 0.29 | 0.4 | nC |
| | | | P-Ch | | 0.23 | 0.32 | |
| Q_{gs} | Gate-Source Charge | P-Channel $V_{DS} = -5\text{ V},$ $I_D = -0.2\text{ A}, V_{GS} = -4.5\text{ V}$ | N-Ch | | 0.105 | | nC |
| | | | P-Ch | | 0.12 | | |
| Q_{gd} | Gate-Drain Charge | | N-Ch | | 0.045 | | nC |
| | | | P-Ch | | 0.03 | | |
| DRAIN-SOURCE DIODE CHARACTERISTICS AND MAXIMUM RATINGS | | | | | | | |
| I_S | Maximum Continuous Drain-Source Diode Forward Current | | N-Ch | | | 0.5 | A |
| | | | P-Ch | | | -0.5 | |
| V_{SD} | Drain-Source Diode Forward Voltage | $V_{GS} = 0\text{ V}, I_S = 0.5\text{ A}$ (Note 2) | N-Ch | | 0.97 | 1.3 | V |
| | | $V_{GS} = 0\text{ V}, I_S = -0.5\text{ A}$ (Note 2) | P-Ch | | -1 | -1.3 | |

Notes:

- $R_{\theta JA}$ is the sum of the junction-to-case and case-to-ambient thermal resistance where the case thermal reference is defined as the solder mounting surface of the drain pins. $R_{\theta JC}$ is guaranteed by design while $R_{\theta CA}$ is determined by the user's board design.

Typical $R_{\theta JA}$ using the board layouts shown below on FR-4 PCB in a still air environment:

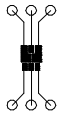

a. $140\text{ }^\circ\text{C/W}$ on a 0.125 in^2 pad of 2oz copper.

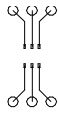

b. $180\text{ }^\circ\text{C/W}$ on a 0.005 in^2 pad of 2oz copper.

Scale 1 : 1 on letter size paper

- Pulse Test: Pulse Width $\leq 300\ \mu\text{s}$, Duty Cycle $\leq 2.0\%$.

Typical Electrical Characteristics: N-Channel

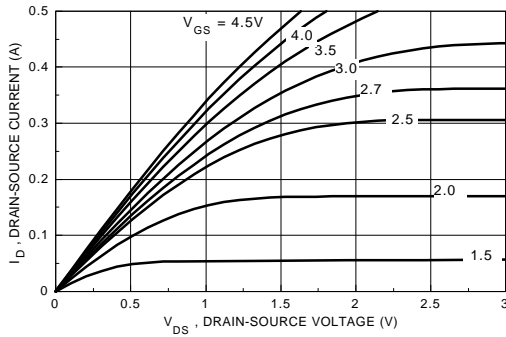

Figure 1. On-Region Characteristics.

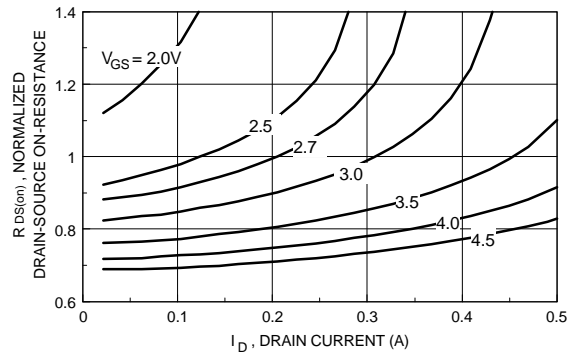

Figure 2. On-Resistance Variation with Drain Current and Gate Voltage.

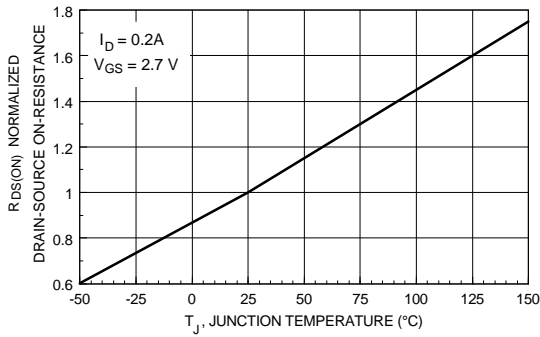

Figure 3. On-Resistance Variation with Temperature.

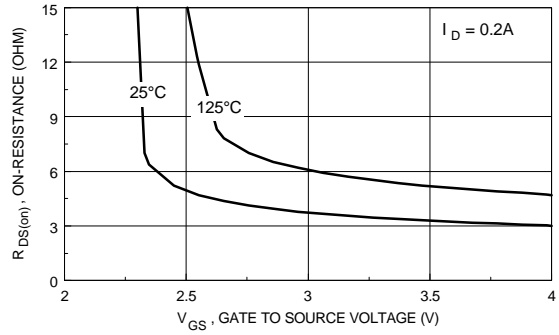

Figure 4. On-Resistance Variation with Gate-To-Source Voltage.

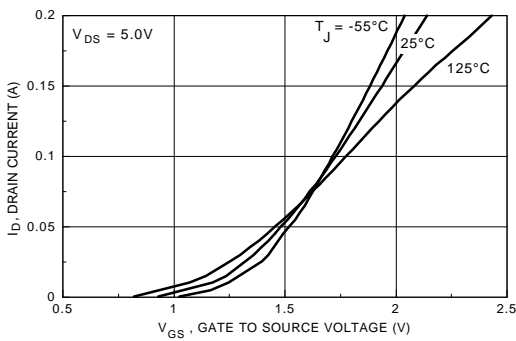

Figure 5. Transfer Characteristics.

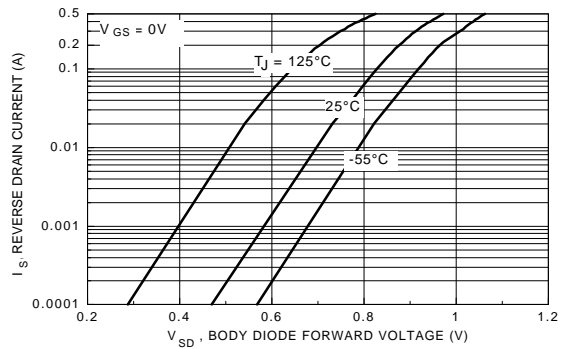

Figure 6. Body Diode Forward Voltage Variation with Source Current and Temperature.

Typical Electrical Characteristics: N-Channel (continued)

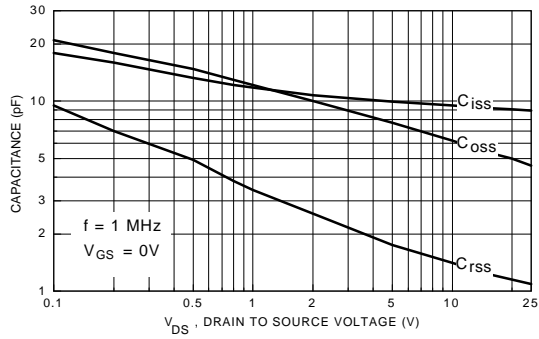

Figure 7. Capacitance Characteristics.

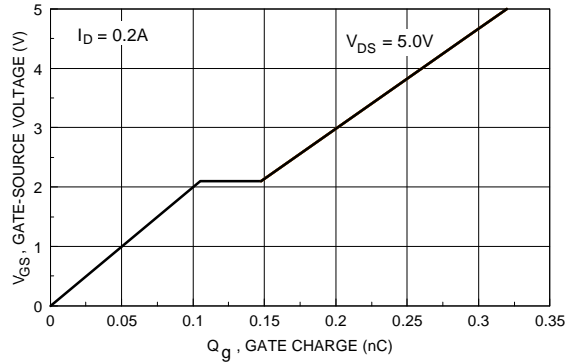

Figure 8. Gate Charge Characteristics.

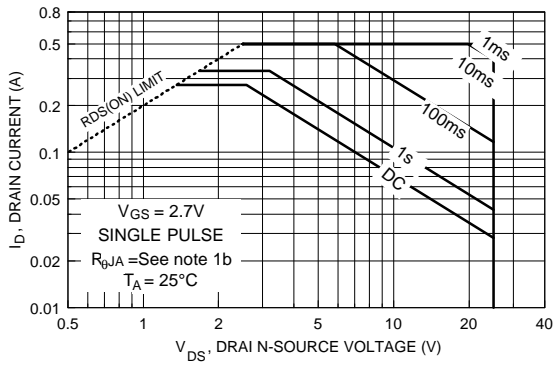

Figure 9. Maximum Safe Operating Area.

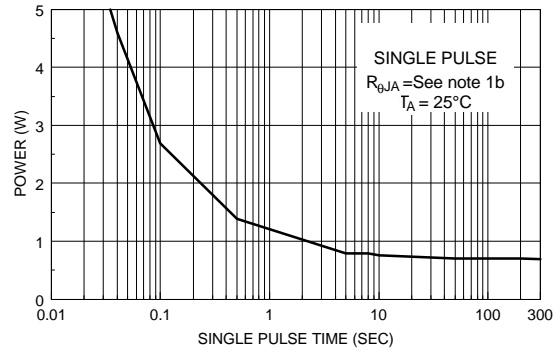

Figure 10. Single Pulse Maximum Power Dissipation.

Typical Electrical Characteristics: P-Channel

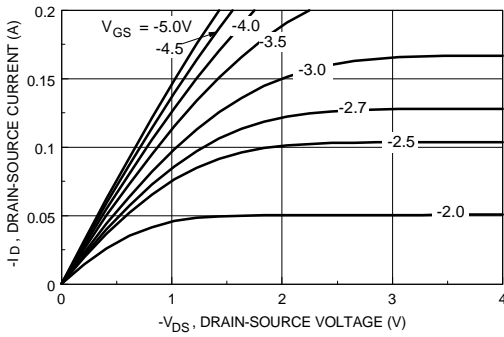

Figure 11. On-Region Characteristics.

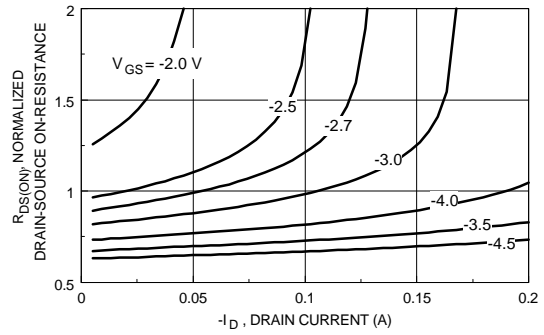

Figure 12. On-Resistance Variation with Drain Current and Gate Voltage.

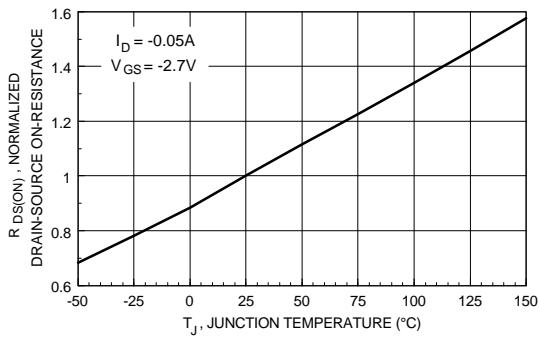

Figure 13. On-Resistance Variation with Temperature.

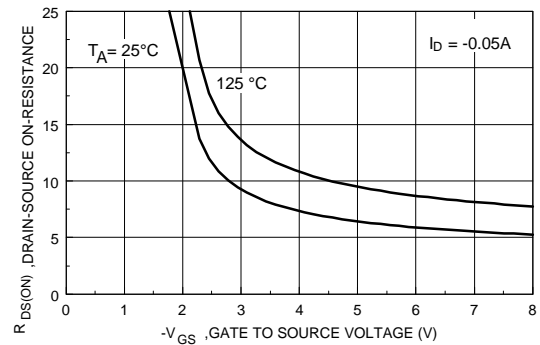

Figure 14. On Resistance Variation with Gate-To- Source Voltage.

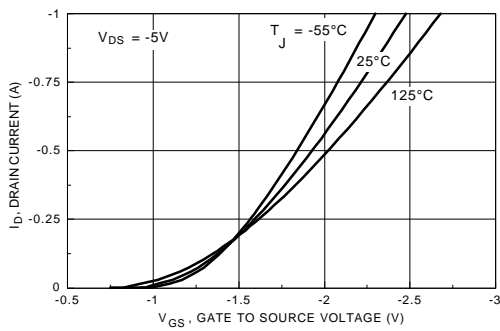

Figure 15. Transfer Characteristics.

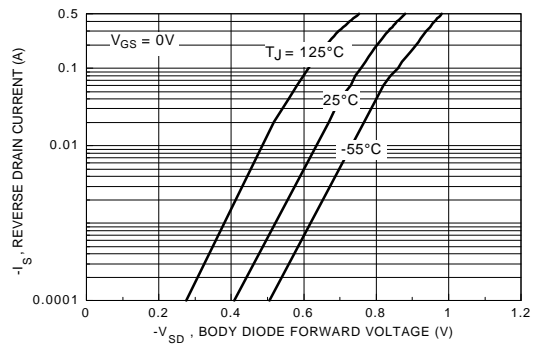

Figure 16. Body Diode Forward Voltage Variation with Source Current and Temperature.

Typical Electrical Characteristics: P-Channel (continued)

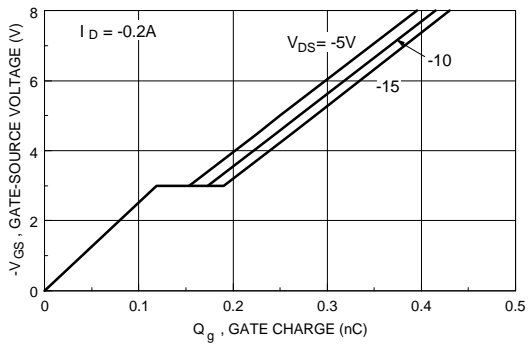

Figure 17. Gate Charge Characteristics.

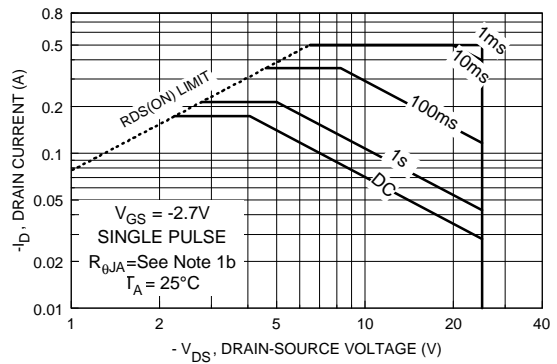

Figure 18. Maximum Safe Operating Area.

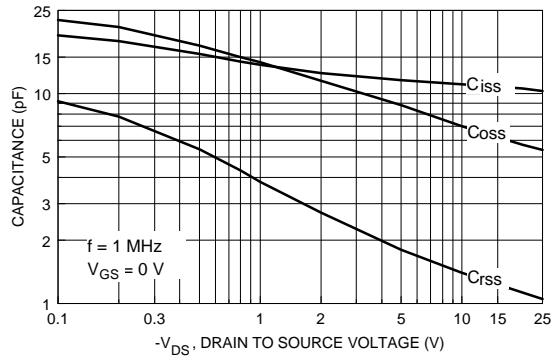

Figure 19. Capacitance Characteristics.

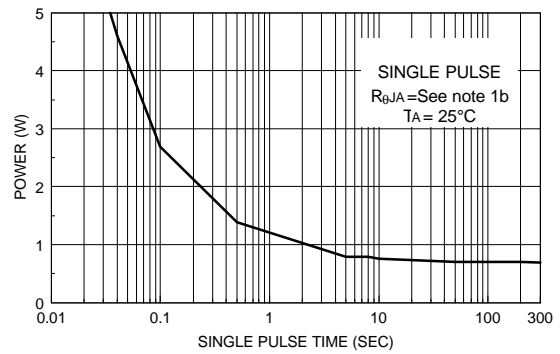

Figure 20. Single Pulse Maximum Power Dissipation.

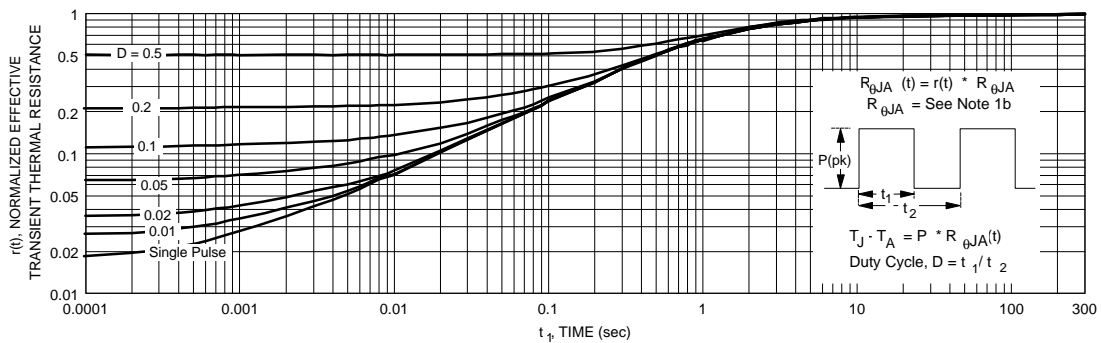

Figure 21. Transient Thermal Response Curve.

Note: Thermal characterization performed using the conditions described in note 1b. Transient thermal response will change depending on the circuit board design.