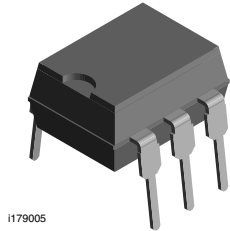
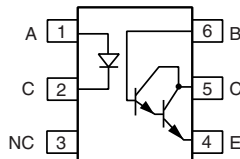




Optocoupler, Photodarlington Output, High Gain, With Base Connection



i179005



i179005_1



DESCRIPTION

The 4N32 and 4N33 are optically coupled isolators with a gallium arsenide infrared LED and a silicon photodarlington sensor.

Switching can be achieved while maintaining a high degree of isolation between driving and load circuits.

These optocouplers can be used to replace reed and mercury relays with advantages of long life, high speed switching and elimination of magnetic fields.

FEATURES

- Very high current transfer ratio, 500 % min.
- High isolation resistance, $10^{11} \Omega$ typical
- Standard plastic DIP package
- Material categorization: for definitions of compliance please see www.vishay.com/doc?99912

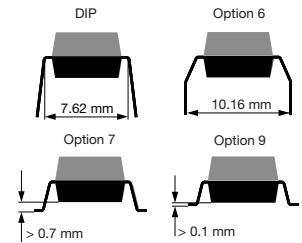
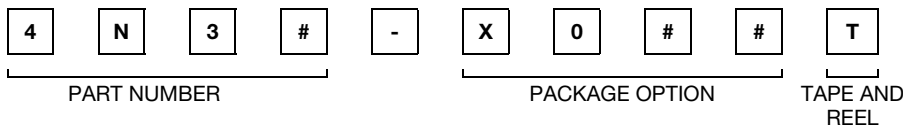


RoHS COMPLIANT

AGENCY APPROVALS

- UL1577, file no. E52744 system code H
- DIN EN 60747-5-2 (VDE 0884) / DIN EN 60747-5-5 (pending), available with option 1
- BSI IEC 60950; IEC 60065
- FIMKO

ORDERING INFORMATION



AGENCY CERTIFIED/PACKAGE	CTR (%)	
	UL, BSI, FIMKO	≥ 500
DIP-6	4N32	4N33
DIP-6, 400 mil, option 6	4N32-X006	-
SMD-6, option 7	4N32-X007T ⁽¹⁾	4N33-X007T ⁽¹⁾
SMD-6, option 9	4N32-X009T ⁽¹⁾	4N33-X009T ⁽¹⁾
VDE, UL, BSI, FIMKO	≥ 500	≥ 500
DIP-6	4N32-X001	4N33-X001
SMD-6, option 7	4N32-X017T	4N33-X017T ⁽¹⁾

Notes

- Additional options may be possible, please contact sales office
- ⁽¹⁾ Also available in tubes, do not put T on the end



ABSOLUTE MAXIMUM RATINGS ($T_{amb} = 25\text{ }^{\circ}\text{C}$, unless otherwise specified)				
PARAMETER	TEST CONDITION	SYMBOL	VALUE	UNIT
INPUT				
Reverse voltage		V_R	3	V
Forward current		I_F	60	mA
Power dissipation		P_{diss}	100	mW
Derate linearly	From 55 $^{\circ}\text{C}$		1.33	mW/ $^{\circ}\text{C}$
OUTPUT				
Collector emitter breakdown voltage		BV_{CEO}	30	V
Emitter base breakdown voltage		BV_{EBO}	8	V
Collector base breakdown voltage		BV_{CBO}	50	V
Emitter collector breakdown voltage		BV_{ECO}	5	V
Collector (load) current		I_C	100	mA
Power dissipation		P_{diss}	150	mW
Derate linearly			2	mW/ $^{\circ}\text{C}$
COUPLER				
Total dissipation		P_{tot}	250	mW
Derate linearly			3.3	mW/ $^{\circ}\text{C}$
Isolation test voltage (between emitter	1 s	V_{ISO}	5300	V_{RMS}
Leakage path			7	mm min.
Air path			7	mm min.
Isolation resistance	$V_{IO} = 500\text{ V}$, $T_{amb} = 25\text{ }^{\circ}\text{C}$	R_{IO}	$\geq 10^{12}$	Ω
	$V_{IO} = 500\text{ V}$, $T_{amb} = 100\text{ }^{\circ}\text{C}$	R_{IO}	$\geq 10^{11}$	Ω
Storage temperature		T_{stg}	-55 to +150	$^{\circ}\text{C}$
Operating temperature		T_{amb}	-55 to +100	$^{\circ}\text{C}$
Lead soldering time ⁽¹⁾	at 260 $^{\circ}\text{C}$		10	s

Notes

- Stresses in excess of the absolute maximum ratings can cause permanent damage to the device. Functional operation of the device is not implied at these or any other conditions in excess of those given in the operational sections of this document. Exposure to absolute maximum ratings for extended periods of the time can adversely affect reliability.

⁽¹⁾ Refer to reflow profile for soldering conditions for surface mounted devices (SMD). Refer to wave profile for soldering conditions for through hole devices (DIP).

ELECTRICAL CHARACTERISTICS ($T_{amb} = 25\text{ }^{\circ}\text{C}$, unless otherwise specified)						
PARAMETER	TEST CONDITION	SYMBOL	MIN.	TYP.	MAX.	UNIT
INPUT						
Forward voltage	$I_F = 50\text{ mA}$	V_F	-	1.25	1.5	V
Reverse current	$V_R = 3\text{ V}$	I_R	-	0.1	100	μA
Capacitance	$V_R = 0\text{ V}$	C_O	-	25		pF
OUTPUT						
Collector emitter breakdown voltage ⁽¹⁾	$I_C = 100\text{ }\mu\text{A}$, $I_F = 0$	BV_{CEO}	30	-	-	V
Collector base breakdown voltage ⁽¹⁾	$I_C = 100\text{ }\mu\text{A}$, $I_F = 0$	BV_{CBO}	50	-	-	V
Emitter base breakdown voltage ⁽¹⁾	$I_C = 100\text{ }\mu\text{A}$, $I_F = 0$	BV_{EBO}	8	-	-	V
Emitter collector breakdown voltage ⁽¹⁾	$I_C = 100\text{ }\mu\text{A}$, $I_F = 0$	BV_{ECO}	5	10	-	V
Collector emitter leakage current	$V_{CE} = 10\text{ V}$, $I_F = 0$	I_{CEO}	-	1	100	nA
	$I_C = 0.5\text{ mA}$, $V_{CE} = 5\text{ V}$	h_{FE}	13	-	-	
COUPLER						
Collector emitter saturation voltage		V_{CEsat}	-	1	-	V
Coupling capacitance			-	1.5	-	pF

Notes

- Minimum and maximum values are testing requirements. Typical values are characteristics of the device and are the result of engineering evaluation. Typical values are for information only and are not part of the testing requirements

⁽¹⁾ Indicates JEDEC[®] registered values

CURRENT TRANSFER RATIO

PARAMETER	TEST CONDITION	SYMBOL	MIN.	TYP.	MAX.	UNIT
Current transfer ratio	$V_{CE} = 10\text{ V}$, $I_F = 10\text{ mA}$	CTR	500	-	-	%

SWITCHING CHARACTERISTICS

PARAMETER	TEST CONDITION	SYMBOL	MIN.	TYP.	MAX.	UNIT
Turn-on time	$V_{CC} = 10\text{ V}$, $I_C = 50\text{ mA}$	t_{on}	-	-	5	μs
Turn-off time	$I_F = 200\text{ mA}$, $R_L = 180\ \Omega$	t_{off}	-	-	100	μs

SAFETY AND INSULATION RATINGS

PARAMETER	TEST CONDITION	SYMBOL	MIN.	TYP.	MAX.	UNIT
Climatic classification (according to IEC 68 part 1)			-	55 / 100 / 21	-	
Comparative tracking index		CTI	175	-	399	
V_{IOTM}			8000	-	-	V
V_{IORM}			890	-	-	V
P_{SO}			-	-	700	mW
I_{SI}			-	-	400	mA
T_{SI}			-	-	175	$^{\circ}\text{C}$
Creepage distance	Standard DIP-6		7	-	-	mm
Clearance distance	Standard DIP-6		7	-	-	mm
Creepage distance	400 mil DIP-6		8	-	-	mm
Clearance distance	400 mil DIP-6		8	-	-	mm
Insulation thickness, reinforced rated	per IEC 60950 2.10.5.1		0.4	-	-	mm

Note

- As per IEC 60747-5-2, § 7.4.3.8.1, this optocoupler is suitable for “safe electrical insulation” only within the safety ratings. Compliance with the safety ratings shall be ensured by means of protective circuits

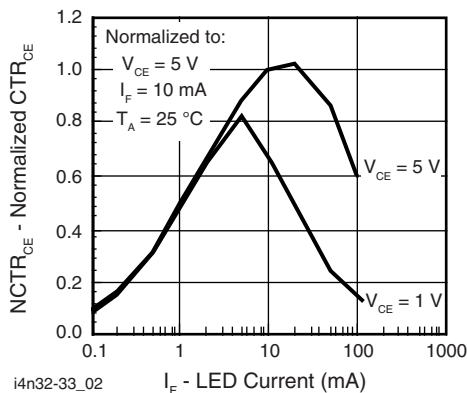
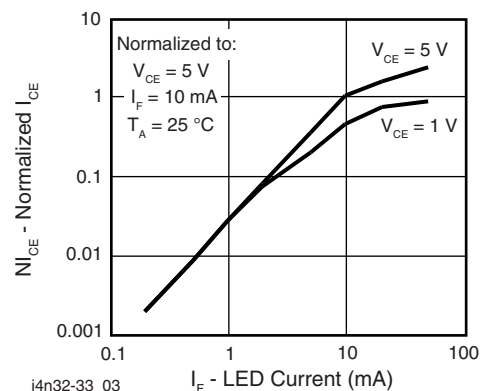
TYPICAL CHARACTERISTICS ($T_{amb} = 25\ ^{\circ}\text{C}$, unless otherwise specified)

 Fig. 1 - Normalized Non-Saturated and Saturated CTR_{CE} vs. LED Current


Fig. 2 - Normalized Non-Saturated and Saturated Collector Emitter Current vs. LED Current

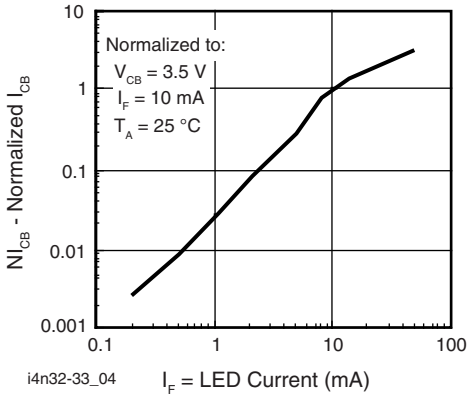


Fig. 3 - Normalized Collector Base Photocurrent vs. LED Current

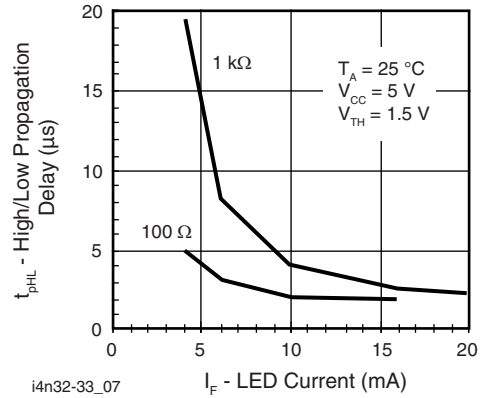


Fig. 6 - High to Low Propagation Delay vs. Collector Load Resistance and LED Current

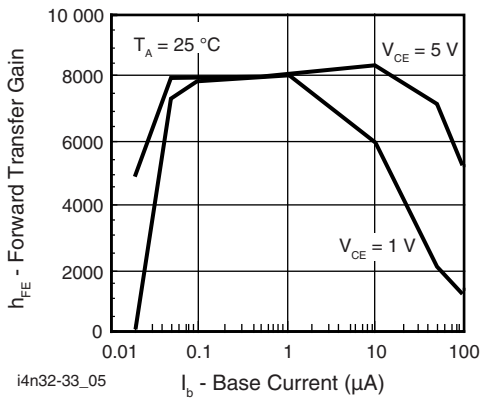
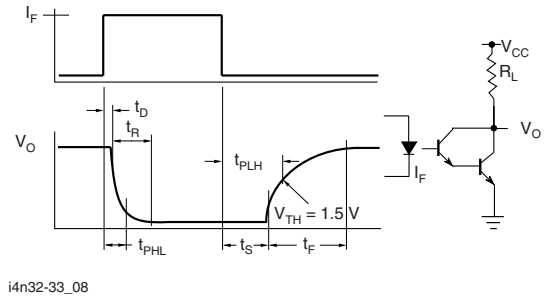


Fig. 4 - Non-Saturated and Saturated h_{FE} vs. Base Current



i4n32-33_08

Fig. 7 - Switching Waveform and Switching Schematic

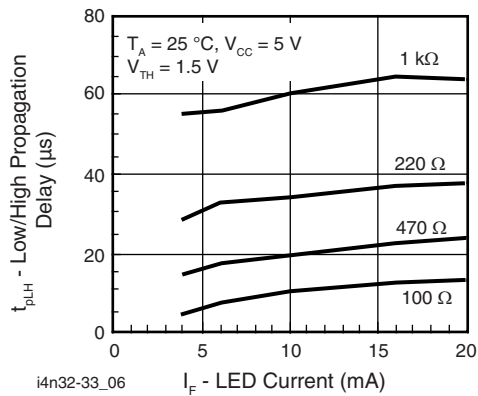
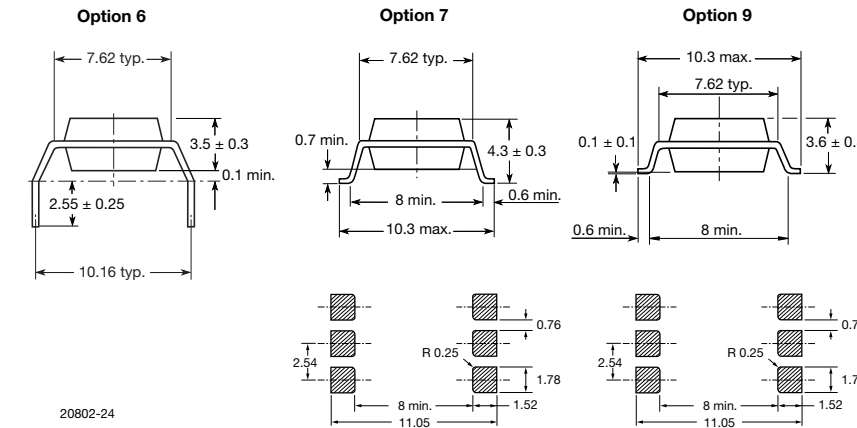
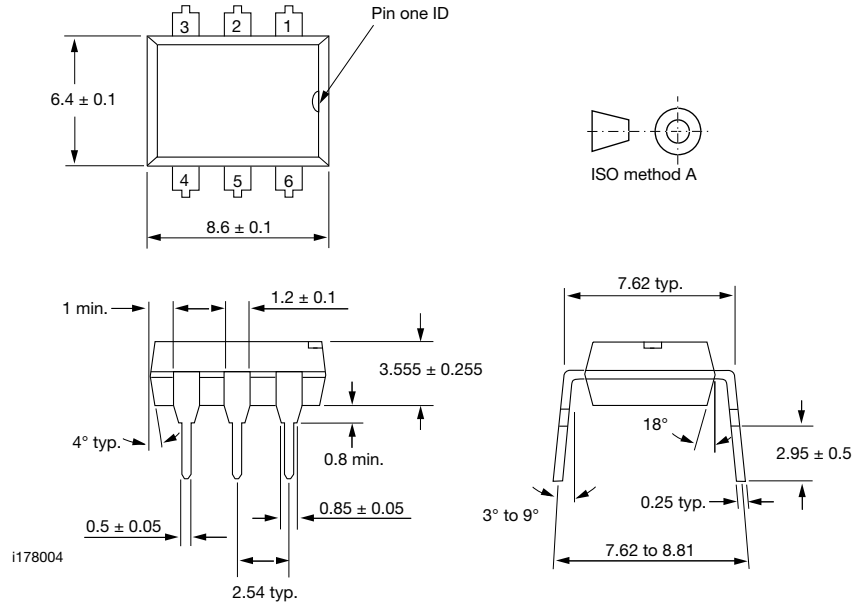


Fig. 5 - Low to High Propagation Delay vs. Collector Load Resistance and LED Current



PACKAGE DIMENSIONS in millimeters

DIP-6 Package Dimensions



PACKAGE MARKING



Notes

- Example marking for 4N32-X017T
- Only options 1, and 7 reflected in the package marking
- The VDE logo is only marked on option 1 parts
- Tape and reel suffix (T) is not part of the package marking



Disclaimer

ALL PRODUCT, PRODUCT SPECIFICATIONS AND DATA ARE SUBJECT TO CHANGE WITHOUT NOTICE TO IMPROVE RELIABILITY, FUNCTION OR DESIGN OR OTHERWISE.

Vishay Intertechnology, Inc., its affiliates, agents, and employees, and all persons acting on its or their behalf (collectively, "Vishay"), disclaim any and all liability for any errors, inaccuracies or incompleteness contained in any datasheet or in any other disclosure relating to any product.

Vishay makes no warranty, representation or guarantee regarding the suitability of the products for any particular purpose or the continuing production of any product. To the maximum extent permitted by applicable law, Vishay disclaims (i) any and all liability arising out of the application or use of any product, (ii) any and all liability, including without limitation special, consequential or incidental damages, and (iii) any and all implied warranties, including warranties of fitness for particular purpose, non-infringement and merchantability.

Statements regarding the suitability of products for certain types of applications are based on Vishay's knowledge of typical requirements that are often placed on Vishay products in generic applications. Such statements are not binding statements about the suitability of products for a particular application. It is the customer's responsibility to validate that a particular product with the properties described in the product specification is suitable for use in a particular application. Parameters provided in datasheets and / or specifications may vary in different applications and performance may vary over time. All operating parameters, including typical parameters, must be validated for each customer application by the customer's technical experts. Product specifications do not expand or otherwise modify Vishay's terms and conditions of purchase, including but not limited to the warranty expressed therein.

Except as expressly indicated in writing, Vishay products are not designed for use in medical, life-saving, or life-sustaining applications or for any other application in which the failure of the Vishay product could result in personal injury or death. Customers using or selling Vishay products not expressly indicated for use in such applications do so at their own risk. Please contact authorized Vishay personnel to obtain written terms and conditions regarding products designed for such applications.

No license, express or implied, by estoppel or otherwise, to any intellectual property rights is granted by this document or by any conduct of Vishay. Product names and markings noted herein may be trademarks of their respective owners.