

CSTCE10M0G52A-R0

In Production RoHS REACH

Appearance & Shape

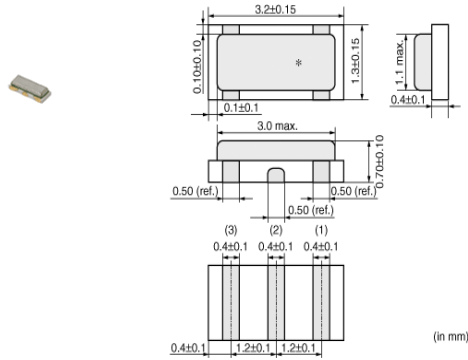

Features

MURATA's frequency adjustment and package technology expertise has enabled the development of the chip CERALOCK(R) with built-in load capacitors. This diverse series owes its development to MURATA's original mass production techniques and high reliability, and has achieved importance in the worldwide automotive market.

Features

1. The series has high reliability and is available for a wide temperature range.
2. Oscillation circuits do not require external load capacitors.
3. The series is available in a wide frequency range.
4. The resonators are extremely small and have a low profile.
5. No adjustment is necessary for oscillation circuits.

Applications

Automotive Usage	Powertrain/Safety
Other Usage	Automotive

Packaging Information

Packaging	Specifications	Minimum Order Quantity
-R0	180mm Embossed Tape	3000

Attention

1. This datasheet is downloaded from the website of Murata Manufacturing Co., Ltd. Therefore, its specifications are subject to change or our products may be discontinued without advance notice. Please check with our sales representatives or product engineers before ordering.
 2. This datasheet has only typical specifications because there is no space for detailed specifications. Therefore, please review our product specifications or consult the approval sheet for product specifications before ordering.

CSTCE10M0G52A-R0

Specifications

Shape	SMD
Frequency	10.000MHz
Frequency Tolerance	±0.5%
Operating Temperature Range	-40°C to 125°C
Frequency Shift by Temperature	±0.2%
Frequency Aging	±0.1%
Wash	available
Resonant Impedance	40Ω
Built-in Load Capacitance	10pF

Attention

1.This datasheet is downloaded from the website of Murata Manufacturing Co., Ltd. Therefore, it's specifications are subject to change or our products may be discontinued without advance notice. Please check with our sales representatives or product engineers before ordering.
2.This datasheet has only typical specifications because there is no space for detailed specifications.
Therefore, please review our product specifications or consult the approval sheet for product specifications before ordering.

CSTCE10M0G52A-R0

Product Data

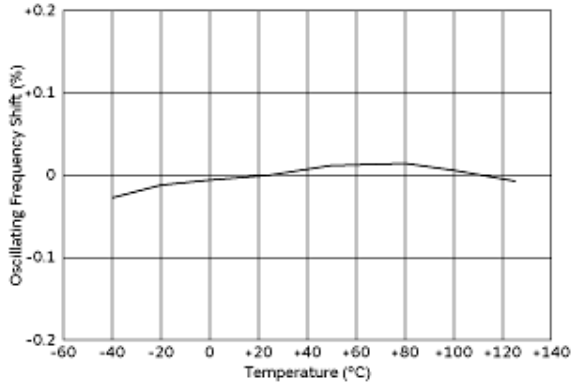

Temperature Characteristics

Attention

1. This datasheet is downloaded from the website of Murata Manufacturing Co., Ltd. Therefore, its specifications are subject to change or our products may be discontinued without advance notice. Please check with our sales representatives or product engineers before ordering.
2. This datasheet has only typical specifications because there is no space for detailed specifications.
Therefore, please review our product specifications or consult the approval sheet for product specifications before ordering.