

MMBT3906LT1

Preferred Device

General Purpose Transistor

PNP Silicon

Features

- Pb-Free Packages are Available

MAXIMUM RATINGS

| Rating | Symbol | Value | Unit |
|-----------------------------------|-----------|-------|------|
| Collector - Emitter Voltage | V_{CEO} | -40 | Vdc |
| Collector - Base Voltage | V_{CBO} | -40 | Vdc |
| Emitter - Base Voltage | V_{EBO} | -5.0 | Vdc |
| Collector Current - Continuous | I_C | -200 | mAdc |
| Collector Current - Peak (Note 3) | I_{CM} | -800 | mAdc |

THERMAL CHARACTERISTICS

| Characteristic | Symbol | Max | Unit |
|---|-----------------|-------------|----------------------------|
| Total Device Dissipation FR-5 Board (Note 1) @ $T_A = 25^\circ\text{C}$ Derate above 25°C | P_D | 225 1.8 | mW mW/ $^\circ\text{C}$ |
| Thermal Resistance, Junction-to-Ambient | $R_{\theta JA}$ | 556 | $^\circ\text{C}/\text{W}$ |
| Total Device Dissipation Alumina Substrate, (Note 2) @ $T_A = 25^\circ\text{C}$ Derate above 25°C | P_D | 300 2.4 | mW mW/ $^\circ\text{C}$ |
| Thermal Resistance, Junction-to-Ambient | $R_{\theta JA}$ | 417 | $^\circ\text{C}/\text{W}$ |
| Junction and Storage Temperature | T_J, T_{stg} | -55 to +150 | $^\circ\text{C}$ |

Maximum ratings are those values beyond which device damage can occur. Maximum ratings applied to the device are individual stress limit values (not normal operating conditions) and are not valid simultaneously. If these limits are exceeded, device functional operation is not implied, damage may occur and reliability may be affected.

- FR-5 = $1.0 \times 0.75 \times 0.062$ in.
- Alumina = $0.4 \times 0.3 \times 0.024$ in. 99.5% alumina.
- Reference SOA curve.



ON Semiconductor®

<http://onsemi.com>

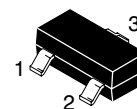
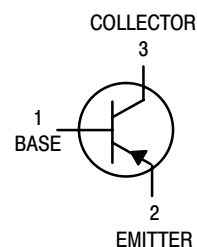

SOT-23 (TO-236)
CASE 318
STYLE 6

MARKING DIAGRAM

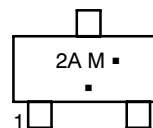

2A = Specific Device Code
M = Date Code*
■ = Pb-Free Package

(Note: Microdot may be in either location)

*Date Code orientation and/or overbar may vary depending upon manufacturing location.

ORDERING INFORMATION

| Device | Package | Shipping† |
|--------------|---------------------|----------------------|
| MMBT3906LT1 | SOT-23 | 3,000 / Tape & Reel |
| MMBT3906LT1G | SOT-23 (Pb-Free) | 3,000 / Tape & Reel |
| MMBT3906LT3 | SOT-23 | 10,000 / Tape & Reel |
| MMBT3906LT3G | SOT-23 (Pb-Free) | 10,000 / Tape & Reel |

†For information on tape and reel specifications, including part orientation and tape sizes, please refer to our Tape and Reel Packaging Specifications Brochure, BRD8011/D.

Preferred devices are recommended choices for future use and best overall value.

MMBT3906LT1

ELECTRICAL CHARACTERISTICS (T_A = 25°C unless otherwise noted)

| Characteristic | Symbol | Min | Max | Unit |
|---|----------------------|------|-----|------|
| OFF CHARACTERISTICS | | | | |
| Collector - Emitter Breakdown Voltage (I _C = -1.0 mAdc, I _B = 0) | V _{(BR)CEO} | -40 | - | Vdc |
| Collector - Base Breakdown Voltage (I _C = -10 μAdc, I _E = 0) | V _{(BR)CBO} | -40 | - | Vdc |
| Emitter - Base Breakdown Voltage (I _E = -10 μAdc, I _C = 0) | V _{(BR)EBO} | -5.0 | - | Vdc |
| Base Cutoff Current (V _{CE} = -30 Vdc, V _{EB} = -3.0 Vdc) | I _{BL} | - | -50 | nAdc |
| Collector Cutoff Current (V _{CE} = -30 Vdc, V _{EB} = -3.0 Vdc) | I _{CEX} | - | -50 | nAdc |

ON CHARACTERISTICS (Note 4)

| | | | | |
|---|----------------------|-----------------------------|-------------------------|-----|
| DC Current Gain (I _C = -0.1 mAdc, V _{CE} = -1.0 Vdc) (I _C = -1.0 mAdc, V _{CE} = -1.0 Vdc) (I _C = -10 mAdc, V _{CE} = -1.0 Vdc) (I _C = -50 mAdc, V _{CE} = -1.0 Vdc) (I _C = -100 mAdc, V _{CE} = -1.0 Vdc) | H _{FE} | 60 80 100 60 30 | - - 300 - - | - |
| Collector - Emitter Saturation Voltage (I _C = -10 mAdc, I _B = -1.0 mAdc) (I _C = -50 mAdc, I _B = -5.0 mAdc) | V _{CE(sat)} | - - | -0.25 -0.4 | Vdc |
| Base - Emitter Saturation Voltage (I _C = -10 mAdc, I _B = -1.0 mAdc) (I _C = -50 mAdc, I _B = -5.0 mAdc) | V _{BE(sat)} | -0.65 - | -0.85 -0.95 | Vdc |

SMALL-SIGNAL CHARACTERISTICS

| | | | | |
|--|------------------|-----|-----|--------------------|
| Current - Gain - Bandwidth Product (I _C = -10 mAdc, V _{CE} = -20 Vdc, f = 100 MHz) | f _T | 250 | - | MHz |
| Output Capacitance (V _{CB} = -5.0 Vdc, I _E = 0, f = 1.0 MHz) | C _{obo} | - | 4.5 | pF |
| Input Capacitance (V _{EB} = -0.5 Vdc, I _C = 0, f = 1.0 MHz) | C _{ibo} | - | 10 | pF |
| Input Impedance (I _C = -1.0 mAdc, V _{CE} = -10 Vdc, f = 1.0 kHz) | h _{ie} | 2.0 | 12 | kΩ |
| Voltage Feedback Ratio (I _C = -1.0 mAdc, V _{CE} = -10 Vdc, f = 1.0 kHz) | h _{re} | 0.1 | 10 | X 10 ⁻⁴ |
| Small - Signal Current Gain (I _C = -1.0 mAdc, V _{CE} = -10 Vdc, f = 1.0 kHz) | h _{fe} | 100 | 400 | - |
| Output Admittance (I _C = -1.0 mAdc, V _{CE} = -10 Vdc, f = 1.0 kHz) | h _{oe} | 3.0 | 60 | μmhos |
| Noise Figure (I _C = -100 μAdc, V _{CE} = -5.0 Vdc, R _S = 1.0 kΩ, f = 1.0 kHz) | NF | - | 4.0 | dB |

SWITCHING CHARACTERISTICS

| | | | | | |
|--------------|--|----------------|---|-----|----|
| Delay Time | (V _{CC} = -3.0 Vdc, V _{BE} = 0.5 Vdc, I _C = -10 mAdc, I _{B1} = -1.0 mAdc) | t _d | - | 35 | ns |
| Rise Time | | t _r | - | 35 | |
| Storage Time | (V _{CC} = -3.0 Vdc, I _C = -10 mAdc, I _{B1} = I _{B2} = -1.0 mAdc) | t _s | - | 225 | ns |
| Fall Time | | t _f | - | 75 | |

4. Pulse Test: Pulse Width ≤ 300 μs, Duty Cycle ≤ 2.0%.

MMBT3906LT1

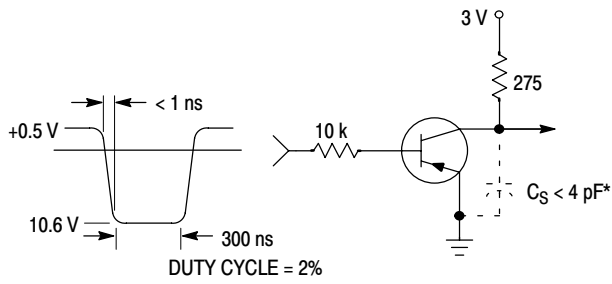

Figure 1. Delay and Rise Time Equivalent Test Circuit

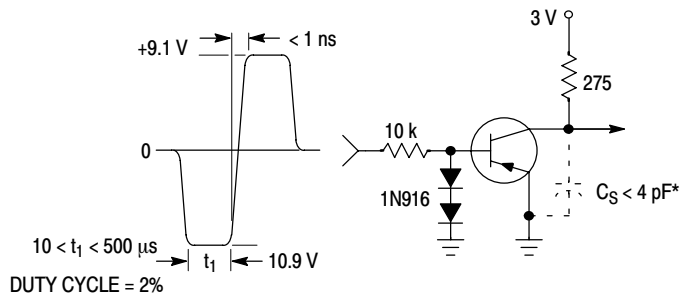

Figure 2. Storage and Fall Time Equivalent Test Circuit

* Total shunt capacitance of test jig and connectors

TYPICAL TRANSIENT CHARACTERISTICS

— $T_J = 25^\circ\text{C}$
 - - $T_J = 125^\circ\text{C}$

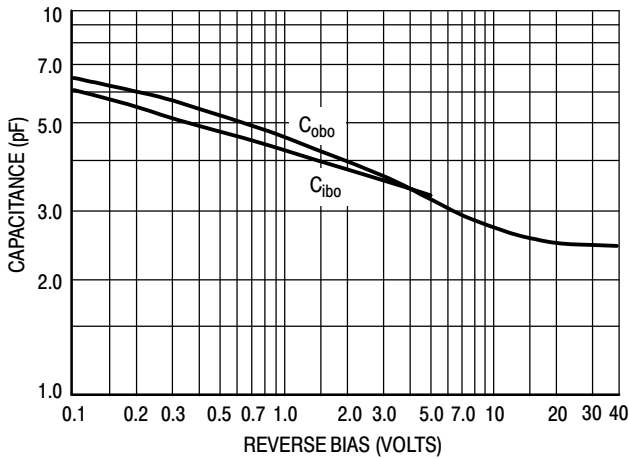

Figure 3. Capacitance

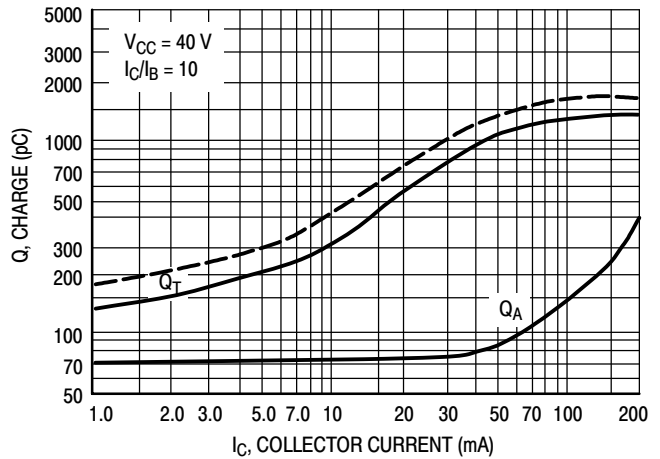

Figure 4. Charge Data

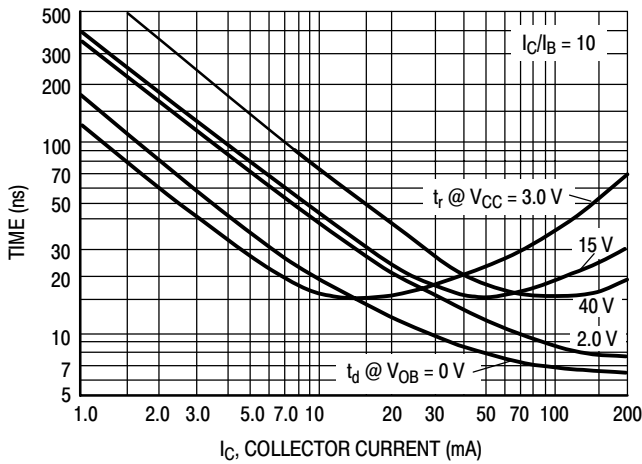

Figure 5. Turn-On Time

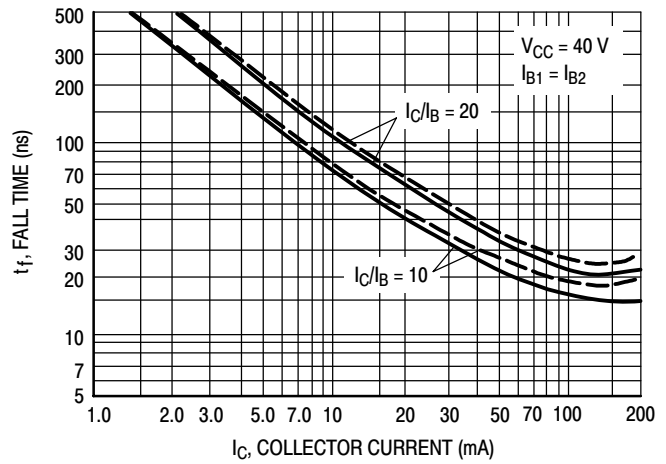

Figure 6. Fall Time

MMBT3906LT1

TYPICAL AUDIO SMALL-SIGNAL CHARACTERISTICS NOISE FIGURE VARIATIONS

($V_{CE} = -5.0$ Vdc, $T_A = 25^\circ\text{C}$, Bandwidth = 1.0 Hz)

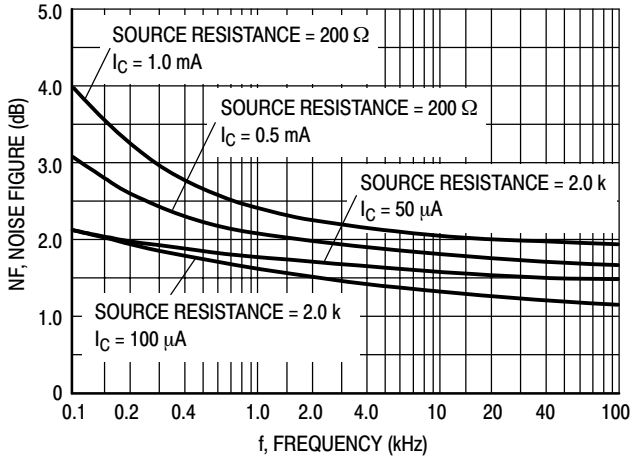

Figure 7.

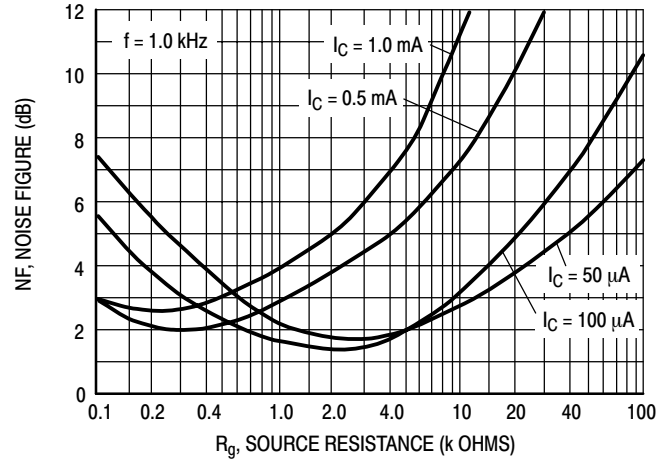

Figure 8.

h PARAMETERS

($V_{CE} = -10$ Vdc, $f = 1.0$ kHz, $T_A = 25^\circ\text{C}$)

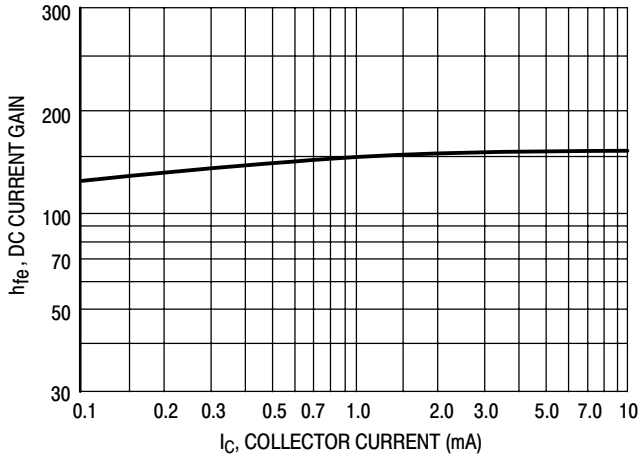

Figure 9. Current Gain

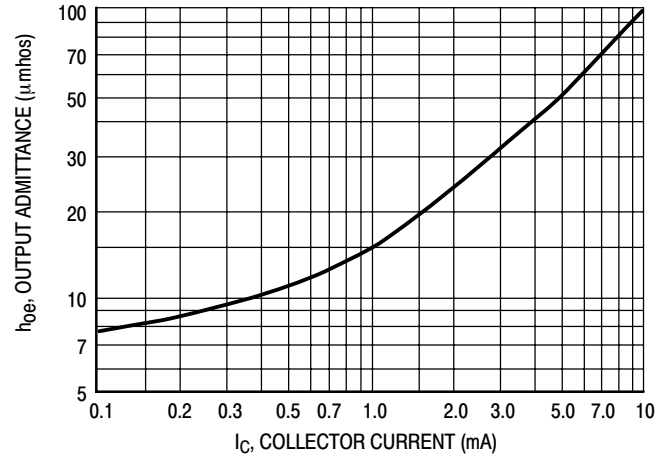

Figure 10. Output Admittance

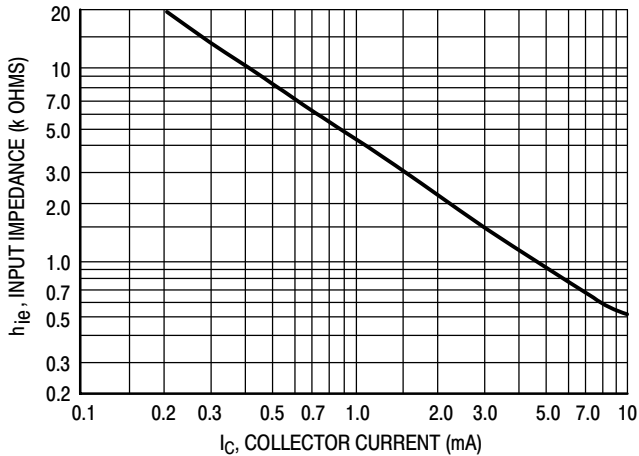

Figure 11. Input Impedance

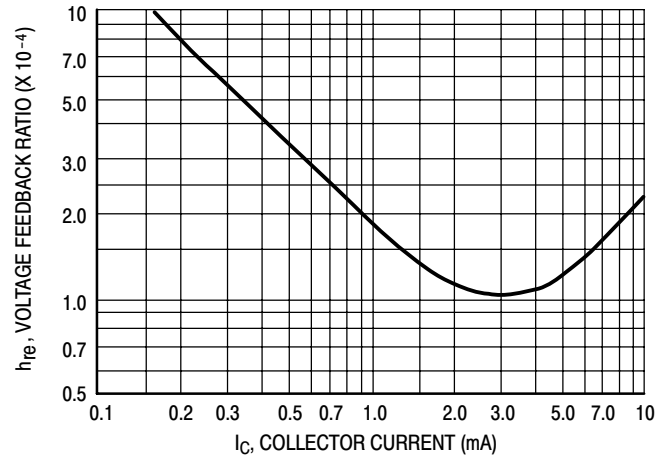

Figure 12. Voltage Feedback Ratio

MMBT3906LT1

TYPICAL STATIC CHARACTERISTICS

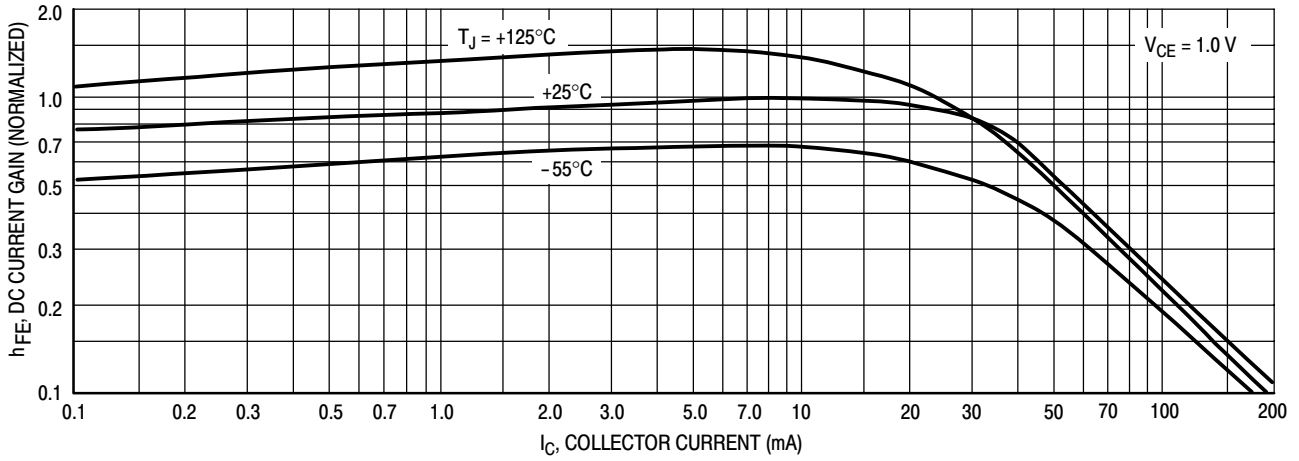

Figure 13. DC Current Gain

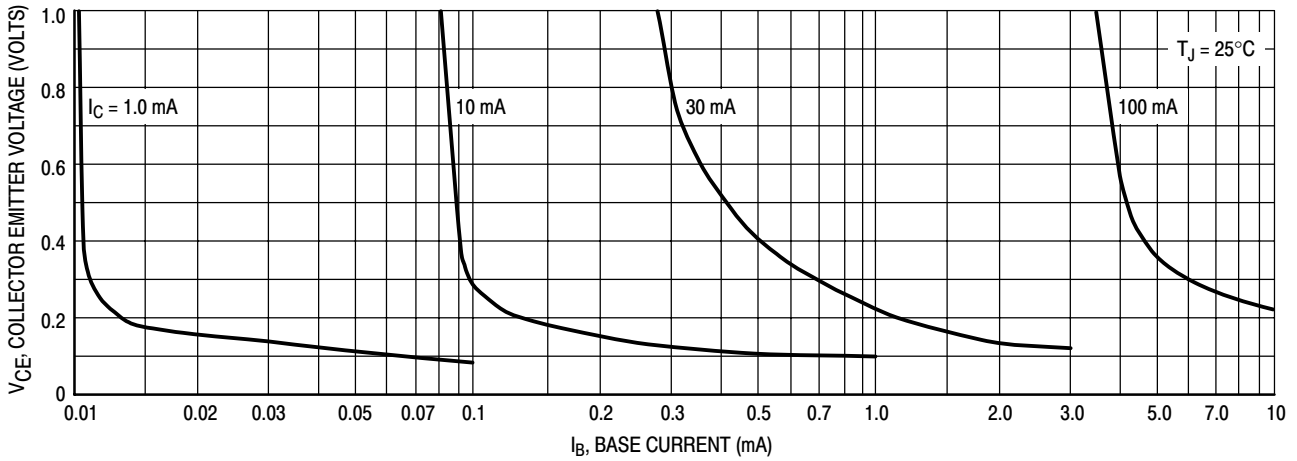

Figure 14. Collector Saturation Region

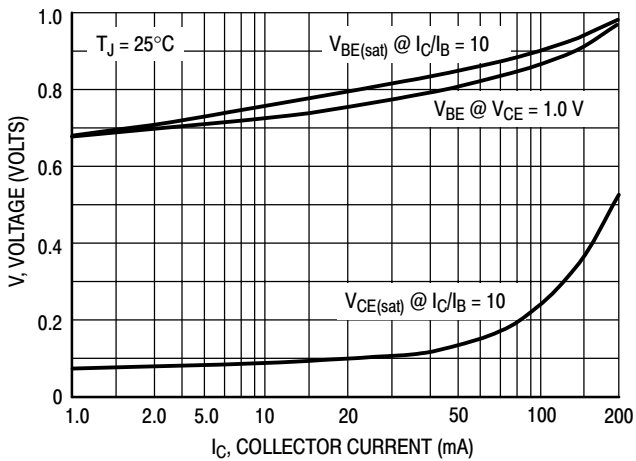

Figure 15. "ON" Voltages

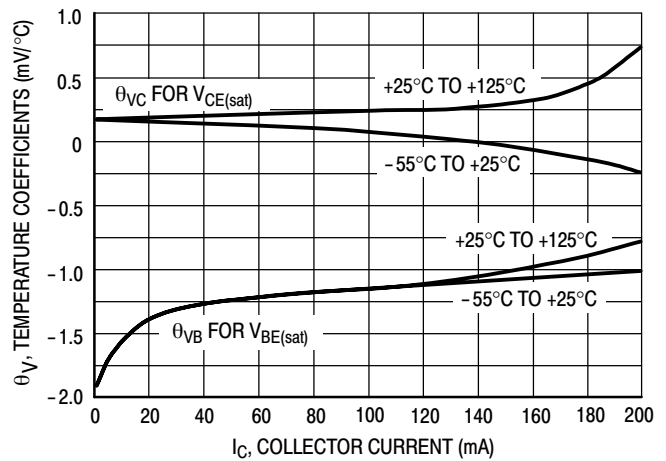

Figure 16. Temperature Coefficients

MMBT3906LT1

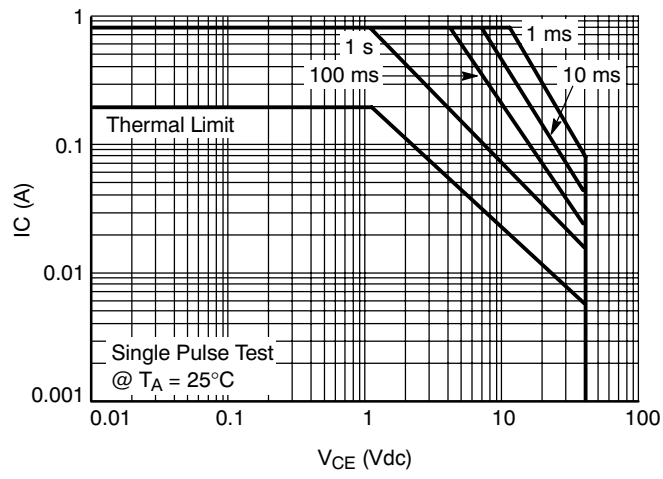
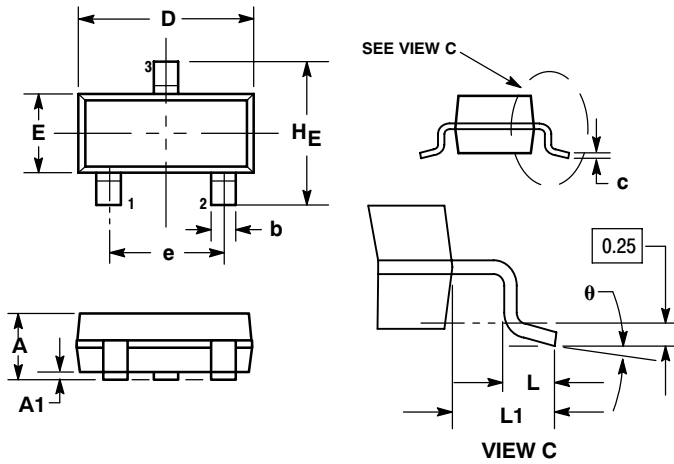

Figure 17. Safe Operating Area

MMBT3906LT1

PACKAGE DIMENSIONS

SOT-23 (TO-236)
CASE 318-08
ISSUE AN



NOTES:

1. DIMENSIONING AND TOLERANCING PER ANSI Y14.5M, 1982.
2. CONTROLLING DIMENSION: INCH.
3. MAXIMUM LEAD THICKNESS INCLUDES LEAD FINISH THICKNESS. MINIMUM LEAD THICKNESS IS THE MINIMUM THICKNESS OF BASE MATERIAL.
4. 318-01 THRU -07 AND -09 OBSOLETE, NEW STANDARD 318-08.

| DIM | MILLIMETERS | | | INCHES | | |
|-----|-------------|------|------|--------|-------|-------|
| | MIN | NOM | MAX | MIN | NOM | MAX |
| A | 0.89 | 1.00 | 1.11 | 0.035 | 0.040 | 0.044 |
| A1 | 0.01 | 0.06 | 0.10 | 0.001 | 0.002 | 0.004 |
| b | 0.37 | 0.44 | 0.50 | 0.015 | 0.018 | 0.020 |
| c | 0.09 | 0.13 | 0.18 | 0.003 | 0.005 | 0.007 |
| D | 2.80 | 2.90 | 3.04 | 0.110 | 0.114 | 0.120 |
| E | 1.20 | 1.30 | 1.40 | 0.047 | 0.051 | 0.055 |
| e | 1.78 | 1.90 | 2.04 | 0.070 | 0.075 | 0.081 |
| L | 0.10 | 0.20 | 0.30 | 0.004 | 0.008 | 0.012 |
| L1 | 0.35 | 0.54 | 0.69 | 0.014 | 0.021 | 0.029 |
| HE | 2.10 | 2.40 | 2.64 | 0.083 | 0.094 | 0.104 |

STYLE 6:

1. BASE
2. EMITTER
3. COLLECTOR

SOLDERING FOOTPRINT*

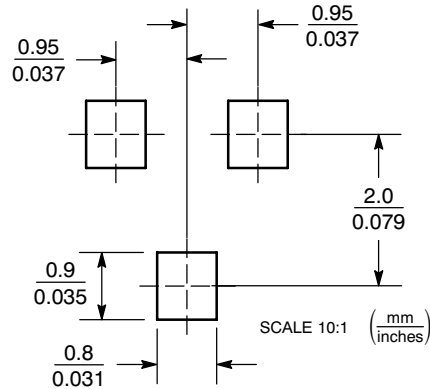

*For additional information on our Pb-Free strategy and soldering details, please download the ON Semiconductor Soldering and Mounting Techniques Reference Manual, SOLDERRM/D.

ON Semiconductor and are registered trademarks of Semiconductor Components Industries, LLC (SCILLC). SCILLC reserves the right to make changes without further notice to any products herein. SCILLC makes no warranty, representation or guarantee regarding the suitability of its products for any particular purpose, nor does SCILLC assume any liability arising out of the application or use of any product or circuit, and specifically disclaims any and all liability, including without limitation special, consequential or incidental damages. "Typical" parameters which may be provided in SCILLC data sheets and/or specifications can and do vary in different applications and actual performance may vary over time. All operating parameters, including "Typicals" must be validated for each customer application by customer's technical experts. SCILLC does not convey any license under its patent rights nor the rights of others. SCILLC products are not designed, intended, or authorized for use as components in systems intended for surgical implant into the body, or other applications intended to support or sustain life, or for any other application in which the failure of the SCILLC product could create a situation where personal injury or death may occur. Should Buyer purchase or use SCILLC products for any such unintended or unauthorized application, Buyer shall indemnify and hold SCILLC and its officers, employees, subsidiaries, affiliates, and distributors harmless against all claims, costs, damages, and expenses, and reasonable attorney fees arising out of, directly or indirectly, any claim of personal injury or death associated with such unintended or unauthorized use, even if such claim alleges that SCILLC was negligent regarding the design or manufacture of the part. SCILLC is an Equal Opportunity/Affirmative Action Employer. This literature is subject to all applicable copyright laws and is not for resale in any manner.

PUBLICATION ORDERING INFORMATION

LITERATURE FULFILLMENT:

Literature Distribution Center for ON Semiconductor
P.O. Box 61312, Phoenix, Arizona 85082-1312 USA
Phone: 480-829-7710 or 800-344-3860 Toll Free USA/Canada
Fax: 480-829-7709 or 800-344-3867 Toll Free USA/Canada
Email: orderlit@onsemi.com

N. American Technical Support: 800-282-9855 Toll Free
USA/Canada

Japan: ON Semiconductor, Japan Customer Focus Center
2-9-1 Kamimeguro, Meguro-ku, Tokyo, Japan 153-0051
Phone: 81-3-5773-3850

ON Semiconductor Website: <http://onsemi.com>

Order Literature: <http://www.onsemi.com/litorder>

For additional information, please contact your local Sales Representative.