

2MBI200S-120

IGBT Module

1200V / 200A 2 in one-package

■ Features

- High speed switching
- Voltage drive
- Low inductance module structure

■ Applications

- Inverter for Motor drive
- AC and DC Servo drive amplifier
- Uninterruptible power supply
- Industrial machines, such as Welding machines

■ Maximum ratings and characteristics

● Absolute maximum ratings (at Tc=25°C unless otherwise specified)

Item	Symbol	Rating	Unit	
Collector-Emitter voltage	V _{CEs}	1200	V	
Gate-Emitter voltage	V _{GES}	±20	V	
Collector current	Continuous	T _c =25°C	300	A
		T _c =80°C	200	A
	1ms	T _c =25°C	600	A
		T _c =80°C	400	A
	1ms	-I _c	200	A
	-I _c pulse	400	A	
Max. power dissipation	P _c	1500	W	
Operating temperature	T _j	+150	°C	
Storage temperature	T _{stg}	-40 to +125	°C	
Isolation voltage *1	V _{is}	AC 2500 (1min.)	V	
Screw torque	Mounting *2	3.5	N·m	
	Terminals *2	4.5	N·m	

*1 : All terminals should be connected together when isolation test will be done

*2 : Recommendable value : Mounting 2.5 to 3.5 N·m(M5 or M6)
Terminals 3.5 to 4.5 N·m(M6)

● Electrical characteristics (at T_j=25°C unless otherwise specified)

Item	Symbol	Characteristics			Conditions	Unit	
		Min.	Typ.	Max.			
Zero gate voltage collector current	I _{CEs}	-	-	1.0	V _{GE} =0V, V _{CE} =1200V	mA	
Gate-Emitter leakage current	I _{GES}	-	-	0.4	V _{CE} =0V, V _{GE} =±20V	μA	
Gate-Emitter threshold voltage	V _{GE(th)}	5.5	7.2	8.5	V _{CE} =20V, I _c =200mA	V	
Collector-Emitter saturation voltage	V _{CE(sat)}	-	2.3	2.6	T _c =25°C	V _{GE} =15V, I _c =200A	V
		-	2.8	-	T _c =125°C		
Input capacitance	C _{ies}	-	24000	-	V _{GE} =0V	pF	
Output capacitance	C _{oes}	-	5000	-	V _{CE} =10V		
Reverse transfer capacitance	C _{res}	-	4400	-	f=1MHz		
Turn-on time	t _{on}	-	0.35	1.2	V _{CC} =600V	μs	
	t _r	-	0.25	0.6	I _c =200A		
	t _{r(i)}	-	0.1	-	V _{GE} =±15V		
Turn-off time	t _{off}	-	0.45	1.0	R _G =4.7 ohm	μs	
	t _f	-	0.08	0.3			
Forward on voltage	V _F	-	2.3	3.0	T _j =25°C	I _F =200A, V _{GE} =0V	V
		-	2.0	-	T _j =125°C		
Reverse recovery time	t _{rr}	-	-	0.35	I _F =200A	μs	

● Thermal resistance characteristics

Item	Symbol	Characteristics			Conditions	Unit
		Min.	Typ.	Max.		
Thermal resistance	R _{th(j-c)}	-	-	0.085	IGBT	°C/W
	R _{th(j-c)}	-	-	0.18	Diode	°C/W
	R _{th(c-f)*2}	-	0.025	-	the base to cooling fin	°C/W

*2 : This is the value which is defined mounting on the additional cooling fin with thermal compound



■ Equivalent Circuit Schematic

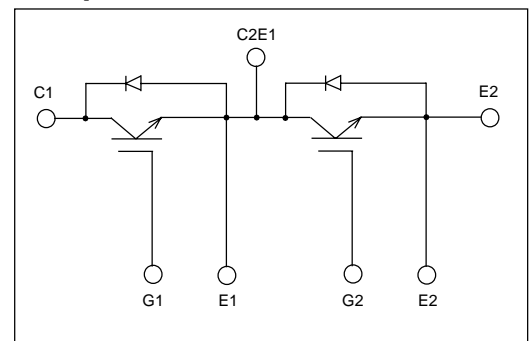

Characteristics (Representative)

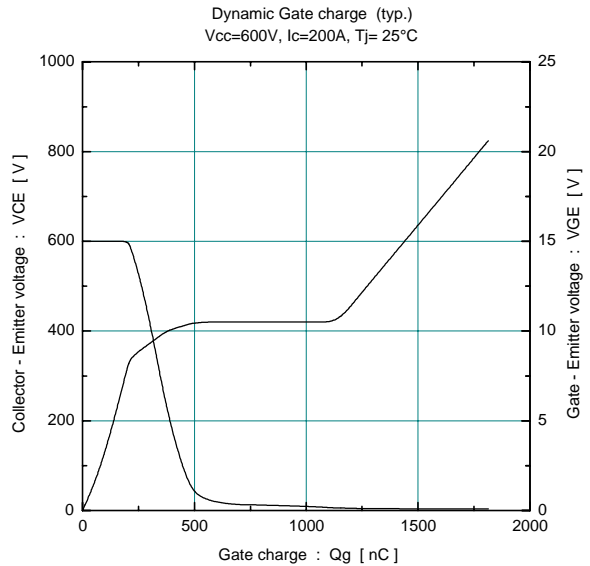
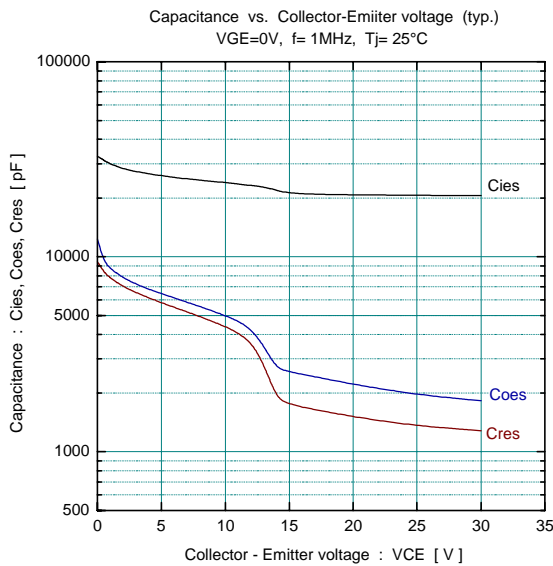
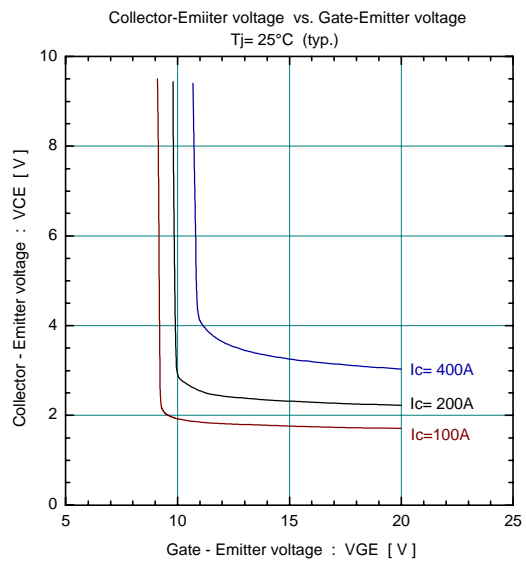
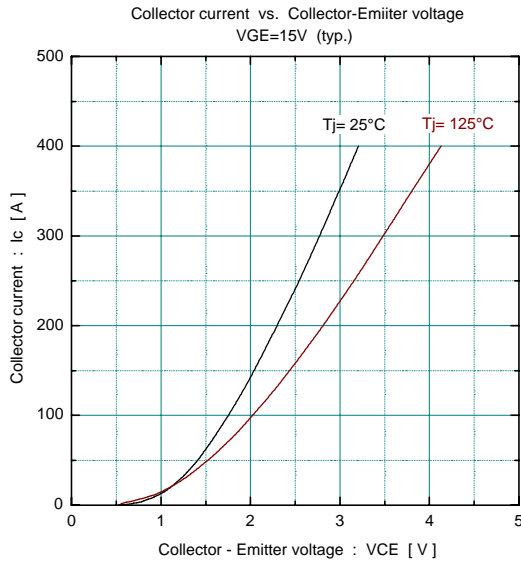
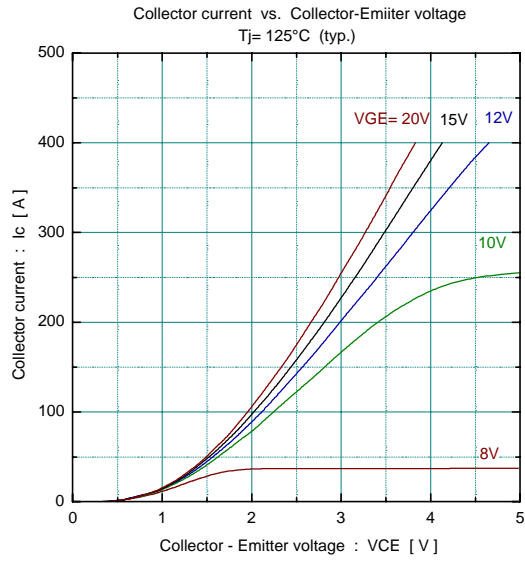
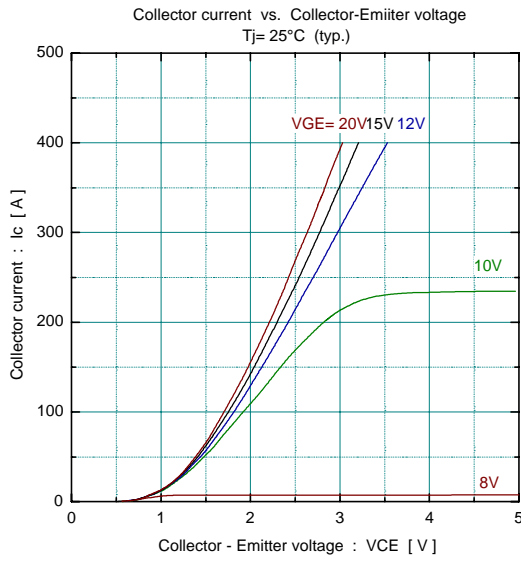

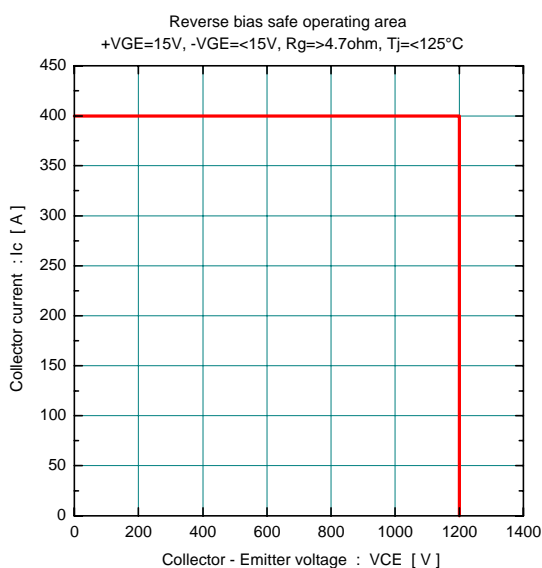
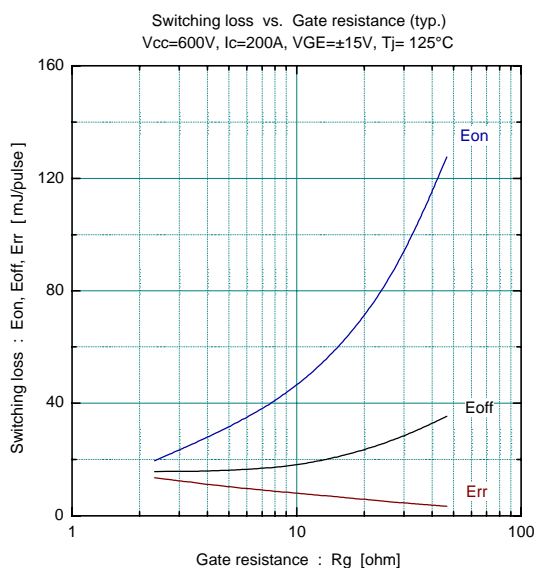
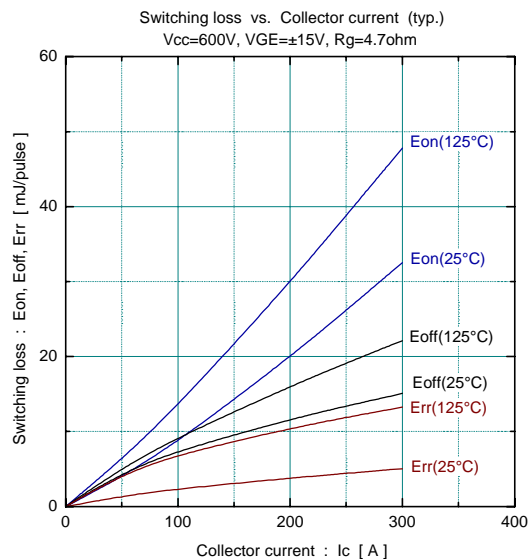
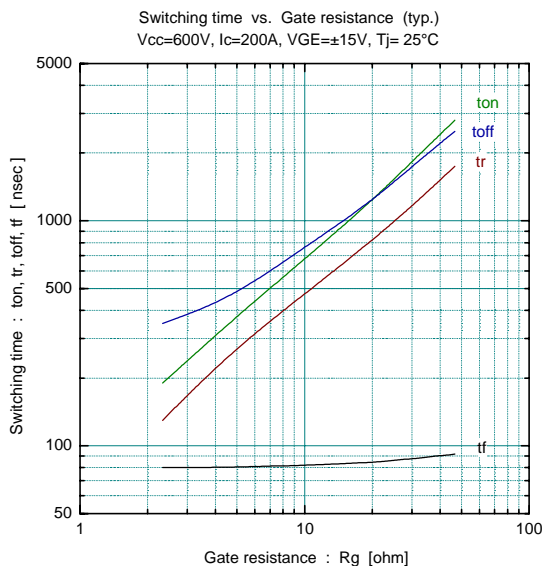
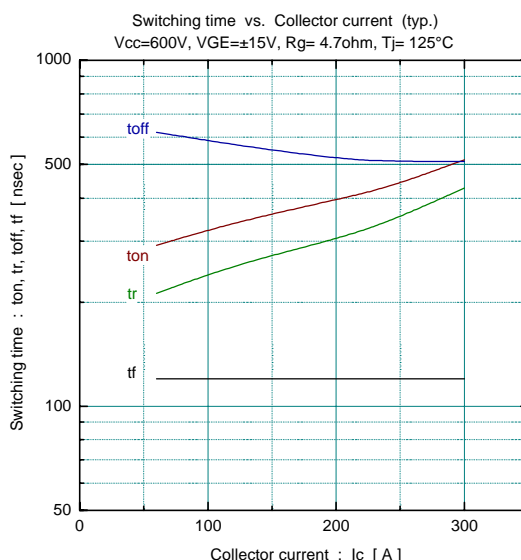
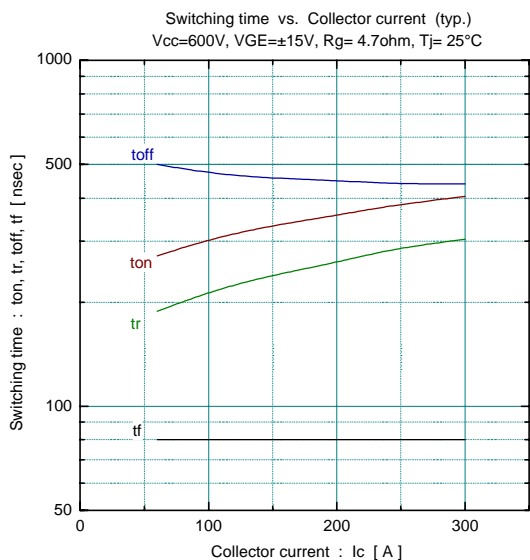

Forward current vs. Forward on voltage (typ.)

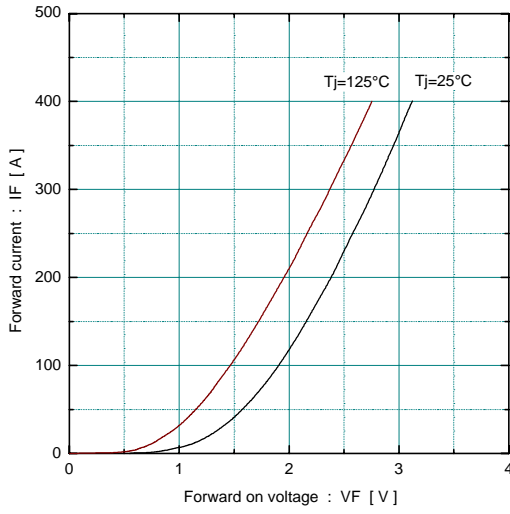

Reverse recovery characteristics (typ.)
Vcc=600V, VGE=±15V, Rg=4.7ohm

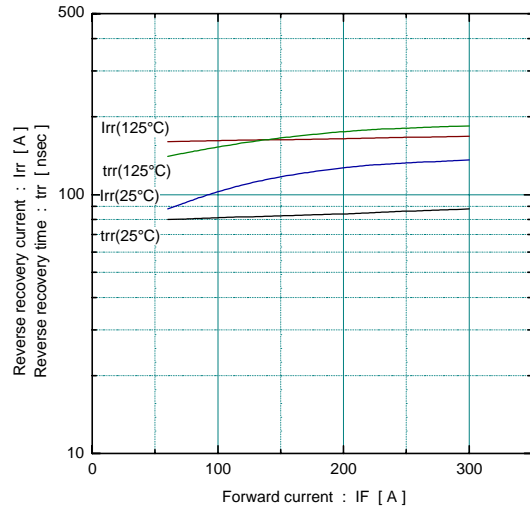

Transient thermal resistance

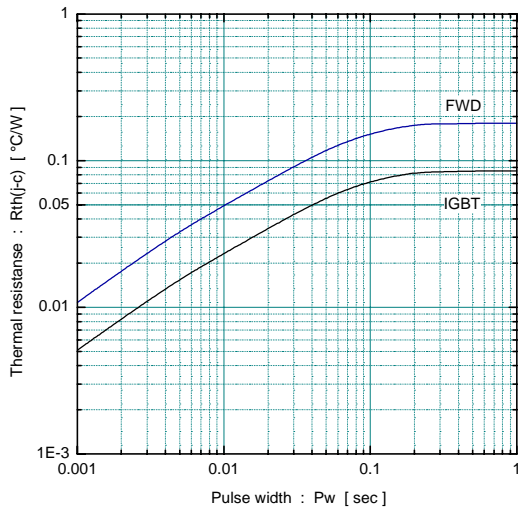

■ Outline Drawings, mm

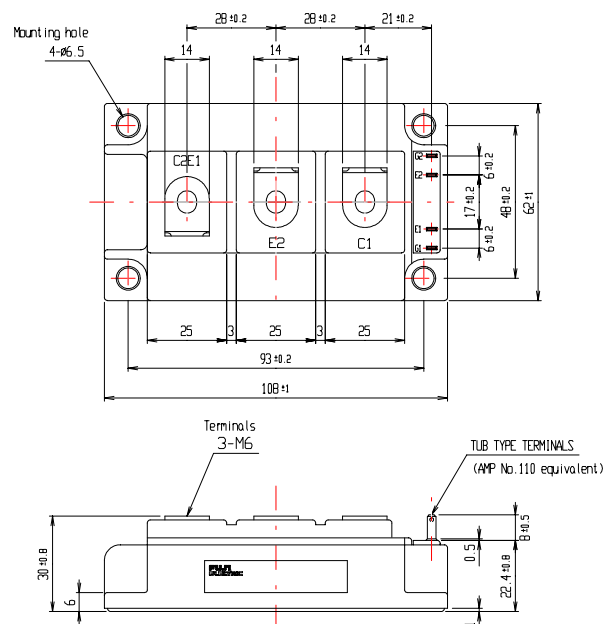

mass : 370g