

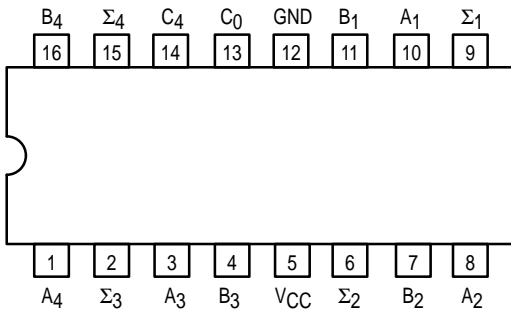

4-BIT BINARY FULL ADDER WITH FAST CARRY

The SN54/74LS83A is a high-speed 4-Bit binary Full Adder with internal carry lookahead. It accepts two 4-bit binary words (A_1-A_4 , B_1-B_4) and a Carry Input (C_0). It generates the binary Sum outputs $\Sigma_1-\Sigma_4$ and the Carry Output (C_4) from the most significant bit. The LS83A operates with either active HIGH or active LOW operands (positive or negative logic). The SN54/74LS283 is recommended for new designs since it is identical in function with this device and features standard corner power pins.

CONNECTION DIAGRAM DIP (TOP VIEW)



NOTE:
The Flatpak version has the same pinouts (Connection Diagram) as the Dual In-Line Package.

PIN NAMES

- A_1-A_4 Operand A Inputs
- B_1-B_4 Operand B Inputs
- C_0 Carry Input
- $\Sigma_1-\Sigma_4$ Sum Outputs (Note b)
- C_4 Carry Output (Note b)

NOTES:

- a) 1 TTL Unit Load (U.L.) = 40 μ A HIGH/1.6 mA LOW.
- b) The Output LOW drive factor is 2.5 U.L. for Military (54) and 5 U.L. for Commercial (74) Temperature Ranges.

LOADING (Note a)

| HIGH | LOW |
|----------|--------------|
| 1.0 U.L. | 0.5 U.L. |
| 1.0 U.L. | 0.5 U.L. |
| 0.5 U.L. | 0.25 U.L. |
| 10 U.L. | 5 (2.5) U.L. |
| 10 U.L. | 5 (2.5) U.L. |

LOGIC DIAGRAM

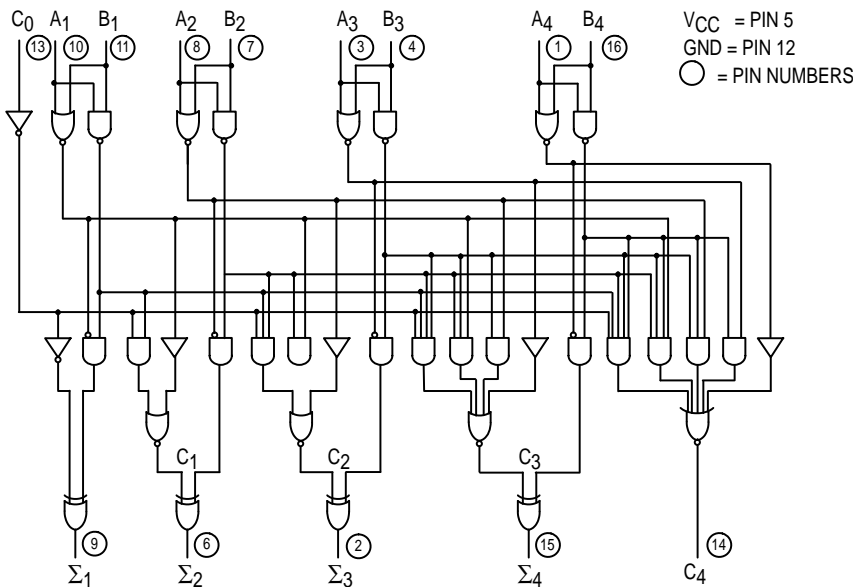

SN54/74LS83A

4-BIT BINARY FULL ADDER WITH FAST CARRY

LOW POWER SCHOTTKY

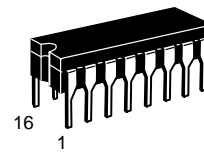

J SUFFIX
CERAMIC
CASE 620-09

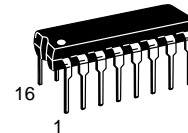

N SUFFIX
PLASTIC
CASE 648-08

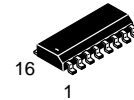

D SUFFIX
SOIC
CASE 751B-03

ORDERING INFORMATION

- SN54LSXXJ Ceramic
- SN74LSXXN Plastic
- SN74LSXXD SOIC

LOGIC SYMBOL

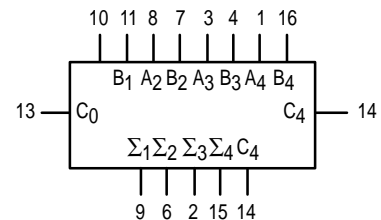

SN54/74LS83A

FUNCTIONAL DESCRIPTION

The LS83A adds two 4-bit binary words (A plus B) plus the incoming carry. The binary sum appears on the sum outputs ($\Sigma_1 - \Sigma_4$) and outgoing carry (C_4) outputs.

$$C_0 + (A_1+B_1)+2(A_2+B_2)+4(A_3+B_3)+8(A_4+B_4) = \Sigma_1+2\Sigma_2+4\Sigma_3+8\Sigma_4+16C_4$$

Where: (+) = plus

Due to the symmetry of the binary add function the LS83A can be used with either all inputs and outputs active HIGH (positive logic) or with all inputs and outputs active LOW (negative logic). Note that with active HIGH Inputs, Carry Input can not be left open, but must be held LOW when no carry in is intended.

Example:

| | C ₀ | A ₁ | A ₂ | A ₃ | A ₄ | B ₁ | B ₂ | B ₃ | B ₄ | Σ ₁ | Σ ₂ | Σ ₃ | Σ ₄ | C ₄ |
|--------------|----------------|----------------|----------------|----------------|----------------|----------------|----------------|----------------|----------------|----------------|----------------|----------------|----------------|----------------|
| Logic Levels | L | L | H | L | H | H | L | L | H | H | H | L | L | H |
| Active HIGH | 0 | 0 | 1 | 0 | 1 | 1 | 0 | 0 | 1 | 1 | 1 | 0 | 0 | 1 |
| Active LOW | 1 | 1 | 0 | 1 | 0 | 0 | 1 | 1 | 0 | 0 | 0 | 1 | 1 | 0 |

(10+9 = 19)
(carry+5+6 = 12)

Interchanging inputs of equal weight does not affect the operation, thus C₀, A₁, B₁, can be arbitrarily assigned to pins 10, 11, 13, etc.

FUNCTIONAL TRUTH TABLE

| C (n-1) | A _n | B _n | Σ _n | C _n |
|---------|----------------|----------------|----------------|----------------|
| L | L | L | L | L |
| L | L | H | H | L |
| L | H | L | H | L |
| L | H | H | L | H |
| H | L | L | H | L |
| H | L | H | L | H |
| H | H | L | L | H |
| H | H | H | H | H |

C₁ — C₃ are generated internally
 C₀ — is an external input
 C₄ — is an output generated internally

GUARANTEED OPERATING RANGES

| Symbol | Parameter | | Min | Typ | Max | Unit |
|-----------------|-------------------------------------|----------|-------------|------------|-------------|------|
| V _{CC} | Supply Voltage | 54 74 | 4.5 4.75 | 5.0 5.0 | 5.5 5.25 | V |
| T _A | Operating Ambient Temperature Range | 54 74 | -55 0 | 25 25 | 125 70 | °C |
| I _{OH} | Output Current — High | 54, 74 | | | -0.4 | mA |
| I _{OL} | Output Current — Low | 54 74 | | | 4.0 8.0 | mA |

SN54/74LS83A

DC CHARACTERISTICS OVER OPERATING TEMPERATURE RANGE (unless otherwise specified)

| Symbol | Parameter | Limits | | | Unit | Test Conditions | |
|-----------------|---|--------|-------|----------------|------|---|---|
| | | Min | Typ | Max | | | |
| V _{IH} | Input HIGH Voltage | 2.0 | | | V | Guaranteed Input HIGH Voltage for All Inputs | |
| V _{IL} | Input LOW Voltage | 54 | | 0.7 | V | Guaranteed Input LOW Voltage for All Inputs | |
| | | 74 | | 0.8 | | | |
| V _{IK} | Input Clamp Diode Voltage | | -0.65 | -1.5 | V | V _{CC} = MIN, I _{IN} = -18 mA | |
| V _{OH} | Output HIGH Voltage | 54 | 2.5 | 3.5 | V | V _{CC} = MIN, I _{OH} = MAX, V _{IN} = V _{IH} per Truth Table | |
| | | 74 | 2.7 | 3.5 | V | | |
| V _{OL} | Output LOW Voltage | 54, 74 | | 0.25 | 0.4 | V | I _{OL} = 4.0 mA V _{CC} = V _{CC} MIN, V _{IN} = V _{IL} or V _{IH} per Truth Table |
| | | 74 | | 0.35 | 0.5 | V | |
| I _{IH} | Input HIGH Current C ₀ A or B | | | 20 40 | μA | V _{CC} = MAX, V _{IN} = 2.7 V | |
| | C ₀ A or B | | | 0.1 0.2 | mA | V _{CC} = MAX, V _{IN} = 7.0 V | |
| I _{IL} | Input LOW Current C ₀ A or B | | | -0.4 -0.8 | mA | V _{CC} = MAX, V _{IN} = 0.4 V | |
| I _{OS} | Output Short Circuit Current (Note 1) | -20 | | -100 | mA | V _{CC} = MAX | |
| I _{CC} | Power Supply Current All Inputs Grounded All Inputs at 4.5 V, Except B All Inputs at 4.5 V | | | 39 34 34 | mA | V _{CC} = MAX | |

Note 1: Not more than one output should be shorted at a time, nor for more than 1 second.

AC CHARACTERISTICS (T_A = 25°C)

| Symbol | Parameter | Limits | | | Unit | Test Conditions |
|--------------------------------------|--|--------|----------|----------|------|--|
| | | Min | Typ | Max | | |
| t _{PLH} t _{PHL} | Propagation Delay, C ₀ Input to any Σ Output | | 16 15 | 24 24 | ns | V _{CC} = 5.0 V C _L = 15 pF Figures 1 and 2 |
| t _{PLH} t _{PHL} | Propagation Delay, Any A or B Input to Σ Outputs | | 15 15 | 24 24 | ns | |
| t _{PLH} t _{PHL} | Propagation Delay, C ₀ Input to C ₄ Output | | 11 15 | 17 22 | ns | |
| t _{PLH} t _{PHL} | Propagation Delay, Any A or B Input to C ₄ Output | | 11 12 | 17 17 | ns | |

AC WAVEFORMS

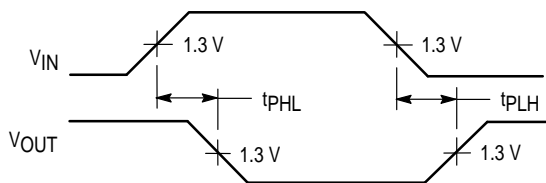

Figure 1

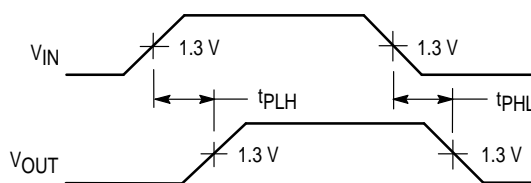

Figure 2