

SKT 491



Capsule Thyristor

Line Thyristor

SKT 491

Features

- Hermetic metal case with ceramic insulator
- Capsule package for double sided cooling
- Shallow design with single sided cooling
- International standard case
- Off-state and reverse voltages up to 1800 V
- Amplifying gate

Typical Applications

- DC motor control (e. g. for machine tools)
- Controlled rectifiers (e. g. for battery charging)
- AC controllers (e. g. for temperature control)
- Recommended snubber network e. g. for $V_{VRMS} \leq 400$ V:
 $R = 33 \Omega / 32$ W, $C = 0,47 \mu F$

| V_{RSM} V | V_{RRM}, V_{DRM} V | $I_{TRMS} = 1000$ A (maximum value for continuous operation) $I_{TAV} = 490$ A (sin. 180; DSC; $T_c = 80$ °C) | |
|----------------|-------------------------|--|--|
| 500 | 400 | SKT 491/04E | |
| 1300 | 1200 | SKT 491/12E | |
| 1500 | 1400 | SKT 491/14E | |
| 1700 | 1600 | SKT 491/16E | |
| 1900 | 1800 | SKT 491/18E | |

| Symbol | Conditions | Values | Units |
|------------------|---|-------------------------|--------------------------------------|
| I_{TAV} | sin. 180; $T_c = 100$ (85) °C; | 321 (452) | A |
| I_D | 2 x P8/180; $T_a = 45$ °C; B2 / B6 2 x P8/180F; $T_a = 35$ °C; B2 / B6 | 320 / 450 760 / 1000 | A A |
| I_{RMS} | 2 x P8/180; $T_a = 45$ °C; W1C | 350 | A |
| I_{TSM} | $T_{vj} = 25$ °C; 10 ms $T_{vj} = 125$ °C; 10 ms | 8000 7000 | A A |
| i^2t | $T_{vj} = 25$ °C; 8,3 ... 10 ms $T_{vj} = 125$ °C; 8,3 ... 10 ms | 320000 245000 | A ² s A ² s |
| V_T | $T_{vj} = 25$ °C; $I_T = 1500$ A | max. 2,1 | V |
| $V_{T(TO)}$ | $T_{vj} = 125$ °C | max. 1,1 | V |
| r_T | $T_{vj} = 125$ °C | max. 0,7 | mΩ |
| I_{DD}, I_{RD} | $T_{vj} = 125$ °C; $V_{RD} = V_{RRM}; V_{DD} = V_{DRM}$ | max. 60 | mA |
| t_{gd} | $T_{vj} = 25$ °C; $I_G = 1$ A; $di_G/dt = 1$ A/μs | 1 | μs |
| t_{gr} | $V_D = 0,67 * V_{DRM}$ | 1 | μs |
| $(di/dt)_{cr}$ | $T_{vj} = 125$ °C | max. 125 | A/μs |
| $(dv/dt)_{cr}$ | $T_{vj} = 125$ °C | max. 1000 | V/μs |
| t_q | $T_{vj} = 125$ °C, | 50 ... 150 | μs |
| I_H | $T_{vj} = 25$ °C; typ. / max. | 150 / 500 | mA |
| I_L | $T_{vj} = 25$ °C; $R_G = 33 \Omega$; typ. / max. | 500 / 2000 | mA |
| V_{GT} | $T_{vj} = 25$ °C; d.c. | min. 3 | V |
| I_{GT} | $T_{vj} = 25$ °C; d.c. | min. 250 | mA |
| V_{GD} | $T_{vj} = 125$ °C; d.c. | max. 0,25 | V |
| I_{GD} | $T_{vj} = 125$ °C; d.c. | max. 10 | mA |
| $R_{th(j-c)}$ | cont.; DSC | 0,045 | K/W |
| $R_{th(j-c)}$ | sin. 180; DSC / SSC | 0,047 / 0,1 | K/W |
| $R_{th(j-c)}$ | rec. 120; DSC / SSC | 0,054 / 0,113 | K/W |
| $R_{th(c-s)}$ | DSC / SSC | 0,012 / 0,024 | K/W |
| T_{vj} | | - 40 ... + 125 | °C |
| T_{stg} | | - 40 ... + 130 | °C |
| V_{isol} | | - | V~ |
| F | mounting force | 5,2 ... 8 | kN |
| a | | | m/s ² |
| m | approx. | 105 | g |
| Case | | B 11 | |



SKT

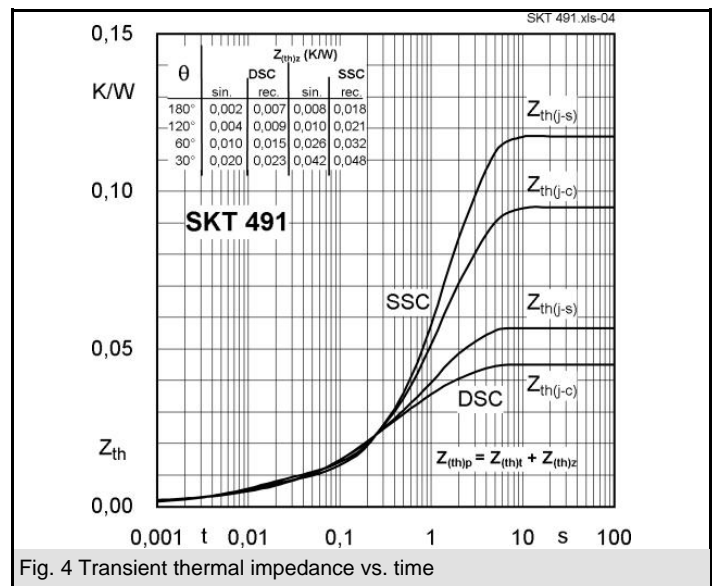
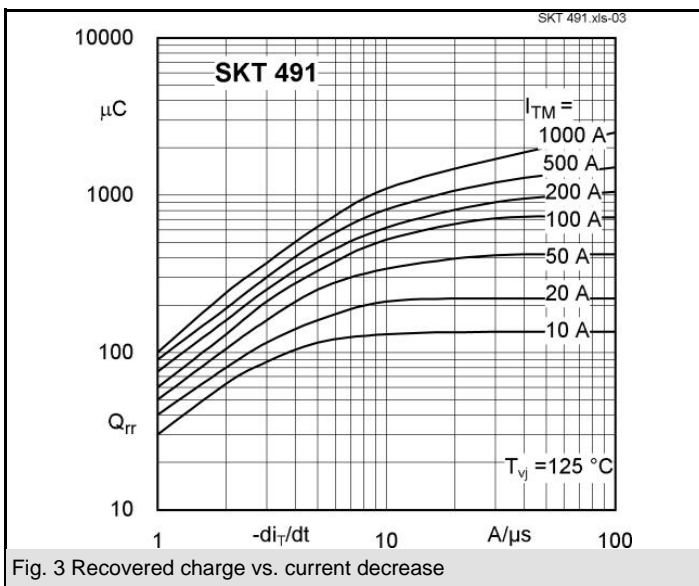
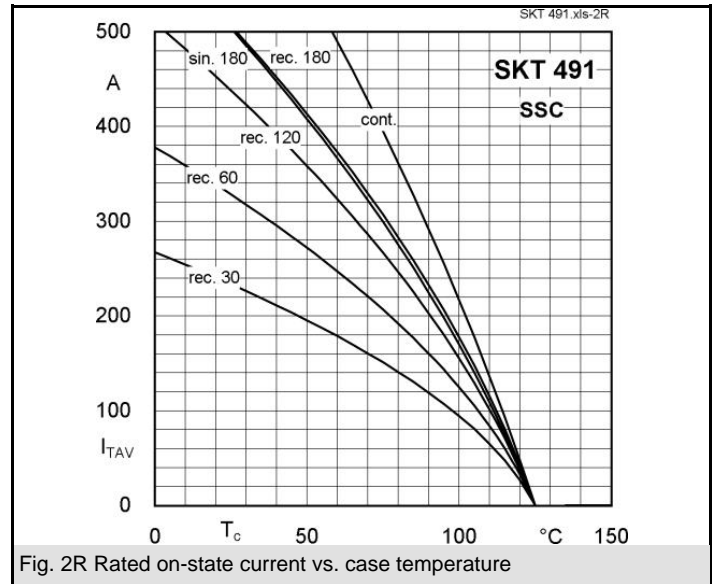
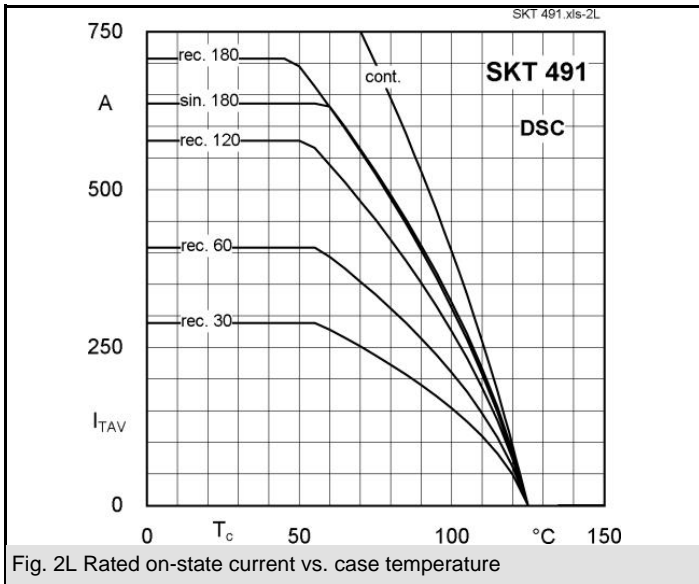
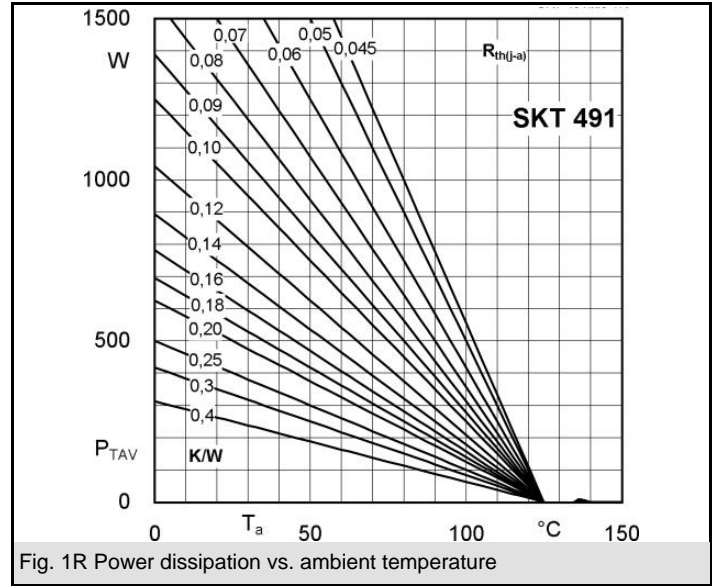
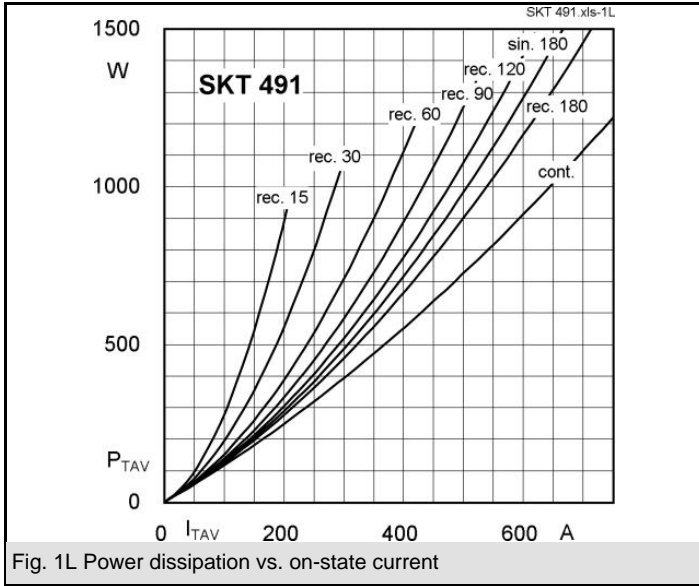

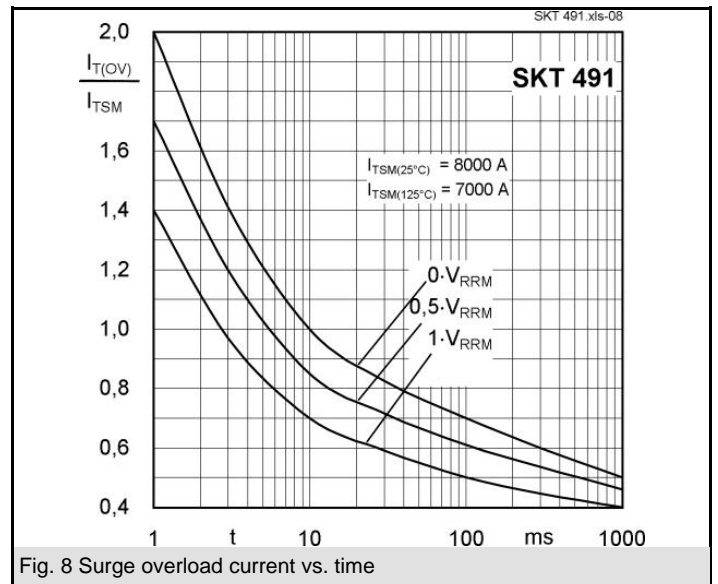
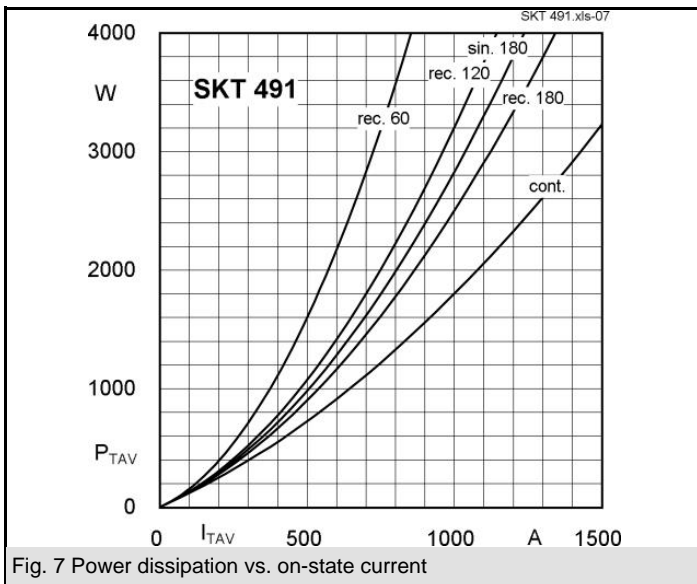
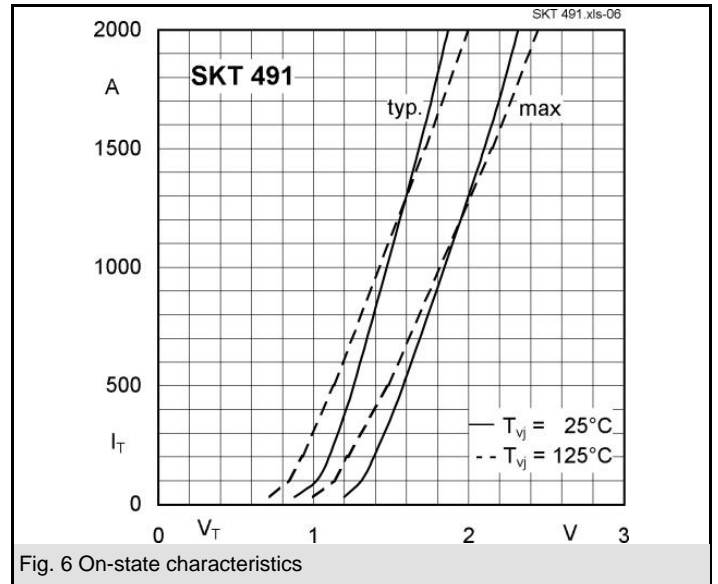
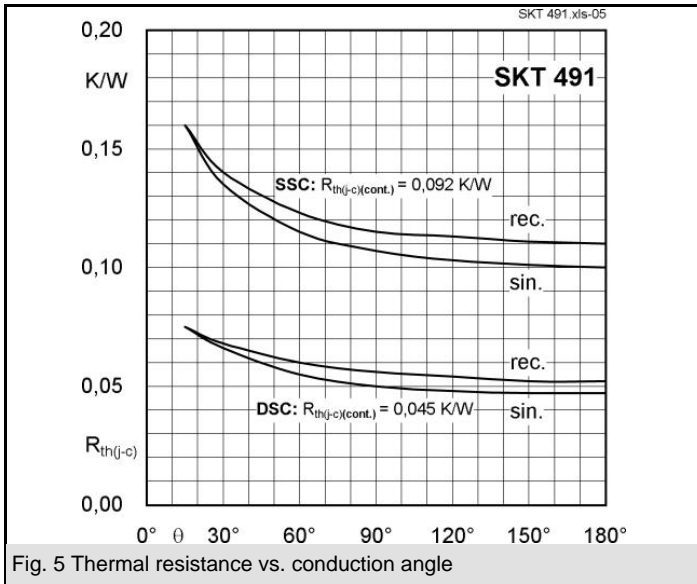

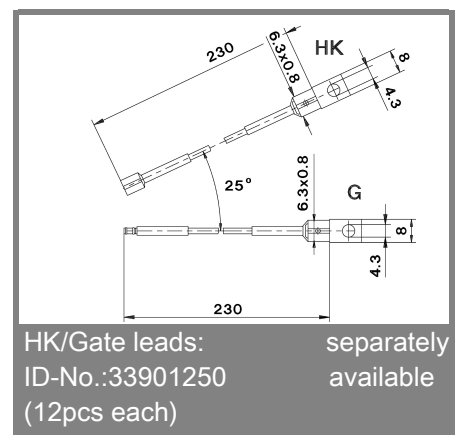
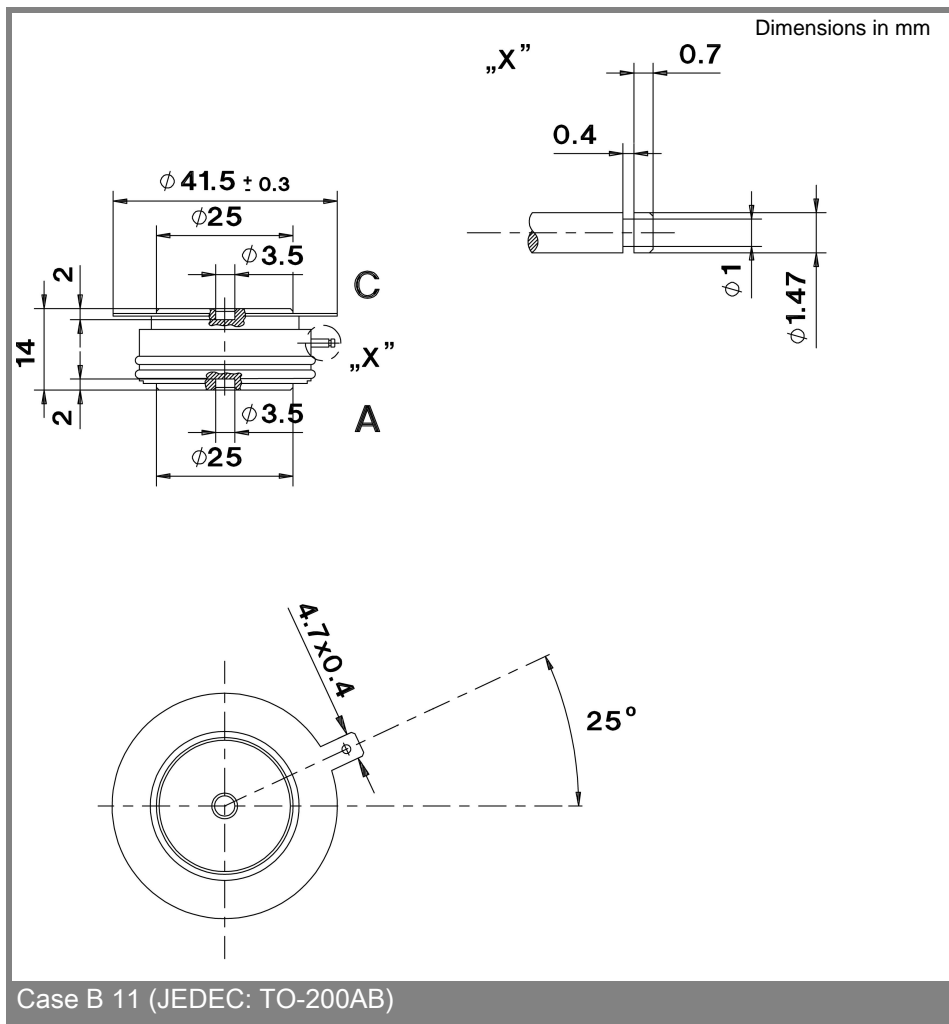
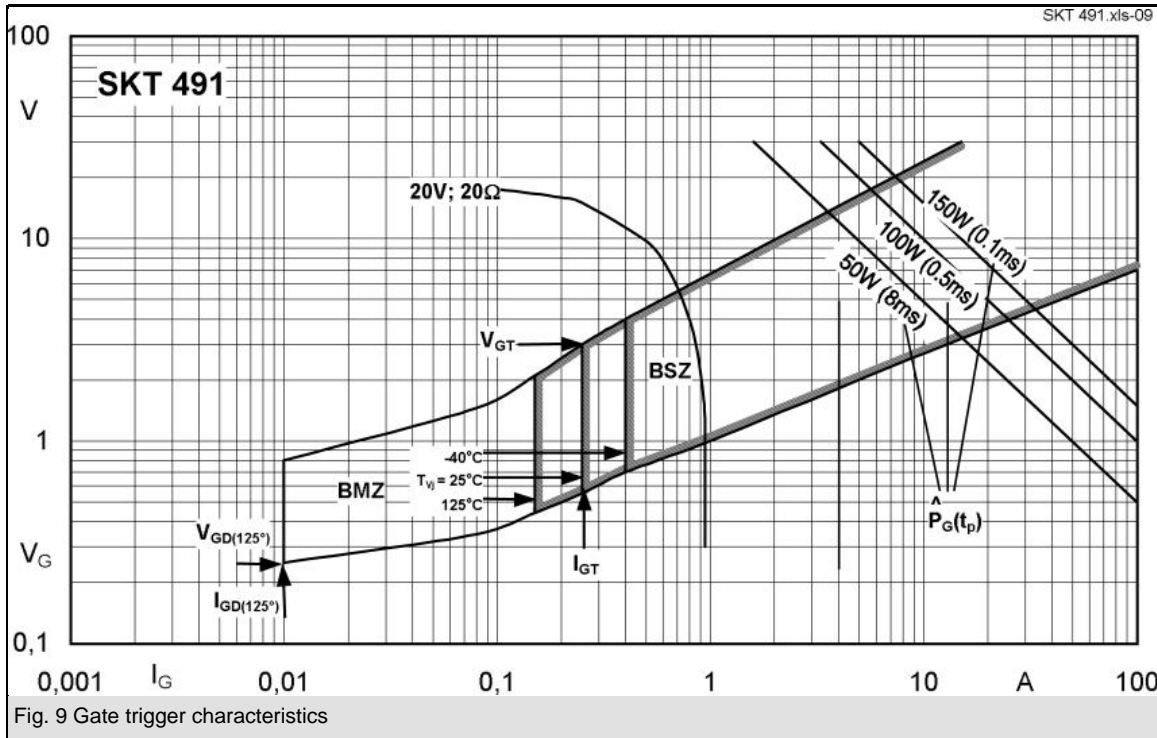

This technical information specifies semiconductor devices but promises no characteristics. No warranty or guarantee expressed or implied is made regarding delivery, performance or suitability.