

Stud Diode

Rectifier Diode

SKN 70

SKR 70

Features

- Reverse voltages up to 1600 V
- Hermetic metal case with glass insulator
- Threaded stud ISO M8
- SKN: anode to stud, SKR: cathode to stud

Typical Applications

- All-purpose mean power rectifier diodes
- Cooling via heatsinks
- Non-controllable and half-controllable rectifiers
- Free-wheeling diodes
- Recommended snubber network:
 $RC: 0,1 \mu F, 100 \Omega (P_R = 2 W)$
 $R_P = 80 k\Omega (P_R = 6 W)$

V_{RSM} V	V_{RRM} V	$I_{FRMS} = 150 A$ (maximum value for continuous operation) $I_{FAV} = 70 A$ (sin. 180; $T_c = 125^\circ C$)	
400	400	SKN 70/04	SKR 70/04
800	800	SKN 70/08	SKR 70/08
1200	1200	SKN 70/12	SKR 70/12
1400	1400	SKN 70/14	SKR 70/14
1600	1600	SKN 70/16	SKR 70/16

Symbol	Conditions	Values	Units
I_{FAV}	sin. 180; $T_c = 100^\circ C$	95	A
I_D	K 1,1; $T_a = 45^\circ C$; B2 / B6	112 / 159	A
	K 1,1F; $T_a = 35^\circ C$; B2 / B6	174 / 246	A
I_{FSM}	$T_{vj} = 25^\circ C$; 10 ms	1150	A
	$T_{vj} = 180^\circ C$; 10 ms	1000	A
i^2t	$T_{vj} = 25^\circ C$; 8,3 ... 10 ms	6600	A ² s
	$T_{vj} = 180^\circ C$; 8,3 ... 10 ms	5000	A ² s
V_F	$T_{vj} = 25^\circ C$; $I_F = 200 A$	max. 1,5	V
$V_{(TO)}$	$T_{vj} = 180^\circ C$	max. 0,85	V
r_T	$T_{vj} = 180^\circ C$	max. 3	m Ω
I_{RD}	$T_{vj} = 180^\circ C$; $V_{RD} = V_{RRM}$	max. 10	mA
Q_{rr}	$T_{vj} = 160^\circ C$; $- di_F/dt = 10 A/\mu s$	70	μC
$R_{th(j-c)}$		0,55	K/W
$R_{th(c-s)}$		0,2	K/W
T_{vj}		- 40 ... + 180	$^\circ C$
T_{stg}		- 55 ... + 180	$^\circ C$
V_{isol}		-	V~
M_s	to heatsink	4	Nm
a		5 * 9,81	m/s ²
m	approx.	30	g
Case		E 12	

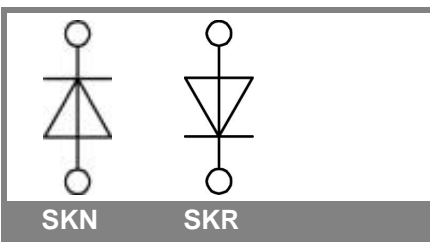

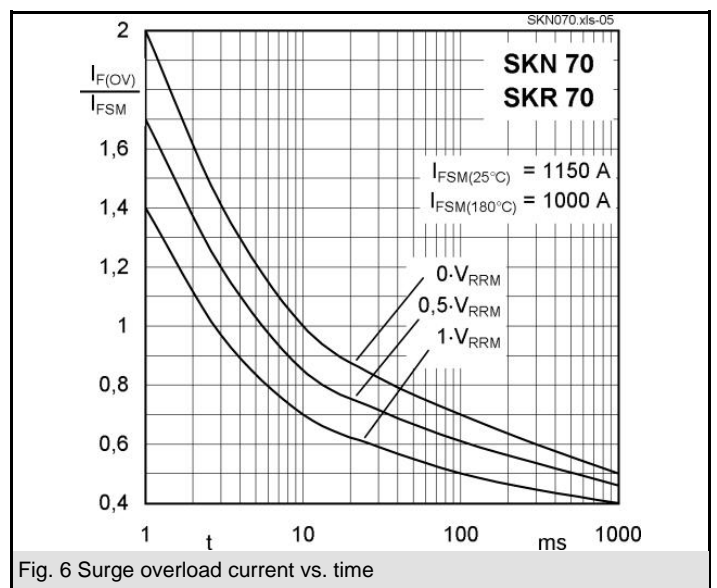
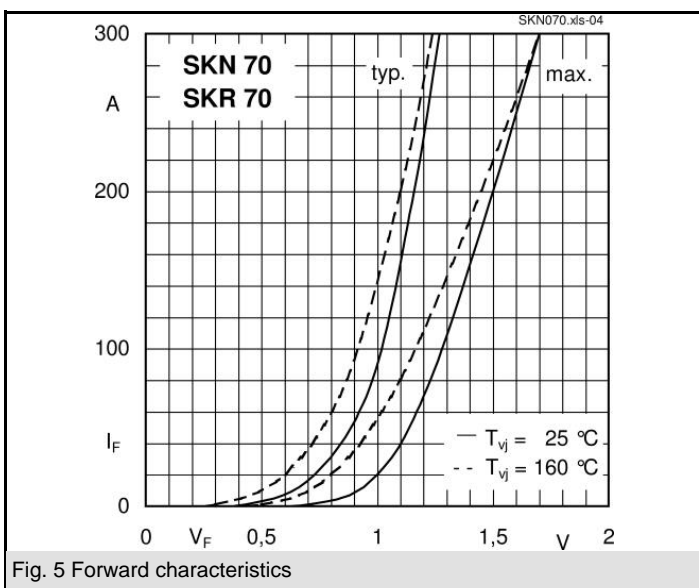
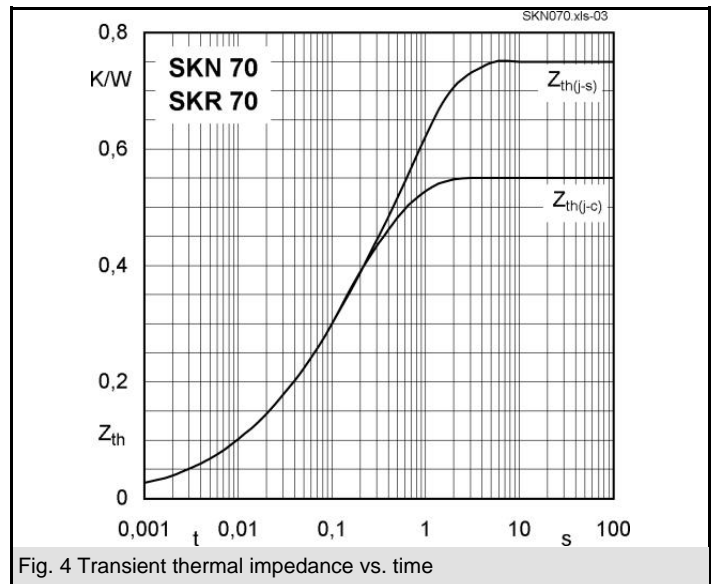
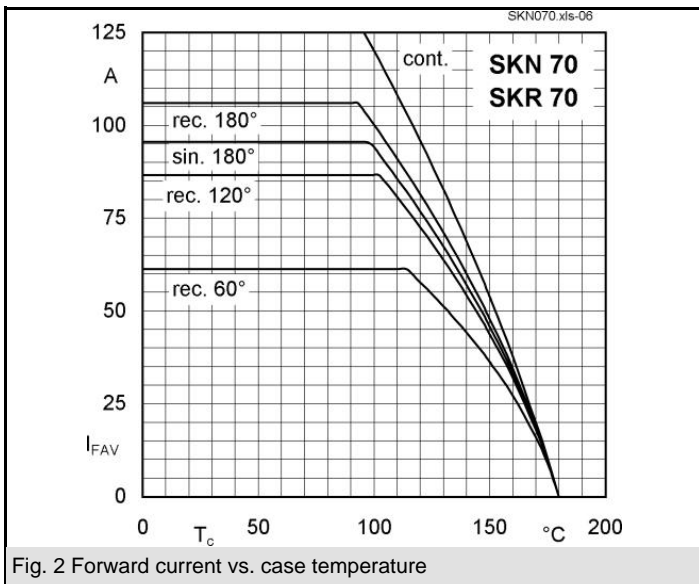
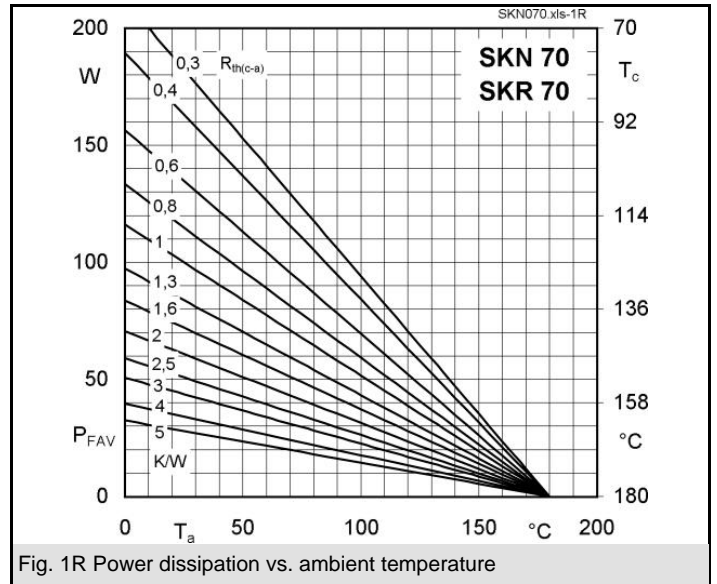
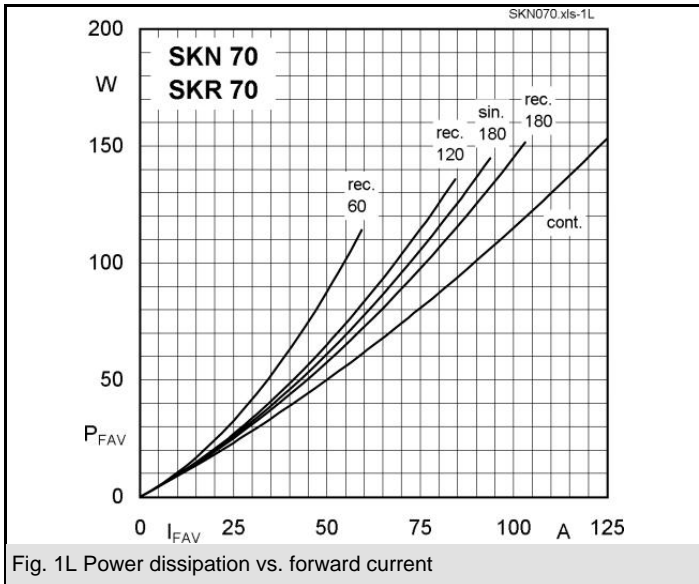

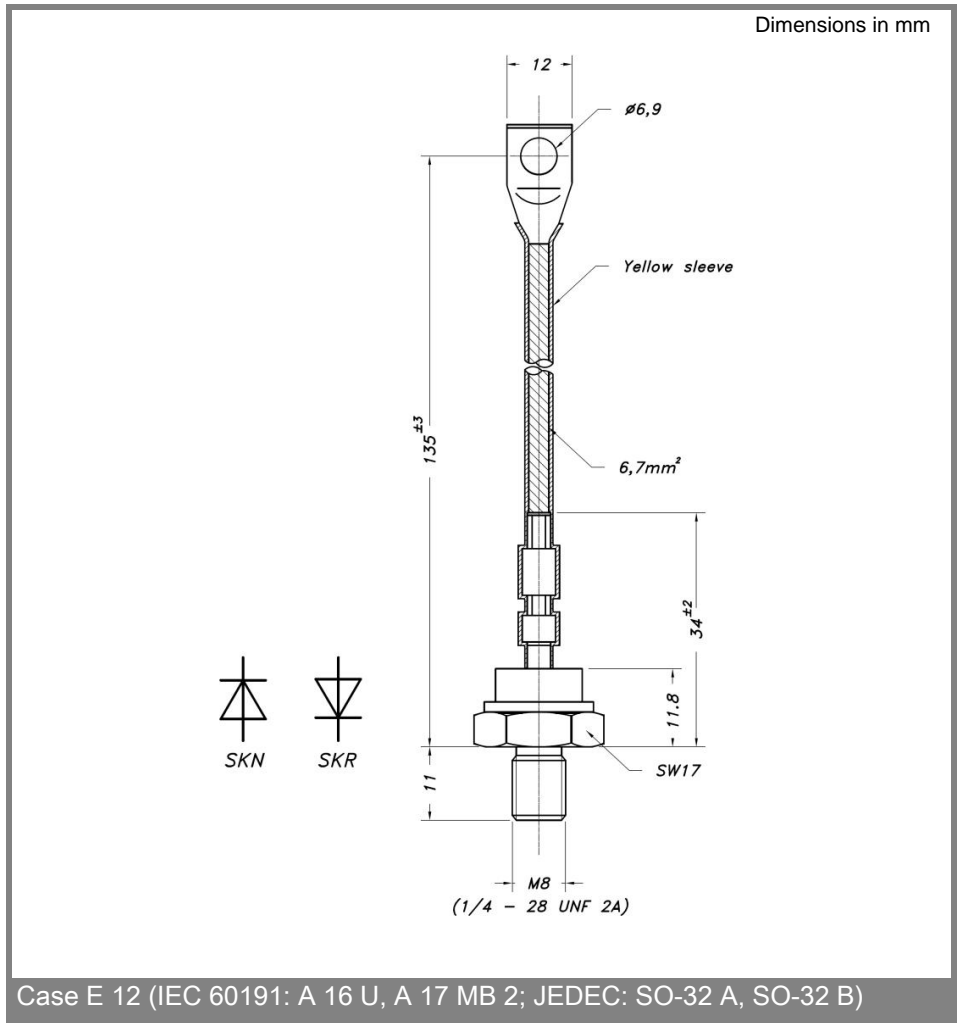

This technical information specifies semiconductor devices but promises no characteristics. No warranty or guarantee expressed or implied is made regarding delivery, performance or suitability.