

# 24-Bit 2-/4-Channel $\Delta\Sigma$ ADC with Easy Drive Input Current Cancellation

## FEATURES

- Up to 2 Differential or 4 Single-Ended Inputs
- Easy Drive Technology Enables Rail-to-Rail Inputs with Zero Differential Input Current
- Directly Digitizes High Impedance Sensors with Full Accuracy
- 600nV RMS Noise
- Integrated High Accuracy Temperature Sensor
- GND to  $V_{CC}$  Input/Reference Common Mode Range
- Programmable 50Hz, 60Hz, or Simultaneous 50Hz/60Hz Rejection Mode
- 2ppm INL, No Missing Codes
- 1ppm Offset and 15ppm Full-Scale Error
- 2x Speed Mode/Reduced Power Mode (15Hz Using Internal Oscillator and 80 $\mu$ A at 7.5Hz Output)
- No Latency: Digital Filter Settles in a Single Cycle, Even After a New Channel is Selected
- Single Supply 2.7V to 5.5V Operation (0.8mW)
- Internal Oscillator
- Tiny DFN 4mm  $\times$  3mm Package

## APPLICATIONS

- Direct Sensor Digitizer
- Direct Temperature Measurement
- Instrumentation
- Industrial Process Control

## DESCRIPTION

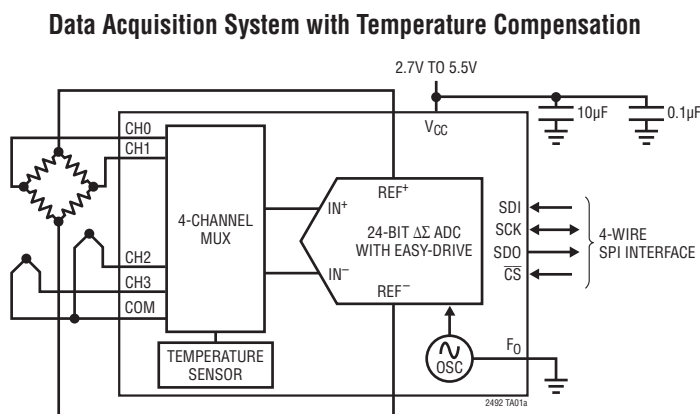
The LTC<sup>®</sup>2492 is a 4-channel (2-channel differential), 24-bit, No Latency  $\Delta\Sigma$ <sup>™</sup> ADC with Easy Drive<sup>™</sup> technology. The patented sampling scheme eliminates dynamic input current errors and the shortcomings of on-chip buffering through automatic cancellation of differential input current. This allows large external source impedances and rail-to-rail input signals to be directly digitized while maintaining exceptional DC accuracy.

The LTC2492 includes a high accuracy temperature sensor and an integrated oscillator. This device can be configured to measure an external signal (from combinations of 4 analog input channels operating in single-ended or differential modes) or its internal temperature sensor. It can be programmed to reject line frequencies of 50Hz, 60Hz, or simultaneous 50Hz/60Hz and configured to double its output rate. The integrated temperature sensor offers 1/30th  $^{\circ}$ C resolution and 2 $^{\circ}$ C absolute accuracy.

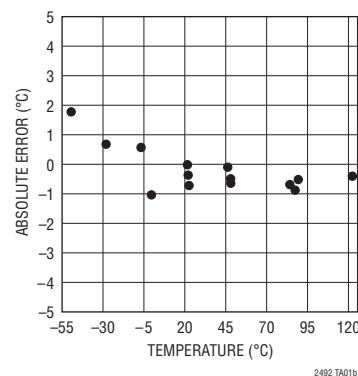
The LTC2492 allows a wide common mode input range (0V to  $V_{CC}$ ), independent of the reference voltage. Any combination of single-ended or differential inputs can be selected and the first conversion after a new channel selection is valid.

LT, LT, LTC and LTM are registered trademarks of Linear Technology Corporation. No Latency  $\Delta\Sigma$  and Easy Drive are trademarks of Linear Technology Corporation. All other trademarks are the property of their respective owners.

## TYPICAL APPLICATION



**Absolute Temperature Error**

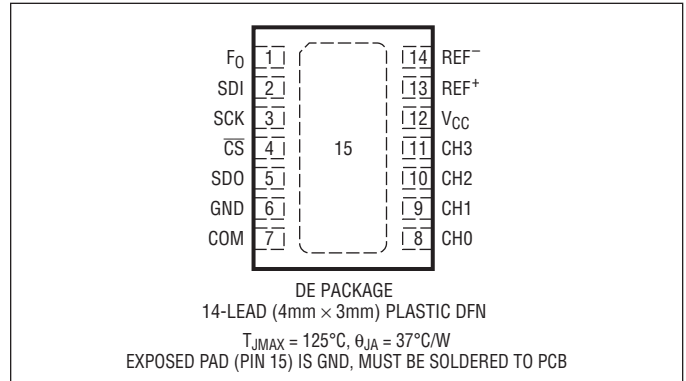


## ABSOLUTE MAXIMUM RATINGS

(Notes 1, 2)

Supply Voltage ( $V_{CC}$ )	-0.3V to 6V
Analog Input Voltage (CH0 to CH3, COM)	-0.3V to ( $V_{CC} + 0.3V$ )
REF <sup>+</sup> , REF <sup>-</sup>	-0.3V to ( $V_{CC} + 0.3V$ )
Digital Input Voltage	-0.3V to ( $V_{CC} + 0.3V$ )
Digital Output Voltage	-0.3V to ( $V_{CC} + 0.3V$ )
Operating Temperature Range	
LTC2492C	0°C to 70°C
LTC2492I	-40°C to 85°C
Storage Temperature Range	-65°C to 150°C

## PIN CONFIGURATION



## ORDER INFORMATION

LEAD FREE FINISH	TAPE AND REEL	PART MARKING*	PACKAGE DESCRIPTION	TEMPERATURE RANGE
LTC2492CDE#PBF	LTC2492CDE#TRPBF	2492	14-Lead (4mm × 3mm) Plastic DFN	0°C to 70°C
LTC2492IDE#PBF	LTC2492IDE#TRPBF	2492	14-Lead (4mm × 3mm) Plastic DFN	-40°C to 85°C

Consult LTC Marketing for parts specified with wider operating temperature ranges. \*The temperature grade is identified by a label on the shipping container. Consult LTC Marketing for information on non-standard lead based finish parts.

For more information on lead free part marking, go to: <http://www.linear.com/leadfree/>

For more information on tape and reel specifications, go to: <http://www.linear.com/tapeandreeel/>

## ELECTRICAL CHARACTERISTICS (NORMAL SPEED)

The ● denotes the specifications which apply over the full operating temperature range, otherwise specifications are at  $T_A = 25^\circ\text{C}$ . (Notes 3, 4)

PARAMETER	CONDITIONS	MIN	TYP	MAX	UNITS
Resolution (No Missing Codes)	$0.1V \leq V_{REF} \leq V_{CC}$ , $-FS \leq V_{IN} \leq +FS$ (Note 5)	24			Bits
Integral Nonlinearity	$5V \leq V_{CC} \leq 5.5V$ , $V_{REF} = 5V$ , $V_{IN(CM)} = 2.5V$ (Note 6) $2.7V \leq V_{CC} \leq 5.5V$ , $V_{REF} = 2.5V$ , $V_{IN(CM)} = 1.25V$ (Note 6)	●	2 1	10	ppm of $V_{REF}$ ppm of $V_{REF}$
Offset Error	$2.5V \leq V_{REF} \leq V_{CC}$ , $GND \leq IN^+ = IN^- \leq V_{CC}$ (Note 14)	●	0.5	2.5	$\mu\text{V}$
Offset Error Drift	$2.5V \leq V_{REF} \leq V_{CC}$ , $GND \leq IN^+ = IN^- \leq V_{CC}$		10		nV/°C
Positive Full-Scale Error	$2.5V \leq V_{REF} \leq V_{CC}$ , $IN^+ = 0.75V_{REF}$ , $IN^- = 0.25V_{REF}$	●		25	ppm of $V_{REF}$
Positive Full-Scale Error Drift	$2.5V \leq V_{REF} \leq V_{CC}$ , $IN^+ = 0.75V_{REF}$ , $IN^- = 0.25V_{REF}$		0.1		ppm of $V_{REF}/^\circ\text{C}$
Negative Full-Scale Error	$2.5V \leq V_{REF} \leq V_{CC}$ , $IN^+ = 0.25V_{REF}$ , $IN^- = 0.75V_{REF}$	●		25	ppm of $V_{REF}$
Negative Full-Scale Error Drift	$2.5V \leq V_{REF} \leq V_{CC}$ , $IN^+ = 0.25V_{REF}$ , $IN^- = 0.75V_{REF}$		0.1		ppm of $V_{REF}/^\circ\text{C}$
Total Unadjusted Error	$5V \leq V_{CC} \leq 5.5V$ , $V_{REF} = 2.5V$ , $V_{IN(CM)} = 1.25V$ $5V \leq V_{CC} \leq 5.5V$ , $V_{REF} = 5V$ , $V_{IN(CM)} = 2.5V$ $2.7V \leq V_{CC} \leq 5.5V$ , $V_{REF} = 2.5V$ , $V_{IN(CM)} = 1.25V$		15 15 15		ppm of $V_{REF}$ ppm of $V_{REF}$ ppm of $V_{REF}$
Output Noise	$5.5V < V_{CC} < 2.7V$ , $2.5V \leq V_{REF} \leq V_{CC}$ , $GND \leq IN^+ = IN^- \leq V_{CC}$ (Note 13)		0.6		$\mu\text{V}_{RMS}$
Internal PTAT Signal	$T_A = 27^\circ\text{C}$ (Note 14)	27.8	28.0	28.2	mV
Internal PTAT Temperature Coefficient			93.5		$\mu\text{V}/^\circ\text{C}$

## ELECTRICAL CHARACTERISTICS (2X SPEED)

The ● denotes the specifications which apply over the full operating temperature range, otherwise specifications are at  $T_A = 25^\circ\text{C}$ . (Notes 3, 4)

PARAMETER	CONDITIONS	MIN	TYP	MAX	UNITS
Resolution (No Missing Codes)	$0.1V \leq V_{REF} \leq V_{CC}$ , $-FS \leq V_{IN} \leq +FS$ (Note 5)	24			Bits
Integral Nonlinearity	$5V \leq V_{CC} \leq 5.5V$ , $V_{REF} = 5V$ , $V_{IN(CM)} = 2.5V$ (Note 6)	●	2	10	ppm of $V_{REF}$
	$2.7V \leq V_{CC} \leq 5.5V$ , $V_{REF} = 2.5V$ , $V_{IN(CM)} = 1.2V$ (Note 6)	●	1		ppm of $V_{REF}$
Offset Error	$2.5V \leq V_{REF} \leq V_{CC}$ , $GND \leq IN^+ = IN^- \leq V_{CC}$ (Note 14)	●	0.2	2	mV
Offset Error Drift	$2.5V \leq V_{REF} \leq V_{CC}$ , $GND \leq IN^+ = IN^- \leq V_{CC}$		100		nV/ $^\circ\text{C}$
Positive Full-Scale Error	$2.5V \leq V_{REF} \leq V_{CC}$ , $IN^+ = 0.75V_{REF}$ , $IN^- = 0.25V_{REF}$	●		25	ppm of $V_{REF}$
Positive Full-Scale Error Drift	$2.5V \leq V_{REF} \leq V_{CC}$ , $IN^+ = 0.75V_{REF}$ , $IN^- = 0.25V_{REF}$		0.1		ppm of $V_{REF}/^\circ\text{C}$
Negative Full-Scale Error	$2.5V \leq V_{REF} \leq V_{CC}$ , $IN^+ = 0.25V_{REF}$ , $IN^- = 0.75V_{REF}$	●		25	ppm of $V_{REF}$
Negative Full-Scale Error Drift	$2.5V \leq V_{REF} \leq V_{CC}$ , $IN^+ = 0.25V_{REF}$ , $IN^- = 0.75V_{REF}$		0.1		ppm of $V_{REF}/^\circ\text{C}$
Output Noise	$5V \leq V_{CC} \leq 5.5V$ , $V_{REF} = 5V$ , $GND \leq IN^+ = IN^- \leq V_{CC}$		0.85		$\mu\text{V}_{RMS}$

## CONVERTER CHARACTERISTICS

The ● denotes the specifications which apply over the full operating temperature range, otherwise specifications are at  $T_A = 25^\circ\text{C}$ . (Note 3)

PARAMETER	CONDITIONS	MIN	TYP	MAX	UNITS
Input Common Mode Rejection DC	$2.5V \leq V_{REF} \leq V_{CC}$ , $GND \leq IN^+ = IN^- \leq V_{CC}$ (Note 5)	●	140		dB
Input Common Mode Rejection 50Hz $\pm 2\%$	$2.5V \leq V_{REF} \leq V_{CC}$ , $GND \leq IN^+ = IN^- \leq V_{CC}$ (Note 5)	●	140		dB
Input Common Mode Rejection 60Hz $\pm 2\%$	$2.5V \leq V_{REF} \leq V_{CC}$ , $GND \leq IN^+ = IN^- \leq V_{CC}$ (Note 5)	●	140		dB
Input Normal Mode Rejection 50Hz $\pm 2\%$	$2.5V \leq V_{REF} \leq V_{CC}$ , $GND \leq IN^+ = IN^- \leq V_{CC}$ (Notes 5, 7)	●	110	120	dB
Input Normal Mode Rejection 60Hz $\pm 2\%$	$2.5V \leq V_{REF} \leq V_{CC}$ , $GND \leq IN^+ = IN^- \leq V_{CC}$ (Notes 5, 8)	●	110	120	dB
Input Normal Mode Rejection 50Hz/60Hz $\pm 2\%$	$2.5V \leq V_{REF} \leq V_{CC}$ , $GND \leq IN^+ = IN^- \leq V_{CC}$ (Notes 5, 9)	●	87		dB
Reference Common Mode Rejection DC	$2.5V \leq V_{REF} \leq V_{CC}$ , $GND \leq IN^+ = IN^- \leq V_{CC}$ (Note 5)	●	120	140	dB
Power Supply Rejection DC	$V_{REF} = 2.5V$ , $IN^+ = IN^- = GND$		120		dB
Power Supply Rejection, 50Hz $\pm 2\%$	$V_{REF} = 2.5V$ , $IN^+ = IN^- = GND$ (Notes 7, 9)		120		dB
Power Supply Rejection, 60Hz $\pm 2\%$	$V_{REF} = 2.5V$ , $IN^+ = IN^- = GND$ (Notes 8, 9)		120		dB

## ANALOG INPUT AND REFERENCE

The ● denotes the specifications which apply over the full operating temperature range, otherwise specifications are at  $T_A = 25^\circ\text{C}$ . (Note 3)

SYMBOL	PARAMETER	CONDITIONS	MIN	TYP	MAX	UNITS	
IN <sup>+</sup>	Absolute/Common Mode IN <sup>+</sup> Voltage (IN <sup>+</sup> Corresponds to the Selected Positive Input Channel)		GND – 0.3V		V <sub>CC</sub> + 0.3V	V	
IN <sup>-</sup>	Absolute/Common Mode IN <sup>-</sup> Voltage (IN <sup>-</sup> Corresponds to the Selected Negative Input Channel)		GND – 0.3V		V <sub>CC</sub> + 0.3V	V	
V <sub>IN</sub>	Input Differential Voltage Range (IN <sup>+</sup> – IN <sup>-</sup> )	●	–FS		+FS	V	
FS	Full Scale of the Differential Input (IN <sup>+</sup> – IN <sup>-</sup> )	●	0.5V <sub>REF</sub>			V	
LSB	Least Significant Bit of the Output Code	●	FS/2 <sup>24</sup>				
REF <sup>+</sup>	Absolute/Common Mode REF <sup>+</sup> Voltage	●	0.1		V <sub>CC</sub>	V	
REF <sup>-</sup>	Absolute/Common Mode REF <sup>-</sup> Voltage	●	GND		REF <sup>+</sup> – 0.1V	V	
V <sub>REF</sub>	Reference Voltage Range (REF <sup>+</sup> – REF <sup>-</sup> )	●	0.1		V <sub>CC</sub>	V	
CS(IN <sup>+</sup> )	IN <sup>+</sup> Sampling Capacitance			11		pF	
CS(IN <sup>-</sup> )	IN <sup>-</sup> Sampling Capacitance			11		pF	
CS(V <sub>REF</sub> )	V <sub>REF</sub> Sampling Capacitance			11		pF	
I <sub>DC_LEAK(IN<sup>+</sup>)</sub>	IN <sup>+</sup> DC Leakage Current	Sleep Mode, IN <sup>+</sup> = GND	●	–10	1	10	nA
I <sub>DC_LEAK(IN<sup>-</sup>)</sub>	IN <sup>-</sup> DC Leakage Current	Sleep Mode, IN <sup>-</sup> = GND	●	–10	1	10	nA
I <sub>DC_LEAK(REF<sup>+</sup>)</sub>	REF <sup>+</sup> DC Leakage Current	Sleep Mode, REF <sup>+</sup> = V <sub>CC</sub>	●	–100	1	100	nA
I <sub>DC_LEAK(REF<sup>-</sup>)</sub>	REF <sup>-</sup> DC Leakage Current	Sleep Mode, REF <sup>-</sup> = GND	●	–100	1	100	nA
t <sub>OPEN</sub>	MUX Break-Before-Make			50		ns	
QIRR	MUX Off Isolation	V <sub>IN</sub> = 2V <sub>P-P</sub> DC to 1.8MHz		120		dB	

## DIGITAL INPUTS AND DIGITAL OUTPUTS

The ● denotes the specifications which apply over the full operating temperature range, otherwise specifications are at  $T_A = 25^\circ\text{C}$ . (Note 3)

SYMBOL	PARAMETER	CONDITIONS	MIN	TYP	MAX	UNITS
V <sub>IH</sub>	High Level Input Voltage (C <sup>+</sup> S, F <sub>0</sub> , SDI)	2.7V ≤ V <sub>CC</sub> ≤ 5.5V	●	V <sub>CC</sub> – 0.5		V
V <sub>IL</sub>	Low Level Input Voltage (C <sup>+</sup> S, F <sub>0</sub> , SDI)	2.7V ≤ V <sub>CC</sub> ≤ 5.5V	●		0.5	V
V <sub>IH</sub>	High Level Input Voltage (SCK)	2.7V ≤ V <sub>CC</sub> ≤ 5.5V (Notes 10, 15)	●	V <sub>CC</sub> – 0.5		V
V <sub>IL</sub>	Low Level Input Voltage (SCK)	2.7V ≤ V <sub>CC</sub> ≤ 5.5V (Notes 10, 15)	●		0.5	V
I <sub>IN</sub>	Digital Input Current (C <sup>+</sup> S, F <sub>0</sub> , SDI)	0V ≤ V <sub>IN</sub> ≤ V <sub>CC</sub>	●	–10	10	μA
I <sub>IN</sub>	Digital Input Current (SCK)	0V ≤ V <sub>IN</sub> ≤ V <sub>CC</sub> (Notes 10, 15)	●	–10	10	μA
C <sub>IN</sub>	Digital Input Capacitance (C <sup>+</sup> S, F <sub>0</sub> , SDI)			10		pF
C <sub>IN</sub>	Digital Input Capacitance (SCK)	(Notes 10, 15)		10		pF
V <sub>OH</sub>	High Level Output Voltage (SDO)	I <sub>O</sub> = –800μA	●	V <sub>CC</sub> – 0.5		V
V <sub>OL</sub>	Low Level Output Voltage (SDO)	I <sub>O</sub> = 1.6mA	●		0.4	V
V <sub>OH</sub>	High Level Output Voltage (SCK)	I <sub>O</sub> = –800μA (Notes 10, 17)	●	V <sub>CC</sub> – 0.5		V
V <sub>OL</sub>	Low Level Output Voltage (SCK)	I <sub>O</sub> = 1.6mA (Notes 10, 17)	●		0.4	V
I <sub>OZ</sub>	Hi-Z Output Leakage (SDO)		●	–10	10	μA

## POWER REQUIREMENTS

The ● denotes the specifications which apply over the full operating temperature range, otherwise specifications are at  $T_A = 25^\circ\text{C}$ . (Note 3)

SYMBOL	PARAMETER	CONDITIONS	MIN	TYP	MAX	UNITS
V <sub>CC</sub>	Supply Voltage		●	2.7	5.5	V
I <sub>CC</sub>	Supply Current	Conversion Current (Note 12)	●	160	275	μA
		Temperature Measurement (Note 12)	●	200	300	μA
		Sleep Mode (Note 12)	●	1	2	μA

## DIGITAL INPUTS AND DIGITAL OUTPUTS

The ● denotes the specifications which apply over the full operating temperature range, otherwise specifications are at  $T_A = 25^\circ\text{C}$ . (Note 3)

SYMBOL	PARAMETER	CONDITIONS	MIN	TYP	MAX	UNITS
$f_{\text{EOSC}}$	External Oscillator Frequency Range	(Note 16)	● 10		4000	kHz
$t_{\text{HEO}}$	External Oscillator High Period		● 0.125		100	$\mu\text{s}$
$t_{\text{LEO}}$	External Oscillator Low Period		● 0.125		100	$\mu\text{s}$
$t_{\text{CONV}_1}$	Conversion Time for 1x Speed Mode	50Hz Mode 60Hz Mode Simultaneous 50/60Hz Mode External Oscillator	● 157.2 ● 131 ● 144.1	160.3 133.6 146.9 41036/ $f_{\text{EOSC}}$ (in kHz)	163.5 136.3 149.9	ms ms ms ms
$t_{\text{CONV}_2}$	Conversion Time for 2x Speed Mode	50Hz Mode 60Hz Mode Simultaneous 50/60Hz Mode External Oscillator	● 78.7 ● 65.6 ● 72.2	80.3 66.9 73.6 20556/ $f_{\text{EOSC}}$ (in kHz)	81.9 68.2 75.1	ms ms ms ms
$f_{\text{ISCK}}$	Internal SCK Frequency	Internal Oscillator (Notes 10, 17) External Oscillator (Notes 10, 11, 15)		38.4 $f_{\text{EOSC}}/8$		kHz kHz
$D_{\text{ISCK}}$	Internal SCK Duty Cycle	(Notes 10, 17)	● 45		55	%
$f_{\text{ESCK}}$	External SCK Frequency Range	(Notes 10, 11, 15)	●		4000	kHz
$t_{\text{LESCK}}$	External SCK Low Period	(Notes 10, 11, 15)	● 125			ns
$t_{\text{HESCK}}$	External SCK High Period	(Notes 10, 11, 15)	● 125			ns
$t_{\text{DOUT\_ISCK}}$	Internal SCK 32-Bit Data Output Time	Internal Oscillator (Notes 10, 17) External Oscillator (Notes 10, 11, 15)	● 0.81	0.83 256/ $f_{\text{EOSC}}$ (in kHz)	0.85	ms ms
$t_{\text{DOUT\_ESCK}}$	External SCK 32-Bit Data Output Time	(Notes 10, 11, 15)		32/ $f_{\text{ESCK}}$ (in kHz)		ms
$t_1$	$\overline{\text{CS}}\downarrow$ to SDO Low		● 0		200	ns
$t_2$	$\overline{\text{CS}}\uparrow$ to SDO Hi-Z		● 0		200	ns
$t_3$	$\overline{\text{CS}}\downarrow$ to SCK $\downarrow$	Internal SCK Mode	● 0		200	ns
$t_4$	$\overline{\text{CS}}\downarrow$ to SCK $\uparrow$	External SCK Mode	● 50			ns
$t_{\text{KQMAX}}$	SCK $\downarrow$ to SDO Valid		●		200	ns
$t_{\text{KQMIN}}$	SDO Hold After SCK $\downarrow$	(Note 5)	● 15			ns
$t_5$	SCK Set-Up Before $\overline{\text{CS}}\downarrow$		● 50			ns
$t_7$	SDI Setup Before SCK $\uparrow$	(Note 5)	● 100			ns
$t_8$	SDI Hold After SCK $\uparrow$	(Note 5)	● 100			ns

**Note 1:** Stresses beyond those listed under Absolute Maximum Ratings may cause permanent damage to the device. Exposure to any Absolute Maximum Rating condition for extended periods may affect device reliability and lifetime.

**Note 2:** All voltage values are with respect to GND.

**Note 3:** Unless otherwise specified:

$$V_{\text{CC}} = 2.7\text{V to } 5.5\text{V}$$

$$V_{\text{REFCM}} = V_{\text{REF}}/2, F_{\text{S}} = 0.5V_{\text{REF}}$$

$$V_{\text{IN}} = \text{IN}^+ - \text{IN}^-, V_{\text{IN(CM)}} = (\text{IN}^+ + \text{IN}^-)/2,$$

where  $\text{IN}^+$  and  $\text{IN}^-$  are the selected input channels.

**Note 4:** Use internal conversion clock or external conversion clock source with  $f_{\text{EOSC}} = 307.2\text{kHz}$  unless otherwise specified.

**Note 5:** Guaranteed by design, not subject to test.

**Note 6:** Integral nonlinearity is defined as the deviation of a code from a straight line passing through the actual endpoints of the transfer curve. The deviation is measured from the center of the quantization band.

**Note 7:** 50Hz mode (internal oscillator) or  $f_{\text{EOSC}} = 256\text{kHz} \pm 2\%$  (external oscillator).

**Note 8:** 60Hz mode (internal oscillator) or  $f_{\text{EOSC}} = 307.2\text{kHz} \pm 2\%$  (external oscillator).

**Note 9:** Simultaneous 50Hz/60Hz mode (internal oscillator) or  $f_{\text{EOSC}} = 280\text{kHz} \pm 2\%$  (external oscillator).

**Note 10:** The SCK can be configured in external SCK mode or internal SCK mode. In external SCK mode, the SCK pin is used as a digital input and the driving clock is  $f_{\text{ESCK}}$ . In the internal SCK mode, the SCK pin is used as a digital output and the output clock signal during the data output is  $f_{\text{ISCK}}$ .

**Note 11:** The external oscillator is connected to the  $F_0$  pin. The external oscillator frequency,  $f_{\text{EOSC}}$ , is expressed in kHz.

**Note 12:** The converter uses its internal oscillator.

**Note 13:** The output noise includes the contribution of the internal calibration operations.

**Note 14:** Guaranteed by design and test correlation.

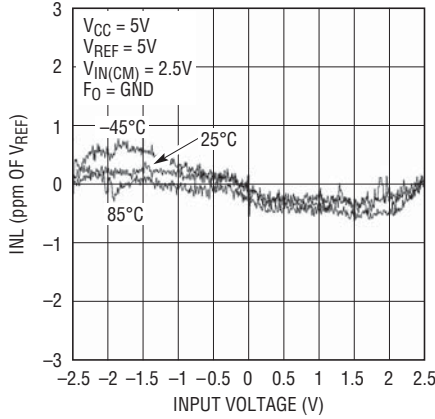
**Note 15:** The converter is in external SCK mode of operation such that the SCK pin is used as a digital input. The frequency of the clock signal driving SCK during the data output is  $f_{\text{ESCK}}$  and is expressed in Hz.

**Note 16:** Refer to Applications Information section for performance vs data rate graphs.

**Note 17:** The converter in internal SCK mode of operation such that the SCK pin is used as a digital output.

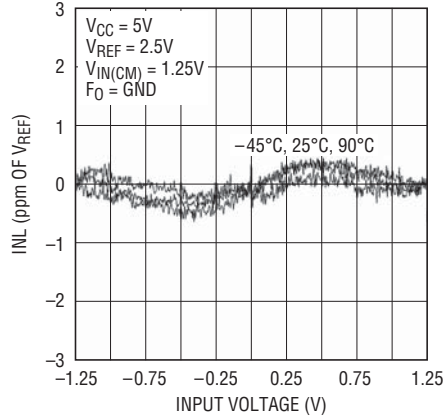
TYPICAL PERFORMANCE CHARACTERISTICS

**Integral Nonlinearity**  
( $V_{CC} = 5V$ ,  $V_{REF} = 5V$ )



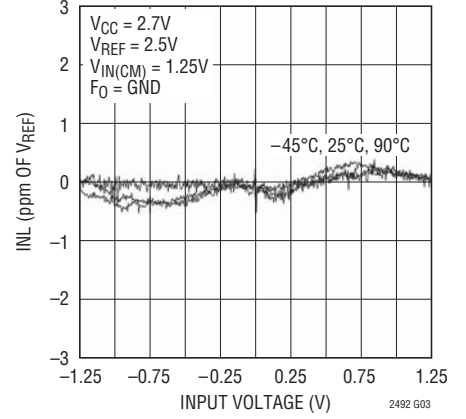
2492 G01

**Integral Nonlinearity**  
( $V_{CC} = 5V$ ,  $V_{REF} = 2.5V$ )



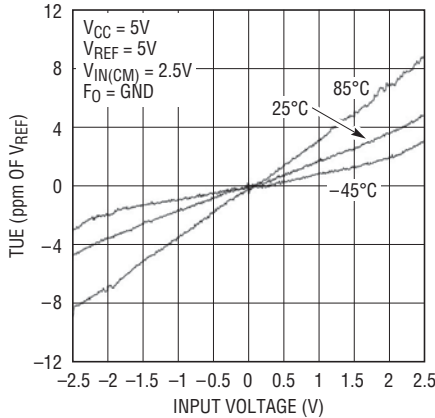
2492 G02

**Integral Nonlinearity**  
( $V_{CC} = 2.7V$ ,  $V_{REF} = 2.5V$ )



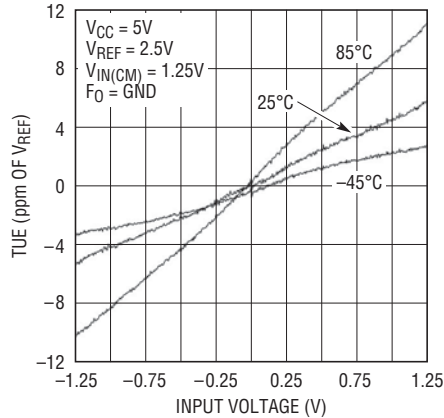
2492 G03

**Total Unadjusted Error**  
( $V_{CC} = 5V$ ,  $V_{REF} = 5V$ )



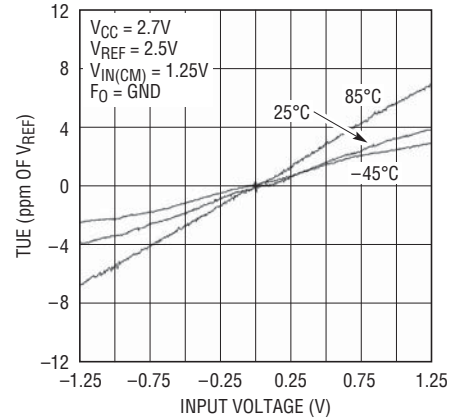
2492 G04

**Total Unadjusted Error**  
( $V_{CC} = 5V$ ,  $V_{REF} = 2.5V$ )



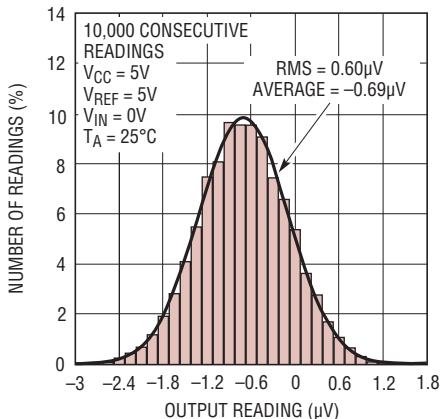
2492 G05

**Total Unadjusted Error**  
( $V_{CC} = 2.7V$ ,  $V_{REF} = 2.5V$ )



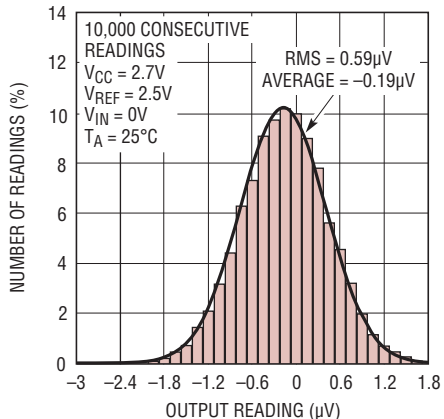
2492 G06

**Noise Histogram (6.8sps)**



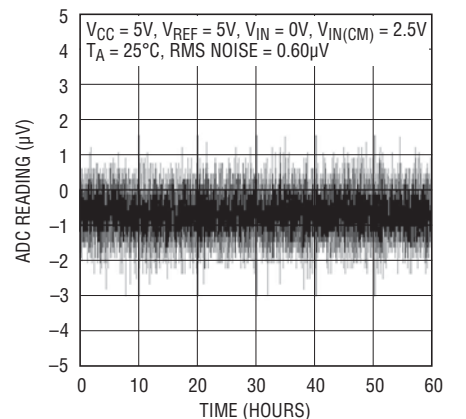
2492 G07

**Noise Histogram (7.5sps)**



2492 G08

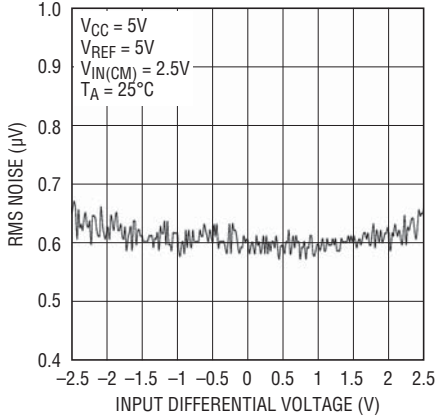
**Long-Term ADC Readings**



2492 G09

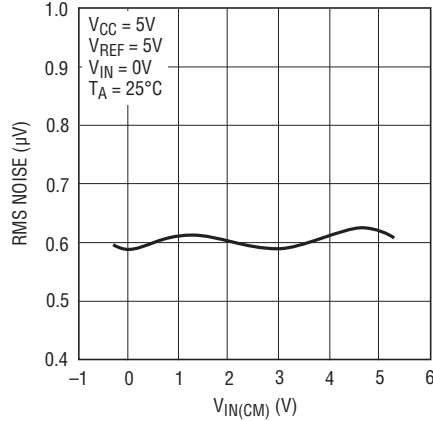
# TYPICAL PERFORMANCE CHARACTERISTICS

**RMS Noise vs Input Differential Voltage**



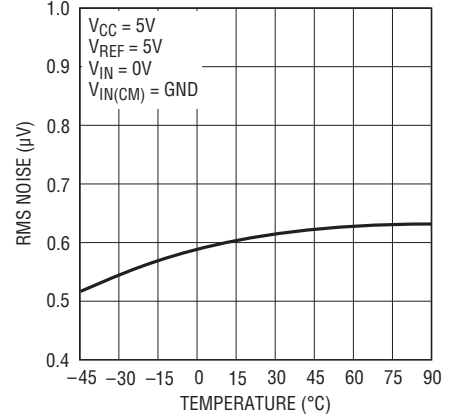
2492 G10

**RMS Noise vs  $V_{IN(CM)}$**



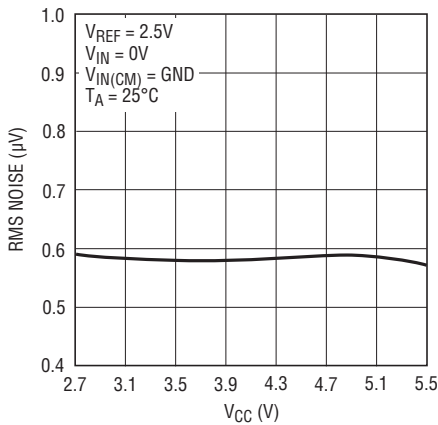
2492 G11

**RMS Noise vs Temperature ( $T_A$ )**



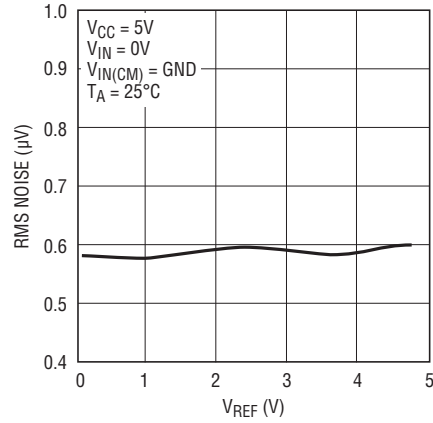
2492 G12

**RMS Noise vs  $V_{CC}$**



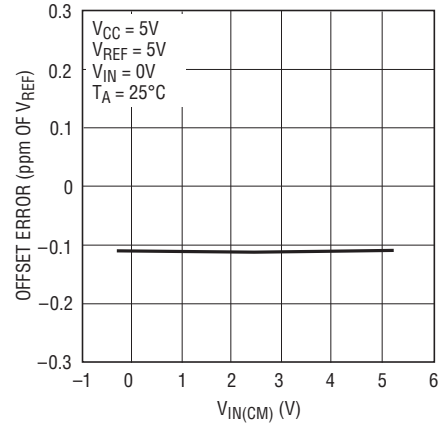
2492 G13

**RMS Noise vs  $V_{REF}$**



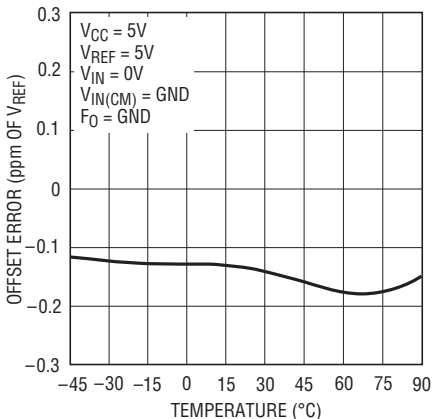
2492 G14

**Offset Error vs  $V_{IN(CM)}$**



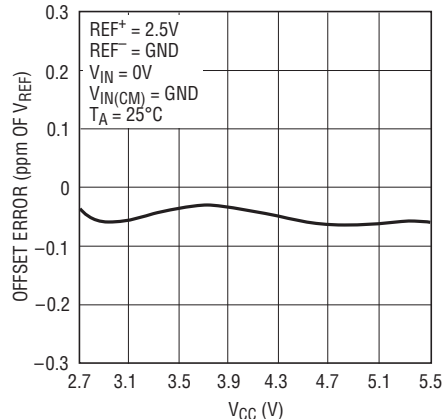
2492 G15

**Offset Error vs Temperature**



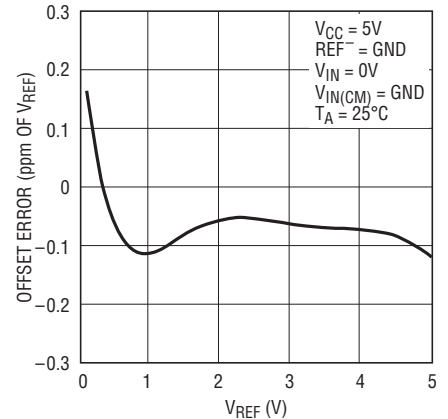
2492 G16

**Offset Error vs  $V_{CC}$**



2492 G17

**Offset Error vs  $V_{REF}$**

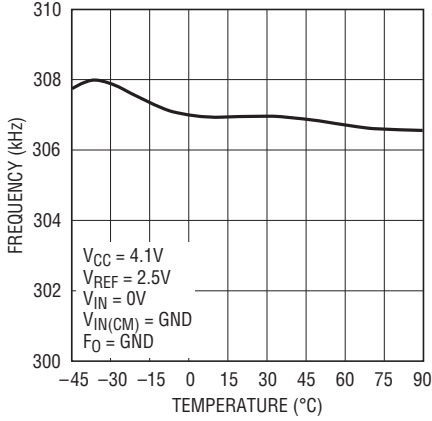


2492 G18



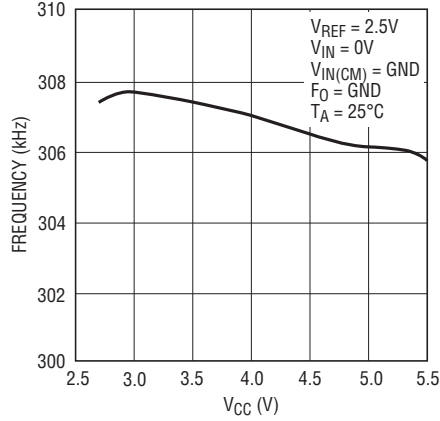
## TYPICAL PERFORMANCE CHARACTERISTICS

**On-Chip Oscillator Frequency vs Temperature**



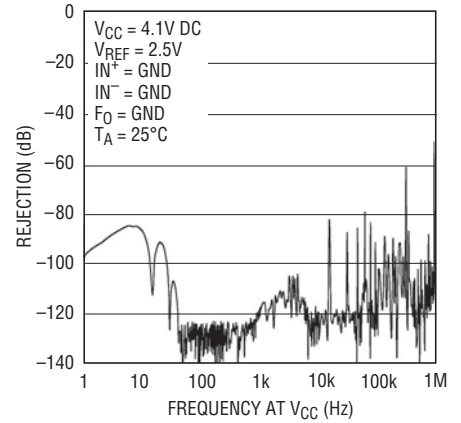
2492 G19

**On-Chip Oscillator Frequency vs  $V_{CC}$**



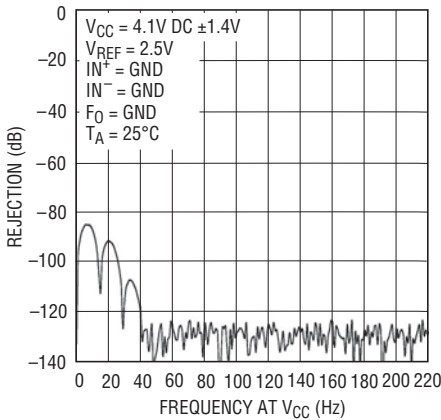
2492 G20

**PSRR vs Frequency at  $V_{CC}$**



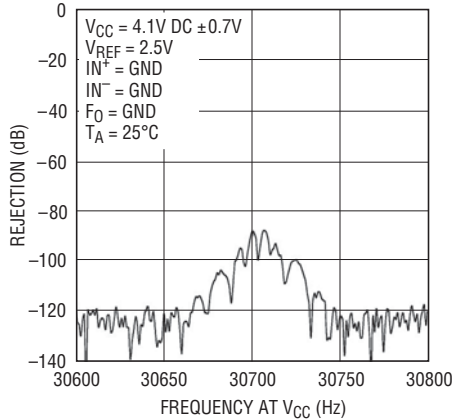
2492 G21

**PSRR vs Frequency at  $V_{CC}$**



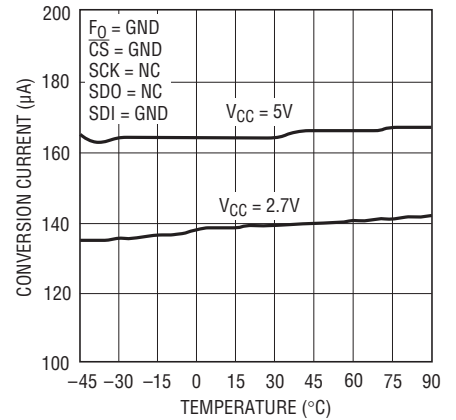
2492 G22

**PSRR vs Frequency at  $V_{CC}$**



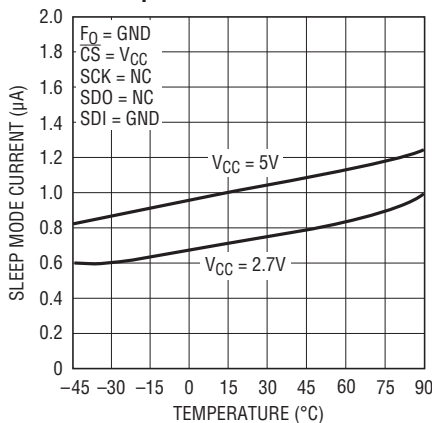
2492 G23

**Conversion Current vs Temperature**



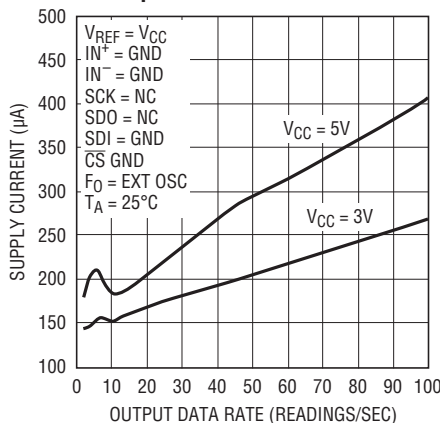
2492 G24

**Sleep Mode Current vs Temperature**



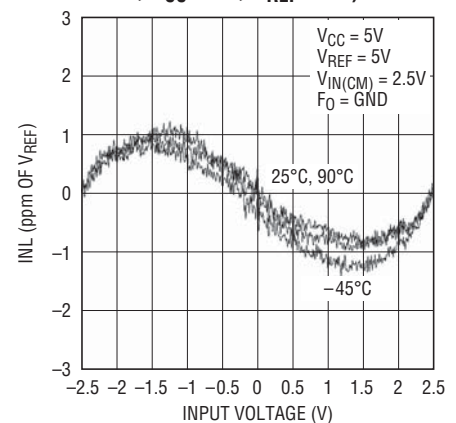
2492 G25

**Conversion Current vs Output Data Rate**



2492 G26

**Integral Nonlinearity (2x Speed Mode;  $V_{CC} = 5V$ ,  $V_{REF} = 5V$ )**

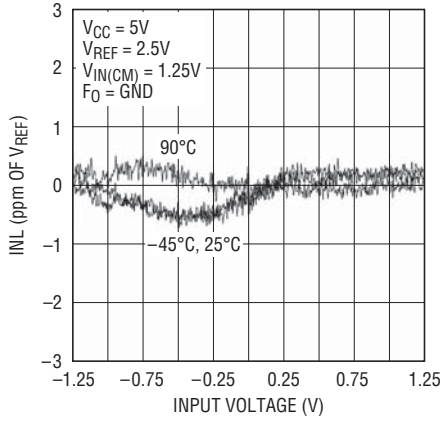


2492 G27



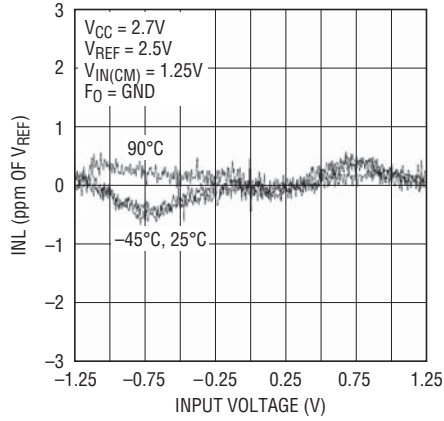
# TYPICAL PERFORMANCE CHARACTERISTICS

**Integral Nonlinearity (2x Speed Mode;  $V_{CC} = 5V$ ,  $V_{REF} = 2.5V$ )**



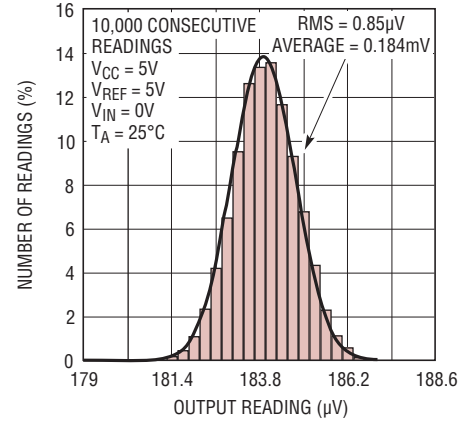
2492 G28

**Integral Nonlinearity (2x Speed Mode;  $V_{CC} = 2.7V$ ,  $V_{REF} = 2.5V$ )**



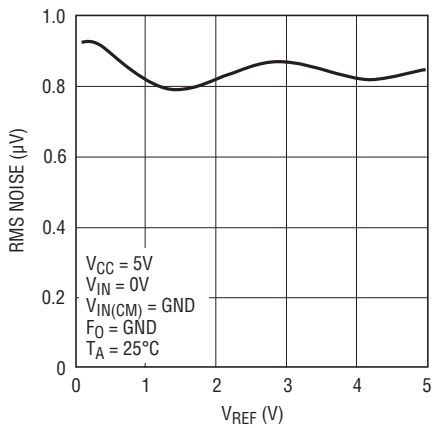
2492 G29

**Noise Histogram (2x Speed Mode)**



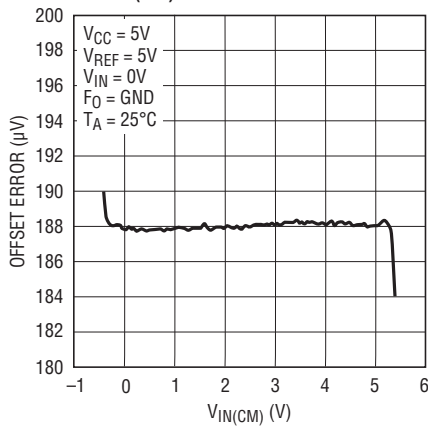
2492 G30

**RMS Noise vs  $V_{REF}$  (2x Speed Mode)**



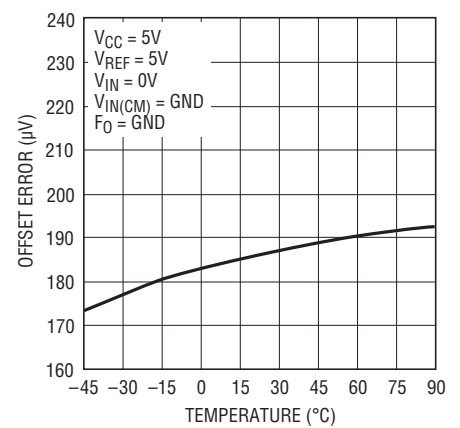
2492 G31

**Offset Error vs  $V_{IN(CM)}$  (2x Speed Mode)**



2492 G32

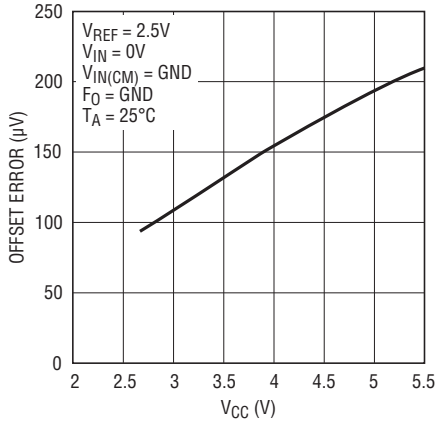
**Offset Error vs Temperature (2x Speed Mode)**



2492 G33

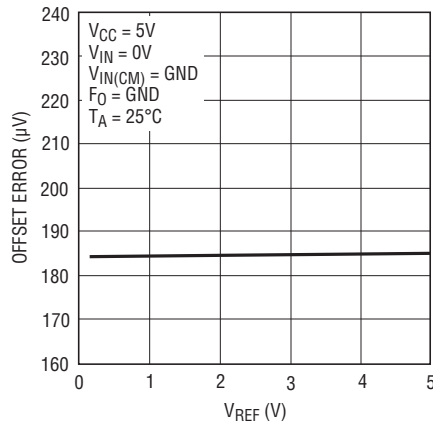
TYPICAL PERFORMANCE CHARACTERISTICS

Offset Error vs  $V_{CC}$  (2x Speed Mode)



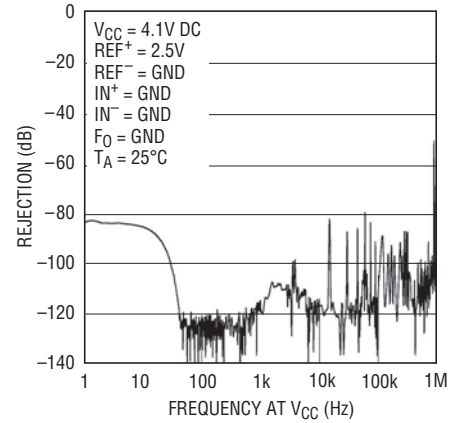
2492 G34

Offset Error vs  $V_{REF}$  (2x Speed Mode)



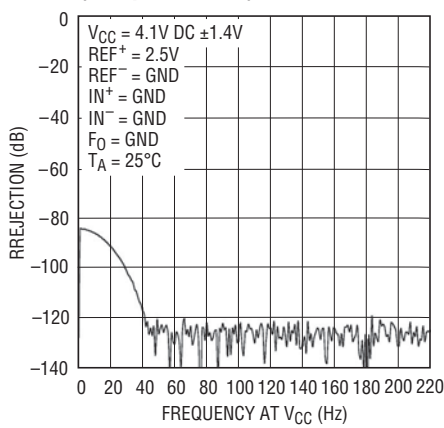
2492 G35

PSRR vs Frequency at  $V_{CC}$  (2x Speed Mode)



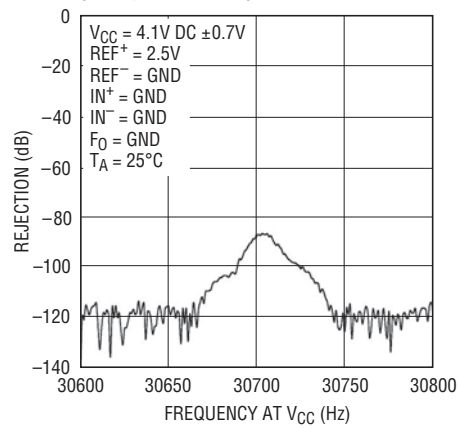
2492 G36

PSRR vs Frequency at  $V_{CC}$  (2x Speed Mode)



2492 G37

PSRR vs Frequency at  $V_{CC}$  (2x Speed Mode)



2492 G38

## PIN FUNCTIONS

**F<sub>0</sub> (Pin 1):** Frequency Control Pin. Digital input that controls the internal conversion clock rate. When F<sub>0</sub> is connected to GND, the converter uses its internal oscillator running at 307.2kHz. The conversion clock may also be overridden by driving the F<sub>0</sub> pin with an external clock in order to change the output rate and the digital filter rejection null.

**SDI (Pin 2):** Serial Data Input. This pin is used to select the line frequency rejection mode, 1× or 2× speed mode, temperature sensor, as well as the input channel. The serial data input is applied under control of the serial clock (SCK) during the data output/input operation. The first conversion following a new input or mode change is valid.

**SCK (Pin 3):** Bidirectional, Digital I/O, Clock Pin. In Internal Serial Clock Operation mode, SCK is generated internally and is seen as an output on the SCK pin. In External Serial Clock Operation mode, the digital I/O clock is externally applied to the SCK pin. The Serial Clock operation mode is determined by the logic level applied to the SCK pin at power up and during the most recent falling edge of  $\overline{CS}$ .

**$\overline{CS}$  (Pin 4):** Active LOW Chip Select. A LOW on this pin enables the digital input/output and wakes up the ADC. Following each conversion, the ADC automatically enters the Sleep mode and remains in this low power state as long as  $\overline{CS}$  is HIGH. A LOW-to-HIGH transition on  $\overline{CS}$  during the data output aborts the data transfer and starts a new conversion.

**SDO (Pin 5):** Three-State Digital Output. During the data output period, this pin is used as the serial data output. When the chip select pin is HIGH, the SDO pin is in a high impedance state. During the conversion and sleep periods,

this pin is used as the conversion status output. When the conversion is in progress this pin is HIGH; once the conversion is complete SDO goes low. The conversion status is monitored by pulling  $\overline{CS}$  LOW.

**GND (Pin 6):** Ground. Connect this pin to a common ground plane through a low impedance connection.

**COM (Pin 7):** The common negative input (IN<sup>-</sup>) for all single-ended multiplexer configurations. The voltage on CH0 to CH3 and COM pins can have any value between GND – 0.3V to V<sub>CC</sub> + 0.3V. Within these limits, the two selected inputs (IN<sup>+</sup> and IN<sup>-</sup>) provide a bipolar input range (V<sub>IN</sub> = IN<sup>+</sup> – IN<sup>-</sup>) from –0.5 • V<sub>REF</sub> to 0.5 • V<sub>REF</sub>. Outside this input range, the converter produces unique over-range and under-range output codes.

**CH0 to CH3 (Pins 8-11):** Analog Inputs. May be programmed for single-ended or differential mode.

**V<sub>CC</sub> (Pin 12):** Positive Supply Voltage. Bypass to GND with a 10μF tantalum capacitor in parallel with a 0.1μF ceramic capacitor as close to the part as possible.

**REF<sup>+</sup> (Pin 13), REF<sup>-</sup> (Pin 14):** Differential Reference Input. The voltage on these pins can have any value between GND and V<sub>CC</sub> as long as the reference positive input, REF<sup>+</sup>, remains more positive than the negative reference input, REF<sup>-</sup>, by at least 0.1V. The differential voltage (V<sub>REF</sub> = REF<sup>+</sup> – REF<sup>-</sup>) sets the fullscale range for all input channels. When performing an on-chip temperature measurement, the minimum value of REF = 2V.

**Exposed Pad (Pin 15):** Ground. This pin is ground and must be soldered to the PCB ground plane. For prototyping purposes, this pin may remain floating.

## FUNCTIONAL BLOCK DIAGRAM

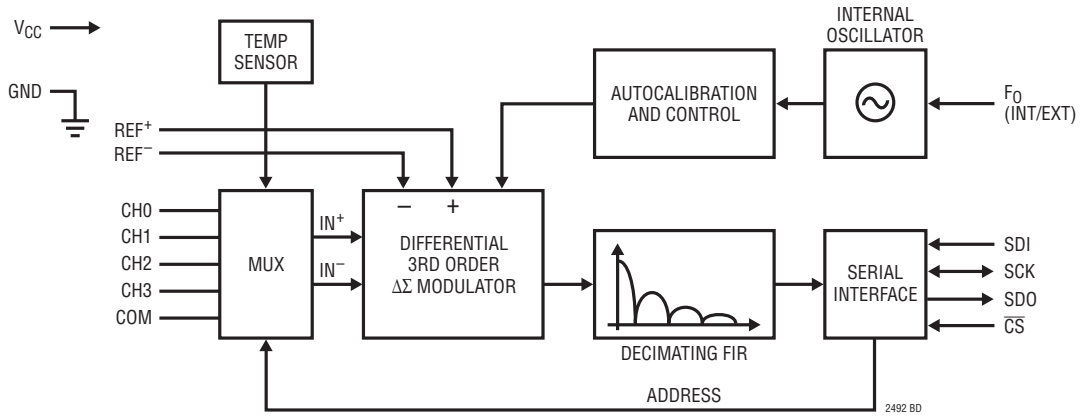


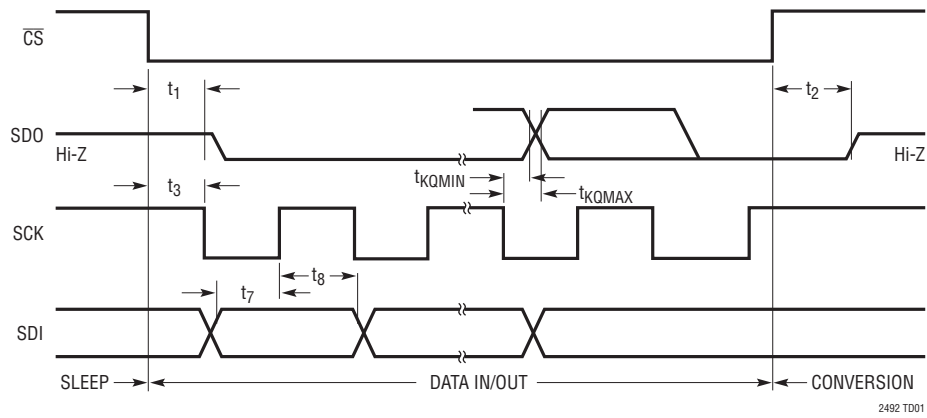
Figure 1. Functional Block Diagram

## TEST CIRCUITS

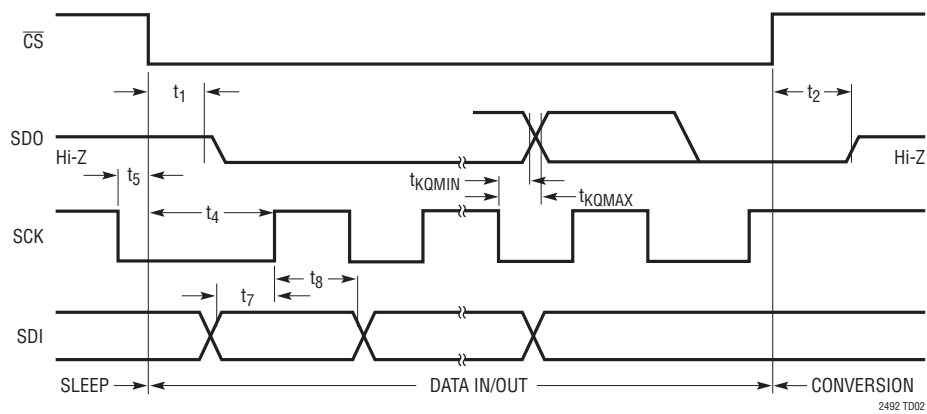


# TIMING DIAGRAMS

Timing Diagram Using Internal SCK (SCK HIGH with  $\overline{CS}\downarrow$ )



Timing Diagram Using External SCK (SCK LOW with  $\overline{CS}\downarrow$ )



## APPLICATIONS INFORMATION

### CONVERTER OPERATION

#### Converter Operation Cycle

The LTC2492 is a multi-channel, low power, delta-sigma analog-to-digital converter with an easy to use 4-wire interface and automatic differential input current cancellation. Its operation is made up of four states (See Figure 2). The converter operating cycle begins with the conversion, followed by the sleep state and ends with the data input/output cycle. The 4-wire interface consists of serial data output (SDO), serial clock (SCK), chip select ( $\overline{CS}$ ) and serial data input (SDI). The interface, timing, operation cycle, and data output format is compatible with Linear's entire family of SPI  $\Delta\Sigma$  converters.

Initially, at power up, the LTC2492 performs a conversion. Once the conversion is complete, the device enters the sleep state. While in this sleep state, if  $\overline{CS}$  is HIGH, power consumption is reduced by two orders of magnitude. The part remains in the sleep state as long as  $\overline{CS}$  is HIGH. The conversion result is held indefinitely in a static shift register while the part is in the sleep state.

Once  $\overline{CS}$  is pulled LOW, the device powers up, exits the sleep state, and enters the data input/output state. If  $\overline{CS}$  is brought HIGH before the first rising edge of SCK, the device returns to the sleep state and the power is reduced. If  $\overline{CS}$  is brought HIGH after the first rising edge of SCK, the

data output cycle is aborted and a new conversion cycle begins. The data output corresponds to the conversion just completed. This result is shifted out on the serial data output pin (SDO) under the control of the serial clock pin (SCK). Data is updated on the falling edge of SCK allowing the user to reliably latch data on the rising edge of SCK (See Figure 3). The configuration data for the next conversion is also loaded into the device at this time. Data is loaded from the serial data input pin (SDI) on each rising edge of SCK. The data input/output cycle concludes once 32 bits are read out of the ADC or when  $\overline{CS}$  is brought HIGH. The device automatically initiates a new conversion and the cycle repeats.

Through timing control of the  $\overline{CS}$  and SCK pins, the LTC2492 offers several flexible modes of operation (internal or external SCK and free-running conversion modes). These various modes do not require programming and do not disturb the cyclic operation described above. These modes of operation are described in detail in the Serial Interface Timing Modes section.

#### Ease of Use

The LTC2492 data output has no latency, filter settling delay, or redundant data associated with the conversion cycle. There is a one-to-one correspondence between the conversion and the output data. Therefore, multiplexing multiple analog inputs is straight forward. Each conversion, immediately following a newly selected input or mode, is valid and accurate to the full specifications of the device.

The LTC2492 automatically performs offset and full scale calibration every conversion cycle independent of the input channel selected. This calibration is transparent to the user and has no effect with the operation cycle described above. The advantage of continuous calibration is extreme stability of offset and full-scale readings with respect to time, supply voltage variation, input channel, and temperature drift.

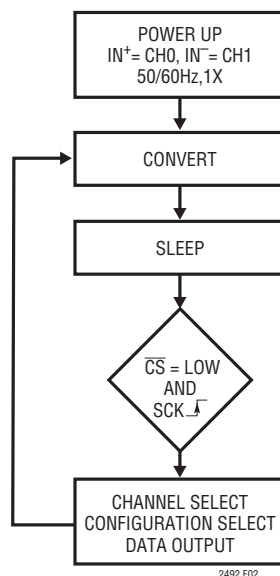


Figure 2. LTC2492 State Transition Diagram

## APPLICATIONS INFORMATION

### Easy Drive Input Current Cancellation

The LTC2492 combines a high precision delta-sigma ADC with an automatic, differential, input current cancellation front end. A proprietary front end passive sampling network transparently removes the differential input current. This enables external RC networks and high impedance sensors to directly interface to the LTC2492 without external amplifiers. The remaining common mode input current is eliminated by either balancing the differential input impedances or setting the common mode input equal to the common mode reference (see Automatic Differential Input Current Cancellation Section). This unique architecture does not require on-chip buffers, thereby enabling signals to swing beyond ground and  $V_{CC}$ . Moreover, the cancellation does not interfere with the transparent offset and full-scale auto-calibration and the absolute accuracy (full scale + offset + linearity + drift) is maintained even with external RC networks.

### Power-Up Sequence

The LTC2492 automatically enters an internal reset state when the power supply voltage  $V_{CC}$  drops below approximately 2V. This feature guarantees the integrity of the conversion result, input channel selection, and serial clock mode.

When  $V_{CC}$  rises above this threshold, the converter creates an internal power-on-reset (POR) signal with a duration of approximately 4ms. The POR signal clears all internal registers. The conversion immediately following a POR cycle is performed on the input channel  $IN^+ = CH0$ ,  $IN^- = CH1$ , simultaneous 50Hz/60Hz rejection and  $1\times$  output rate. The first conversion following a POR cycle is accurate within the specification of the device if the power supply voltage is restored to (2.7V to 5.5V) before the end of the POR interval. A new input channel, rejection mode, speed mode, or temperature selection can be programmed into the device during this first data input/output cycle.

### Reference Voltage Range

This converter accepts a truly differential external reference voltage. The absolute/common mode voltage range for  $REF^+$  and  $REF^-$  pins covers the entire operating range of the device (GND to  $V_{CC}$ ). For correct converter operation,  $V_{REF}$  must be positive ( $REF^+ > REF^-$ ).

The LTC2492 differential reference input range is 0.1V to  $V_{CC}$ . For the simplest operation,  $REF^+$  can be shorted to  $V_{CC}$  and  $REF^-$  can be shorted to GND. The converter output noise is determined by the thermal noise of the front end circuits, and as such, its value in nanovolts is nearly constant with reference voltage. A decrease in reference voltage will not significantly improve the converter's effective resolution. On the other hand, a decreased reference will improve the converter's overall INL performance.

### Input Voltage Range

The analog inputs are truly differential with an absolute, common mode range for the CH0 to CH3 and COM input pins extending from  $GND - 0.3V$  to  $V_{CC} + 0.3V$ . Outside these limits, the ESD protection devices begin to turn on and the errors due to input leakage current increase rapidly. Within these limits, the LTC2492 converts the bipolar differential input signal  $V_{IN} = IN^+ - IN^-$  (where  $IN^+$  and  $IN^-$  are the selected input channels), from  $-FS = -0.5 \cdot V_{REF}$  to  $+FS = 0.5 \cdot V_{REF}$  where  $V_{REF} = REF^+ - REF^-$ . Outside this range, the converter indicates the overrange or the underrange condition using distinct output codes (see Table 1).

Signals applied to the input (CH0 to CH3, COM) may extend 300mV below ground and above  $V_{CC}$ . In order to limit any fault current, resistors of up to 5k may be added in series with the input. The effect of series resistance on the converter accuracy can be evaluated from the curves presented in the Input Current/Reference Current sections. In addition, series resistors will introduce a temperature dependent error due to input leakage current. A 1nA input leakage current will develop a 1ppm offset error on a 5k resistor if  $V_{REF} = 5V$ . This error has a very strong temperature dependency.



## APPLICATIONS INFORMATION

### SERIAL INTERFACE PINS

The LTC2492 transmits the conversion result, reads the input configuration, and receives a start of conversion command through a synchronous 3- or 4-wire interface. During the conversion and sleep states, this interface can be used to access the converter status. During the data output state, it is used to read the conversion result, program the input channel, rejection frequency, speed multiplier, and select the temperature sensor.

#### Serial Clock Input/Output (SCK)

The serial clock pin (SCK) is used to synchronize the data input/output transfer. Each bit is shifted out of the SDO pin on the falling edge of SCK and data is shifted into the SDI pin on the rising edge of SCK.

The serial clock pin (SCK) can be configured as either a master (SCK is an output generated internally) or a slave (SCK is an input and applied externally). Master mode (Internal SCK) is selected by simply floating the SCK pin. Slave mode (External SCK) is selected by driving SCK low during power up and each falling edge of  $\overline{CS}$ . Specific details of these SCK modes are described in the Serial Interface Timing Modes section.

#### Serial Data Output (SDO)

The serial data output pin (SDO) provides the result of the last conversion as a serial bit stream (MSB first) during the data output state. In addition, the SDO pin is used as an end of conversion indicator during the conversion and sleep states.

When  $\overline{CS}$  is HIGH, the SDO driver is switched to a high impedance state in order to share the data output line with other devices. If  $\overline{CS}$  is brought LOW during the conversion phase, the  $\overline{EOC}$  bit (SDO pin) will be driven HIGH. Once the conversion is complete, if  $\overline{CS}$  is brought LOW,  $\overline{EOC}$  will be driven LOW indicating the conversion is complete and the result is ready to be shifted out of the device.

#### Chip Select ( $\overline{CS}$ )

The active low  $\overline{CS}$  pin is used to test the conversion status, enable I/O data transfer, initiate a new conversion, control

the duration of the sleep state, and set the SCK mode.

At the conclusion of a conversion cycle, while  $\overline{CS}$  is HIGH, the device remains in a low power sleep state where the supply current is reduced several orders of magnitude. In order to exit the sleep state and enter the data output state,  $\overline{CS}$  must be pulled low. Data is now shifted out the SDO pin under control of the SCK pin as described previously.

A new conversion cycle is initiated either at the conclusion of the data output cycle (all 32 data bits read) or by pulling  $\overline{CS}$  HIGH any time between the first and 32nd rising edges of the serial clock (SCK). In this case, the data output is aborted and a new conversion begins.

#### Serial Data Input (SDI)

The serial data input (SDI) is used to select the input channel, rejection frequency, speed multiplier and to access the integrated temperature sensor. Data is shifted into the device during the data output/input state on the rising edge of SCK while  $\overline{CS}$  is low.

### OUTPUT DATA FORMAT

The LTC2492 serial output stream is 32 bits long. The first bit indicates the conversion status, the second bit is always zero, and the third bit conveys sign information. The next 24 bits are the conversion result, MSB first. The remaining 5 bits are sub LSBs beyond the 24-bit level that may be included in averaging or discarded without loss of resolution.

Bit 31 (first output bit) is the end of conversion ( $\overline{EOC}$ ) indicator. This bit is available on the SDO pin during the conversion and sleep states whenever  $\overline{CS}$  is LOW. This bit is HIGH during the conversion cycle, goes LOW once the conversion is complete, and is HI-Z when  $\overline{CS}$  is HIGH.

Bit 30 (second output bit) is a dummy bit (DMY) and is always LOW.

Bit 29 (third output bit) is the conversion result sign indicator (SIG). If the selected input ( $V_{IN} = I_{N^+} - I_{N^-}$ ) is greater than 0V, this bit is HIGH. If  $V_{IN} < 0$ , this bit is LOW.

## APPLICATIONS INFORMATION

Bit 28 (fourth output bit) is the most significant bit (MSB) of the result. This bit in conjunction with Bit 29 also provides underrange and overrange indication. If both Bit 29 and Bit 28 are HIGH, the differential input voltage is above +FS. If both Bit 29 and Bit 28 are LOW, the differential input voltage is below -FS. The function of these bits is summarized in Table 1.

**Table 1. LTC2492 Status Bits**

Input Range	Bit 31 EOC	Bit 30 DMY	Bit 29 SIG	Bit 28 MSB
$V_{IN} \geq 0.5 \cdot V_{REF}$	0	0	1	1
$0V \leq V_{IN} < 0.5 \cdot V_{REF}$	0	0	1	0
$-0.5 \cdot V_{REF} \leq V_{IN} < 0V$	0	0	0	1
$V_{IN} < -0.5 \cdot V_{REF}$	0	0	0	0

Bits 28 to 5 are the 24-bit conversion result MSB first.

Bit 5 is the least significant bit (LSB<sub>24</sub>).

Bits 4 to 0 are sub LSBs below the 24-bit level. Bits 4 to 0 may be included in averaging or discarded without loss of resolution.

Data is shifted out of the SDO pin under control of the serial clock (SCK) (see Figure 3). Whenever CS is HIGH, SDO remains high impedance and SCK is ignored.

In order to shift the conversion result out of the device, CS must first be driven LOW. EOC is seen at the SDO pin of the device once CS is pulled LOW. EOC changes in real time as a function of the internal oscillator or the clock applied to the f<sub>0</sub> pin from HIGH to LOW at the completion of a conversion. This signal may be used as an interrupt for

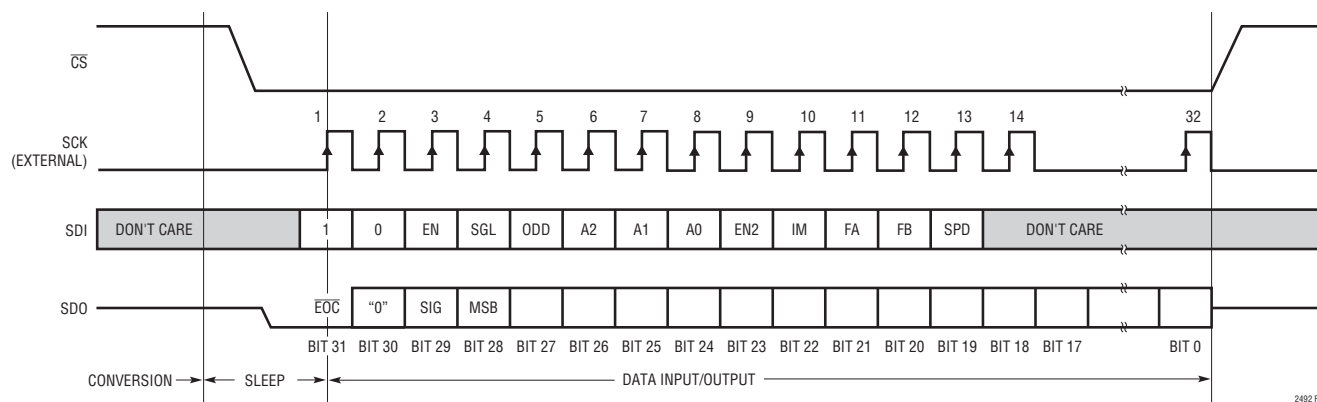
an external microcontroller. Bit 31 ( $\overline{EOC}$ ) can be captured on the first rising edge of SCK. Bit 30 is shifted out of the device on the first falling edge of SCK. The final data bit (Bit 0) is shifted out on the on the falling edge of the 31st SCK and may be latched on the rising edge of the 32nd SCK pulse. On the falling edge of the 32nd SCK pulse, SDO goes HIGH indicating the initiation of a new conversion cycle. This bit serves as  $\overline{EOC}$  (Bit 31) for the next conversion cycle. Table 2 summarizes the output data format.

As long as the voltage on the IN<sup>+</sup> and IN<sup>-</sup> pins remains between -0.3V and V<sub>CC</sub> + 0.3V (absolute maximum operating range) a conversion result is generated for any differential input voltage V<sub>IN</sub> from -FS = -0.5 • V<sub>REF</sub> to +FS = 0.5 • V<sub>REF</sub>. For differential input voltages greater than +FS, the conversion result is clamped to the value corresponding to +FS + 1LSB. For differential input voltages below -FS, the conversion result is clamped to the value -FS - 1LSB.

### INPUT DATA FORMAT

The LTC2492 serial input word is 13 bits long and contains two distinct sets of data. The first set (SGL, ODD, A2, A1, A0) is used to select the input channel. The second set of data (IM, FA, FB, SPD) is used to select the frequency rejection, speed mode (1×, 2×), and temperature measurement.

After power up, the device initiates an internal reset cycle which sets the input channel to CH0 to CH1 (IN<sup>+</sup> = CH0, IN<sup>-</sup> = CH1), the frequency rejection to simultaneous 50Hz/60Hz, and 1× output rate (auto-calibration enabled). The first



**Figure 3. Channel Selection, Configuration Selection and Data Output Timing**

## APPLICATIONS INFORMATION

Table 2. Output Data Format

Differential Input Voltage $V_{IN}^*$	Bit 31 `E`O`C	Bit 30 DMY	Bit 29 SIG	Bit 28 MSB	Bit 27	Bit 26	Bit 25	...	Bit 5 LSB	Bits 4 to 0 SUB LSBs
$V_{IN}^* \geq 0.5 \cdot V_{REF}^{**}$	0	0	1	1	0	0	0	...	0	00000
$0.5 \cdot V_{REF}^{**} - 1\text{LSB}$	0	0	1	0	1	1	1	...	1	XXXXX
$0.25 \cdot V_{REF}^{**}$	0	0	1	0	1	0	0	...	0	XXXXX
$0.25 \cdot V_{REF}^{**} - 1\text{LSB}$	0	0	1	0	0	1	1	...	1	XXXXX
0	0	0	1	0	0	0	0	...	0	XXXXX
-1LSB	0	0	0	1	1	1	1	...	1	XXXXX
$-0.25 \cdot V_{REF}^{**}$	0	0	0	1	1	0	0	...	0	XXXXX
$-0.25 \cdot V_{REF}^{**} - 1\text{LSB}$	0	0	0	1	0	1	1	...	1	XXXXX
$-0.5 \cdot V_{REF}^{**}$	0	0	0	1	0	0	0	...	0	XXXXX
$V_{IN}^* < -0.5 \cdot V_{REF}^{**}$	0	0	0	0	1	1	1	...	1	11111

\*The differential input voltage  $V_{IN} = IN^+ - IN^-$ . \*\*The differential reference voltage  $V_{REF} = REF^+ - REF^-$ .

\*\* Sub LSBs are below the 24-bit level. They may be included in averaging, or discarded without loss of resolution.

conversion automatically begins at power up using this default configuration. Once the conversion is complete, a new word may be written into the device.

The first three bits shifted into the device consist of two preamble bits and an enable bit. These bits are used to enable the device configuration and input channel selection. Valid settings for these three bits are 000, 100 and 101. Other combinations should be avoided. If the first three bits are 000 or 100, the following data is ignored (don't care) and the previously selected input channel and configuration remain valid for the next conversion.

If the first three bits shifted into the device are 101, then the next five bits select the input channel for the next conversion cycle (see Table 3).

Table 3 Channel Selection

MUX ADDRESS					CHANNEL SELECTION				
SGL	ODD/ SIGN	A2	A1	A0	0	1	2	3	COM
*0	0	0	0	0	IN <sup>+</sup>	IN <sup>-</sup>			
0	0	0	0	1			IN <sup>+</sup>	IN <sup>-</sup>	
0	1	0	0	0	IN <sup>-</sup>	IN <sup>+</sup>			
0	1	0	0	1			IN <sup>-</sup>	IN <sup>+</sup>	
1	0	0	0	0	IN <sup>+</sup>				IN <sup>-</sup>
1	0	0	0	1			IN <sup>+</sup>		IN <sup>-</sup>
1	1	0	0	0		IN <sup>+</sup>			IN <sup>-</sup>
1	1	0	0	1				IN <sup>+</sup>	IN <sup>-</sup>

\*Default at power up

The first input bit (SGL) following the 101 sequence determines if the input selection is differential (SGL = 0) or single-ended (SGL = 1). For SGL = 0, two adjacent channels can be selected to form a differential input. For SGL = 1, one of four channels is selected as the positive input. The negative input is COM for all single-ended operations. The remaining four bits (ODD, A2, A1, A0) determine which channel(s) is/are selected and the polarity (for a differential input).

The next serial input bit immediately following the input channel selection is the enable bit for the conversion configuration (EN2). If this bit is set to 0, then the next conversion is performed using the previously selected converter configuration.

A new configuration can be loaded into the device by setting EN2 = 1 (see Table 4). The first bit (IM) is used to select the internal temperature sensor. If IM = 1, the following conversion will be performed on the internal temperature sensor rather than the selected input channel. The next two bits (FA and FB) are used to set the rejection frequency. The final bit (SPD) is used to select either the 1x output rate if SPD = 0 (auto-calibration is enabled and the offset is continuously calibrated and removed from the final conversion result) or the 2x output rate if SPD = 1 (offset calibration disabled, multiplexing output rates up to 15Hz with no latency). When IM = 1 (temperature measurement) SPD will be ignored and the device will operate in 1x mode. The configuration remains valid until

## APPLICATIONS INFORMATION

Table 4. Converter Configuration

1	0	EN	SGL	ODD	A2	A1	A0	EN2	IM	FA	FB	SPD	CONVERTER CONFIGURATION
1	0	0	X	X	X	X	X	X	X	X	X	X	Keep Previous
1	0	1	X	X	X	X	X	0	X	X	X	X	Keep Previous
0	0	0	X	X	X	X	X	X	X	X	X	X	Keep Previous
1	0	1	X	X	X	X	X	1	0	0	0	0	External Input (See Table 3) 50Hz/60Hz Rejection, 1x
1	0	1	X	X	X	X	X	1	0	0	1	0	External Input (See Table 3) 50Hz Rejection, 1x
1	0	1	X	X	X	X	X	1	0	1	0	0	External Input (See Table 3) 60Hz Rejection, 1x
1	0	1	X	X	X	X	X	1	0	0	0	1	External Input (See Table 3) 50Hz/60Hz Rejection, 2x
1	0	1	X	X	X	X	X	1	0	0	1	1	External Input (See Table 3) 50Hz Rejection, 2x
1	0	1	X	X	X	X	X	1	0	1	0	1	External Input (See Table 3) 60Hz Rejection, 2x
1	0	1	X	X	X	X	X	1	1	0	0	X	Measure Temperature 50Hz/60Hz Rejection, 1x
1	0	1	X	X	X	X	X	1	1	0	1	X	Measure Temperature 50Hz Rejection, 1x
1	0	1	X	X	X	X	X	1	1	1	0	X	Measure Temperature 60Hz Rejection, 1x
1	0	1	X	X	X	X	X	1	X	1	1	X	Reserved, Do Not Use

a new input word with EN = 1 (the first three bits are 101) and EN2 = 1 is shifted into the device.

### Rejection Mode (FA, FB)

The LTC2492 includes a high accuracy on-chip oscillator with no required external components. Coupled with an integrated 4th order digital low pass filter, the LTC2492 rejects line frequency noise. In the default mode, the LTC2492 simultaneously rejects 50Hz and 60Hz by at least 87dB. If more rejection is required, the LTC2492 can be configured to reject 50Hz or 60Hz to better than 110dB.

### Speed Mode (SPD)

Every conversion cycle, two conversions are combined to remove the offset (default mode). This result is free from offset and drift. In applications where the offset is not critical, the auto-calibration feature can be disabled with the benefit of twice the output rate. While operating in the 2x mode (SPD = 1), the linearity and full-scale errors are unchanged from the 1x mode performance. In both the

1x and 2x mode there is no latency. This enables input steps or multiplexer changes to settle in a single conversion cycle, easing system overhead and increasing the effective conversion rate. During temperature measurements, the 1x mode is always used independent of the value of SPD.

### Temperature Sensor

The LTC2492 includes an integrated temperature sensor. The temperature sensor is selected by setting IM = 1. The digital output is proportional to the absolute temperature of the device. This feature allows the converter to perform cold junction compensation for external thermocouples or continuously remove the temperature effects of external sensors.

The internal temperature sensor output is 28mV at 27°C (300°K), with a slope of 93.5 $\mu$ V/°C independent of V<sub>REF</sub> (see Figures 4 and 5). Slope calibration is not required if the reference voltage (V<sub>REF</sub>) is known. A 5V reference has a slope of 314 LSBs<sub>24</sub>/°C. The temperature is calculated

## APPLICATIONS INFORMATION

from the output code (DATAOUT<sub>24</sub>) for a 5V reference using the following formula:

$$T_K = \text{DATAOUT}_{24} / 314 \text{ in Kelvin}$$

If a different value of V<sub>REF</sub> is used, the temperature output is:

$$T_K = \text{DATAOUT}_{24} \cdot V_{\text{REF}} / 1570 \text{ in Kelvin}$$

If the value of V<sub>REF</sub> is not known, the slope is determined by measuring the temperature sensor at a known temperature T<sub>N</sub> (in °K) and using the following formula:

$$\text{SLOPE} = \text{DATAOUT}_{24} / T_N$$

This value of slope can be used to calculate further temperature readings using:

$$T_K = \text{DATAOUT}_{24} / \text{SLOPE}$$

All Kelvin temperature readings can be converted to T<sub>C</sub> (°C) using the fundamental equation:

$$T_C = T_K - 273$$

## SERIAL INTERFACE TIMING MODES

The LTC2492's 4-wire interface is SPI and MICROWIRE compatible. This interface offers several flexible modes of operation. These include internal/external serial clock, 3- or 4-wire I/O, single cycle or continuous conversion. The following sections describe each of these timing modes in detail. In all cases, the converter can use the internal oscillator (F<sub>0</sub> = LOW) or an external oscillator connected to the F<sub>0</sub> pin. For each mode, the operating cycle, data input format, data output format, and performance remain the same. Refer to Table 5 for a summary.

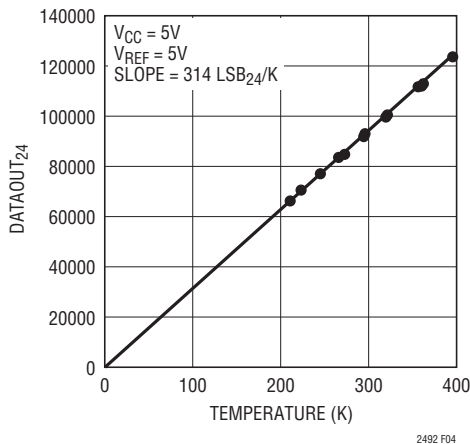


Figure 4. Internal PTAT Digital Output vs Temperature

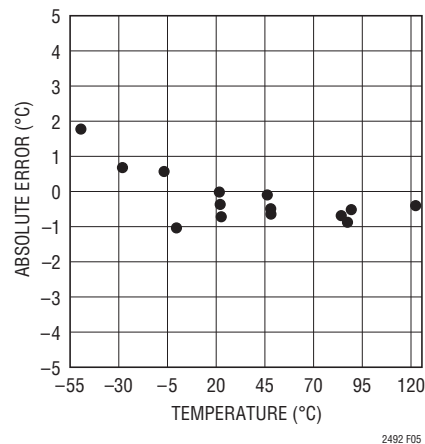


Figure 5. Absolute Temperature Error

Table 5. Serial Interface Timing Modes

CONFIGURATION	SCK SOURCE	CONVERSION CYCLE CONTROL	DATA OUTPUT CONTROL	CONNECTION AND WAVEFORMS
External SCK, Single Cycle Conversion	External	$\overline{\text{CS}}$ and SCK	$\overline{\text{CS}}$ and SCK	Figures 6, 7
External SCK, 3-Wire I/O	External	SCK	SCK	Figure 8
Internal SCK, Single Cycle Conversion	Internal	$\overline{\text{CS}}\downarrow$	$\overline{\text{CS}}\downarrow$	Figures 9, 10
Internal SCK, 3-Wire I/O, Continuous Conversion	Internal	Continuous	Internal	Figure 11

## APPLICATIONS INFORMATION

### External Serial Clock, Single Cycle Operation

This timing mode uses an external serial clock to shift out the conversion result and  $\overline{CS}$  to monitor and control the state of the conversion cycle (see Figure 6).

The external serial clock mode is selected during the power-up sequence and on each falling edge of  $\overline{CS}$ . In order to enter and remain in the external SCK mode of operation, SCK must be driven LOW both at power up and on each  $\overline{CS}$  falling edge. If SCK is HIGH on the falling edge of  $\overline{CS}$ , the device will switch to the internal SCK mode.

The serial data output pin (SDO) is Hi-Z as long as  $\overline{CS}$  is HIGH. At any time during the conversion cycle,  $\overline{CS}$  may be pulled LOW in order to monitor the state of the converter. While  $\overline{CS}$  is LOW,  $\overline{EOC}$  is output to the SDO pin.

$\overline{EOC} = 1$  while a conversion is in progress and  $\overline{EOC} = 0$  if the conversion is complete and the device is in the sleep state. Independent of  $\overline{CS}$ , the device automatically enters the sleep state once the conversion is complete; however, in order to reduce the power,  $\overline{CS}$  must be HIGH.

When the device is in the sleep state, its conversion result is held in an internal static shift register. The device remains in the sleep state until the first rising edge of SCK is seen while  $\overline{CS}$  is LOW. The input data is then shifted in via the SDI pin on each rising edge of SCK (including the first rising edge). The channel selection and converter configuration mode will be used for the following conversion cycle. If the input channel or converter configuration is changed during this I/O cycle, the new settings take effect on the conversion cycle following the data input/output cycle. The output data is shifted out the SDO pin on each falling edge of SCK. This enables external circuitry to latch the output on the rising edge of SCK.  $\overline{EOC}$  can be latched on the first rising edge of SCK and the last bit of the conversion result can be latched on the 32nd rising edge of SCK. On the 32nd falling edge of SCK, the device begins a new conversion and SDO goes HIGH ( $\overline{EOC} = 1$ ) indicating a conversion is in progress.

At the conclusion of the data cycle,  $\overline{CS}$  may remain LOW and  $\overline{EOC}$  monitored as an end-of-conversion interrupt.

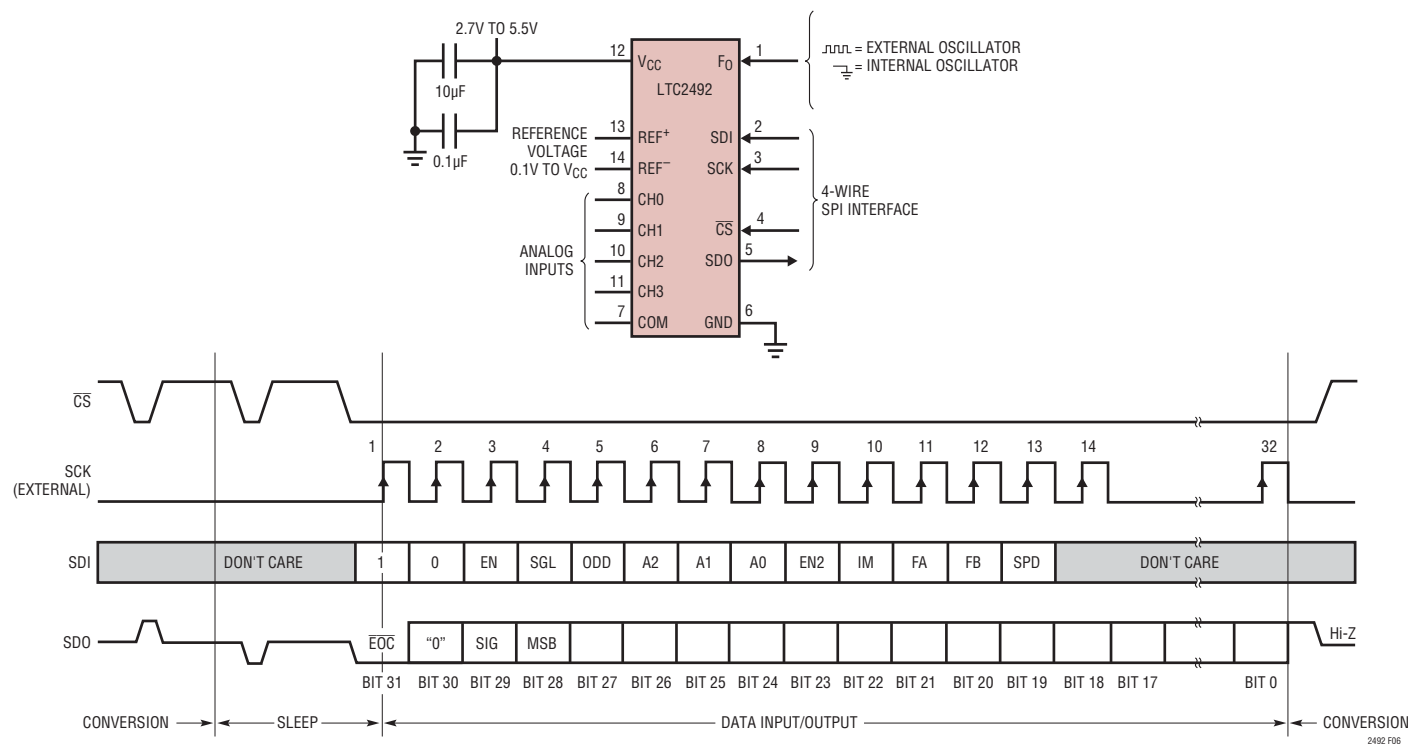


Figure 6. External Serial Clock, Single Cycle Operation



## APPLICATIONS INFORMATION

Typically,  $\overline{CS}$  remains LOW during the data output/input state. However, the data output state may be aborted by pulling  $\overline{CS}$  HIGH any time between the 1st falling edge and the 32nd falling edge of SCK (see Figure 7). On the rising edge of  $\overline{CS}$ , the device aborts the data output state and immediately initiates a new conversion. In order to program a new input channel, 8 SCK clock pulses are required. If the data output sequence is aborted prior to the 8th falling edge of SCK, the new input data is ignored and the previously selected input channel remains valid. If the rising edge of  $\overline{CS}$  occurs after the 8th falling edge of SCK, the new input channel is loaded and valid for the next conversion cycle. If  $\overline{CS}$  goes high between the 8th falling edge and the 16th falling edge of SCK, the new channel is still loaded, but the converter configuration remains unchanged. In order to program both the input channel and converter configuration,  $\overline{CS}$  must go high after the 16th falling edge of SCK (at this point all data has been shifted into the device).

### External Serial Clock, 3-Wire I/O

This timing mode uses a 3-wire serial I/O interface. The conversion result is shifted out of the device by an externally generated serial clock (SCK) signal (see Figure 8).  $\overline{CS}$  is permanently tied to ground, simplifying the user interface or isolation barrier.

The external serial clock mode is selected at the end of the power-on reset (POR) cycle. The POR cycle typically concludes 4ms after  $V_{CC}$  exceeds 2V. The level applied to SCK at this time determines if SCK is internally generated or externally applied. In order to enter the external SCK mode, SCK must be driven LOW prior to the end of the POR cycle.

Since  $\overline{CS}$  is tied LOW, the end-of-conversion ( $\overline{EOC}$ ) can be continuously monitored at the SDO pin during the convert and sleep states.  $\overline{EOC}$  may be used as an interrupt to an external controller.  $\overline{EOC} = 1$  while the conversion is in progress and  $\overline{EOC} = 0$  once the conversion is complete.

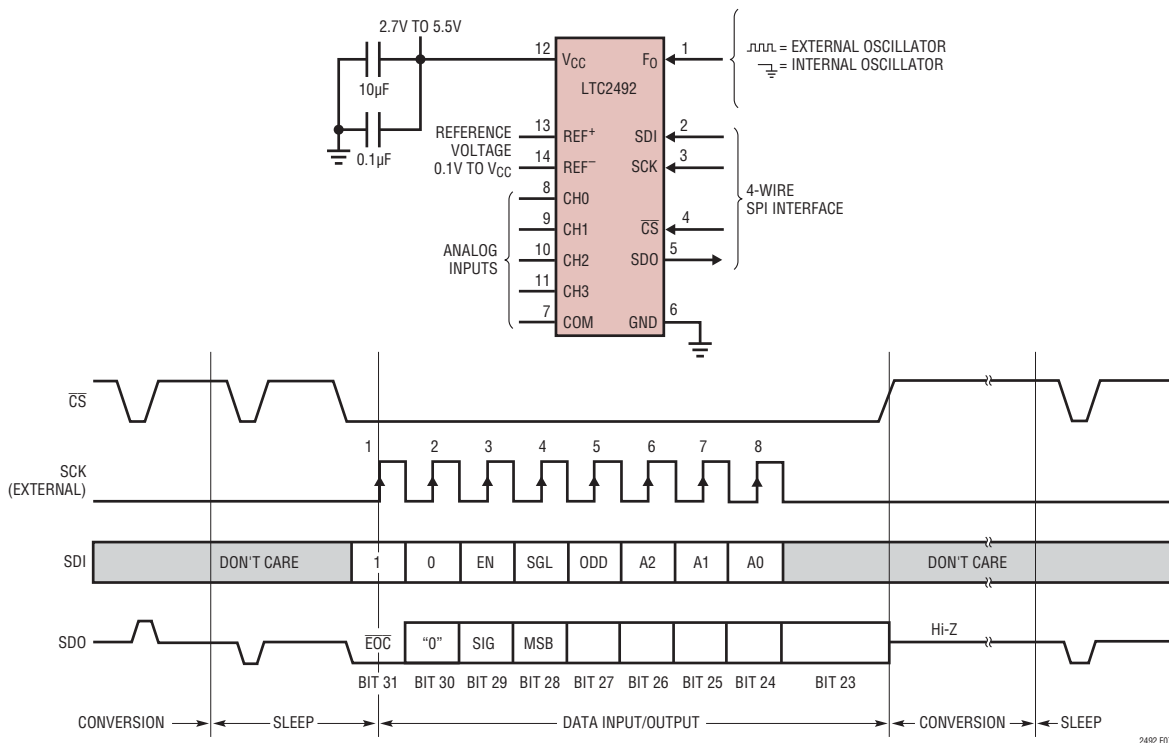


Figure 7. External Serial Clock, Reduced Output Data Length and Valid Channel Selection



## APPLICATIONS INFORMATION

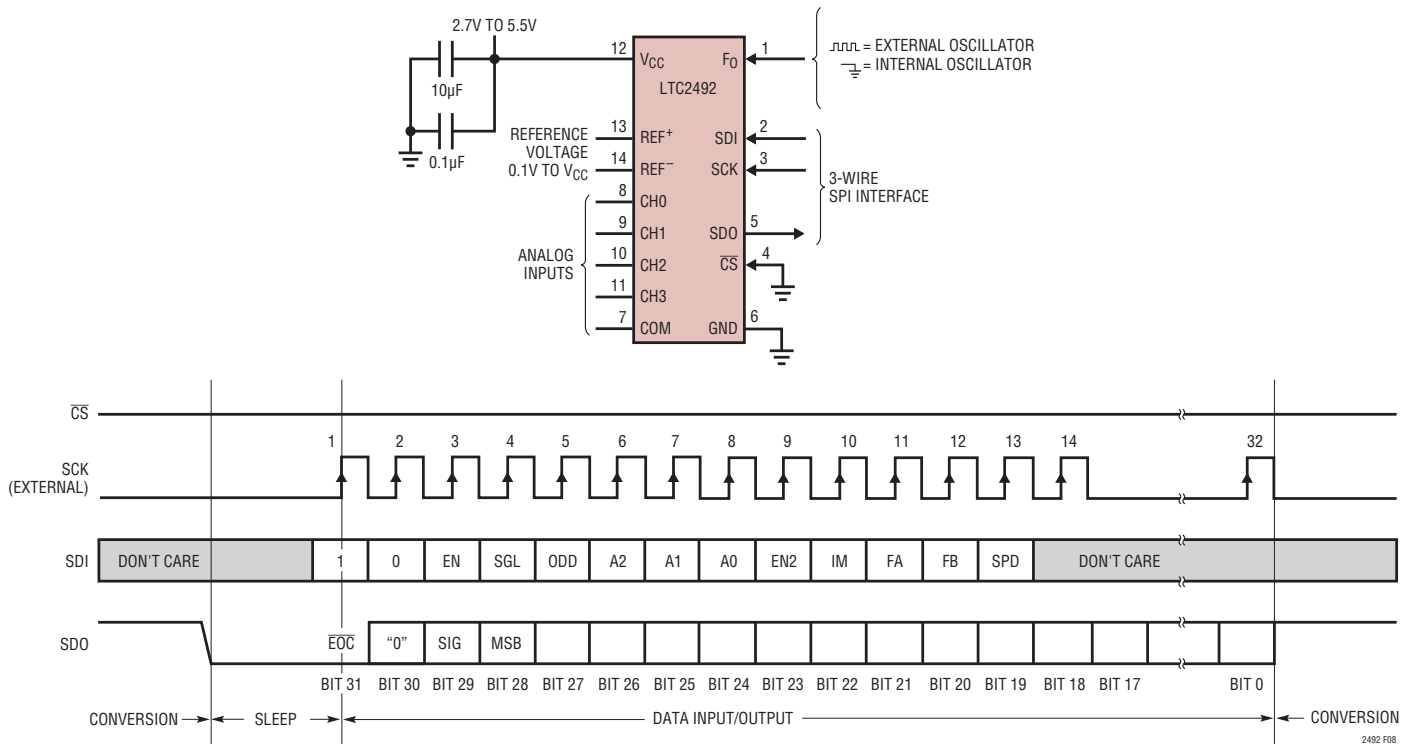


Figure 8. External Serial Clock, 3-Wire Operation ( $\overline{CS} = 0$ )

On the falling edge of  $\overline{EOC}$ , the conversion result is loading into an internal static shift register. The output data can now be shifted out the SDO pin under control of the externally applied SCK signal. Data is updated on the falling edge of SCK. The input data is shifted into the device through the SDI pin on the rising edge of SCK. On the 32nd falling edge of SCK, SDO goes HIGH, indicating a new conversion has begun. This data now serves as  $\overline{EOC}$  for the next conversion.

### Internal Serial Clock, Single Cycle Operation

This timing mode uses the internal serial clock to shift out the conversion result and  $\overline{CS}$  to monitor and control the state of the conversion cycle (see Figure 9).

In order to select the internal serial clock timing mode, the serial clock pin (SCK) must be floating or pulled HIGH before the conclusion of the POR cycle and prior to each falling edge of  $\overline{CS}$ . An internal weak pull-up resistor is active on the SCK pin during the falling edge of  $\overline{CS}$ ; therefore, the internal SCK mode is automatically selected if SCK is not externally driven.

The serial data output pin (SDO) is Hi-Z as long as  $\overline{CS}$  is HIGH. At any time during the conversion cycle,  $\overline{CS}$  may be pulled low in order to monitor the state of the converter. Once  $\overline{CS}$  is pulled LOW, SCK goes LOW and  $\overline{EOC}$  is output to the SDO pin.  $\overline{EOC} = 1$  while the conversion is in progress and  $\overline{EOC} = 0$  if the device is in the sleep state.

When testing  $\overline{EOC}$ , if the conversion is complete ( $\overline{EOC} = 0$ ), the device will exit sleep state. In order to return to the sleep state and reduce the power consumption,  $\overline{CS}$  must be pulled HIGH before the device pulls SCK HIGH. When the device is using its own internal oscillator ( $F_0$  is tied LOW), the first rising edge of SCK occurs  $12\mu\text{s}$  ( $t_{EOCTEST} = 12\mu\text{s}$ ) after the falling edge of  $\overline{CS}$ . If  $F_0$  is driven by an external oscillator of frequency  $f_{EOC}$ , then  $t_{EOCTEST} = 3.6/f_{EOC}$ .

If  $\overline{CS}$  remains LOW longer than  $t_{EOCTEST}$ , the first rising edge of SCK will occur and the conversion result is shifted out the SDO pin on the falling edge of SCK. The serial input word (SDI) is shifted into the device on the rising edge of SCK.

After the 32nd rising edge of SCK a new conversion automatically begins. SDO goes HIGH ( $\overline{EOC} = 1$ ) and SCK

## APPLICATIONS INFORMATION

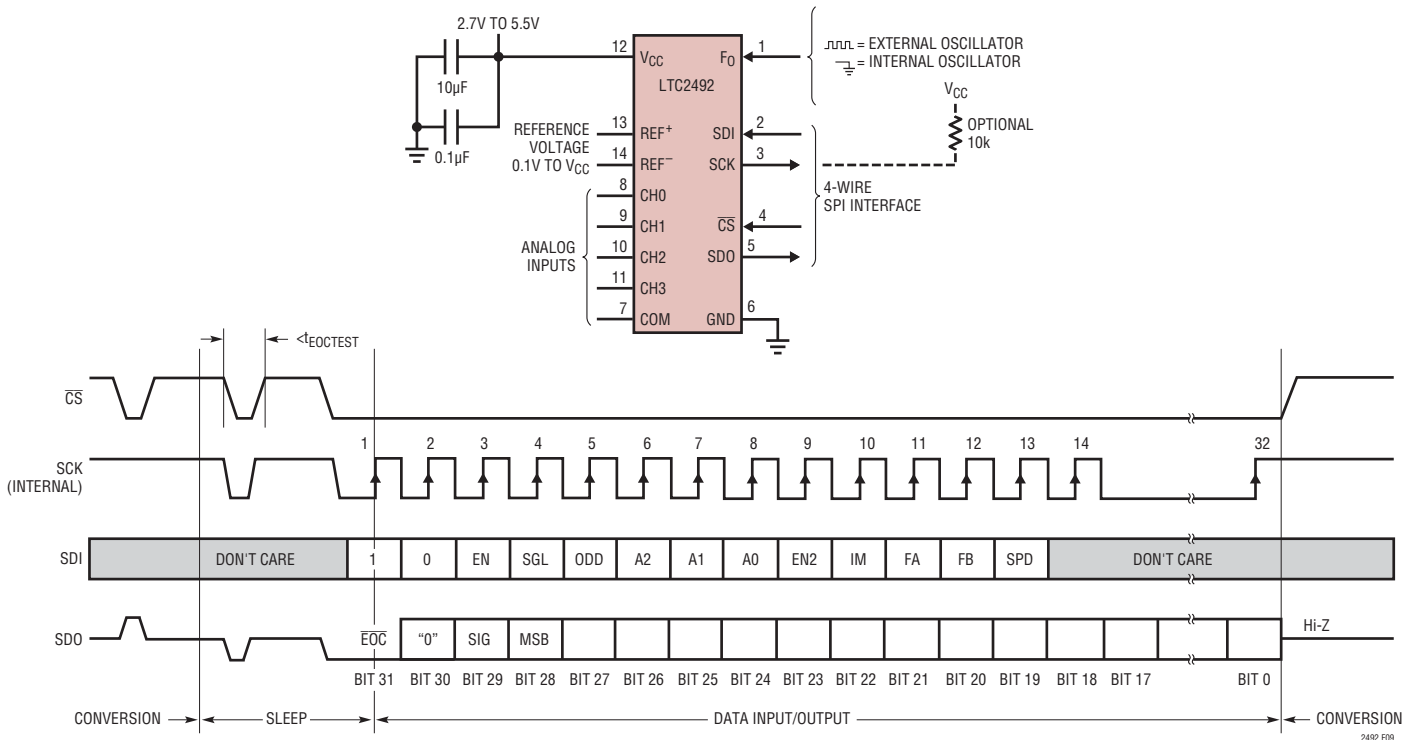


Figure 9. Internal Serial Clock, Single Cycle Operation

remains HIGH for the duration of the conversion cycle. Once the conversion is complete, the cycle repeats.

Typically,  $\overline{CS}$  remains LOW during the data output state. However, the data output state may be aborted by pulling  $\overline{CS}$  HIGH any time between the 1st rising edge and the 32nd falling edge of SCK (see Figure 10). On the rising edge of  $\overline{CS}$ , the device aborts the data output state and immediately initiates a new conversion. In order to program a new input channel, 8 SCK clock pulses are required. If the data output sequence is aborted prior to the 8th falling edge of SCK, the new input data is ignored and the previously selected input channel remains valid. If the rising edge of  $\overline{CS}$  occurs after the 8th falling edge of SCK, the new input channel is loaded and valid for the next conversion cycle. If  $\overline{CS}$  goes high between the 8th falling edge and the 16th falling edge of SCK, the new channel is still loaded, but the converter configuration remains unchanged. In order to program both the input channel and converter configuration,  $\overline{CS}$  must go high after the 16th falling edge of SCK (at this point all data has been shifted into the device).

### Internal Serial Clock, 3-Wire I/O, Continuous Conversion.

This timing mode uses a 3-wire interface. The conversion result is shifted out of the device by an internally generated serial clock (SCK) signal (see Figure 11). In this case,  $\overline{CS}$  is permanently tied to ground, simplifying the user interface or transmission over an isolation barrier.

The internal serial clock mode is selected at the end of the power-on reset (POR) cycle. The POR cycle is concluded approximately 4ms after  $V_{CC}$  exceeds 2V. An internal weak pull-up is active during the POR cycle; therefore, the internal serial clock timing mode is automatically selected if SCK is floating or driven HIGH.

During the conversion, the SCK and the serial data output pin (SDO) are HIGH ( $\overline{EOC} = 1$ ). Once the conversion is complete, SCK and SDO go LOW ( $\overline{EOC} = 0$ ) indicating the conversion has finished and the device has entered the sleep state. The device remains in the sleep state a minimum amount of time (1/2 the internal SCK period) then immediately begins outputting and inputting data.

# APPLICATIONS INFORMATION

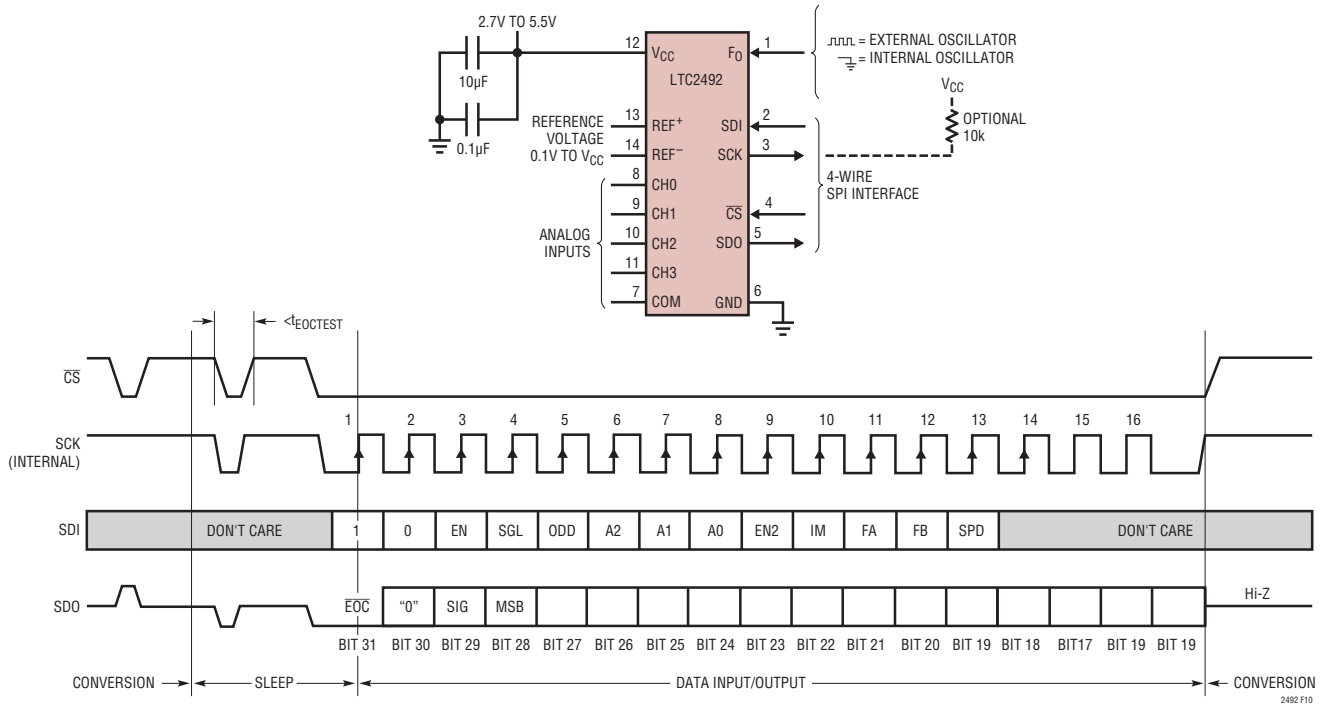


Figure 10. Internal Serial Clock, Reduced Data Output Length with Valid Channel and Configuration Selection

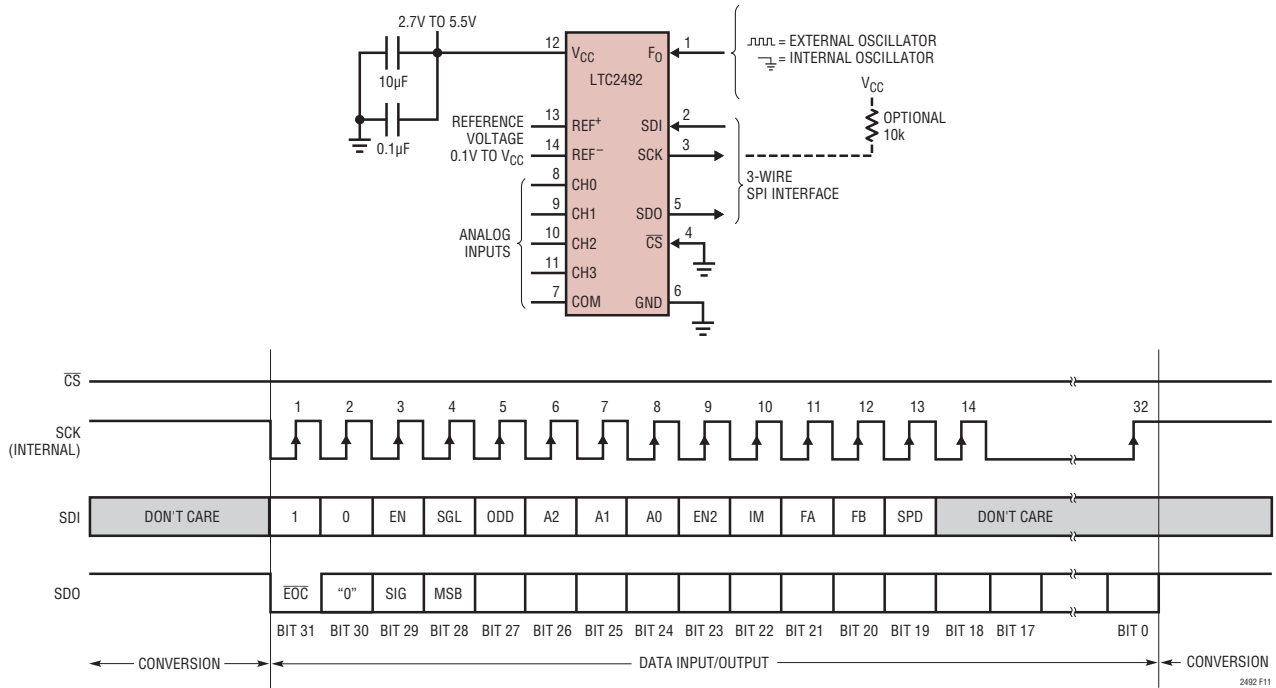


Figure 11. Internal Serial Clock, Continuous Operation

## APPLICATIONS INFORMATION

The input data is shifted through the SDI pin on the rising edge of SCK (including the first rising edge) and the output data is shifted out the SDO pin on the falling edge of SCK. The data input/output cycle is concluded and a new conversion automatically begins after the 32nd rising edge of SCK. During the next conversion, SCK and SDO remain HIGH until the conversion is complete.

### The Use of a 10k Pull-Up on SCK for Internal SCK Selection

If  $\overline{\text{CS}}$  is pulled HIGH while the converter is driving SCK LOW, the internal pull-up is not available to restore SCK to a logic HIGH state if SCK is floating. This will cause the device to exit the internal SCK mode on the next falling edge of  $\overline{\text{CS}}$ . This can be avoided by adding an external 10k pull-up resistor to the SCK pin.

Whenever SCK is LOW, the LTC2492's internal pull-up at SCK is disabled. Normally, SCK is not externally driven if the device is operating in the internal SCK timing mode. However, certain applications may require an external driver on SCK. If the driver goes Hi-Z after outputting a LOW signal, the internal pull-up is disabled. An external 10k pull-up resistor prevents the device from exiting the internal SCK mode under this condition.

A similar situation may occur during the sleep state when  $\overline{\text{CS}}$  is pulsed HIGH-LOW-HIGH in order to test the conversion status. If the device is in the sleep state ( $\overline{\text{EOC}} = 0$ ), SCK will go LOW. If  $\overline{\text{CS}}$  goes HIGH before the time  $t_{\text{EOCtest}}$ , the internal pull-up is activated. If SCK is heavily loaded, the internal pull-up may not restore SCK to a HIGH state before the next falling edge of  $\overline{\text{CS}}$ . The external 10k pull-up resistor prevents the device from exiting the internal SCK mode under this condition.

### PRESERVING THE CONVERTER ACCURACY

The LTC2492 is designed to reduce as much as possible sensitivity to device decoupling, PCB layout, anti-aliasing circuits, line frequency perturbations, and temperature sensitivity. In order to achieve maximum performance a few simple precautions should be observed.

### Digital Signal Levels

The LTC2492's digital interface is easy to use. Its digital inputs SDI,  $F_0$ ,  $\overline{\text{CS}}$ , and SCK (in external serial clock mode) accept standard CMOS logic levels. Internal hysteresis circuits can tolerate edge transition times as slow as 100 $\mu$ s.

The digital input signal range is 0.5V to  $V_{\text{CC}} - 0.5\text{V}$ . During transitions, the CMOS input circuits draw dynamic current. For optimal performance, application of signals to the serial data interface should be reserved for the sleep and data output periods.

During the conversion period, overshoot and undershoot of fast digital signals applied to both the serial digital interface and the external oscillator pin ( $F_0$ ) may degrade the converter performance. Undershoot and overshoot occur due to impedance mismatch of the circuit board trace at the converter pin when the transition time of an external control signal is less than twice the propagation delay from the driver to the input pin. For reference, on a regular FR-4 board, the propagation delay is approximately 183ps/inch. In order to prevent overshoot, a driver with a 1ns transition time must be connected to the converter through a trace shorter than 2.5 inches. This becomes difficult when shared control lines are used and multiple reflections occur.

Parallel termination near the input pin of the LTC2492 will eliminate this problem, but will increase the driver power dissipation. A series resistor from 27 $\Omega$  to 54 $\Omega$  (depending on the trace impedance and connection) placed near the driver will also eliminate over/under shoot without additional driver power dissipation.

For many applications, the serial interface pins (SCK, SDI,  $\overline{\text{CS}}$ ,  $F_0$ ) remain static during the conversion cycle and no degradation occurs. On the other hand, if an external oscillator is used ( $F_0$  driven externally) it is active during the conversion cycle. Moreover, the digital filter rejection is minimal at the clock rate applied to  $F_0$ . Care must be taken to ensure external inputs and reference lines do not cross this signal or run near it. These issues are avoided when using the internal oscillator.

## APPLICATIONS INFORMATION

### Driving the Input and Reference

The input and reference pins of the LTC2492 are connected directly to a switched capacitor network. Depending on the relationship between the differential input voltage and the differential reference voltage, these capacitors are switched between these four pins. Each time a capacitor is switched between two of these pins, a small amount of charge is transferred. A simplified equivalent circuit is shown in Figure 12.

When using the LTC2492's internal oscillator, the input capacitor array is switched at 123kHz. The effect of the charge transfer depends on the circuitry driving the input/reference pins. If the total external RC time constant is less than 580ns the errors introduced by the sampling process are negligible since complete settling occurs.

Typically, the reference inputs are driven from a low impedance source. In this case, complete settling occurs even with large external bypass capacitors. The inputs (CH0 to CH3, COM), on the other hand, are typically driven from larger source resistances. Source resistances up to 10k may interface directly to the LTC2492 and settle completely; however, the addition of external capacitors at the input

terminals in order to filter unwanted noise (anti-aliasing) results in incomplete settling.

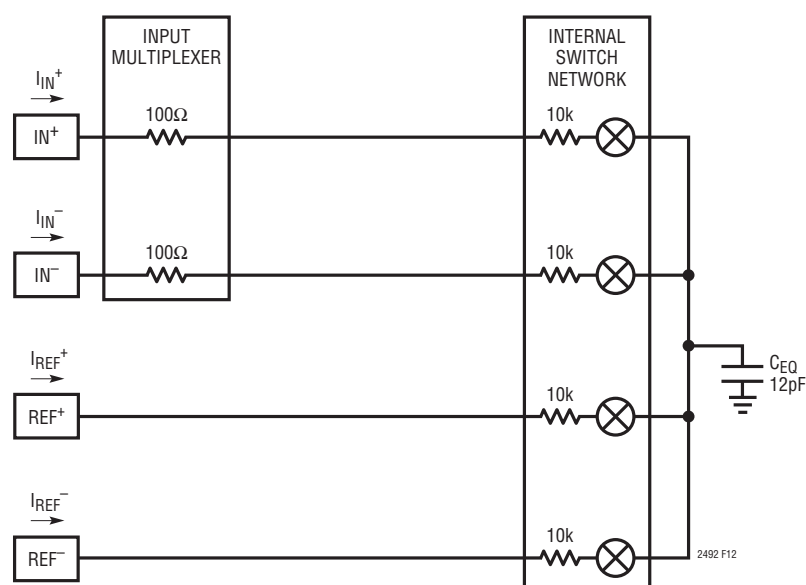
### Automatic Differential Input Current Cancellation

In applications where the sensor output impedance is low (up to 10kΩ with no external bypass capacitor or up to 500Ω with 0.001μF bypass), complete settling of the input occurs. In this case, no errors are introduced and direct digitization is possible.

For many applications, the sensor output impedance combined with external input bypass capacitors produces RC time constants much greater than the 580ns required for 1ppm accuracy. For example, a 10kΩ bridge driving a 0.1μF capacitor has a time constant an order of magnitude greater than the required maximum.

The LTC2492 uses a proprietary switching algorithm that forces the average differential input current to zero independent of external settling errors. This allows direct digitization of high impedance sensors without the need of buffers.

The switching algorithm forces the average input current on the positive input ( $I_{IN}^+$ ) to be equal to the average input current on the negative input ( $I_{IN}^-$ ). Over the complete



SWITCHING FREQUENCY  
 $f_{SW} = 123\text{kHz}$  INTERNAL OSCILLATOR  
 $f_{SW} = 0.4 \cdot f_{EOSC}$  EXTERNAL OSCILLATOR

$$I_{AVG}^{(IN^+)} = I_{AVG}^{(IN^-)} = \frac{V_{IN(CM)} - V_{REF(CM)}}{0.5 \cdot R_{EQ}}$$

$$I_{AVG}^{(REF^+)} \approx \frac{1.5V_{REF} + (V_{REF(CM)} - V_{IN(CM)})}{0.5 \cdot R_{EQ}} - \frac{V_{IN}^2}{V_{REF} \cdot R_{EQ}}$$

where:

$$V_{REF} = REF^+ - REF^-$$

$$V_{REF(CM)} = \left( \frac{REF^+ + REF^-}{2} \right)$$

$$V_{IN} = IN^+ - IN^-, \text{ WHERE } IN^+ \text{ AND } IN^- \text{ ARE THE SELECTED INPUT CHANNELS}$$

$$V_{IN(CM)} = \left( \frac{IN^+ + IN^-}{2} \right)$$

$$R_{EQ} = 2.71\text{M}\Omega \text{ INTERNAL OSCILLATOR } 60\text{Hz MODE}$$

$$R_{EQ} = 2.98\text{M}\Omega \text{ INTERNAL OSCILLATOR } 50\text{Hz}/60\text{Hz MODE}$$

$$R_{EQ} = (0.833 \cdot 10^{12}) / f_{EOSC} \text{ EXTERNAL OSCILLATOR}$$

Figure 12. LTC2492 Equivalent Analog Input Circuit

**APPLICATIONS INFORMATION**

conversion cycle, the average differential input current ( $I_{IN^+} - I_{IN^-}$ ) is zero. While the differential input current is zero, the common mode input current ( $(I_{IN^+} + I_{IN^-})/2$ ) is proportional to the difference between the common mode input voltage ( $V_{IN(CM)}$ ) and the common mode reference voltage ( $V_{REF(CM)}$ ).

In applications where the input common mode voltage is equal to the reference common mode voltage, as in the case of a balanced bridge, both the differential and common mode input currents are zero. The accuracy of the converter is not compromised by settling errors.

In applications where the input common mode voltage is constant but different from the reference common mode voltage, the differential input current remains zero while the common mode input current is proportional to the difference between  $V_{IN(CM)}$  and  $V_{REF(CM)}$ . For a reference common mode voltage of 2.5V and an input common mode of 1.5V, the common mode input current is approximately 0.74 $\mu$ A. This common mode input current does not degrade the accuracy if the source impedances tied to  $IN^+$  and  $IN^-$  are matched. Mismatches in source impedance lead to a fixed offset error but do not effect the linearity or full scale reading. A 1% mismatch in a 1k source resistance leads to a 74 $\mu$ V shift in offset voltage.

In applications where the common mode input voltage varies as a function of the input signal level (single-ended type sensors), the common mode input current varies proportionally with input voltage. For the case of balanced input impedances, the common mode input current effects are rejected by the large CMRR of the LTC2492, leading to little degradation in accuracy. Mismatches in source impedances lead to gain errors proportional to the difference between the common mode input and common mode reference. 1% mismatches in 1k source resistances lead to gain errors on the order of 15ppm. Based on the stability of the internal sampling capacitors and the accuracy of the internal oscillator, a one-time calibration will remove this error.

In addition to the input sampling current, the input ESD protection diodes have a temperature dependent leakage current. This current, nominally 1nA ( $\pm 10$ nA Max), results in a small offset shift. A 1k source resistance will create a 1 $\mu$ V typical and a 10 $\mu$ V maximum offset voltage.

**Reference Current**

Similar to the analog inputs, the LTC2492 samples the differential reference pins ( $REF^+$  and  $REF^-$ ) transferring small amounts of charge to and from these pins, thus producing a dynamic reference current. If incomplete settling occurs (as a function the reference source resistance and reference bypass capacitance) linearity and gain errors are introduced.

For relatively small values of external reference capacitance ( $C_{REF} < 1$ nF), the voltage on the sampling capacitor settles for reference impedances of many k $\Omega$  (if  $C_{REF} = 100$ pF up to 10k $\Omega$  will not degrade the performance) (see Figures 13 and 14).

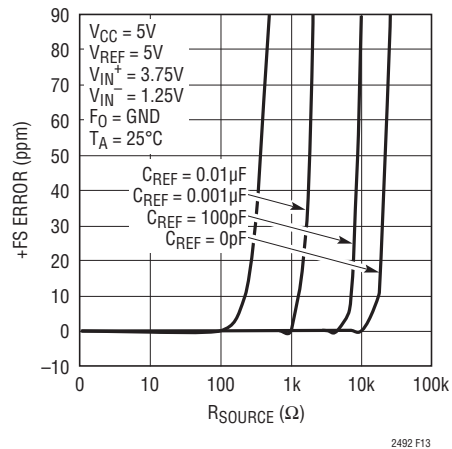


Figure 13. +FS Error vs  $R_{SOURCE}$  at  $V_{REF}$  (Small  $C_{REF}$ )

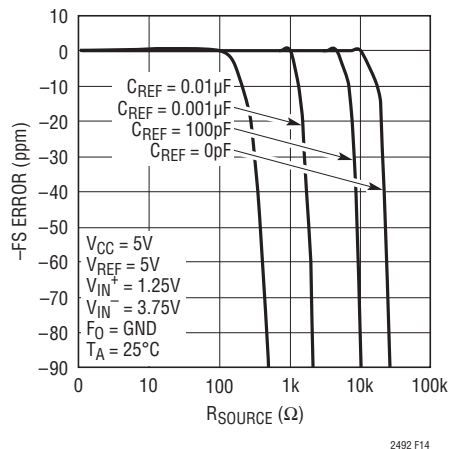


Figure 14. -FS Error vs  $R_{SOURCE}$  at  $V_{REF}$  (Small  $C_{REF}$ )



## APPLICATIONS INFORMATION

In cases where large bypass capacitors are required on the reference inputs ( $C_{REF} > 0.01\mu\text{F}$ ) full-scale and linearity errors are proportional to the value of the reference resistance. Every ohm of reference resistance produces a full-scale error of approximately 0.5ppm (while operating in simultaneous 50Hz/60Hz mode) (see Figures 15 and 16). If the input common mode voltage is equal to the reference common mode voltage, a linearity error of approximately 0.67ppm per 100 $\Omega$  of reference resistance results (see Figure 17). In applications where the input and reference

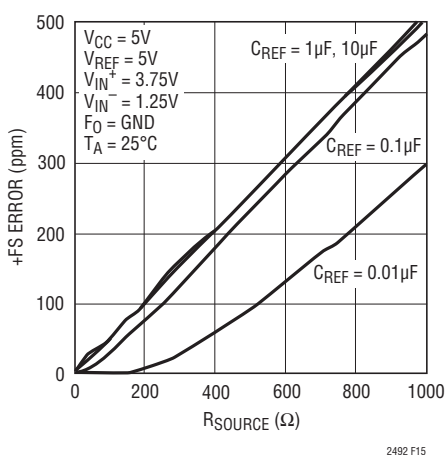


Figure 15. +FS Error vs  $R_{SOURCE}$  at  $V_{REF}$  (Large  $C_{REF}$ )

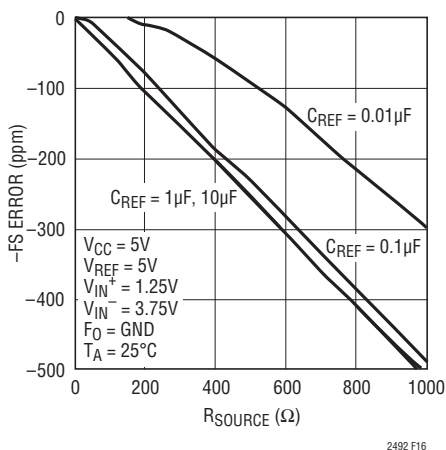


Figure 16. -FS Error vs  $R_{SOURCE}$  at  $V_{REF}$  (Large  $C_{REF}$ )

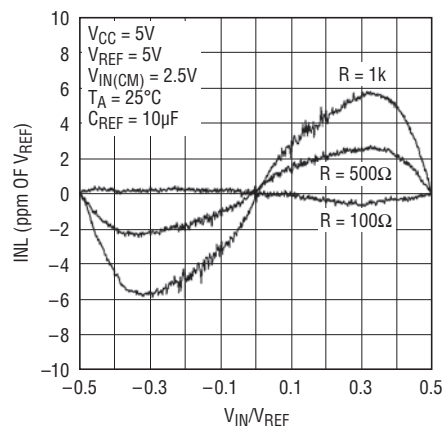


Figure 17. INL vs Differential Input Voltage and Reference Source Resistance for  $C_{REF} > 1\mu\text{F}$

common mode voltages are different, the errors increase. A 1V difference in between common mode input and common mode reference results in a 6.7ppm INL error for every 100 $\Omega$  of reference resistance.

In addition to the reference sampling charge, the reference ESD protection diodes have a temperature dependent leakage current. This leakage current, nominally 1nA ( $\pm 10\text{nA}$  max) results in a small gain error. A 100 $\Omega$  reference resistance will create a 0.5 $\mu\text{V}$  full scale error.

### Normal Mode Rejection and Anti-aliasing

One of the advantages delta-sigma ADCs offer over conventional ADCs is on-chip digital filtering. Combined with a large oversample ratio, the LTC2492 significantly simplifies anti-aliasing filter requirements. Additionally, the input current cancellation feature allows external low pass filtering without degrading the DC performance of the device.



## APPLICATIONS INFORMATION

The SINC<sup>4</sup> digital filter provides excellent normal mode rejection at all frequencies except DC and integer multiples of the modulator sampling frequency ( $f_S$ ) (see Figures 18 and 19). The modulator sampling frequency is  $f_S = 15,360\text{Hz}$  while operating with its internal oscillator and  $f_S = F_{EOSC}/20$  when operating with an external oscillator of frequency  $F_{EOSC}$ .

When using the internal oscillator, the LTC2492 is designed to reject line frequencies. As shown in Figure 20, rejection nulls occur at multiples of frequency  $f_N$ , where  $f_N$  is

determined by the input control bits FA and FB ( $f_N = 50\text{Hz}$  or  $60\text{Hz}$  or  $55\text{Hz}$  for simultaneous rejection). Multiples of the modulator sampling rate ( $f_S = f_N \cdot 256$ ) only reject noise to 15dB (see Figure 21); if noise sources are present at these frequencies anti-aliasing will reduce their effects.

The user can expect to achieve this level of performance using the internal oscillator, as shown in Figures 22, 23, and 24. Measured values of normal mode rejection are shown superimposed over the theoretical values in all three rejection modes.

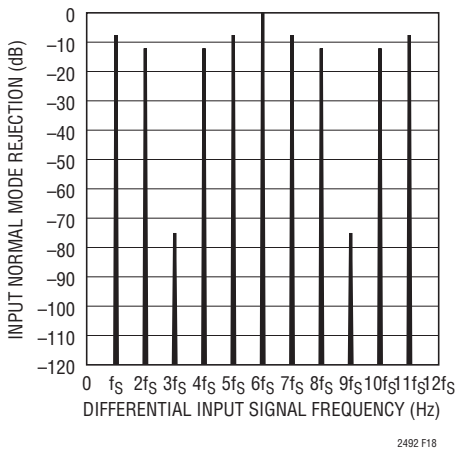


Figure 18. Input Normal Mode Rejection, Internal Oscillator and 50Hz Rejection Mode

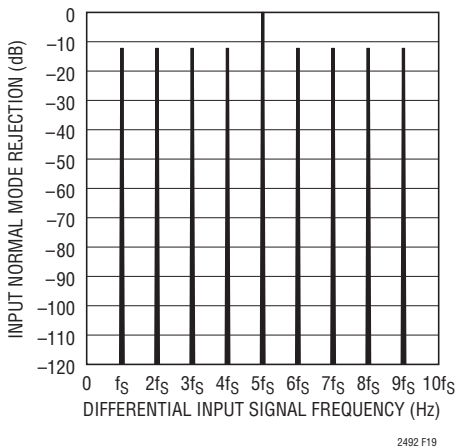


Figure 19. Input Normal Mode Rejection, Internal Oscillator and 60Hz Rejection Mode

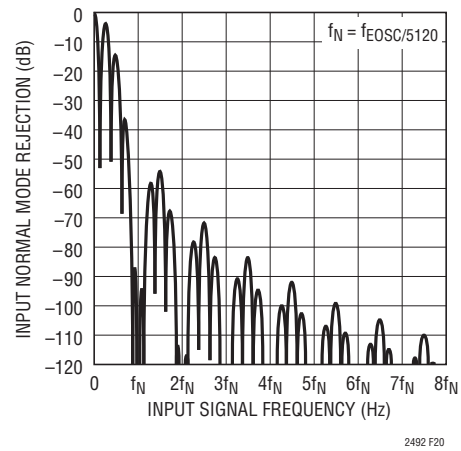


Figure 20. Input Normal Mode Rejection at DC

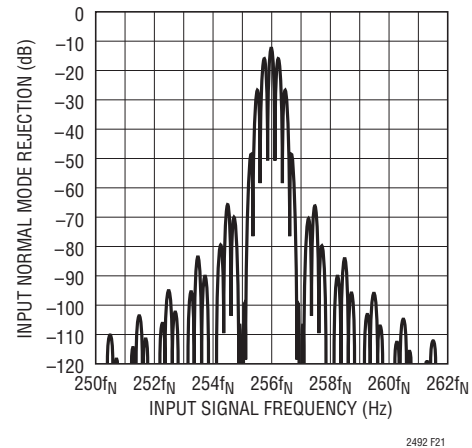
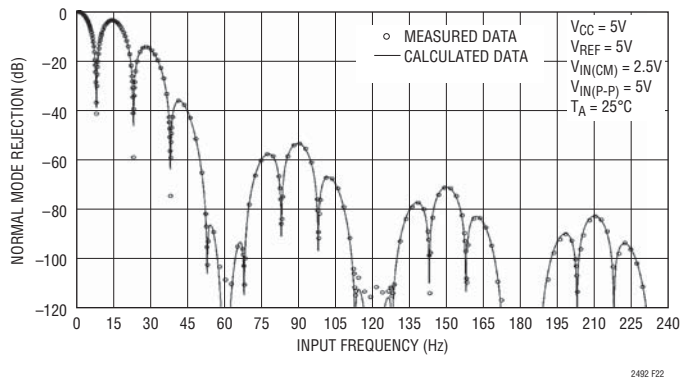
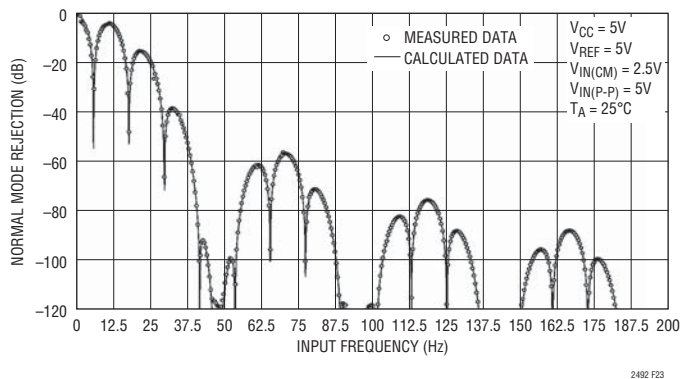


Figure 21. Input Normal Mode Rejection at  $f_S = 256 \cdot f_N$

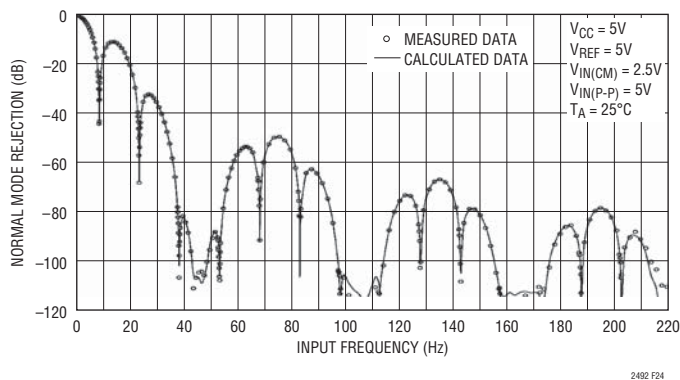
## APPLICATIONS INFORMATION



**Figure 22. Input Normal Mode Rejection vs Input Frequency with Input Perturbation of 100% (60Hz Notch)**

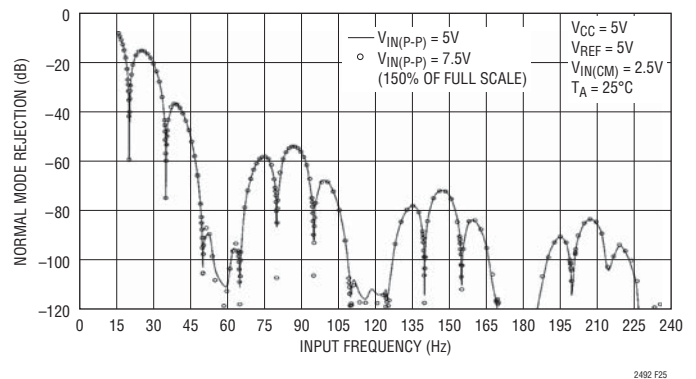


**Figure 23. Input Normal Mode Rejection vs Input Frequency with Input Perturbation of 100% (50Hz Notch)**

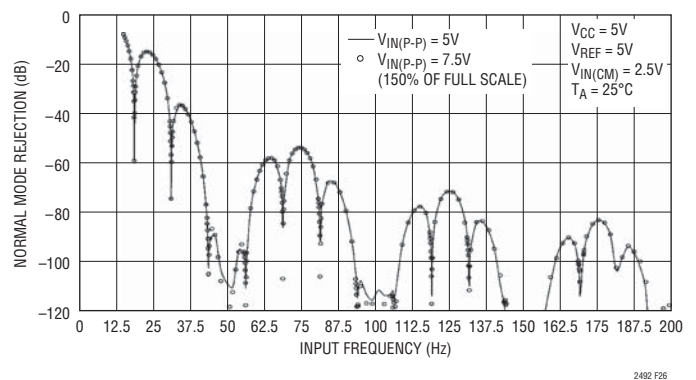


**Figure 24. Input Normal Mode Rejection vs Input Frequency with Input Perturbation of 100% (50Hz/60Hz Notch)**

Traditional high order delta-sigma modulators suffer from potential instabilities at large input signal levels. The proprietary architecture used for the LTC2492 third order modulator resolves this problem and guarantees stability with input signals 150% of full-scale. In many industrial applications, it is not uncommon to have microvolt level signals superimposed over unwanted error sources with several volts of peak-to-peak noise. Figures 25 and 26 show measurement results for the rejection of a 7.5V peak-to-peak noise source (150% of full scale) applied to the LTC2492. From these curves, it is shown that the rejection performance is maintained even in extremely noisy environments.



**Figure 25. Measure Input Normal Mode Rejection vs Input Frequency with Input Perturbation of 150% (60Hz Notch)**



**Figure 26. Measure Input Normal Mode Rejection vs Input Frequency with input Perturbation of 150% (50Hz Notch)**

## APPLICATIONS INFORMATION

Using the 2x speed mode of the LTC2492 alters the rejection characteristics around DC and multiples of  $f_S$ . The device bypasses the offset calibration in order to increase the output rate. The resulting rejection plots are shown in Figures 27 and 28. 1x type frequency rejection can be achieved using the 2x mode by performing a running average of the conversion results (see Figure 29).

### Output Data Rate

When using its internal oscillator, the LTC2492 produces up to 7.5 samples per second (sps) with a notch frequency of 60Hz. The actual output data rate depends upon the length of the sleep and data output cycles which are controlled by the user and can be made insignificantly short. When operating with an external conversion clock ( $F_O$  connected to an external oscillator), the LTC2492 output data rate can be increased. The duration of the conversion cycle is  $41036/f_{EOSC}$ . If  $f_{EOSC} = 307.2\text{kHz}$ , the converter behaves as if the internal oscillator is used.

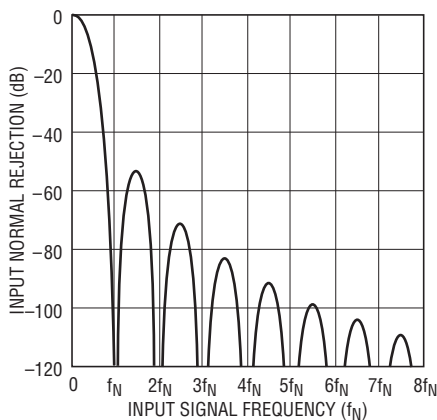
An increase in  $f_{EOSC}$  over the nominal 307.2kHz will translate into a proportional increase in the maximum output data rate (up to a maximum of 100sps). The increase in output

rate leads to degradation in offset, full-scale error, and effective resolution as well as a shift in frequency rejection. When using the integrated temperature sensor, the internal oscillator should be used or an external oscillator,  $f_{EOSC} = 307.2\text{kHz}$  maximum.

A change in  $f_{EOSC}$  results in a proportional change in the internal notch position. This leads to reduced differential mode rejection of line frequencies. The common mode rejection of line frequencies remains unchanged, thus fully differential input signals with a high degree of symmetry on both the  $IN^+$  and  $IN^-$  pins will continue to reject line frequency noise.

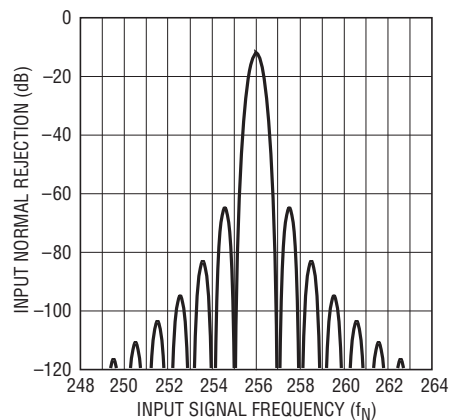
An increase in  $f_{EOSC}$  also increases the effective dynamic input and reference current. External RC networks will continue to have zero differential input current, but the time required for complete settling (580ns for  $f_{EOSC} = 307.2\text{kHz}$ ) is reduced, proportionally.

Once the external oscillator frequency is increased above 1MHz (a more than 3x increase in output rate) the effectiveness of internal auto calibration circuits begins to degrade. This results in larger offset errors, full scale errors, and decreased resolution (see Figures 30 to 37).



2492 F27

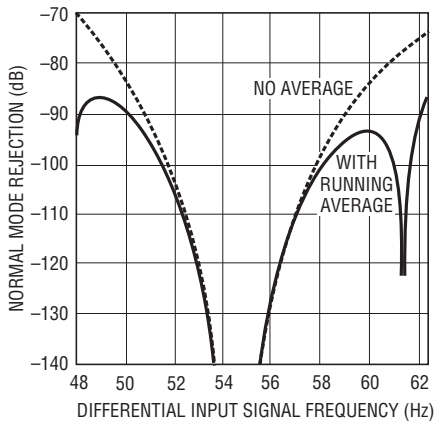
Figure 27. Input Normal Mode Rejection 2x Speed Mode



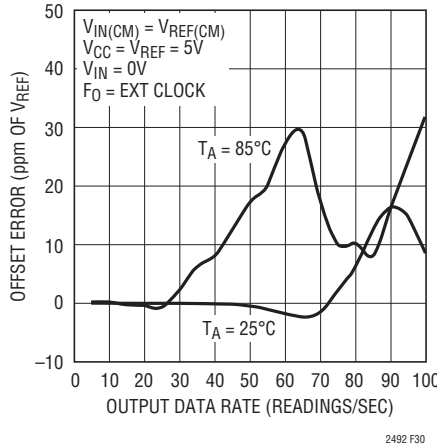
2492 F28

Figure 28. Input Normal Mode Rejection 2x Speed Mode

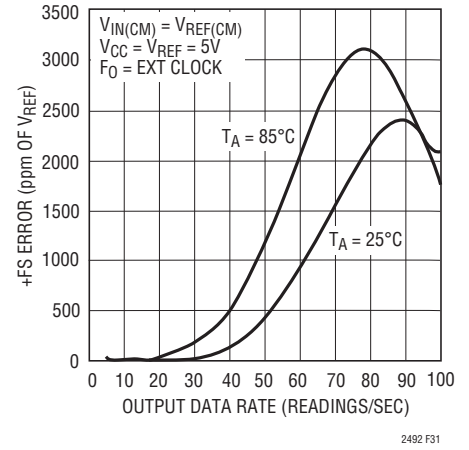
# APPLICATIONS INFORMATION



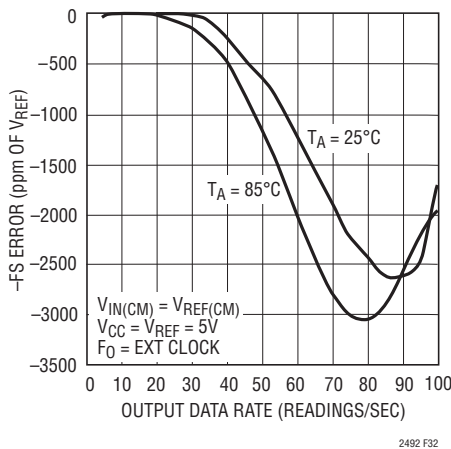
**Figure 29. Input Normal Mode Rejection 2x Speed Mode with and Without Running Averaging**



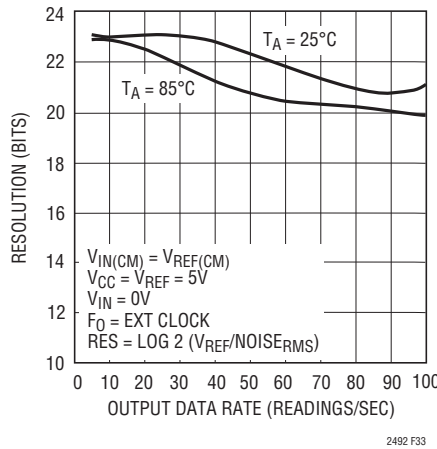
**Figure 30. Offset Error vs Output Data Rate and Temperature**



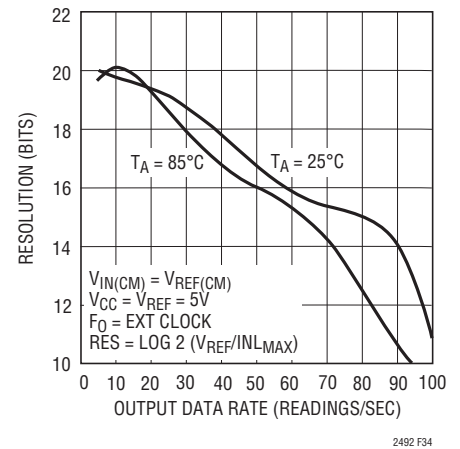
**Figure 31. +FS Error vs Output Data Rate and Temperature**



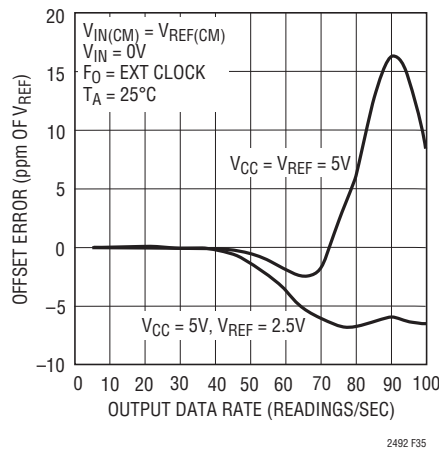
**Figure 32. -FS Error vs Output Data Rate and Temperature**



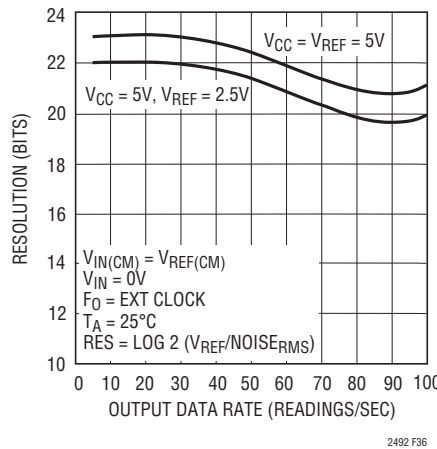
**Figure 33. Resolution ( $\text{Noise}_{\text{RMS}} \leq 1\text{LSB}$ ) vs Output Data Rate and Temperature**



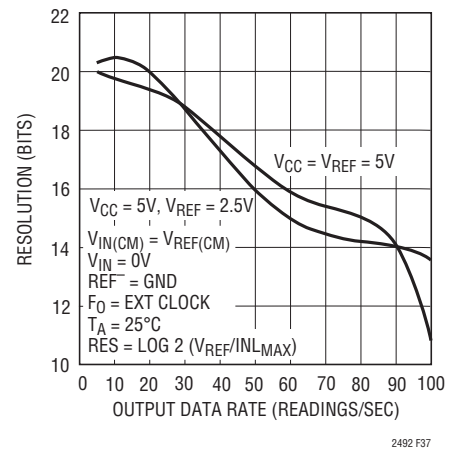
**Figure 34. Resolution ( $\text{INL}_{\text{MAX}} \leq 1\text{LSB}$ ) vs Output Data Rate and Temperature**



**Figure 35. Offset Error vs Output Data Rate and Reference Voltage**



**Figure 36. Resolution ( $\text{Noise}_{\text{RMS}} \leq 1\text{LSB}$ ) vs Output Data Rate and Reference Voltage**



**Figure 37. Resolution ( $\text{INL}_{\text{MAX}} \leq 1\text{LSB}$ ) vs Output Data Rate and Reference Voltage**

## APPLICATIONS INFORMATION

### Easy Drive ADCs Simplify Measurement of High Impedance Sensors

Delta-Sigma ADCs, with their high accuracy and high noise immunity, are ideal for directly measuring many types of sensors. Nevertheless, input sampling currents can overwhelm high source impedances or low-bandwidth, micropower signal conditioning circuits. The LTC2492 solves this problem by balancing the input currents, thus simplifying or eliminating the need for signal conditioning circuits.

A common application for a delta-sigma ADC is thermistor measurement. Figure 38 shows two examples of thermistor digitization benefiting from the Easy Drive technology.

The first circuit (applied to input channels CH0 and CH1) uses balanced reference resistors in order to balance the common mode input/reference voltage and balance the differential input source resistance. If reference resistors R1 and R4 are exactly equal, the input current is zero and no errors result. If these resistors have a 1% tolerance, the maximum error in measured resistance is  $1.6\Omega$  due to a shift in common mode voltage; far less than the 1%

error of the reference resistors themselves. No amplifier is required, making this an ideal solution in micropower applications.

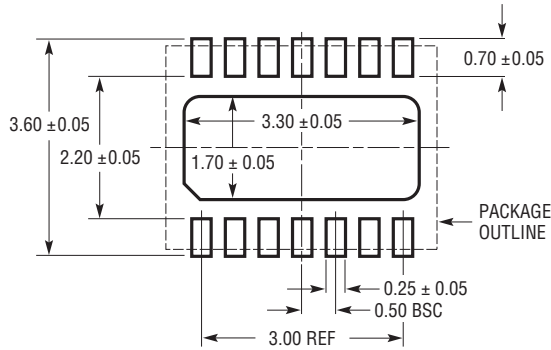
Easy Drive also enables very low power, low bandwidth amplifiers to drive the input to the LTC2492. As shown in Figure 38, CH2 is driven by the LT1494. The LT1494 has excellent DC specs for an amplifier with  $1.5\mu\text{A}$  supply current (the maximum offset voltage is  $150\mu\text{V}$  and the open loop gain is 100,000). Its 2kHz bandwidth makes it unsuitable for driving conventional delta sigma ADCs. Adding a  $1\text{k}\Omega$ ,  $0.1\mu\text{F}$  filter solves this problem by providing a charge reservoir that supplies the LTC2492 instantaneous current, while the 1k resistor isolates the capacitive load from the LT1494.

Conventional delta sigma ADCs input sampling current lead to DC errors as a result of incomplete settling in the external RC network.

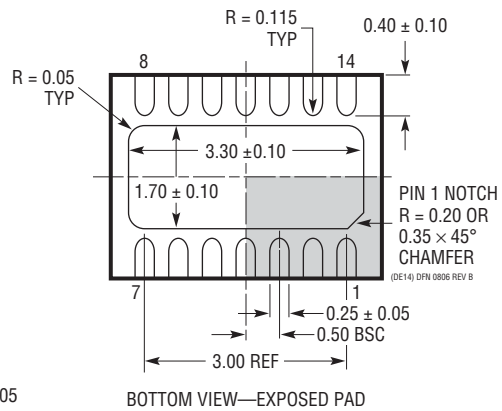
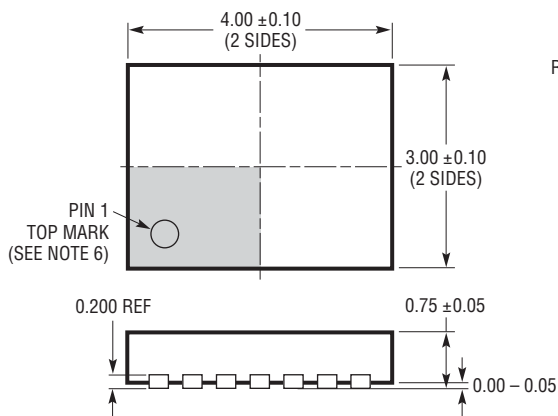
The Easy Drive technology cancels the differential input current. By balancing the negative input (CH3) with a  $1\text{k}\Omega$ ,  $0.1\mu\text{F}$  network errors due to the common mode input current are cancelled.

# PACKAGE DESCRIPTION

**DE Package**  
**14-Lead Plastic DFN (4mm × 3mm)**  
 (Reference LTC DWG # 05-08-1708 Rev A)



RECOMMENDED SOLDER PAD PITCH AND DIMENSIONS  
 APPLY SOLDER MASK TO AREAS THAT ARE NOT SOLDERED



- NOTE:
1. DRAWING PROPOSED TO BE MADE VARIATION OF VERSION (WGED-3) IN JEDEC PACKAGE OUTLINE MO-229
  2. DRAWING NOT TO SCALE
  3. ALL DIMENSIONS ARE IN MILLIMETERS
  4. DIMENSIONS OF EXPOSED PAD ON BOTTOM OF PACKAGE DO NOT INCLUDE MOLD FLASH. MOLD FLASH, IF PRESENT, SHALL NOT EXCEED 0.15mm ON ANY SIDE
  5. EXPOSED PAD SHALL BE SOLDER PLATED
  6. SHADED AREA IS ONLY A REFERENCE FOR PIN 1 LOCATION ON THE TOP AND BOTTOM OF PACKAGE

## TYPICAL APPLICATION

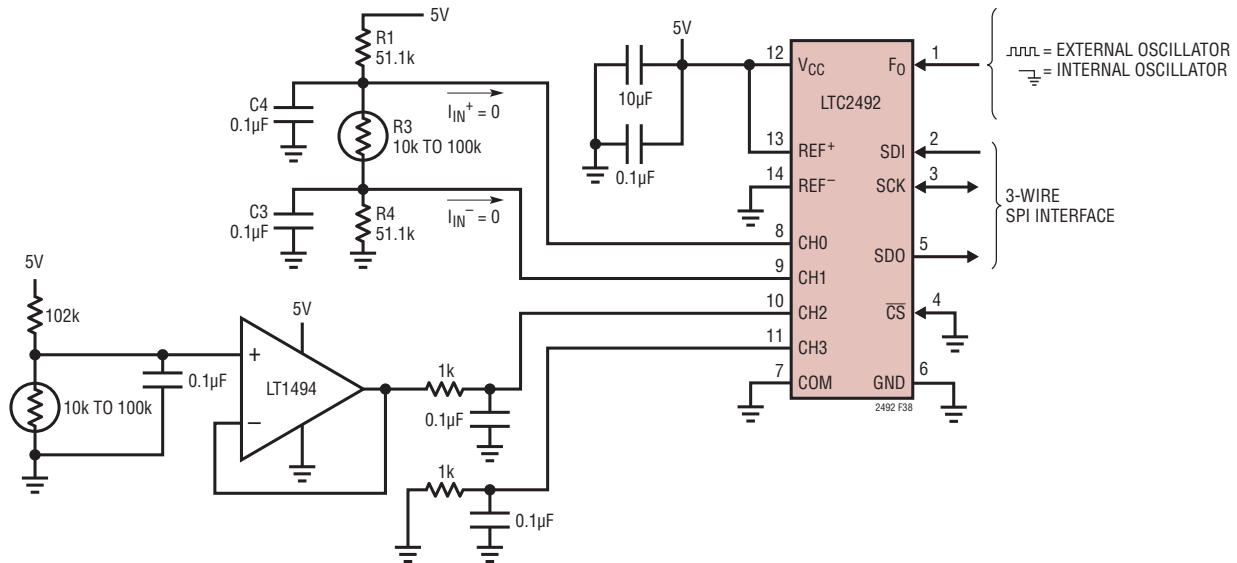


Figure 38. Easy Drive ADCs Simplify Measurement of High Impedance Sensors

## RELATED PARTS

PART NUMBER	DESCRIPTION	COMMENTS
LT1236A-5	Precision Bandgap Reference, 5V	0.05% Max Initial Accuracy, 5ppm/°C Drift
LT1460	Micropower Series Reference	0.075% Max Initial Accuracy, 10ppm/°C Max Drift
LT1790	Micropower SOT-23 Low Dropout Reference Family	0.05% Max Initial Accuracy, 10ppm/°C Max Drift
LTC2400	24-Bit, No Latency $\Delta\Sigma$ ADC in SO-8	0.3ppm Noise, 4ppm INL, 10ppm Total Unadjusted Error, 200μA
LTC2410	24-Bit, No Latency $\Delta\Sigma$ ADC with Differential Inputs	0.8μV <sub>RMS</sub> Noise, 2ppm INL
LTC2411/ LTC2411-1	24-Bit, No Latency $\Delta\Sigma$ ADCs with Differential Inputs in MSOP	1.45μV <sub>RMS</sub> Noise, 4ppm INL, Simultaneous 50Hz/60Hz Rejection (LTC2411-1)
LTC2413	24-Bit, No Latency $\Delta\Sigma$ ADC with Differential Inputs	Simultaneous 50Hz/60Hz Rejection, 800nV <sub>RMS</sub> Noise
LTC2440	High Speed, Low Noise 24-Bit $\Delta\Sigma$ ADC	3.5kHz Output Rate, 200nV Noise, 24.6 ENOBs
LTC2442	24-Bit, High Speed 2-Channel and 4-Channel $\Delta\Sigma$ ADC with Integrated Amplifier	8kHz Output Rate, 220nV Noise, Simultaneous 50Hz/60Hz Rejection
LTC2449	24-Bit, High Speed 8-Channel and 16-Channel $\Delta\Sigma$ ADC	8kHz Output Rate, 200nV Noise, Simultaneous 50Hz/60Hz Rejection
LTC2480	16-Bit $\Delta\Sigma$ ADC with Easy Drive Inputs, 600nV Noise, Programmable Gain, and Temperature Sensor	Pin Compatible with LTC2482/LTC2484
LTC2481	16-Bit $\Delta\Sigma$ ADC with Easy Drive Inputs, 600nV Noise, I <sup>2</sup> C Interface, Programmable Gain, and Temperature Sensor	Pin Compatible with LTC2483/LTC2485
LTC2482	16-Bit $\Delta\Sigma$ ADC with Easy Drive Inputs	Pin Compatible with LTC2480/LTC2484
LTC2483	16-Bit $\Delta\Sigma$ ADC with Easy Drive Inputs, and I <sup>2</sup> C Interface	Pin Compatible with LTC2481/LTC2485
LTC2484	24-Bit $\Delta\Sigma$ ADC with Easy Drive Inputs	Pin Compatible with LTC2480/LTC2482
LTC2485	24-Bit $\Delta\Sigma$ ADC with Easy Drive Inputs, I <sup>2</sup> C Interface, and Temperature Sensor	Pin Compatible with LTC2481/LTC2483
LTC2488	2-Channel and 4-Channel 16-Bit $\Delta\Sigma$ ADC with Easy Drive Inputs	Pin Compatible with LTC2492
LTC2496/ LTC2498	16-Channel/8-Channel 16-Bit/24-Bit $\Delta\Sigma$ ADC with Easy Drive Inputs, and SPI Interface	Timing Compatible with LTC2492