

Chip Monolithic Ceramic Capacitors for Automotive

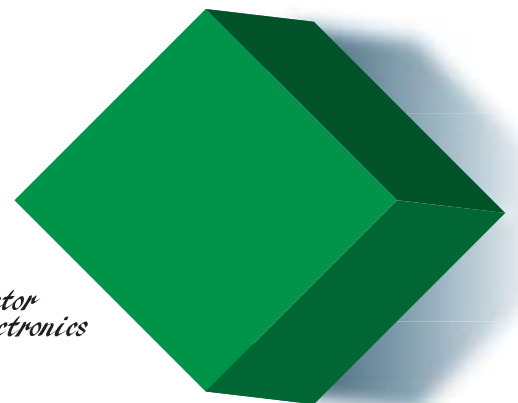
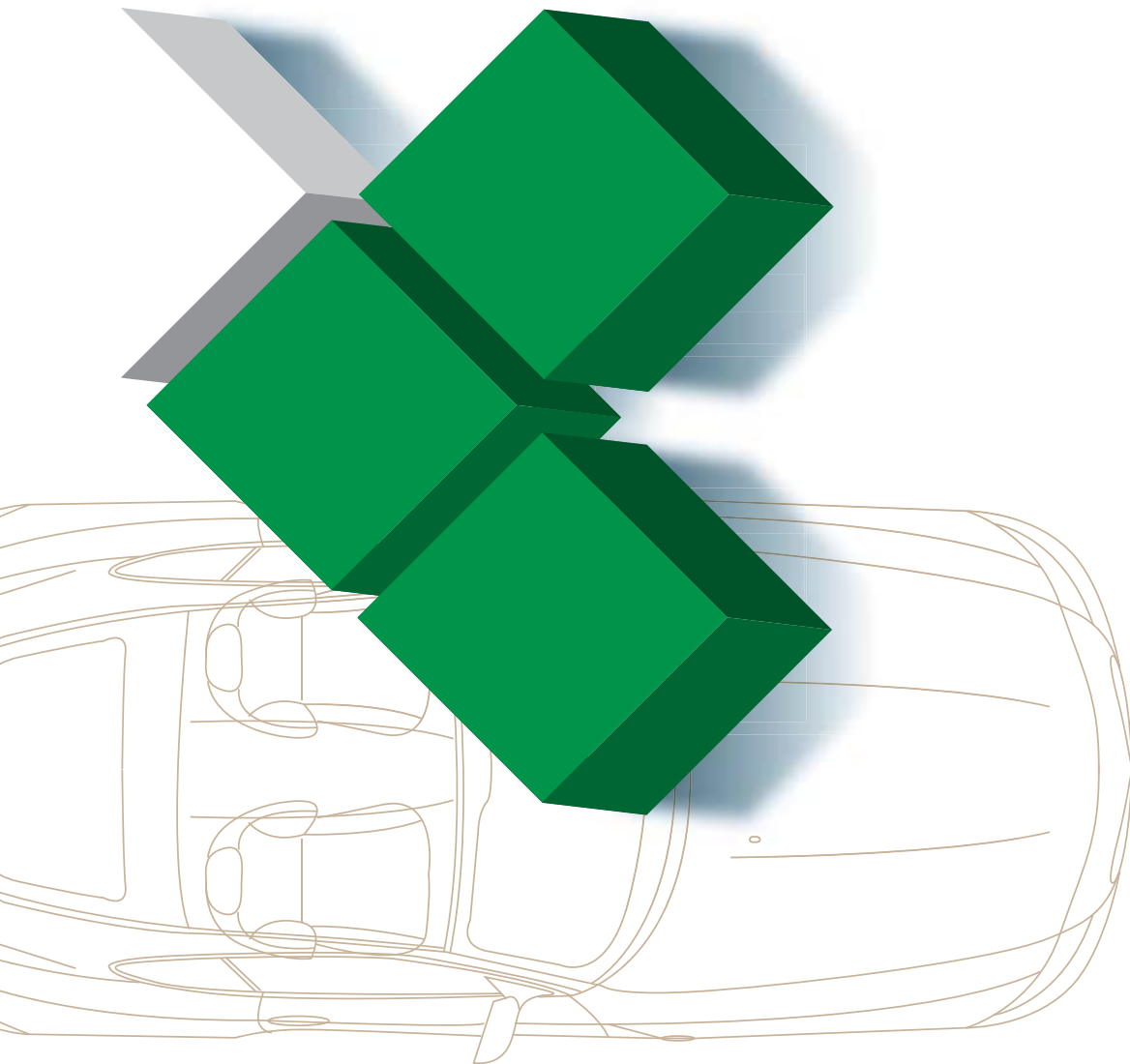

muRata

Murata
Manufacturing Co., Ltd.

*Innovator
in Electronics*

Explanation of Symbols in This Catalog

Ultra-compact

L x W dimension: products of 0.6x0.3 mm or less

AEC-Q200

AEC-Q200 compliant product

Anti-noise

Product suitable for acoustic noise reduction and low distortion
This product suppresses acoustic noise, which occurs when a ceramic capacitor is used, by devising the materials and configuration.

Fail safe

Fail safe product
This capacitor is designed to prevent failures as much as possible by short mode.

Deflecting crack

Product resistant to deflection cracking
This capacitor is designed to prevent failures as much as possible by short mode caused by cracking when there is board deflection.

Soldering crack

Product with solder cracking suppression
This capacitor is configured with metal terminals or lead wires connected to the chip.
The metal terminals or lead wires relieve the stress from expansion and contraction of the solder, to suppress solder cracking.
Also, including capacitor which can be mounted with a conductive adhesive, instead of soldering.

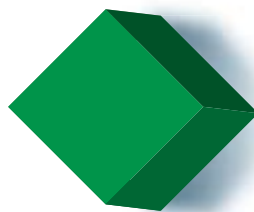
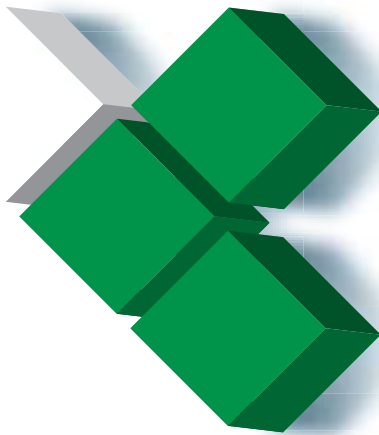

EU RoHS Compliant

- All the products in this catalog comply with EU RoHS.
- EU RoHS is "the European Directive 2011/65/EU on the Restriction of the Use of Certain Hazardous Substances in Electrical and Electronic Equipment."
- For more details, please refer to our website 'Murata's Approach for EU RoHS' (<http://www.murata.com/info/rohs.html>).

Contents

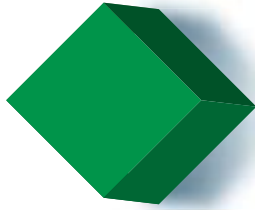

Product specifications are as of March 2013.

Part Numbering	p2
Selection Guide	p4
Capacitance Table	p5

Chip Monolithic Ceramic Capacitors for Automotive

Cap. Table

General Purpose Product GCM Series	p16	p6
---	-----	----

Resin External Electrode Product GCJ Series	p23	p10
--	-----	-----

Specially Designed Product to Reduce Shorts GCD Series	p28	p12
---	-----	-----

Specially Designed Product to Reduce Shorts & Resin Electrode Product GCE Series	p30	p12
--	-----	-----

Conductivity Adhesive Compatible Type GCG Series	p32	p13
---	-----	-----

High Effective Capacitance & High Allowable Ripple Current GC3 Series	p36	p14
---	-----	-----

Metal Terminal Type KCM Series	p38	p14
--------------------------------------	-----	-----

Metal Terminal Type/High Effective Capacitance & High Allowable Ripple Current KC3 Series	p41	p14
---	-----	-----

⚠Caution/Notice	p44
Introduction of Website SimSurfing	p62
EMICON-FUN!	p63
Product Information	p64

Please check the MURATA home page (<http://www.murata.com/>) if you cannot find the part number in the catalog.

● Part Numbering

Chip Monolithic Ceramic Capacitors for Automotive

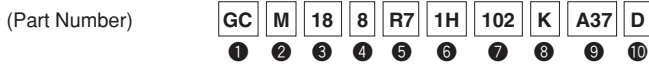

① Product ID

② Series

Product ID	Code	Series
GC	3	High effective capacitance & High allowable ripple current
	D	Specially designed product to reduce shorts
	E	Specially designed product to reduce shorts & resin electrode product
	G	Conductivity adhesive compatible type
	J	Resin external electrode product
	M	For automotive
KC	3	Metal terminal type/High effective capacitance & High allowable ripple current
	M	Metal terminal type

③ Chip Dimension (L×W)

Code	Dimension (L×W)	EIA
03	0.6×0.3mm	0201
15	1.0×0.5mm	0402
18	1.6×0.8mm	0603
21	2.0×1.25mm	0805
31	3.2×1.6mm	1206
32	3.2×2.5mm	1210
43	4.5×3.2mm	1812
55	5.7×5.0mm	2220

⑤ Temperature Characteristics

Temperature Characteristic Codes		Temperature Characteristics				Operating Temperature Range	Capacitance Change Each Temperature (%)					
		Reference Temperature	Temperature Range	Capacitance Change or Temperature Coefficient	-55°C		-25°C		-10°C			
					Max.		Min.	Max.	Min.	Max.	Min.	
0C	CHA *2	20°C	20 to 150°C	0±60ppm/°C	-55 to 150°C	0.82	-0.45	0.49	-0.27	0.33	-0.18	
1C	CG	JIS	20°C	20 to 125°C	0±30ppm/°C	-55 to 125°C	0.54	-0.23	0.33	-0.14	0.22	-0.09
2C	CH	JIS	20°C	20 to 125°C	0±60ppm/°C	-55 to 125°C	0.82	-0.45	0.49	-0.27	0.33	-0.18
3C	CJ	JIS	20°C	20 to 125°C	0±120ppm/°C	-55 to 125°C	1.37	-0.9	0.82	-0.54	0.55	-0.36
4C	CK	JIS	20°C	20 to 125°C	0±250ppm/°C	-55 to 125°C	2.56	-1.88	1.54	-1.13	1.02	-0.75
5C	C0G	EIA	25°C	25 to 125°C	0±30ppm/°C	-55 to 125°C	0.58	-0.24	0.4	-0.17	0.25	-0.11
5G	X8G	*2	25°C	25 to 150°C	0±30ppm/°C	-55 to 150°C	0.58	-0.24	0.4	-0.17	0.25	-0.11
7U	U2J	EIA	25°C	25 to 125°C *3	-750±120ppm/°C	-55 to 125°C	8.78	5.04	6.04	3.47	3.84	2.21
C7	X7S	EIA	25°C	-55 to 125°C	±22%	-55 to 125°C	-	-	-	-	-	-
D7	X7T	EIA	25°C	-55 to 125°C	+22%, -33%	-55 to 125°C	-	-	-	-	-	-
L8	X8L	*2	25°C	-55 to 150°C	+15%, -40%	-55 to 150°C	-	-	-	-	-	-
R1	R *1	JIS	20°C	-55 to 125°C	±15%	-55 to 125°C	-	-	-	-	-	-
R7	X7R	EIA	25°C	-55 to 125°C	±15%	-55 to 125°C	-	-	-	-	-	-
R9	X8R	EIA	25°C	-55 to 150°C	±15%	-55 to 150°C	-	-	-	-	-	-

*1 Capacitance change is specified with 50% rated voltage applied.

*2 Murata Temperature Characteristic Code.

*3 Rated Voltage 100Vdc max: 25 to 85°C

④ Height Dimension (T) (Except KC□)

Code	Dimension (T)
3	0.3mm
5	0.5mm
6	0.6mm
8	0.8mm
9	0.85mm
A	1.0mm
B	1.25mm
C	1.6mm
D	2.0mm
E	2.5mm
M	1.15mm
N	1.35mm
Q	1.5mm
R	1.8mm
X	Depends on individual standards.

④ Height Dimension (T) (KC□ Only)

Code	Dimension (T)
L	2.8mm
Q	3.7mm
T	4.8mm
W	6.4mm

Continued on the following page.

☐ Continued from the preceding page.

⑥ Rated Voltage

Code	Rated Voltage
0J	DC6.3V
1A	DC10V
1C	DC16V
1E	DC25V
YA	DC35V
1H	DC50V
1J	DC63V
2A	DC100V
2E	DC250V
2W	DC450V
2J	DC630V
3A	DC1kV

⑦ Capacitance

Expressed by three-digit alphanumerics. The unit is pico-farad (pF). The first and second figures are significant digits, and the third figure expresses the number of zeros that follow the two numbers.

If there is a decimal point, it is expressed by the capital letter "R."

In this case, all figures are significant digits.

If any letter, other than "R" is included, this indicates the specific part number is a non-standard part.

Ex.)

Code	Capacitance
R50	0.50pF
1R0	1.0pF
100	10pF
103	10000pF

⑧ Capacitance Tolerance

Code	Capacitance Tolerance
B	±0.1pF
C	±0.25pF
D	±0.5pF
F	±1%
G	±2%
J	±5%
K	±10%
M	±20%
R	Depends on individual standards.
W	±0.05pF

⑨ Individual Specification Code

Expressed by three figures.

⑩ Package

Code	Package
L	ø180mm Embossed Taping
D/W	ø180mm Paper Taping
K	ø330mm Embossed Taping
J	ø330mm Paper Taping
B	Bulk
C	Bulk Case

Selection Guide for Chip Monolithic Ceramic Capacitors

Series	Ultra-small (smaller than 0201)	Low dissipation/HiQ	Low ESL	Fail safe	Anti-deflecting crack	Anti-soldering crack	Anti-noise, low distortion	For bonding	Capacitor array	For wide band decoupling	Specific applications	Safety standard certified type
For Automotive	GCM <small>page p16</small>											
	GCJ <small>p23</small>											
	GCD <small>p28</small>											
	GCE <small>p30</small>											
	GCG <small>p32</small>											
	GC3 <small>p36</small>											
	KCM <small>p38</small>											
	KC3 <small>p41</small>											
For General Purpose (Please refer to Cat. No. C02 for general purpose.)	GRM											
	GNM											
	LLL											
	LLR											
	LLA											
	LLM											
	GJM											
	GQM											
	GMA											
	GMD											
	GWM											
	GRJ											
	GR3											
	GR4											
	GR7											
	GJ4											
	GJ8											
	ZRA											
	KRM											
	KR3											
	GA2											
	GA3											

Capacitance Table

How to read the Capacitance Table

LxW (mm)	0.6× 0.3	1.0× 0.5	1.6×0.8		
T max. (mm)	0.33	0.55	0.9		
Rated Voltage (Vdc)	25	50	100	50	10
Cap. / TC Code	C0G	C0G	C0G	C0G	C0
1.0pF	p17	p17	p17	p17	
2.0pF	p17	p17	p17	p17	
3.0pF	p17	p17	p17	p17	
4.0pF	p17	p17	p17	p17	
5.0pF	p17	p17	p17	p17	

→ The values can be narrowed down in the order of size, rated voltage, and temperature characteristics.

→ Refers to the page of the part number list.
 Check the part number list for the applicable product number.

Temperature Characteristics Table

The Table is colored by temperature characteristic codes.
 Refer to the following Table for the meaning of each code.

EIA: C0G U2J X7R X7S X7T

Murata Temperature Characteristic: X8G X8L

Temperature Characteristic Codes		Temperature Characteristics			Operating Temperature Range	Capacitance Change Each Temperature (%)					
		Reference Temperature	Temperature Range	Capacitance Change or Temperature Coefficient		-55°C		-25°C		-10°C	
Public STD Code							Max.	Min.	Max.	Min.	Max.
X8G: Murata Temperature Characteristic		25°C	25 to 150°C	0±30ppm/°C	-55 to 150°C	0.58	-0.24	0.4	-0.17	0.25	-0.11
C0G	EIA	25°C	25 to 125°C	0±30ppm/°C	-55 to 125°C	0.58	-0.24	0.4	-0.17	0.25	-0.11
U2J	EIA	25°C	25 to 125°C	-750±120ppm/°C	-55 to 125°C	8.78	5.04	6.04	3.47	3.84	2.21
X7R	EIA	25°C	-55 to 125°C	±15%	-55 to 125°C	-	-	-	-	-	-
X7S	EIA	25°C	-55 to 125°C	±22%	-55 to 125°C	-	-	-	-	-	-
X7T	EIA	25°C	-55 to 125°C	+22%, -33%	-55 to 125°C	-	-	-	-	-	-
X8L: Murata Temperature Characteristic		25°C	-55 to 150°C	+15%, -40%	-55 to 150°C	-	-	-	-	-	-

Capacitance Table

p00

Each number in the Part Number List refers to the page number printed at the bottom of the page.

■ GCM Series Temperature Compensating Type

p00 ← Part Number List

EIA: C0G U2J

LxW (mm)	0.6x0.33		1.0x0.55		1.6x0.8		2.0x1.25						3.2x1.6						3.2x2.5								
	T max. (mm)	0.33	0.55	0.9	0.7	0.95	1.0	1.4	1.45	0.95	1.0	1.25	1.8	1.0	1.25	1.5	1.0	1.25	1.5								
Rated Voltage (Vdc)	25	50	100	50	100	50	50	250	50	250	100	50	1000	630	250	1000	630	250	50	1000	630	630	1000	630	1000	630	
Cap. / TC Code	C0G	C0G	C0G	C0G	C0G	C0G	U2J	C0G	U2J	C0G	C0G	U2J	U2J	U2J	U2J	U2J	U2J	U2J	C0G	U2J	U2J	U2J	U2J	U2J	U2J	U2J	
1.0pF	p17	p17	p17	p17																							
2.0pF	p17	p17	p17	p17																							
3.0pF	p17	p17	p17	p17																							
4.0pF	p17	p17	p17	p17																							
5.0pF	p17	p17	p17	p17																							
6.0pF	p17	p17	p17	p17																							
7.0pF	p17	p17	p17	p17																							
8.0pF	p17	p17	p17	p17																							
9.0pF	p17	p17	p17	p18																							
10pF	p17	p17	p17	p18									p19	p19													
12pF	p17	p17	p17	p18									p19	p19													
15pF	p17	p17	p17	p18									p19	p19													
18pF	p17	p17	p17	p18									p19	p19													
22pF	p17	p17	p17	p18									p19	p19													
27pF	p17	p17	p17	p18									p19	p19													
33pF	p17	p17	p17	p18									p19	p19													
39pF	p17	p17	p17	p18									p19	p19													
47pF	p17	p17	p17	p18									p19	p19													
56pF	p17	p17	p17	p18									p19	p19													
68pF	p17	p17	p17	p18									p19	p19													
82pF	p17	p17	p17	p18									p19	p19													
100pF	p17	p17	p17	p18	p18				p18				p19	p19													
120pF		p17	p17	p18	p18				p18				p19	p19													
150pF		p17	p17	p18	p18				p18				p19	p19													
180pF		p17	p17	p18	p18				p18				p19	p19													
220pF		p17	p17	p18	p18				p18				p19	p19													
270pF		p17	p17	p18	p18				p18				p19	p19													
330pF		p17	p17	p18	p18				p18				p19	p19													
390pF		p17	p17	p18	p18				p18				p19		p19												
470pF		p17	p17	p18	p18				p18				p19		p19												
560pF			p17	p18	p18				p18				p19		p19												
680pF			p17	p18	p18				p18				p19		p19												
820pF			p17	p18	p18				p18				p19						p19								
1000pF			p17	p18	p18	p18			p18				p19						p19								
1200pF			p17	p18	p18	p18			p18				p19								p19	p19					
1500pF			p17	p18	p18	p18			p18				p19								p19					p19	
1800pF				p18	p18	p18			p18			p18		p19							p19						
2200pF				p18	p18	p18			p18				p19								p19						
2700pF				p18	p18	p18					p18	p18		p19		p19											
3300pF				p18	p18	p18						p18	p18		p19		p19										
3900pF				p18		p18						p18	p18	p19		p19					p19						
4700pF					p18							p18	p18	p19		p19					p19						
5600pF						p18						p18	p18	p19		p19											
6800pF						p18							p19	p19				p19								p19	
8200pF						p18							p19	p19				p19									
10000pF						p18							p19	p19				p19									
12000pF						p18							p19														
15000pF						p18							p19														
18000pF									p18				p19														
22000pF									p18				p19														
27000pF													p19														
33000pF													p19														
39000pF													p19														
47000pF																											
56000pF																											



Capacitance Table p00 Each number in the Part Number List refers to the page number printed at the bottom of the page.

(→ ■ GCM Series Temperature Compensating Type)

p00 ← Part Number List EIA: C0G U2J

3.2x2.5		4.5x3.2				5.7x5.0				LxW (mm)
2.0		1.5		2.0		1.5		2.0		T max. (mm)
1000	630	1000	630	1000	630	1000	630	1000	630	Rated Voltage (Vdc)
U2J	U2J	U2J	U2J	U2J	U2J	U2J	U2J	U2J	U2J	Cap. / TC Code
										1.0pF
										2.0pF
										3.0pF
										4.0pF
										5.0pF
										6.0pF
										7.0pF
										8.0pF
										9.0pF
										10pF
										12pF
										15pF
										18pF
										22pF
										27pF
										33pF
										39pF
										47pF
										56pF
										68pF
										82pF
										100pF
										120pF
										150pF
										180pF
										220pF
										270pF
										330pF
										390pF
										470pF
										560pF
										680pF
										820pF
										1000pF
										1200pF
										1500pF
p19										1800pF
p19										2200pF
										2700pF
										3300pF
										3900pF
										4700pF
										5600pF
										6800pF
										8200pF
										10000pF
										12000pF
										15000pF
										18000pF
										22000pF
										27000pF
										33000pF
										39000pF
										47000pF
										56000pF

Capacitance Table p00 Each number in the Part Number List refers to the page number printed at the bottom of the page.

■ GCM Series High Dielectric Constant Type

p00 ← Part Number List EIA: X7R X7S

LxW (mm)	0.6x0.3			1.0x0.5				1.6x0.8					2.0x1.25							3.2x1.6								
T max. (mm)	0.33			0.55				0.9					0.7	0.95			1.4				0.95	1.25						
Rated Voltage (Vdc)	25	16	10	100	50	25	16	100	50	25	16	6.3	100	100	50	25	16	100	50	35	25	16	10	6.3	100	100		
Cap. / TC Code	X7R	X7R	X7R	X7R	X7R	X7R	X7R	X7R	X7R	X7R	X7R	X7R	X7R	X7R	X7R	X7R	X7R	X7R	X7R	X7R	X7R	X7R	X7R	X7R	X7R	X7R		
100pF	p21																											
150pF	p21																											
220pF	p21			p21	p21																							
330pF	p21			p21	p21																							
470pF	p21			p21	p21																							
680pF	p21			p21	p21																							
1000pF	p21			p21	p21			p21	p21																			
1500pF	p21			p21	p21			p21	p21																			
2200pF		p21		p21	p21			p21	p21																			
3300pF		p21		p21	p21			p21	p21																			
4700pF			p21	p21	p21			p21	p21																			
6800pF			p21		p21			p21	p21				p21															
10000pF			p21		p21	p21		p21	p21				p21															
15000pF				p21	p21			p21	p21				p21															
22000pF				p21	p21			p21	p21				p21															
33000pF					p21	p21		p21	p21					p21	p21													
47000pF					p21	p21		p21	p21									p22	p22									
68000pF						p21	p21	p21	p21									p22	p22									
0.10μF						p21	p21	p21	p21									p22	p22							p22		
0.15μF								p21	p21									p22	p22							p22		
0.22μF								p21	p21									p22	p22							p22		
0.33μF										p21						p21												
0.47μF										p21	p21						p21											
0.68μF																		p21			p22	p22						
1.0μF										p21	p21							p22		p22	p22	p22						
2.2μF												p21									p22	p22	p22					
4.7μF																						p22	p22					
10μF																							p22	p22				
22μF																								p22	p22			
47μF																												



Capacitance Table p00 Each number in the Part Number List refers to the page number printed at the bottom of the page.

(→ ■ GCM Series High Dielectric Constant Type)

p00 ← Part Number List EIA: X7R X7S

3.2x1.6								3.2x2.5								LxW (mm)	
1.25	1.3	1.8				1.9	2.2			2.7					T max. (mm)		
50	25	50	25	16	10	6.3	25	100	25	16	50	35	25	16	10	6.3	Rated Voltage (Vdc)
X7R	X7R	X7Δ	X7R	X7R	X7R	X7R	X7S	X7R	X7R	X7R	X7Δ	X7S	X7R	X7R	X7R	X7R	Cap. / TC Code
																	100pF
																	150pF
																	220pF
																	330pF
																	470pF
																	680pF
																	1000pF
																	1500pF
																	2200pF
																	3300pF
																	4700pF
																	6800pF
																	10000pF
																	15000pF
																	22000pF
																	33000pF
																	47000pF
																	68000pF
																	0.10μF
																	0.15μF
																	0.22μF
																	0.33μF
																	0.47μF
																	0.68μF
																	1.0μF
																	2.2μF
																	4.7μF
																	10μF
																	22μF
																	47μF

Capacitance Table p00 Each number in the Part Number List refers to the page number printed at the bottom of the page.

■ GCJ Series High Dielectric Constant Type

p00 ← Part Number List EIA: X7R

LxW (mm)	1.6x0.8					2.0x1.25										3.2x1.6										
	0.9					0.7			0.95				1.0		1.45				0.95		1.25			1.35		
T max. (mm)																										
Rated Voltage (Vdc)	100	50	25	16	10	100	50	25	100	50	25	16	250	250	100	50	25	16	10	100	50	1000	630	250	100	50
Cap. / TC Code	X7R	X7R	X7R	X7R	X7R	X7R	X7R	X7R	X7R	X7R	X7R	X7R	X7R	X7R	X7R	X7R	X7R	X7R	X7R	X7R	X7R	X7R	X7R	X7R	X7R	X7R
220pF													p25													
270pF													p25													
330pF								p25					p25													
390pF								p25					p25													
470pF								p25	p25				p25													
560pF								p25	p25				p25													
680pF								p25	p25				p25													
820pF								p25	p25				p25													
1000pF	p24	p24	p24					p24	p25	p25				p25									p26	p26		
1200pF	p24	p24	p24					p24	p25	p25																
1500pF	p24	p24	p24					p24	p25	p25				p25									p26	p26		
1800pF	p24	p24	p24					p24	p25	p25																
2200pF	p24	p24	p24					p24	p25	p25				p25									p26	p26		
2700pF	p24	p24	p24					p24	p25	p25																
3300pF	p24	p24	p24					p24	p25	p25				p25									p26	p26		
3900pF	p24	p24	p24					p24	p25	p25																
4700pF	p24	p24	p24					p24	p25	p25				p25									p26	p26		
5600pF	p24	p24	p24					p24	p25	p25																
6800pF	p24	p24	p24					p25	p25	p25				p25												
8200pF	p24	p24	p24					p25	p25	p25																
10000pF	p24	p24	p24	p24				p25	p25	p25				p25												
12000pF	p24	p24	p24					p25	p25	p25																
15000pF	p24	p24	p24					p25	p25					p25												
18000pF	p24	p24	p24					p25	p25																	
22000pF	p24	p24	p24					p25	p25					p25												
27000pF			p24	p24									p25	p25												
33000pF		p24	p24	p24									p25	p25												
39000pF		p24	p24	p24									p25	p25												
47000pF		p24	p24	p24																						
56000pF		p24	p24	p24																						
68000pF		p24	p24	p24																						
82000pF		p24	p24	p24																						
0.10μF		p24	p24	p24																						
0.12μF			p24	p24	p24																					
0.15μF			p24	p24	p24																					
0.18μF			p24	p24	p24																					
0.22μF			p24	p24	p24																					
0.27μF				p24																						
0.33μF				p24																						
0.39μF				p24																						
0.47μF				p24																						
0.56μF																										
0.68μF																										
0.82μF																										
1.0μF																										
1.5μF																										
2.2μF																										
3.3μF																										
4.7μF																										
6.8μF																										
10μF																										
22μF																										



Capacitance Table p00 Each number in the Part Number List refers to the page number printed at the bottom of the page.

(→ ■ GCJ Series High Dielectric Constant Type)

p00 ← Part Number List EIA: X7R

3.2x1.6										3.2x2.5							4.5x3.2					5.7x5.0			LxW (mm)		
1.35		1.8			1.9					1.5		2.0			2.3		2.8		1.5		2.0			2.0			T max. (mm)
25	16	1000	630	250	50	25	16	10	6.3	630	250	1000	630	250	100	50	25	630	250	1000	630	250	1000	630	250	Rated Voltage (Vdc)	
X7R	X7R	X7R	X7R	X7R	X7R	X7R	X7R	X7R	X7R	X7R	X7R	X7R	X7R	X7R	X7R	X7R	X7R	X7R	X7R	X7R	X7R	X7R	X7R	X7R	X7R	X7R	Cap. / TC Code
																										220pF	
																											270pF
																											330pF
																											390pF
																											470pF
																											560pF
																											680pF
																											820pF
																											1000pF
																											1200pF
																											1500pF
																											1800pF
																											2200pF
																											2700pF
																											3300pF
																											3900pF
																											4700pF
																											5600pF
																											6800pF
																											8200pF
																											10000pF
																											12000pF
																											15000pF
																											18000pF
																											22000pF
																											27000pF
																											33000pF
																											39000pF
																											47000pF
																											56000pF
																											68000pF
																											82000pF
																											0.10μF
																											0.12μF
																											0.15μF
																											0.18μF
																											0.22μF
																											0.27μF
																											0.33μF
																											0.39μF
																											0.47μF
																											0.56μF
																											0.68μF
																											0.82μF
																											1.0μF
																											1.5μF
																											2.2μF
																											3.3μF
																											4.7μF
																											6.8μF
																											10μF
																											22μF

Capacitance Table p00 Each number in the Part Number List refers to the page number printed at the bottom of the page.

■ GCD Series High Dielectric Constant Type

p00 ← Part Number List EIA: X7R

LxW (mm)	1.6x0.8			2.0x1.25				
	T max. (mm)			T max. (mm)				
Rated Voltage (Vdc)	100	50	25	100	50	100	100	50
Cap. / TC Code	X7R	X7R	X7R	X7R	X7R	X7R	X7R	X7R
1000pF	p29	p29		p29	p29			
1200pF	p29	p29		p29	p29			
1500pF	p29	p29		p29	p29			
1800pF	p29	p29		p29	p29			
2200pF	p29	p29		p29	p29			
2700pF	p29	p29		p29	p29			
3300pF	p29	p29		p29	p29			
3900pF	p29	p29		p29	p29			
4700pF	p29	p29		p29	p29			
5600pF		p29		p29	p29			
6800pF		p29				p29		
8200pF		p29					p29	
10000pF		p29					p29	
12000pF		p29					p29	
15000pF		p29						p29
18000pF		p29						p29
22000pF		p29						p29
27000pF			p29					p29
33000pF			p29					p29
39000pF			p29					p29
47000pF			p29					p29
56000pF								p29
68000pF								p29
82000pF								p29
0.10μF								p29

■ GCE Series High Dielectric Constant Type

p00 ← Part Number List EIA: X7R

LxW (mm)	1.6x0.8			2.0x1.25			
	T max. (mm)			T max. (mm)			
Rated Voltage (Vdc)	100	50	100	50	100	100	50
Cap. / TC Code	X7R	X7R	X7R	X7R	X7R	X7R	X7R
1000pF	p31	p31	p31	p31			
1200pF	p31	p31	p31	p31			
1500pF	p31	p31	p31	p31			
1800pF	p31	p31	p31	p31			
2200pF	p31	p31	p31	p31			
2700pF	p31	p31	p31	p31			
3300pF	p31	p31	p31	p31			
3900pF	p31	p31	p31	p31			
4700pF	p31	p31	p31	p31			
5600pF		p31	p31	p31			
6800pF		p31			p31		
8200pF		p31				p31	
10000pF		p31					p31
12000pF		p31					p31
15000pF		p31					p31
18000pF		p31					p31
22000pF		p31					p31
27000pF							p31
33000pF							p31
39000pF							p31
47000pF							p31
56000pF							p31
68000pF							p31
82000pF							p31
0.10μF							p31

Capacitance Table

p00 Each number in the Part Number List refers to the page number printed at the bottom of the page.

■ GCG Series

Temperature Compensating Type

High Dielectric Constant Type

p00 ← Part Number List

Murata Temperature Characteristic: X8G

EIA: X7R Murata Temperature Characteristic: X8L

LxW (mm)	2.0x1.25		
	1.6x0.8	0.7	0.95
T max. (mm)	0.9	0.7	0.95
Rated Voltage (Vdc)	50	50	50
Cap. / TC Code	X8G	X8G	X8G
10pF	p33		
12pF	p33		
15pF	p33		
18pF	p33		
22pF	p33		
27pF	p33		
33pF	p33		
39pF	p33		
47pF	p33		
56pF	p33		
68pF	p33		
82pF	p33		
100pF	p33	p33	
120pF	p33	p33	
150pF	p33	p33	
180pF	p33	p33	
220pF	p33	p33	
270pF	p33	p33	
330pF	p33	p33	
390pF	p33	p33	
470pF	p33	p33	
560pF	p33	p33	
680pF	p33	p33	
820pF	p33	p33	
1000pF	p33	p33	
1200pF	p33	p33	
1500pF	p33	p33	
1800pF	p33	p33	
2200pF	p33	p33	
2700pF	p33	p33	
3300pF	p33	p33	
3900pF	p33	p33	
4700pF	p33	p33	
5600pF	p33	p33	
6800pF	p33	p33	
8200pF	p33	p33	
10000pF	p33	p33	
0.10μF			
0.12μF			
0.15μF			
0.18μF			
0.22μF			
0.27μF			
0.33μF			
0.39μF			
0.47μF			
0.56μF			
0.68μF			
0.82μF			
1.0μF			
1.2μF			
1.5μF			
2.2μF			
3.3μF			
3.9μF			
4.7μF			
10μF			

LxW (mm)	1.0x0.5					1.6x0.8				2.0x1.25				3.2x1.6				3.2x2.5	
	0.55					0.9				1.45				1.35		1.9		2.3	2.8
T max. (mm)																			
Rated Voltage (Vdc)	50	25	16			50	25	16		50	25	16		25	16	25	16	25	25
Cap. / TC Code	X7R	X8L	X7R	X8L	X7R	X8L	X7R	X7R	X8L	X8L	X7R	X8L	X7R	X8L	X7R	X8L	X7R	X8L	X7R
220pF	p34					p34													
270pF	p34					p34													
330pF	p34					p34													
390pF	p34					p34													
470pF	p34					p34													
560pF	p34					p34													
680pF	p34					p34													
820pF	p34					p34													
1000pF	p34					p34													
1200pF	p34					p34													
1500pF	p34					p34													
1800pF	p34					p34													
2200pF	p34					p34													
2700pF	p34					p34													
3300pF	p34					p34													
3900pF	p34					p34													
4700pF	p34					p34													
5600pF		p34	p34			p34													
6800pF		p34	p34			p34													
8200pF		p34	p34			p34													
10000pF		p34	p34			p34													
12000pF						p34													
15000pF			p34	p34	p34														
18000pF			p34	p34	p34														
22000pF			p34	p34	p34														
27000pF			p34	p34		p34				p34									
33000pF			p34	p34		p34				p34									
39000pF			p34	p34		p34				p34									
47000pF			p34	p34		p34				p34									
56000pF				p34		p34													
68000pF				p34		p34				p34									
82000pF				p34		p34				p34									
0.10μF				p34						p34		p34							
0.12μF									p34										
0.15μF									p34	p34		p34							
0.18μF									p34			p34							
0.22μF									p34	p34		p34							
0.27μF														p34					
0.33μF													p34	p34	p35				
0.39μF													p34	p35					
0.47μF													p34	p35					
0.56μF													p34	p35					
0.68μF													p35	p35					
0.82μF													p35	p35					
1.0μF													p35		p35	p35			
1.2μF														p35					
1.5μF														p35	p35				
2.2μF														p35					
3.3μF																p35	p35	p35	
3.9μF																p35			
4.7μF																p35	p35		p35
10μF																			p35

Capacitance Table p00 Each number in the Part Number List refers to the page number printed at the bottom of the page.

■ GC3 Series High Dielectric Constant Type

p00 ← Part Number List EIA: X7T

LxW (mm)	2.0x1.25				3.2x1.6						3.2x2.5				4.5x3.2				5.7x5.0						
	T max. (mm)		1.0		1.0		1.25		1.8		1.5		2.0		1.5		2.0		2.0			2.7			
Rated Voltage (Vdc)	250	250	450	250	630	450	250	630	450	250	630	250	630	450	250	250	630	450	250	630	450	250	630	450	250
Cap. / TC Code	X7T	X7T	X7T	X7T	X7T	X7T	X7T	X7T	X7T	X7T	X7T	X7T	X7T	X7T	X7T	X7T	X7T	X7T	X7T	X7T	X7T	X7T	X7T	X7T	X7T
10000pF	p37		p37		p37																				
15000pF	p37		p37					p37																	
22000pF		p37					p37				p37														
33000pF			p37				p37						p37												
47000pF							p37		p37				p37												
68000pF									p37				p37				p37								
0.10µF											p37		p37							p37					
0.15µF														p37			p37			p37					
0.22µF															p37					p37		p37			
0.27µF																		p37				p37			
0.33µF																			p37		p37				
0.47µF																				p37	p37				
0.56µF																								p37	
0.68µF																						p37			
1.0µF																									p37

■ KCM Series High Dielectric Constant Type

p00 ← Part Number List EIA: X7R

LxW (mm)	6.1x5.3																	
	3.0					3.9					5.0			6.7				
Rated Voltage (Vdc)	100	63	50	35	25	100	63	50	35	25	100	35	25	100	63	50	35	25
Cap. / TC Code	X7R	X7R	X7R	X7R	X7R	X7R	X7R	X7R	X7R	X7R	X7R	X7R	X7R	X7R	X7R	X7R	X7R	X7R
4.7µF	p40	p40	p40															
6.8µF					p40													
10µF				p40			p40	p40			p40							
15µF					p40											p40		
17µF									p40									
22µF										p40	p40					p40	p40	
33µF												p40						p40
47µF																		p40

■ KC3 Series High Dielectric Constant Type

p00 ← Part Number List EIA: X7T

LxW (mm)	6.1x5.3									
	3.0			3.9			5.0		6.7	
Rated Voltage (Vdc)	630	450	250	630	450	250	450	630	450	250
Cap. / TC Code	X7T	X7T	X7T	X7T	X7T	X7T	X7T	X7T	X7T	X7T
0.10µF	p43									
0.15µF	p43									
0.22µF		p43		p43						
0.27µF				p43						
0.47µF		p43	p43					p43		
0.56µF					p43			p43		
1.0µF						p43	p43			
1.2µF									p43	
2.2µF										p43

Search Capacitors

Specifications and Test Methods, Package, Chart of Characteristic Data, please refer to the search web page.
<http://www.murata.com/products/capacitor/>

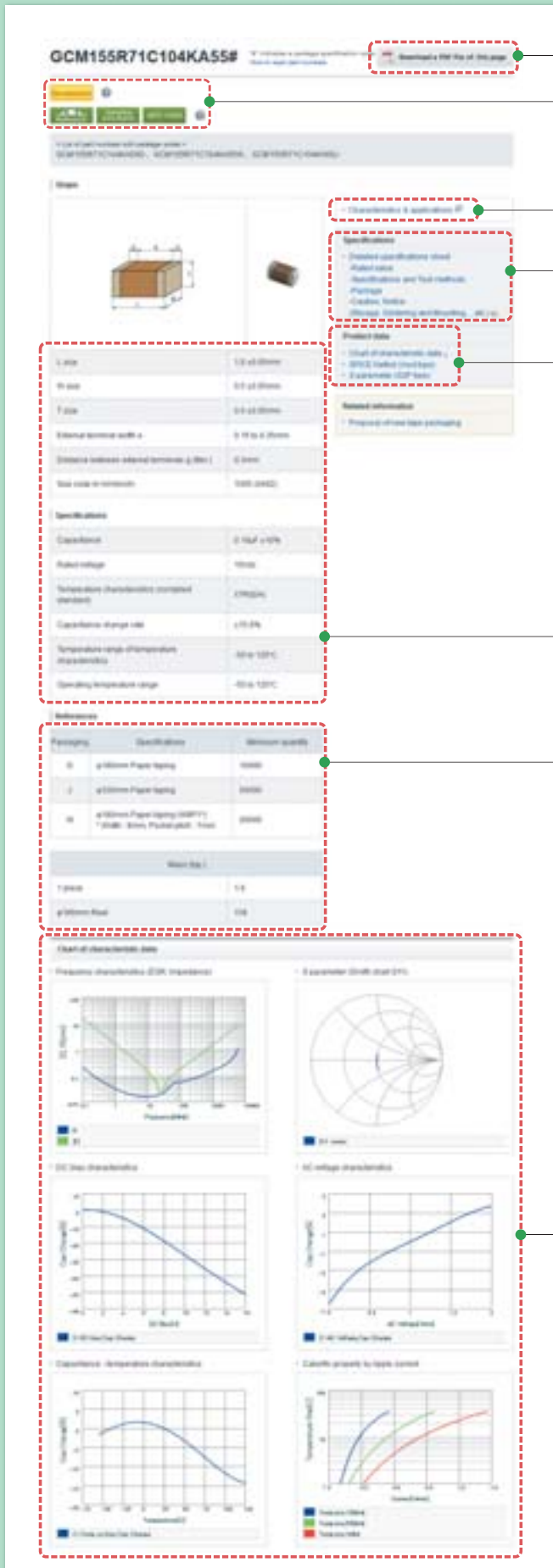

Data Sheet

The product details page can be output in PDF.

Status and Features Icons

The status and features of products can be checked at once. When ? is clicked, a description of each icon will be displayed.

Characteristics & Applications

This links to the introduction page of each series.

Detailed Specifications Sheet

- Rated value
- Specifications and Test Methods
- Package
- Caution, Notice (Storage, Soldering and Mounting,etc.)

Characteristics Data

The following characteristics data of the main products can be acquired.

- SPICE Netlist (mod type)
- S parameter (S2P type)
- Reliability Test Data *Typical data

- Shape (Dimensions)
- Rated Values

- Specification by Packaging Code/ Minimum Order Quantity
- Weight (1 pc/ø180mm reel)

Chart of Characteristic Data

The main products published characteristic data.

- Frequency characteristics (ESR, Impedance)
- S parameter (Smith chart S11)
- DC bias characteristics
- AC voltage characteristics
- Capacitance - temperature characteristics
- Calorific property by ripple current

General Purpose Product

GCM Series



Capacitor for automotive applications such as power train and safety equipment.

Features

① **Ideal for power trains and safety devices in automobiles.**

This product can be used for safety devices, such as the drive system control for engine ECU, air bags, and ABS. This product has cleared test conditions more severe than that of general products (GRM Series) even in temperature cycle and humidity load tests.

	General Purpose GRM Series Maximum operating temperature: 85°C/105°C/125°C	GCM Series for Automobiles Maximum operating temperature: 125°C
Items	Test Method	Test Method
Temperature Cycle	Temperature Cycle: 5 cycles	Temperature Cycle: 100 cycles (1,000 cycles for AEC-Q200 conforming products)
Humidity Loading	Test temperature: 40±2°C Test humidity: 90 to 95%RH Test time: 500 hours	Test temperature: 85±2°C Test humidity: 80 to 85%RH Test time: 500 hours (1,000 hours for AEC-Q200 conforming products)

② **Can be used at 125°C and 150°C temperatures.**

We also offer a lineup for 150°C that can be used in the engine room.

③ **Sn plating is applied to the external electrodes; excellent solder ability.**

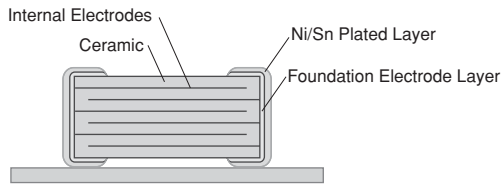

<Example of Structure>

Specifications

Size	0.6×0.3mm to 5.7×5.0mm
Rated Voltage	DC6.3 to 1kV
Capacitance	0.1pF to 47μF
Main Applications	Drive system control of engine ECU, Airbag, Safety equipment such as ABS

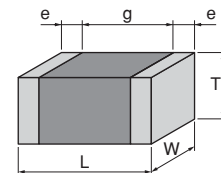

<Dimensions>

GCM Series Temperature Compensating Type AEC-Q200 Part Number List

■ 0.6×0.3mm Ultra-compact

T max.	Rated Voltage	TC Code	Cap.	Tol.	Part Number
0.33mm	25Vdc	COG	1.0pF	±0.25pF	GCM0335C1E1R0CD03#
			2.0pF	±0.25pF	GCM0335C1E2R0CD03#
			3.0pF	±0.25pF	GCM0335C1E3R0CD03#
			4.0pF	±0.25pF	GCM0335C1E4R0CD03#
			5.0pF	±0.25pF	GCM0335C1E5R0CD03#
			6.0pF	±0.5pF	GCM0335C1E6R0DD03#
			7.0pF	±0.5pF	GCM0335C1E7R0DD03#
			8.0pF	±0.5pF	GCM0335C1E8R0DD03#
			9.0pF	±0.5pF	GCM0335C1E9R0DD03#
			10pF	±5%	GCM0335C1E100JD03#
			12pF	±5%	GCM0335C1E120JD03#
			15pF	±5%	GCM0335C1E150JD03#
			18pF	±5%	GCM0335C1E180JD03#
			22pF	±5%	GCM0335C1E220JD03#
			27pF	±5%	GCM0335C1E270JD03#
			33pF	±5%	GCM0335C1E330JD03#
			39pF	±5%	GCM0335C1E390JD03#
			47pF	±5%	GCM0335C1E470JD03#
			56pF	±5%	GCM0335C1E560JD03#
			68pF	±5%	GCM0335C1E680JD03#
82pF	±5%	GCM0335C1E820JD03#			
100pF	±5%	GCM0335C1E101JD03#			

■ 1.0×0.5mm

T max.	Rated Voltage	TC Code	Cap.	Tol.	Part Number
0.55mm	50Vdc	COG	1.0pF	±0.25pF	GCM1555C1H1R0CA16#
			2.0pF	±0.25pF	GCM1555C1H2R0CA16#
			3.0pF	±0.25pF	GCM1555C1H3R0CA16#
			4.0pF	±0.25pF	GCM1555C1H4R0CA16#
			5.0pF	±0.25pF	GCM1555C1H5R0CA16#
			6.0pF	±0.5pF	GCM1555C1H6R0DA16#
			7.0pF	±0.5pF	GCM1555C1H7R0DA16#
			8.0pF	±0.5pF	GCM1555C1H8R0DA16#
			9.0pF	±0.5pF	GCM1555C1H9R0DA16#
			10pF	±5%	GCM1555C1H100JA16#
			12pF	±5%	GCM1555C1H120JA16#
			15pF	±5%	GCM1555C1H150JA16#
			18pF	±5%	GCM1555C1H180JA16#
			22pF	±5%	GCM1555C1H220JA16#
			27pF	±5%	GCM1555C1H270JA16#
			33pF	±5%	GCM1555C1H330JA16#
			39pF	±5%	GCM1555C1H390JA16#
			47pF	±5%	GCM1555C1H470JA16#
			56pF	±5%	GCM1555C1H560JA16#
			68pF	±5%	GCM1555C1H680JA16#
82pF	±5%	GCM1555C1H820JA16#			
100pF	±5%	GCM1555C1H101JA16#			
120pF	±5%	GCM1555C1H121JA16#			
150pF	±5%	GCM1555C1H151JA16#			
180pF	±5%	GCM1555C1H181JA16#			

T max.	Rated Voltage	TC Code	Cap.	Tol.	Part Number
0.55mm	50Vdc	COG	220pF	±5%	GCM1555C1H221JA16#
			270pF	±5%	GCM1555C1H271JA16#
			330pF	±5%	GCM1555C1H331JA16#
			390pF	±5%	GCM1555C1H391JA16#
			470pF	±5%	GCM1555C1H471JA16#

■ 1.6×0.8mm

T max.	Rated Voltage	TC Code	Cap.	Tol.	Part Number
0.9mm	100Vdc	COG	1.0pF	±0.25pF	GCM1885C2A1R0CA16#
			2.0pF	±0.25pF	GCM1885C2A2R0CA16#
			3.0pF	±0.25pF	GCM1885C2A3R0CA16#
			4.0pF	±0.25pF	GCM1885C2A4R0CA16#
			5.0pF	±0.25pF	GCM1885C2A5R0CA16#
			6.0pF	±0.5pF	GCM1885C2A6R0DA16#
			7.0pF	±0.5pF	GCM1885C2A7R0DA16#
			8.0pF	±0.5pF	GCM1885C2A8R0DA16#
			9.0pF	±0.5pF	GCM1885C2A9R0DA16#
			10pF	±5%	GCM1885C2A100JA16#
			12pF	±5%	GCM1885C2A120JA16#
			15pF	±5%	GCM1885C2A150JA16#
			18pF	±5%	GCM1885C2A180JA16#
			22pF	±5%	GCM1885C2A220JA16#
			27pF	±5%	GCM1885C2A270JA16#
			33pF	±5%	GCM1885C2A330JA16#
			39pF	±5%	GCM1885C2A390JA16#
			47pF	±5%	GCM1885C2A470JA16#
			56pF	±5%	GCM1885C2A560JA16#
			68pF	±5%	GCM1885C2A680JA16#
			82pF	±5%	GCM1885C2A820JA16#
			100pF	±5%	GCM1885C2A101JA16#
			120pF	±5%	GCM1885C2A121JA16#
			150pF	±5%	GCM1885C2A151JA16#
			180pF	±5%	GCM1885C2A181JA16#
			220pF	±5%	GCM1885C2A221JA16#
			270pF	±5%	GCM1885C2A271JA16#
			330pF	±5%	GCM1885C2A331JA16#
			390pF	±5%	GCM1885C2A391JA16#
			470pF	±5%	GCM1885C2A471JA16#
560pF	±5%	GCM1885C2A561JA16#			
680pF	±5%	GCM1885C2A681JA16#			
820pF	±5%	GCM1885C2A821JA16#			
1000pF	±5%	GCM1885C2A102JA16#			
1200pF	±5%	GCM1885C2A122JA16#			
1500pF	±5%	GCM1885C2A152JA16#			
	50Vdc	COG	1.0pF	±0.25pF	GCM1885C1H1R0CA16#
			2.0pF	±0.25pF	GCM1885C1H2R0CA16#
			3.0pF	±0.25pF	GCM1885C1H3R0CA16#
			4.0pF	±0.25pF	GCM1885C1H4R0CA16#
			5.0pF	±0.25pF	GCM1885C1H5R0CA16#
			6.0pF	±0.5pF	GCM1885C1H6R0DA16#
			7.0pF	±0.5pF	GCM1885C1H7R0DA16#
			8.0pF	±0.5pF	GCM1885C1H8R0DA16#

Part number # indicates the package specification code.

GCM Series Temperature Compensating Type AEC-Q200 Part Number List

(→ ■ 1.6x0.8mm)

T max.	Rated Voltage	TC Code	Cap.	Tol.	Part Number
0.9mm	50Vdc	C0G	9.0pF	±0.5pF	GCM1885C1H9R0DA16#
			10pF	±5%	GCM1885C1H100JA16#
			12pF	±5%	GCM1885C1H120JA16#
			15pF	±5%	GCM1885C1H150JA16#
			18pF	±5%	GCM1885C1H180JA16#
			22pF	±5%	GCM1885C1H220JA16#
			27pF	±5%	GCM1885C1H270JA16#
			33pF	±5%	GCM1885C1H330JA16#
			39pF	±5%	GCM1885C1H390JA16#
			47pF	±5%	GCM1885C1H470JA16#
			56pF	±5%	GCM1885C1H560JA16#
			68pF	±5%	GCM1885C1H680JA16#
			82pF	±5%	GCM1885C1H820JA16#
			100pF	±5%	GCM1885C1H101JA16#
			120pF	±5%	GCM1885C1H121JA16#
			150pF	±5%	GCM1885C1H151JA16#
			180pF	±5%	GCM1885C1H181JA16#
			220pF	±5%	GCM1885C1H221JA16#
			270pF	±5%	GCM1885C1H271JA16#
			330pF	±5%	GCM1885C1H331JA16#
			390pF	±5%	GCM1885C1H391JA16#
			470pF	±5%	GCM1885C1H471JA16#
			560pF	±5%	GCM1885C1H561JA16#
			680pF	±5%	GCM1885C1H681JA16#
			820pF	±5%	GCM1885C1H821JA16#
			1000pF	±5%	GCM1885C1H102JA16#
			1200pF	±5%	GCM1885C1H122JA16#
			1500pF	±5%	GCM1885C1H152JA16#
			1800pF	±5%	GCM1885C1H182JA16#
			2200pF	±5%	GCM1885C1H222JA16#
2700pF	±5%	GCM1885C1H272JA16#			
3300pF	±5%	GCM1885C1H332JA16#			
3900pF	±5%	GCM1885C1H392JA16#			

■ 2.0x1.25mm

T max.	Rated Voltage	TC Code	Cap.	Tol.	Part Number
0.7mm	100Vdc	C0G	100pF	±5%	GCM2165C2A101JA16#
			120pF	±5%	GCM2165C2A121JA16#
			150pF	±5%	GCM2165C2A151JA16#
			180pF	±5%	GCM2165C2A181JA16#
			220pF	±5%	GCM2165C2A221JA16#
			270pF	±5%	GCM2165C2A271JA16#
			330pF	±5%	GCM2165C2A331JA16#
			390pF	±5%	GCM2165C2A391JA16#
			470pF	±5%	GCM2165C2A471JA16#
			560pF	±5%	GCM2165C2A561JA16#
			680pF	±5%	GCM2165C2A681JA16#
			820pF	±5%	GCM2165C2A821JA16#
			1000pF	±5%	GCM2165C2A102JA16#
			1200pF	±5%	GCM2165C2A122JA16#
			1500pF	±5%	GCM2165C2A152JA16#
			1800pF	±5%	GCM2165C2A182JA16#

T max.	Rated Voltage	TC Code	Cap.	Tol.	Part Number			
0.7mm	100Vdc	C0G	2200pF	±5%	GCM2165C2A222JA16#			
			2700pF	±5%	GCM2165C2A272JA16#			
			3300pF	±5%	GCM2165C2A332JA16#			
			1000pF	±5%	GCM2165C1H102JA16#			
			1200pF	±5%	GCM2165C1H122JA16#			
			1500pF	±5%	GCM2165C1H152JA16#			
	50Vdc	C0G	1800pF	±5%	GCM2165C1H182JA16#			
			2200pF	±5%	GCM2165C1H222JA16#			
			2700pF	±5%	GCM2165C1H272JA16#			
			3300pF	±5%	GCM2165C1H332JA16#			
			3900pF	±5%	GCM2165C1H392JA16#			
			4700pF	±5%	GCM2165C1H472JA16#			
0.95mm	50Vdc	C0G	5600pF	±5%	GCM2195C1H562JA16#			
			6800pF	±5%	GCM2195C1H682JA16#			
			8200pF	±5%	GCM2195C1H822JA16#			
			10000pF	±5%	GCM2195C1H103JA16#			
			12000pF	±5%	GCM2195C1H123JA16#			
			15000pF	±5%	GCM2195C1H153JA16#			
			1.0mm	250Vdc	U2J	100pF	±5%	GCM21A7U2E101JX01D
						120pF	±5%	GCM21A7U2E121JX01D
						150pF	±5%	GCM21A7U2E151JX01D
						180pF	±5%	GCM21A7U2E181JX01D
						220pF	±5%	GCM21A7U2E221JX01D
						270pF	±5%	GCM21A7U2E271JX01D
330pF	±5%	GCM21A7U2E331JX01D						
390pF	±5%	GCM21A7U2E391JX01D						
470pF	±5%	GCM21A7U2E471JX01D						
560pF	±5%	GCM21A7U2E561JX01D						
680pF	±5%	GCM21A7U2E681JX01D						
820pF	±5%	GCM21A7U2E821JX01D						
1.4mm	50Vdc	C0G	18000pF	±5%	GCM21B5C1H183JA16#			
			22000pF	±5%	GCM21B5C1H223JA16#			
			1.45mm	250Vdc	U2J	2700pF	±5%	GCM21B7U2E272JX03L
						3300pF	±5%	GCM21B7U2E332JX03L
3900pF	±5%	GCM21B7U2E392JX03L						
4700pF	±5%	GCM21B7U2E472JX03L						
1.45mm	250Vdc	U2J	5600pF	±5%	GCM21B7U2E562JX03L			

■ 3.2x1.6mm

T max.	Rated Voltage	TC Code	Cap.	Tol.	Part Number
0.95mm	100Vdc	C0G	1800pF	±5%	GCM3195C2A182JA16#
			2200pF	±5%	GCM3195C2A222JA16#
			2700pF	±5%	GCM3195C2A272JA16#
			3300pF	±5%	GCM3195C2A332JA16#
			3900pF	±5%	GCM3195C2A392JA16#
			4700pF	±5%	GCM3195C2A472JA16#
			5600pF	±5%	GCM3195C2A562JA16#

Part number # indicates the package specification code.

GCM Series
 GCJ Series
 GCD Series
 GCE Series
 GCG Series
 GC3 Series
 KCM Series
 KC3 Series
 ⚠Caution/Notice

GCM Series Temperature Compensating Type AEC-Q200 Part Number List

(→ ■ 3.2x1.6mm)

T max.	Rated Voltage	TC Code	Cap.	Tol.	Part Number		
0.95mm	100Vdc	C0G	6800pF	±5%	GCM3195C2A682JA16#		
			8200pF	±5%	GCM3195C2A822JA16#		
			10000pF	±5%	GCM3195C2A103JA16#		
		50Vdc	C0G	3900pF	±5%	GCM3195C1H392JA16#	
				4700pF	±5%	GCM3195C1H472JA16#	
				5600pF	±5%	GCM3195C1H562JA16#	
	6800pF			±5%	GCM3195C1H682JA16#		
	8200pF			±5%	GCM3195C1H822JA16#		
	10000pF			±5%	GCM3195C1H103JA16#		
	12000pF			±5%	GCM3195C1H123JA16#		
	15000pF			±5%	GCM3195C1H153JA16#		
	18000pF			±5%	GCM3195C1H183JA16#		
	22000pF			±5%	GCM3195C1H223JA16#		
	27000pF			±5%	GCM3195C1H273JA16#		
	33000pF			±5%	GCM3195C1H333JA16#		
	39000pF			±5%	GCM3195C1H393JA16#		
	1.0mm			1000Vdc	U2J	10pF	±5%
		12pF	±5%			GCM31A7U3A120JX01D	
		15pF	±5%			GCM31A7U3A150JX01D	
		18pF	±5%			GCM31A7U3A180JX01D	
22pF		±5%	GCM31A7U3A220JX01D				
27pF		±5%	GCM31A7U3A270JX01D				
33pF		±5%	GCM31A7U3A330JX01D				
39pF		±5%	GCM31A7U3A390JX01D				
47pF		±5%	GCM31A7U3A470JX01D				
56pF		±5%	GCM31A7U3A560JX01D				
68pF		±5%	GCM31A7U3A680JX01D				
82pF		±5%	GCM31A7U3A820JX01D				
100pF		±5%	GCM31A7U3A101JX01D				
120pF		±5%	GCM31A7U3A121JX01D				
150pF		±5%	GCM31A7U3A151JX01D				
180pF		±5%	GCM31A7U3A181JX01D				
220pF		±5%	GCM31A7U3A221JX01D				
270pF		±5%	GCM31A7U3A271JX01D				
330pF		±5%	GCM31A7U3A331JX01D				
630Vdc		U2J	10pF			±5%	GCM31A7U2J100JX01D
			12pF			±5%	GCM31A7U2J120JX01D
			15pF			±5%	GCM31A7U2J150JX01D
			18pF			±5%	GCM31A7U2J180JX01D
			22pF			±5%	GCM31A7U2J220JX01D
			27pF	±5%	GCM31A7U2J270JX01D		
630Vdc		U2J	27pF	±5%	GCM31A7U2J270JX01D		
			33pF	±5%	GCM31A7U2J330JX01D		
			39pF	±5%	GCM31A7U2J390JX01D		
			47pF	±5%	GCM31A7U2J470JX01D		
			56pF	±5%	GCM31A7U2J560JX01D		
	68pF		±5%	GCM31A7U2J680JX01D			
	82pF		±5%	GCM31A7U2J820JX01D			
	100pF		±5%	GCM31A7U2J101JX01D			
	120pF		±5%	GCM31A7U2J121JX01D			
	150pF		±5%	GCM31A7U2J151JX01D			
	180pF		±5%	GCM31A7U2J181JX01D			
	220pF		±5%	GCM31A7U2J221JX01D			
	270pF		±5%	GCM31A7U2J271JX01D			
	330pF		±5%	GCM31A7U2J331JX01D			

T max.	Rated Voltage	TC Code	Cap.	Tol.	Part Number		
1.0mm	630Vdc	U2J	390pF	±5%	GCM31A7U2J391JX01D		
			470pF	±5%	GCM31A7U2J471JX01D		
			560pF	±5%	GCM31A7U2J561JX01D		
			680pF	±5%	GCM31A7U2J681JX01D		
			820pF	±5%	GCM31A7U2J821JX01D		
			1000pF	±5%	GCM31A7U2J102JX01D		
			1200pF	±5%	GCM31A7U2J122JX01D		
			1500pF	±5%	GCM31A7U2J152JX01D		
			1800pF	±5%	GCM31A7U2J182JX01D		
			2200pF	±5%	GCM31A7U2J222JX01D		
			250Vdc	U2J	2700pF	±5%	GCM31A7U2E272JX01D
					3300pF	±5%	GCM31A7U2E332JX01D
	3900pF	±5%			GCM31A7U2E392JX01D		
	4700pF	±5%			GCM31A7U2E472JX01D		
	5600pF	±5%			GCM31A7U2E562JX01D		
	6300pF	±5%			GCM31A7U2E632JX01D		
	1.25mm	1000Vdc	U2J	390pF	±5%	GCM31B7U3A391JX01L	
				470pF	±5%	GCM31B7U3A471JX01L	
560pF				±5%	GCM31B7U3A561JX01L		
680pF				±5%	GCM31B7U3A681JX01L		
630Vdc				U2J	2700pF	±5%	GCM31B7U2J272JX01L
					3300pF	±5%	GCM31B7U2J332JX01L
		250Vdc	U2J		6800pF	±5%	GCM31B7U2E682JX01L
					8200pF	±5%	GCM31B7U2E822JX01L
					10000pF	±5%	GCM31B7U2E103JX01L
					50Vdc	C0G	47000pF
56000pF				±5%			GCM31M5C1H563JA16#
1.8mm				1000Vdc	U2J	820pF	±5%
	1000pF	±5%	GCM31C7U3A102JX03L				
	630Vdc	U2J	3900pF			±5%	GCM31C7U2J392JX03L
			4700pF	±5%	GCM31C7U2J472JX03L		

■ 3.2x2.5mm

T max.	Rated Voltage	TC Code	Cap.	Tol.	Part Number
1.0mm	630Vdc	U2J	1200pF	±5%	GCM32A7U2J122JX01D
			1500pF	±5%	GCM32A7U2J152JX01D
			1800pF	±5%	GCM32A7U2J182JX01D
			2200pF	±5%	GCM32A7U2J222JX01D
1.25mm	1000Vdc	U2J	1200pF	±5%	GCM32B7U3A122JX01L
	630Vdc	U2J	5600pF	±5%	GCM32B7U2J562JX01L
1.5mm	1000Vdc	U2J	1500pF	±5%	GCM32Q7U3A152JX01L
	630Vdc	U2J	6800pF	±5%	GCM32Q7U2J682JX01L
2.0mm	1000Vdc	U2J	1800pF	±5%	GCM32D7U3A182JX01L
			2200pF	±5%	GCM32D7U3A222JX01L
	630Vdc	U2J	8200pF	±5%	GCM32D7U2J822JX01L
			10000pF	±5%	GCM32D7U2J103JX01L

■ 4.5x3.2mm

T max.	Rated Voltage	TC Code	Cap.	Tol.	Part Number
1.5mm	1000Vdc	U2J	2700pF	±5%	GCM43Q7U3A272JX01L
			3300pF	±5%	GCM43Q7U3A332JX01L

Part number # indicates the package specification code.

GCM Series Temperature Compensating Type AEC-Q200 Part Number List

(→ ■ 4.5×3.2mm)

T max.	Rated Voltage	TC Code	Cap.	Tol.	Part Number
1.5mm	630Vdc	U2J	12000pF	±5%	GCM43Q7U2J123JX01L
2.0mm	1000Vdc	U2J	3900pF	±5%	GCM43D7U3A392JX01L
			4700pF	±5%	GCM43D7U3A472JX01L
	630Vdc	U2J	15000pF	±5%	GCM43D7U2J153JX01L
			18000pF	±5%	GCM43D7U2J183JX01L
			22000pF	±5%	GCM43D7U2J223JX01L

■ 5.7×5.0mm

T max.	Rated Voltage	TC Code	Cap.	Tol.	Part Number
1.5mm	1000Vdc	U2J	5600pF	±5%	GCM55Q7U3A562JX01L
			6800pF	±5%	GCM55Q7U3A682JX01L
	630Vdc	U2J	27000pF	±5%	GCM55Q7U2J273JX01L
2.0mm	1000Vdc	U2J	8200pF	±5%	GCM55D7U3A822JX01L
			10000pF	±5%	GCM55D7U3A103JX01L
	630Vdc	U2J	33000pF	±5%	GCM55D7U2J333JX01L
			39000pF	±5%	GCM55D7U2J393JX01L
			47000pF	±5%	GCM55D7U2J473JX01L

GCM Series

GCU Series

GCD Series

GCE Series

GCG Series

GC3 Series

KCM Series

KC3 Series

⚠Caution/Notice

Part number # indicates the package specification code.

GCM Series High Dielectric Constant Type AEC-Q200 Part Number List

■ 0.6×0.3mm Ultra-compact

T max.	Rated Voltage	TC Code	Cap.	Tol.	Part Number
0.33mm	25Vdc	X7R	100pF	±10%	GCM033R71E101KA03#
			150pF	±10%	GCM033R71E151KA03#
			220pF	±10%	GCM033R71E221KA03#
			330pF	±10%	GCM033R71E331KA03#
			470pF	±10%	GCM033R71E471KA03#
			680pF	±10%	GCM033R71E681KA03#
			1000pF	±10%	GCM033R71E102KA03#
			1500pF	±10%	GCM033R71E152KA03#
	16Vdc	X7R	2200pF	±10%	GCM033R71C222KA55#
			3300pF	±10%	GCM033R71C332KA55#
	10Vdc	X7R	4700pF	±10%	GCM033R71A472KA03#
			6800pF	±10%	GCM033R71A682KA03#
			10000pF	±10%	GCM033R71A103KA03#

■ 1.0×0.5mm

T max.	Rated Voltage	TC Code	Cap.	Tol.	Part Number		
0.55mm	100Vdc	X7R	220pF	±10%	GCM155R72A221KA37#		
			330pF	±10%	GCM155R72A331KA37#		
			470pF	±10%	GCM155R72A471KA37#		
			680pF	±10%	GCM155R72A681KA37#		
			1000pF	±10%	GCM155R72A102KA37#		
			1500pF	±10%	GCM155R72A152KA37#		
			2200pF	±10%	GCM155R72A222KA37#		
			3300pF	±10%	GCM155R72A332KA37#		
			4700pF	±10%	GCM155R72A472KA37#		
			50Vdc	X7R	220pF	±10%	GCM155R71H221KA37#
					330pF	±10%	GCM155R71H331KA37#
					470pF	±10%	GCM155R71H471KA37#
					680pF	±10%	GCM155R71H681KA37#
					1000pF	±10%	GCM155R71H102KA37#
					1500pF	±10%	GCM155R71H152KA37#
	2200pF	±10%			GCM155R71H222KA37#		
	3300pF	±10%			GCM155R71H332KA37#		
	4700pF	±10%			GCM155R71H472KA37#		
	X7R	6800pF		±10%	GCM155R71H682KA55#		
		10000pF		±10%	GCM155R71H103KA55#		
		15000pF		±10%	GCM155R71H153KA55#		
		22000pF		±10%	GCM155R71H223KA55#		
		25Vdc		X7R	10000pF	±10%	GCM155R71E103KA37#
					15000pF	±10%	GCM155R71E153KA55#
					22000pF	±10%	GCM155R71E223KA55#
					33000pF	±10%	GCM155R71E333KA55#
					47000pF	±10%	GCM155R71E473KA55#
	68000pF		±10%		GCM155R71E683KA55#		
	16Vdc	X7R	33000pF	±10%	GCM155R71C333KA37#		
			47000pF	±10%	GCM155R71C473KA37#		
			68000pF	±10%	GCM155R71C683KA55#		
			0.10μF	±10%	GCM155R71C104KA55#		

■ 1.6×0.8mm

T max.	Rated Voltage	TC Code	Cap.	Tol.	Part Number		
0.9mm	100Vdc	X7R	1000pF	±10%	GCM188R72A102KA37#		
			1500pF	±10%	GCM188R72A152KA37#		
			2200pF	±10%	GCM188R72A222KA37#		
			3300pF	±10%	GCM188R72A332KA37#		
			4700pF	±10%	GCM188R72A472KA37#		
			6800pF	±10%	GCM188R72A682KA37#		
			10000pF	±10%	GCM188R72A103KA37#		
			15000pF	±10%	GCM188R72A153KA37#		
			22000pF	±10%	GCM188R72A223KA37#		
			0.10μF	±10%	GCM188R72A104KA64#		
			50Vdc	X7R	1000pF	±10%	GCM188R71H102KA37#
					1500pF	±10%	GCM188R71H152KA37#
					2200pF	±10%	GCM188R71H222KA37#
					3300pF	±10%	GCM188R71H332KA37#
					4700pF	±10%	GCM188R71H472KA37#
	6800pF	±10%			GCM188R71H682KA37#		
	10000pF	±10%			GCM188R71H103KA37#		
	15000pF	±10%			GCM188R71H153KA37#		
	22000pF	±10%			GCM188R71H223KA37#		
	33000pF	±10%			GCM188R71H333KA55#		
	47000pF	±10%			GCM188R71H473KA55#		
	68000pF	±10%			GCM188R71H683KA57#		
	0.10μF	±10%			GCM188R71H104KA57#		
	0.15μF	±10%			GCM188R71H154KA64#		
	0.22μF	±10%			GCM188R71H224KA64#		
	25Vdc	X7R	33000pF	±10%	GCM188R71E333KA37#		
			47000pF	±10%	GCM188R71E473KA37#		
			68000pF	±10%	GCM188R71E683KA57#		
			0.10μF	±10%	GCM188R71E104KA57#		
			0.15μF	±10%	GCM188R71E154KA37#		
0.22μF			±10%	GCM188R71E224KA55#			
0.47μF			±10%	GCM188R71E474KA64#			
1.0μF			±10%	GCM188R71E105KA64#			
16Vdc			X7R	0.10μF	±10%	GCM188R71C104KA37#	
	0.33μF	±10%		GCM188R71C334KA37#			
	0.47μF	±10%		GCM188R71C474KA55#			
	1.0μF	±10%		GCM188R71C105KA64#			
	6.3Vdc	X7R		2.2μF	±10%	GCM188R70J225KE22#	

■ 2.0×1.25mm

T max.	Rated Voltage	TC Code	Cap.	Tol.	Part Number
0.7mm	100Vdc	X7R	6800pF	±10%	GCM216R72A682KA37#
			10000pF	±10%	GCM216R72A103KA37#
			15000pF	±10%	GCM216R72A153KA37#
			22000pF	±10%	GCM216R72A223KA37#
0.95mm	100Vdc	X7R	33000pF	±10%	GCM219R72A333KA37#
			50Vdc	X7R	33000pF
	0.33μF	±10%	GCM219R71H334KA55#		
	25Vdc	X7R	0.47μF	±10%	GCM219R71E474KA55#
			16Vdc	X7R	0.68μF

Part number # indicates the package specification code.

GCM Series High Dielectric Constant Type AEC-Q200 Part Number List

(→ ■ 2.0x1.25mm)

T max.	Rated Voltage	TC Code	Cap.	Tol.	Part Number		
0.95mm	16Vdc	X7R	1.0μF	±10%	GCM219R71C105KA37#		
1.4mm	100Vdc	X7R	47000pF	±10%	GCM21BR72A473KA37#		
			68000pF	±10%	GCM21BR72A683KA37#		
			0.10μF	±10%	GCM21BR72A104KA37#		
	50Vdc	X7R	47000pF	±10%	GCM21BR71H473KA37#		
			68000pF	±10%	GCM21BR71H683KA37#		
			0.10μF	±10%	GCM21BR71H104KA37#		
			0.15μF	±10%	GCM21BR71H154KA37#		
			0.22μF	±10%	GCM21BR71H224KA37#		
			0.47μF	±10%	GCM21BR71H474KA55#		
			1.0μF	±10%	GCM21BR71H105KA03#		
			35Vdc	X7R	0.68μF	±10%	GCM21BR7YA684KA55#
					1.0μF	±10%	GCM21BR7YA105KA55#
	25Vdc	X7R	0.15μF	±10%	GCM21BR71E154KA37#		
			0.22μF	±10%	GCM21BR71E224KA37#		
			0.33μF	±10%	GCM21BR71E334KA37#		
			0.68μF	±10%	GCM21BR71E684KA55#		
			1.0μF	±10%	GCM21BR71E105KA56#		
			2.2μF	±10%	GCM21BR71E225KA73#		
16Vdc	X7R	2.2μF	±10%	GCM21BR71C225KA64#			
		4.7μF	±10%	GCM21BR71C475KA73#			
10Vdc	X7R	2.2μF	±10%	GCM21BR71A225KA37#			
		10μF	±10%	GCM21BR71A106KE22#			
	X7S	4.7μF	±10%	GCM21BC71A475KA73#			
6.3Vdc	X7R	10μF	±10%	GCM21BR70J106KE22#			

T max.	Rated Voltage	TC Code	Cap.	Tol.	Part Number
2.7mm	50Vdc	X7R	1.0μF	±10%	GCM32ER71H105KA37#
			4.7μF	±10%	GCM32ER71H475KA55#
		X7S	10μF	±10%	GCM32EC71H106KA03#
	35Vdc	X7S	10μF	±10%	GCM32EC7YA106KA03#
	25Vdc	X7R	10μF	±10%	GCM32ER71E106KA57#
	16Vdc	X7R	22μF	±20%	GCM32ER71C226ME19#
	10Vdc	X7R	22μF	±20%	GCM32ER71A226ME12#
	6.3Vdc	X7R	47μF	±20%	GCM32ER70J476ME19#

■ 3.2x1.6mm

T max.	Rated Voltage	TC Code	Cap.	Tol.	Part Number
0.95mm	100Vdc	X7R	0.10μF	±10%	GCM319R72A104KA37#
1.25mm	100Vdc	X7R	0.15μF	±10%	GCM31MR72A154KA37#
			0.22μF	±10%	GCM31MR72A224KA37#
	50Vdc	X7R	0.33μF	±10%	GCM31MR71H334KA37#
			0.47μF	±10%	GCM31MR71H474KA37#
			0.68μF	±10%	GCM31MR71H684KA55#
			1.0μF	±10%	GCM31MR71H105KA55#
1.3mm	25Vdc	X7R	2.2μF	±10%	GCM31MR71E225KA57#
1.8mm	50Vdc	X7R	2.2μF	±10%	GCM31CR71H225KA55#
		X7S	4.7μF	±10%	GCM31CC71H475KA03#
	25Vdc	X7R	4.7μF	±10%	GCM31CR71E475KA55#
		X7R	4.7μF	±10%	GCM31CR71C475KA37#
	16Vdc	X7R	4.7μF	±10%	GCM31CR71C106KA64#
			10μF	±10%	GCM31CR71A106KA64#
10Vdc	X7R	10μF	±10%	GCM31CR71A106KA64#	
6.3Vdc	X7R	22μF	±20%	GCM31CR70J226ME23#	
1.9mm	25Vdc	X7S	10μF	±10%	GCM31CC71E106KA03#

■ 3.2x2.5mm

T max.	Rated Voltage	TC Code	Cap.	Tol.	Part Number
2.2mm	100Vdc	X7R	2.2μF	±10%	GCM32DR72A225KA64#
	25Vdc	X7R	4.7μF	±10%	GCM32DR71E475KA55#
	16Vdc	X7R	10μF	±10%	GCM32DR71C106KA37#

Part number # indicates the package specification code.

GCM Series
 GCJ Series
 GCD Series
 GCE Series
 GCG Series
 GC3 Series
 KCM Series
 KC3 Series
 ⚠Caution/Notice

Resin External Electrode Product

GCJ Series



AEC-Q200

Fail safe

Deflecting crack

The resin external electrodes prevent the occurrence of cracking caused by deflection stress after board mounting!

Features

① The resin external electrodes suppress cracks by board deflection.

Cracking of the ceramic element is suppressed by the resin of the external electrodes, which releases the stress.

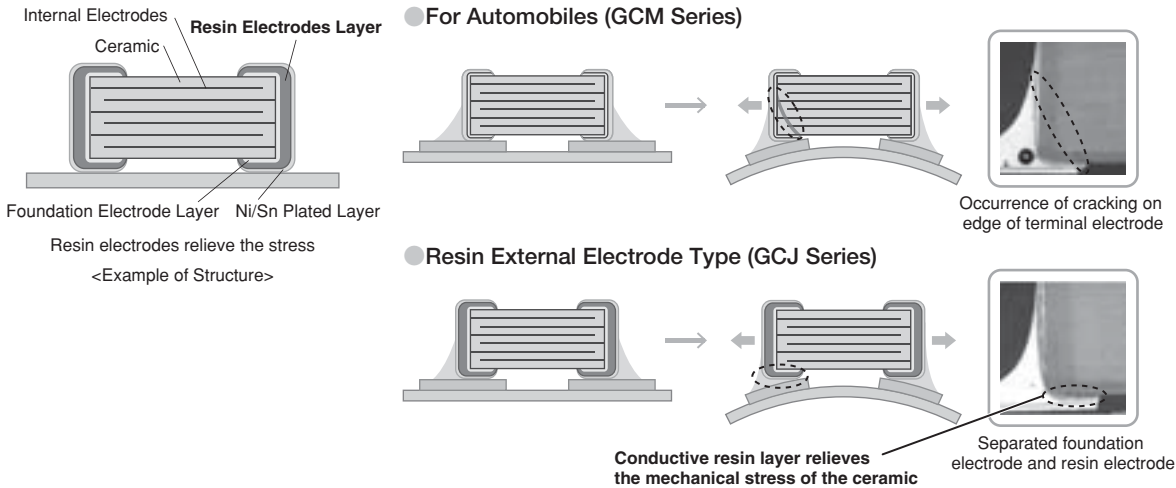

② Suppresses the occurrence of cracking caused by deflection stress at the time of board mounting, etc.

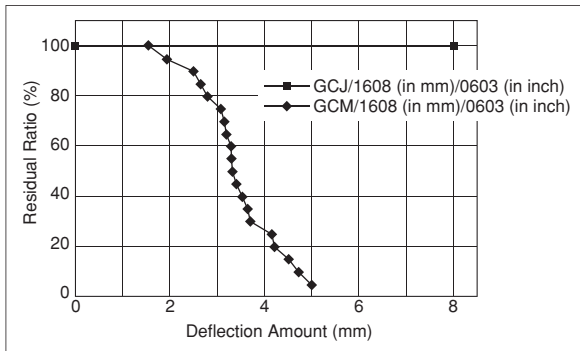

Due to the specification of the measuring instrument, measurements can be performed up to 8mm.

③ Ideal for automobiles.

This AEC-Q200 conforming product is ideal for the ECU, control circuits of headlights, etc. of automobiles.

Specifications

Size	1.6×0.8mm to 5.7×5.0mm
Rated Voltage	DC10 to 1kV
Capacitance	220pF to 10μF
Main Applications	Battery lines and power trains for automobiles

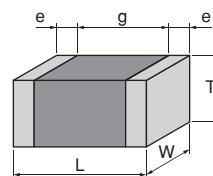

<Dimensions>

GCJ Series High Dielectric Constant Type AEC-Q200 Fail safe Deflecting crack Part Number List

■ 1.6x0.8mm

T max.	Rated Voltage	TC Code	Cap.	Tol.	Part Number		
0.9mm	100Vdc	X7R	1000pF	±10%	GCJ188R72A102KA01#		
			1200pF	±10%	GCJ188R72A122KA01#		
			1500pF	±10%	GCJ188R72A152KA01#		
			1800pF	±10%	GCJ188R72A182KA01#		
			2200pF	±10%	GCJ188R72A222KA01#		
			2700pF	±10%	GCJ188R72A272KA01#		
			3300pF	±10%	GCJ188R72A332KA01#		
			3900pF	±10%	GCJ188R72A392KA01#		
			4700pF	±10%	GCJ188R72A472KA01#		
			5600pF	±10%	GCJ188R72A562KA01#		
			6800pF	±10%	GCJ188R72A682KA01#		
			8200pF	±10%	GCJ188R72A822KA01#		
			10000pF	±10%	GCJ188R72A103KA01#		
			12000pF	±10%	GCJ188R72A123KA01#		
			15000pF	±10%	GCJ188R72A153KA01#		
			18000pF	±10%	GCJ188R72A183KA01#		
			22000pF	±10%	GCJ188R72A223KA01#		
			50Vdc	X7R	1000pF	±10%	GCJ188R71H102KA01#
					1200pF	±10%	GCJ188R71H122KA01#
					1500pF	±10%	GCJ188R71H152KA01#
	1800pF	±10%			GCJ188R71H182KA01#		
	2200pF	±10%			GCJ188R71H222KA01#		
	2700pF	±10%			GCJ188R71H272KA01#		
	3300pF	±10%			GCJ188R71H332KA01#		
	3900pF	±10%			GCJ188R71H392KA01#		
	25Vdc	X7R	4700pF	±10%	GCJ188R71H472KA01#		
			5600pF	±10%	GCJ188R71H562KA01#		
			6800pF	±10%	GCJ188R71H682KA01#		
8200pF			±10%	GCJ188R71H822KA01#			
10000pF			±10%	GCJ188R71H103KA01#			
12000pF			±10%	GCJ188R71H123KA01#			
15000pF			±10%	GCJ188R71H153KA01#			
18000pF			±10%	GCJ188R71H183KA01#			
22000pF			±10%	GCJ188R71H223KA01#			
33000pF			±10%	GCJ188R71H333KA12#			
39000pF			±10%	GCJ188R71H393KA12#			
47000pF			±10%	GCJ188R71H473KA12#			
56000pF	±10%	GCJ188R71H563KA12#					
68000pF	±10%	GCJ188R71H683KA12#					
82000pF	±10%	GCJ188R71H823KA12#					
0.10μF	±10%	GCJ188R71H104KA12#					
1000pF	±10%	GCJ188R71E102KA01#					
1200pF	±10%	GCJ188R71E122KA01#					
1500pF	±10%	GCJ188R71E152KA01#					
1800pF	±10%	GCJ188R71E182KA01#					
2200pF	±10%	GCJ188R71E222KA01#					
2700pF	±10%	GCJ188R71E272KA01#					
3300pF	±10%	GCJ188R71E332KA01#					
3900pF	±10%	GCJ188R71E392KA01#					
4700pF	±10%	GCJ188R71E472KA01#					
5600pF	±10%	GCJ188R71E562KA01#					
6800pF	±10%	GCJ188R71E682KA01#					

T max.	Rated Voltage	TC Code	Cap.	Tol.	Part Number		
0.9mm	25Vdc	X7R	8200pF	±10%	GCJ188R71E822KA01#		
			10000pF	±10%	GCJ188R71E103KA01#		
			12000pF	±10%	GCJ188R71E123KA01#		
			15000pF	±10%	GCJ188R71E153KA01#		
			18000pF	±10%	GCJ188R71E183KA01#		
			22000pF	±10%	GCJ188R71E223KA01#		
			27000pF	±10%	GCJ188R71E273KA01#		
			33000pF	±10%	GCJ188R71E333KA01#		
			39000pF	±10%	GCJ188R71E393KA01#		
			47000pF	±10%	GCJ188R71E473KA01#		
			56000pF	±10%	GCJ188R71E563KA12#		
			68000pF	±10%	GCJ188R71E683KA12#		
			82000pF	±10%	GCJ188R71E823KA12#		
			0.10μF	±10%	GCJ188R71E104KA12#		
			0.12μF	±10%	GCJ188R71E124KA01#		
			0.15μF	±10%	GCJ188R71E154KA01#		
			0.18μF	±10%	GCJ188R71E184KA12#		
			0.22μF	±10%	GCJ188R71E224KA12#		
			16Vdc	X7R	10000pF	±10%	GCJ188R71C103KA01#
					27000pF	±10%	GCJ188R71C273KA01#
	33000pF	±10%			GCJ188R71C333KA01#		
	39000pF	±10%			GCJ188R71C393KA01#		
	47000pF	±10%			GCJ188R71C473KA01#		
	56000pF	±10%			GCJ188R71C563KA01#		
	68000pF	±10%			GCJ188R71C683KA01#		
	82000pF	±10%			GCJ188R71C823KA01#		
	0.10μF	±10%			GCJ188R71C104KA01#		
	0.12μF	±10%			GCJ188R71C124KA01#		
	0.15μF	±10%			GCJ188R71C154KA01#		
	0.18μF	±10%			GCJ188R71C184KA01#		
	0.22μF	±10%			GCJ188R71C224KA01#		
	0.27μF	±10%			GCJ188R71C274KA01#		
	0.33μF	±10%			GCJ188R71C334KA01#		
	0.39μF	±10%			GCJ188R71C394KA12#		
	0.47μF	±10%	GCJ188R71C474KA12#				
	10Vdc	X7R	0.12μF	±10%	GCJ188R71A124KA01#		
0.15μF			±10%	GCJ188R71A154KA01#			
0.18μF			±10%	GCJ188R71A184KA01#			
0.22μF			±10%	GCJ188R71A224KA01#			

■ 2.0x1.25mm

T max.	Rated Voltage	TC Code	Cap.	Tol.	Part Number
0.7mm	100Vdc	X7R	1000pF	±10%	GCJ216R72A102KA01#
			1200pF	±10%	GCJ216R72A122KA01#
			1500pF	±10%	GCJ216R72A152KA01#
			1800pF	±10%	GCJ216R72A182KA01#
			2200pF	±10%	GCJ216R72A222KA01#
			2700pF	±10%	GCJ216R72A272KA01#
			3300pF	±10%	GCJ216R72A332KA01#
			3900pF	±10%	GCJ216R72A392KA01#
			4700pF	±10%	GCJ216R72A472KA01#
			5600pF	±10%	GCJ216R72A562KA01#

Part number # indicates the package specification code.

GCM Series
 GCJ Series
 GCD Series
 GCE Series
 GCG Series
 GC3 Series
 KCM Series
 KC3 Series
 ⚠Caution/Notice

GCJ Series High Dielectric Constant Type AEC-Q200 Fail safe Deflecting crack Part Number List

(→ ■ 2.0x1.25mm)

T max.	Rated Voltage	TC Code	Cap.	Tol.	Part Number	T max.	Rated Voltage	TC Code	Cap.	Tol.	Part Number		
0.7mm	100Vdc	X7R	6800pF	±10%	GCJ216R72A682KA01#	0.95mm	100Vdc	X7R	680pF	±10%	GCJ219R72A681KA01#		
			8200pF	±10%	GCJ216R72A822KA01#				820pF	±10%	GCJ219R72A821KA01#		
			10000pF	±10%	GCJ216R72A103KA01#				27000pF	±10%	GCJ219R72A273KA01#		
			12000pF	±10%	GCJ216R72A123KA01#				33000pF	±10%	GCJ219R72A333KA01#		
			15000pF	±10%	GCJ216R72A153KA01#				39000pF	±10%	GCJ219R72A393KA01#		
			18000pF	±10%	GCJ216R72A183KA01#				50Vdc	X7R	27000pF	±10%	GCJ219R71H273KA01#
			22000pF	±10%	GCJ216R72A223KA01#						33000pF	±10%	GCJ219R71H333KA01#
	50Vdc	X7R	330pF	±10%	GCJ216R71H331KA01#			39000pF			±10%	GCJ219R71H393KA01#	
			390pF	±10%	GCJ216R71H391KA01#			0.33μF	±10%	GCJ219R71H334KA12#			
			470pF	±10%	GCJ216R71H471KA01#			25Vdc	X7R	15000pF	±10%	GCJ219R71E153KA01#	
			560pF	±10%	GCJ216R71H561KA01#					18000pF	±10%	GCJ219R71E183KA01#	
			680pF	±10%	GCJ216R71H681KA01#					22000pF	±10%	GCJ219R71E223KA01#	
			820pF	±10%	GCJ216R71H821KA01#			0.33μF	±10%	GCJ219R71E334KA01#			
			1000pF	±10%	GCJ216R71H102KA01#			0.47μF	±10%	GCJ219R71E474KA12#			
			1200pF	±10%	GCJ216R71H122KA01#		16Vdc	X7R	0.68μF	±10%	GCJ219R71C684KA01#		
			1500pF	±10%	GCJ216R71H152KA01#				0.82μF	±10%	GCJ219R71C824KA01#		
			1800pF	±10%	GCJ216R71H182KA01#				1.0μF	±10%	GCJ219R71C105KA01#		
			2200pF	±10%	GCJ216R71H222KA01#		250Vdc	X7R	1000pF	±10%	GCJ21AR72E102KXJ1D		
			2700pF	±10%	GCJ216R71H272KA01#				1500pF	±10%	GCJ21AR72E152KXJ1D		
			3300pF	±10%	GCJ216R71H332KA01#				2200pF	±10%	GCJ21AR72E222KXJ1D		
			3900pF	±10%	GCJ216R71H392KA01#				3300pF	±10%	GCJ21AR72E332KXJ1D		
			4700pF	±10%	GCJ216R71H472KA01#				4700pF	±10%	GCJ21AR72E472KXJ1D		
			5600pF	±10%	GCJ216R71H562KA01#				6800pF	±10%	GCJ21AR72E682KXJ1D		
			6800pF	±10%	GCJ216R71H682KA01#				1.45mm	250Vdc	10000pF	±10%	GCJ21BR72E103KXJ3L
			8200pF	±10%	GCJ216R71H822KA01#						15000pF	±10%	GCJ21BR72E153KXJ3L
			10000pF	±10%	GCJ216R71H103KA01#				22000pF	±10%	GCJ21BR72E223KXJ3L		
			12000pF	±10%	GCJ216R71H123KA01#				100Vdc	X7R	47000pF	±10%	GCJ21BR72A473KA01#
			15000pF	±10%	GCJ216R71H153KA01#						56000pF	±10%	GCJ21BR72A563KA01#
18000pF	±10%	GCJ216R71H183KA01#	68000pF	±10%	GCJ21BR72A683KA01#								
22000pF	±10%	GCJ216R71H223KA01#	82000pF	±10%	GCJ21BR72A823KA01#								
25Vdc	X7R	470pF	±10%	GCJ216R71E471KA01#	0.10μF	±10%			GCJ21BR72A104KA01#				
		560pF	±10%	GCJ216R71E561KA01#	50Vdc	X7R	47000pF	±10%	GCJ21BR71H473KA01#				
		680pF	±10%	GCJ216R71E681KA01#			56000pF	±10%	GCJ21BR71H563KA01#				
		820pF	±10%	GCJ216R71E821KA01#			68000pF	±10%	GCJ21BR71H683KA01#				
		1000pF	±10%	GCJ216R71E102KA01#			82000pF	±10%	GCJ21BR71H823KA01#				
		1200pF	±10%	GCJ216R71E122KA01#			0.10μF	±10%	GCJ21BR71H104KA01#				
		1500pF	±10%	GCJ216R71E152KA01#			0.12μF	±10%	GCJ21BR71H124KA01#				
		1800pF	±10%	GCJ216R71E182KA01#			0.15μF	±10%	GCJ21BR71H154KA01#				
		2200pF	±10%	GCJ216R71E222KA01#			0.18μF	±10%	GCJ21BR71H184KA01#				
		2700pF	±10%	GCJ216R71E272KA01#			0.22μF	±10%	GCJ21BR71H224KA01#				
		3300pF	±10%	GCJ216R71E332KA01#			0.47μF	±10%	GCJ21BR71H474KA12#				
		3900pF	±10%	GCJ216R71E392KA01#			25Vdc	X7R	27000pF	±10%	GCJ21BR71E273KA01#		
		4700pF	±10%	GCJ216R71E472KA01#					33000pF	±10%	GCJ21BR71E333KA01#		
		5600pF	±10%	GCJ216R71E562KA01#					39000pF	±10%	GCJ21BR71E393KA01#		
		6800pF	±10%	GCJ216R71E682KA01#					47000pF	±10%	GCJ21BR71E473KA01#		
		8200pF	±10%	GCJ216R71E822KA01#	56000pF	±10%			GCJ21BR71E563KA01#				
		10000pF	±10%	GCJ216R71E103KA01#	68000pF	±10%			GCJ21BR71E683KA01#				
		12000pF	±10%	GCJ216R71E123KA01#	82000pF	±10%			GCJ21BR71E823KA01#				
		0.95mm	100Vdc	X7R	220pF	±10%			GCJ219R72A221KA01#	0.10μF	±10%	GCJ21BR71E104KA01#	
					270pF	±10%			GCJ219R72A271KA01#	0.27μF	±10%	GCJ21BR71E274KA01#	
					330pF	±10%			GCJ219R72A331KA01#	0.39μF	±10%	GCJ21BR71E394KA01#	
390pF	±10%				GCJ219R72A391KA01#	0.56μF			±10%	GCJ21BR71E564KA12#			
470pF	±10%				GCJ219R72A471KA01#	0.68μF			±10%	GCJ21BR71E684KA12#			
560pF	±10%				GCJ219R72A561KA01#	0.82μF			±10%	GCJ21BR71E824KA12#			

GCM Series
 GCJ Series
 GCD Series
 GCE Series
 GCG Series
 GC3 Series
 KCM Series
 KC3 Series
 ⚠Caution/Notice

Part number # indicates the package specification code.



GCJ Series High Dielectric Constant Type AEC-Q200 Fail safe Deflecting crack Part Number List

(→ ■ 2.0x1.25mm)

T max.	Rated Voltage	TC Code	Cap.	Tol.	Part Number
1.45mm	25Vdc	X7R	1.0μF	±10%	GCJ21BR71E105KA12#
			0.27μF	±10%	GCJ21BR71C274KA01#
	16Vdc	X7R	0.33μF	±10%	GCJ21BR71C334KA01#
			0.39μF	±10%	GCJ21BR71C394KA01#
			0.47μF	±10%	GCJ21BR71C474KA01#
			0.56μF	±10%	GCJ21BR71C564KA01#
			1.0μF	±10%	GCJ21BR71C105KA01#
			2.2μF	±10%	GCJ21BR71C225KA13#
10Vdc	X7R	2.2μF	±10%	GCJ21BR71A225KA01#	

■ 3.2x1.6mm

T max.	Rated Voltage	TC Code	Cap.	Tol.	Part Number		
0.95mm	100Vdc	X7R	0.10μF	±10%	GCJ319R72A104KA01#		
			50Vdc	X7R	0.10μF	±10%	GCJ319R71H104KA01#
				0.12μF	±10%	GCJ319R71H124KA01#	
1.25mm	1000Vdc	X7R	1000pF	±10%	GCJ31BR73A102KXJ1L		
			1500pF	±10%	GCJ31BR73A152KXJ1L		
			2200pF	±10%	GCJ31BR73A222KXJ1L		
			3300pF	±10%	GCJ31BR73A332KXJ1L		
			4700pF	±10%	GCJ31BR73A472KXJ1L		
			630Vdc	X7R	1000pF	±10%	GCJ31BR72J102KXJ1L
			1500pF	±10%	GCJ31BR72J152KXJ1L		
			2200pF	±10%	GCJ31BR72J222KXJ1L		
			3300pF	±10%	GCJ31BR72J332KXJ1L		
			4700pF	±10%	GCJ31BR72J472KXJ1L		
			6800pF	±10%	GCJ31BR72J682KXJ1L		
			10000pF	±10%	GCJ31BR72J103KXJ1L		
1.35mm	250Vdc	X7R	15000pF	±10%	GCJ31BR72E153KXJ1L		
			22000pF	±10%	GCJ31BR72E223KXJ1L		
			68000pF	±10%	GCJ31BR72E683KXJ1L		
			100Vdc	X7R	0.15μF	±10%	GCJ31MR72A154KA01#
					0.18μF	±10%	GCJ31MR72A184KA01#
					0.22μF	±10%	GCJ31MR72A224KA01#
	50Vdc	X7R	0.15μF	±10%	GCJ31MR71H154KA01#		
			0.18μF	±10%	GCJ31MR71H184KA01#		
			0.22μF	±10%	GCJ31MR71H224KA01#		
			0.27μF	±10%	GCJ31MR71H274KA01#		
			0.33μF	±10%	GCJ31MR71H334KA01#		
			0.39μF	±10%	GCJ31MR71H394KA01#		
			0.47μF	±10%	GCJ31MR71H474KA01#		
			0.56μF	±10%	GCJ31MR71H564KA12#		
			0.68μF	±10%	GCJ31MR71H684KA12#		
			0.82μF	±10%	GCJ31MR71H824KA12#		
			1.0μF	±10%	GCJ31MR71H105KA12#		
25Vdc		X7R	0.10μF	±10%	GCJ31MR71E104KA01#		
	0.12μF		±10%	GCJ31MR71E124KA01#			
	0.15μF		±10%	GCJ31MR71E154KA01#			
	0.18μF		±10%	GCJ31MR71E184KA01#			
	0.22μF		±10%	GCJ31MR71E224KA01#			
	1.0μF		±10%	GCJ31MR71E105KA01#			
	1.5μF		±10%	GCJ31MR71E155KA12#			
	2.2μF		±10%	GCJ31MR71E225KA12#			

T max.	Rated Voltage	TC Code	Cap.	Tol.	Part Number		
1.35mm	25Vdc	X7R	3.3μF	±10%	GCJ31MR71E335KA12#		
			1.0μF	±10%	GCJ31MR71C105KA01#		
				1.5μF	±10%	GCJ31MR71C155KA01#	
1.8mm	1000Vdc	X7R	6800pF	±10%	GCJ31CR73A682KXJ3L		
			10000pF	±10%	GCJ31CR73A103KXJ3L		
	630Vdc	X7R	15000pF	±10%	GCJ31CR72J153KXJ3L		
			22000pF	±10%	GCJ31CR72J223KXJ3L		
	250Vdc	X7R	33000pF	±10%	GCJ31CR72E333KXJ3L		
			47000pF	±10%	GCJ31CR72E473KXJ3L		
1.9mm	50Vdc	X7R	1.5μF	±10%	GCJ31CR71H155KA12#		
			2.2μF	±10%	GCJ31CR71H225KA12#		
	25Vdc	X7R	4.7μF	±10%	GCJ31CR71E475KA12#		
			3.3μF	±10%	GCJ31CR71C335KA01#		
			4.7μF	±10%	GCJ31CR71C475KA01#		
	16Vdc	X7R	10μF	±10%	GCJ31CR71C106KA15#		
			6.8μF	±10%	GCJ31CR71A685KA13#		
			10μF	±10%	GCJ31CR71A106KA13#		
			6.3Vdc	X7R	22μF	±10%	GCJ31CR70J226KE01#

■ 3.2x2.5mm

T max.	Rated Voltage	TC Code	Cap.	Tol.	Part Number
1.5mm	630Vdc	X7R	6800pF	±10%	GCJ32QR72J682KXJ1L
			10000pF	±10%	GCJ32QR72J103KXJ1L
		250Vdc	X7R	68000pF	±10%
2.0mm	1000Vdc	X7R	15000pF	±10%	GCJ32DR73A153KXJ1L
			22000pF	±10%	GCJ32DR73A223KXJ1L
			630Vdc	X7R	15000pF
			22000pF	±10%	GCJ32DR72J223KXJ1L
			33000pF	±10%	GCJ32DR72J333KXJ1L
			47000pF	±10%	GCJ32DR72J473KXJ1L
	250Vdc	X7R	0.10μF	±10%	GCJ32DR72E104KXJ1L
			0.22μF	±10%	GCJ32DR72E224KXJ1L
2.3mm	100Vdc	X7R	2.2μF	±10%	GCJ32DR72A225KA01#
2.8mm	50Vdc	X7R	4.7μF	±10%	GCJ32ER71H475KA12#
			25Vdc	X7R	10μF

■ 4.5x3.2mm

T max.	Rated Voltage	TC Code	Cap.	Tol.	Part Number
1.5mm	630Vdc	X7R	68000pF	±10%	GCJ43QR72J683KXJ1L
	250Vdc	X7R	0.15μF	±10%	GCJ43QR72E154KXJ1L
2.0mm	1000Vdc	X7R	33000pF	±10%	GCJ43DR73A333KXJ1L
			47000pF	±10%	GCJ43DR73A473KXJ1L
			630Vdc	X7R	33000pF
			47000pF	±10%	GCJ43DR72J473KXJ1L
			0.10μF	±10%	GCJ43DR72J104KXJ1L
		250Vdc	X7R	0.22μF	±10%
			0.33μF	±10%	GCJ43DR72E334KXJ1L
			0.47μF	±10%	GCJ43DR72E474KXJ1L

Part number # indicates the package specification code.

GCM Series
 GCJ Series
 GCD Series
 GCE Series
 GCG Series
 GC3 Series
 KCM Series
 KC3 Series
 ⚠Caution/Notice

GCJ Series High Dielectric Constant Type **AEC-Q200** **Fail safe** **Deflecting crack** **Part Number List**

■ 5.7×5.0mm

T max.	Rated Voltage	TC Code	Cap.	Tol.	Part Number
2.0mm	1000Vdc	X7R	68000pF	±10%	GCJ55DR73A683KXJ1L
			0.10μF	±10%	GCJ55DR73A104KXJ1L
	630Vdc	X7R	0.10μF	±10%	GCJ55DR72J104KXJ1L
			0.15μF	±10%	GCJ55DR72J154KXJ1L
			0.22μF	±10%	GCJ55DR72J224KXJ1L
	250Vdc	X7R	0.33μF	±10%	GCJ55DR72E334KXJ1L
			0.47μF	±10%	GCJ55DR72E474KXJ1L
			0.68μF	±10%	GCJ55DR72E684KXJ1L
			1.0μF	±10%	GCJ55DR72E105KXJ1L

GCM Series

GCJ Series

GCD Series

GCE Series

GCG Series

GC3 Series

KCM Series

KC3 Series

⚠Caution/Notice

Part number # indicates the package specification code.

Specially Designed Product to Reduce Shorts

GCD Series



AEC-Q200 **Fail safe** **Deflecting crack**

Prevents momentary dielectric breakdown by a two-element array structure!

Features

1 Prevents momentary dielectric breakdown by a two-element array structure!

This product consists of two elements arranged in one capacitor. It is structured so that even when one element is shorted, the other capacitor element will not short.

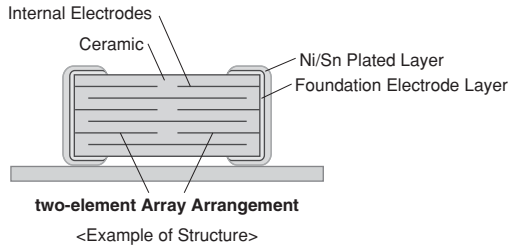

2 This AEC-Q200 conforming product is ideal for battery lines of automobiles.

Space can be reduced in battery lines where two capacitors are arranged in an array.

Specifications

Size	1.6×0.8mm to 2.0×1.25mm
Rated Voltage	DC25 to 100V
Capacitance	1,000pF to 0.1μF
Main Applications	Battery lines and power trains for automobiles

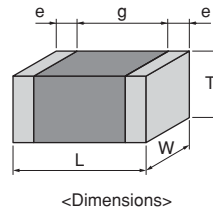

GCM Series

GCU Series

GCD Series

GCE Series

GCG Series

GCC Series

KCM Series

KC3 Series

⚠Caution/Notice

GCD Series High Dielectric Constant Type **AEC-Q200** **Fail safe** **Deflecting crack** **Part Number List**

■ 1.6x0.8mm

T max.	Rated Voltage	TC Code	Cap.	Tol.	Part Number		
0.9mm	100Vdc	X7R	1000pF	±10%	GCD188R72A102KA01#		
			1200pF	±10%	GCD188R72A122KA01#		
			1500pF	±10%	GCD188R72A152KA01#		
			1800pF	±10%	GCD188R72A182KA01#		
			2200pF	±10%	GCD188R72A222KA01#		
			2700pF	±10%	GCD188R72A272KA01#		
			3300pF	±10%	GCD188R72A332KA01#		
			3900pF	±10%	GCD188R72A392KA01#		
			4700pF	±10%	GCD188R72A472KA01#		
			50Vdc	X7R	1000pF	±10%	GCD188R71H102KA01#
					1200pF	±10%	GCD188R71H122KA01#
					1500pF	±10%	GCD188R71H152KA01#
	1800pF	±10%			GCD188R71H182KA01#		
	2200pF	±10%			GCD188R71H222KA01#		
	2700pF	±10%			GCD188R71H272KA01#		
	3300pF	±10%			GCD188R71H332KA01#		
	3900pF	±10%			GCD188R71H392KA01#		
	4700pF	±10%			GCD188R71H472KA01#		
	5600pF	±10%			GCD188R71H562KA01#		
	6800pF	±10%			GCD188R71H682KA01#		
	8200pF	±10%			GCD188R71H822KA01#		
	10000pF	±10%			GCD188R71H103KA01#		
	12000pF	±10%			GCD188R71H123KA01#		
	15000pF	±10%			GCD188R71H153KA01#		
	18000pF	±10%			GCD188R71H183KA01#		
	22000pF	±10%			GCD188R71H223KA01#		
	25Vdc	X7R			27000pF	±10%	GCD188R71E273KA01#
					33000pF	±10%	GCD188R71E333KA01#
					39000pF	±10%	GCD188R71E393KA01#
			47000pF	±10%	GCD188R71E473KA01#		

■ 2.0x1.25mm

T max.	Rated Voltage	TC Code	Cap.	Tol.	Part Number		
0.7mm	100Vdc	X7R	1000pF	±10%	GCD216R72A102KA01#		
			1200pF	±10%	GCD216R72A122KA01#		
			1500pF	±10%	GCD216R72A152KA01#		
			1800pF	±10%	GCD216R72A182KA01#		
			2200pF	±10%	GCD216R72A222KA01#		
			2700pF	±10%	GCD216R72A272KA01#		
			3300pF	±10%	GCD216R72A332KA01#		
			3900pF	±10%	GCD216R72A392KA01#		
			4700pF	±10%	GCD216R72A472KA01#		
			5600pF	±10%	GCD216R72A562KA01#		
			50Vdc	X7R	1000pF	±10%	GCD216R71H102KA01#
					1200pF	±10%	GCD216R71H122KA01#
	1500pF	±10%			GCD216R71H152KA01#		
	1800pF	±10%			GCD216R71H182KA01#		
	2200pF	±10%			GCD216R71H222KA01#		
	2700pF	±10%			GCD216R71H272KA01#		
	3300pF	±10%			GCD216R71H332KA01#		

T max.	Rated Voltage	TC Code	Cap.	Tol.	Part Number		
0.7mm	50Vdc	X7R	3900pF	±10%	GCD216R71H392KA01#		
			4700pF	±10%	GCD216R71H472KA01#		
			5600pF	±10%	GCD216R71H562KA01#		
0.95mm	100Vdc	X7R	6800pF	±10%	GCD219R72A682KA01#		
1.4mm	100Vdc	X7R	8200pF	±10%	GCD21BR72A822KA01#		
			10000pF	±10%	GCD21BR72A103KA01#		
			12000pF	±10%	GCD21BR72A123KA01#		
			50Vdc	X7R	15000pF	±10%	GCD21BR71H153KA01#
					18000pF	±10%	GCD21BR71H183KA01#
					22000pF	±10%	GCD21BR71H223KA01#
	27000pF	±10%			GCD21BR71H273KA01#		
	33000pF	±10%			GCD21BR71H333KA01#		
	39000pF	±10%			GCD21BR71H393KA01#		
	47000pF	±10%	GCD21BR71H473KA01#				
	56000pF	±10%	GCD21BR71H563KA01#				
	68000pF	±10%	GCD21BR71H683KA01#				
82000pF	±10%	GCD21BR71H823KA01#					
0.10µF	±10%	GCD21BR71H104KA01#					

GCM Series

GCU Series

GCD Series

GCE Series

GCG Series

GC3 Series

KCM Series

KC3 Series

⚠Caution/Notice

Part number # indicates the package specification code.

Specially Designed Product to Reduce Shorts & Resin Electrode Product

GCE Series



AEC-Q200 **Fail safe** **Deflecting crack**

Further improved safety performance with a combination of a two-element array structure & resin external electrodes!

Features

① Avoid instantaneous dielectric breakdown with the two-element array structure.

This product is configured with two elements arranged in one capacitor. Even if one element short circuits, the other element in the capacitor does not short.

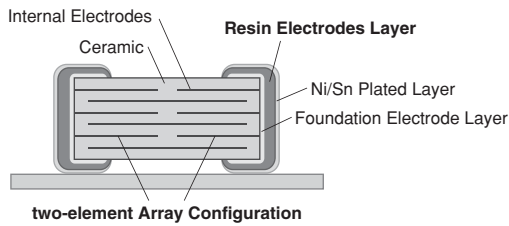

② Provides additional safety performance in combination with resin electrodes.

Adopting resin electrodes as the external electrodes will suppress the occurrence of cracking in the capacitor by mechanical stress.

● For Automobiles (GCM Series)

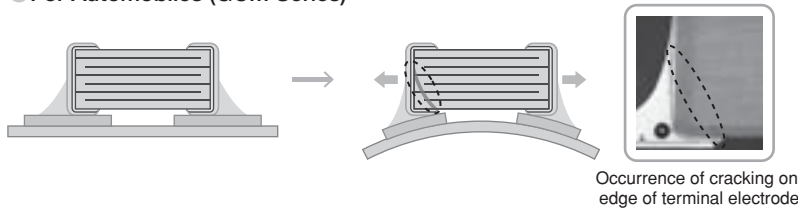

● Fail Safe Type (GCE Series)

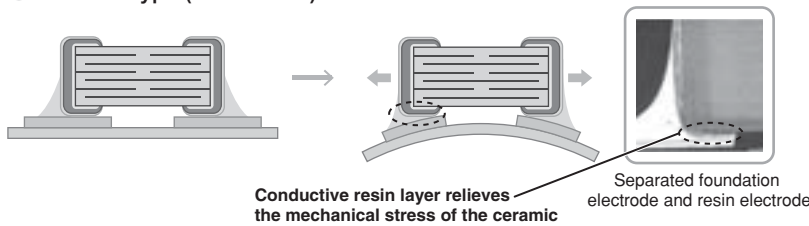

③ Ideal for battery lines of on-board applications.

Space can be reduced for battery lines, when two capacitors are configured in an array.

Specifications

Size	1.6×0.8mm to 2.0×1.25mm
Rated Voltage	DC50V, 100V
Capacitance	1000pF to 0.1μF
Main Applications	For automotive, battery lines, power trains

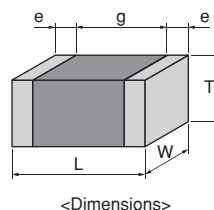

GCM Series
 GCU Series
 GCD Series
 GCE Series
 GCG Series
 GC3 Series
 KCM Series
 KC3 Series
 ⚠Caution/Notice

GCE Series High Dielectric Constant Type AEC-Q200 Fail safe Deflecting crack Part Number List

■ 1.6×0.8mm

T max.	Rated Voltage	TC Code	Cap.	Tol.	Part Number		
0.9mm	100Vdc	X7R	1000pF	±10%	GCE188R72A102KA01#		
			1200pF	±10%	GCE188R72A122KA01#		
			1500pF	±10%	GCE188R72A152KA01#		
			1800pF	±10%	GCE188R72A182KA01#		
			2200pF	±10%	GCE188R72A222KA01#		
			2700pF	±10%	GCE188R72A272KA01#		
			3300pF	±10%	GCE188R72A332KA01#		
			3900pF	±10%	GCE188R72A392KA01#		
			4700pF	±10%	GCE188R72A472KA01#		
			50Vdc	X7R	1000pF	±10%	GCE188R71H102KA01#
					1200pF	±10%	GCE188R71H122KA01#
					1500pF	±10%	GCE188R71H152KA01#
					1800pF	±10%	GCE188R71H182KA01#
					2200pF	±10%	GCE188R71H222KA01#
					2700pF	±10%	GCE188R71H272KA01#
	3300pF	±10%			GCE188R71H332KA01#		
	3900pF	±10%			GCE188R71H392KA01#		
	4700pF	±10%			GCE188R71H472KA01#		
	5600pF	±10%			GCE188R71H562KA01#		
	6800pF	±10%			GCE188R71H682KA01#		
	8200pF	±10%			GCE188R71H822KA01#		
	10000pF	±10%	GCE188R71H103KA01#				
	12000pF	±10%	GCE188R71H123KA01#				
	15000pF	±10%	GCE188R71H153KA01#				
	18000pF	±10%	GCE188R71H183KA01#				
	22000pF	±10%	GCE188R71H223KA01#				

T max.	Rated Voltage	TC Code	Cap.	Tol.	Part Number
1.45mm	100Vdc	X7R	8200pF	±10%	GCE21BR72A822KA01#
			10000pF	±10%	GCE21BR72A103KA01#
			12000pF	±10%	GCE21BR72A123KA01#
	50Vdc	X7R	15000pF	±10%	GCE21BR71H153KA01#
			18000pF	±10%	GCE21BR71H183KA01#
			22000pF	±10%	GCE21BR71H223KA01#
			27000pF	±10%	GCE21BR71H273KA01#
			33000pF	±10%	GCE21BR71H333KA01#
			39000pF	±10%	GCE21BR71H393KA01#
			47000pF	±10%	GCE21BR71H473KA01#
			56000pF	±10%	GCE21BR71H563KA01#
			68000pF	±10%	GCE21BR71H683KA01#
			82000pF	±10%	GCE21BR71H823KA01#
			0.10μF	±10%	GCE21BR71H104KA01#

■ 2.0×1.25mm

T max.	Rated Voltage	TC Code	Cap.	Tol.	Part Number			
0.7mm	100Vdc	X7R	1000pF	±10%	GCE216R72A102KA01#			
			1200pF	±10%	GCE216R72A122KA01#			
			1500pF	±10%	GCE216R72A152KA01#			
			1800pF	±10%	GCE216R72A182KA01#			
			2200pF	±10%	GCE216R72A222KA01#			
			2700pF	±10%	GCE216R72A272KA01#			
			3300pF	±10%	GCE216R72A332KA01#			
			3900pF	±10%	GCE216R72A392KA01#			
			4700pF	±10%	GCE216R72A472KA01#			
			5600pF	±10%	GCE216R72A562KA01#			
			50Vdc	X7R	1000pF	±10%	GCE216R71H102KA01#	
					1200pF	±10%	GCE216R71H122KA01#	
					1500pF	±10%	GCE216R71H152KA01#	
					1800pF	±10%	GCE216R71H182KA01#	
					2200pF	±10%	GCE216R71H222KA01#	
	2700pF	±10%			GCE216R71H272KA01#			
	3300pF	±10%			GCE216R71H332KA01#			
	3900pF	±10%			GCE216R71H392KA01#			
	4700pF	±10%			GCE216R71H472KA01#			
	5600pF	±10%			GCE216R71H562KA01#			
	0.95mm	100Vdc			X7R	6800pF	±10%	GCE219R72A682KA01#

Part number # indicates the package specification code.

Conductivity Adhesive Compatible Type

GCG Series



AEC-Q200

Deflecting crack

Soldering crack

Improved mechanical and thermal strength by adopting AgPd external electrodes, which can be mounted with a conductive adhesive!

Features

① **Conductive adhesives can be used.**

This capacitor can be mounted with a conductive adhesive* in power trains and safety devices of automobiles.

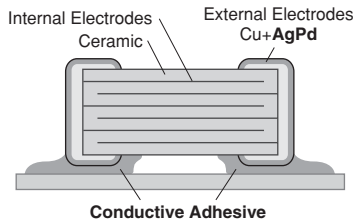

② **Adopted AgPd external electrodes.**

Adopted AgPd, which is excellent in bonding strength with a conductive adhesive.

③ **Compatible up to 150 °C.**

This capacitor lineup with X8L and X8R characteristics can be used in high-temperature environments, such as in ABS and transmission control.

* The conductive adhesive buffers the expansion and contraction difference between the substrate and parts caused by temperature changes, and has a high temperature cycle life span.

Specifications

Size	1.0x0.5mm to 3.2x2.5mm
Rated Voltage	DC16V to 50V
Capacitance	10pF to 10μF
Main Applications	For automotive, power trains, sensors

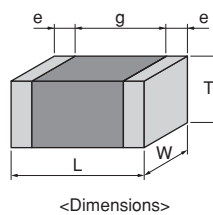

GCM Series

GCU Series

GCD Series

GCE Series

GCG Series

GCS Series

KCM Series

KC3 Series

⚠Caution/Notice

GCG Series Temperature Compensating Type AEC-Q200 Deflecting crack Soldering crack Part Number List

■ 1.6×0.8mm

T max.	Rated Voltage	TC Code	Cap.	Tol.	Part Number
0.9mm	50Vdc	X8G	10pF	±5%	GCG1885G1H100JA01#
			12pF	±5%	GCG1885G1H120JA01#
			15pF	±5%	GCG1885G1H150JA01#
			18pF	±5%	GCG1885G1H180JA01#
			22pF	±5%	GCG1885G1H220JA01#
			27pF	±5%	GCG1885G1H270JA01#
			33pF	±5%	GCG1885G1H330JA01#
			39pF	±5%	GCG1885G1H390JA01#
			47pF	±5%	GCG1885G1H470JA01#
			56pF	±5%	GCG1885G1H560JA01#
			68pF	±5%	GCG1885G1H680JA01#
			82pF	±5%	GCG1885G1H820JA01#
			100pF	±5%	GCG1885G1H101JA01#
			120pF	±5%	GCG1885G1H121JA01#
			150pF	±5%	GCG1885G1H151JA01#
			180pF	±5%	GCG1885G1H181JA01#
			220pF	±5%	GCG1885G1H221JA01#
			270pF	±5%	GCG1885G1H271JA01#
			330pF	±5%	GCG1885G1H331JA01#
			390pF	±5%	GCG1885G1H391JA01#
			470pF	±5%	GCG1885G1H471JA01#
			560pF	±5%	GCG1885G1H561JA01#
680pF	±5%	GCG1885G1H681JA01#			
820pF	±5%	GCG1885G1H821JA01#			
1000pF	±5%	GCG1885G1H102JA01#			
1200pF	±5%	GCG1885G1H122JA01#			
1500pF	±5%	GCG1885G1H152JA01#			
1800pF	±5%	GCG1885G1H182JA01#			
2200pF	±5%	GCG1885G1H222JA01#			

T max.	Rated Voltage	TC Code	Cap.	Tol.	Part Number
0.7mm	50Vdc	X8G	3300pF	±5%	GCG2165G1H332JA01#
			3900pF	±5%	GCG2165G1H392JA01#
			4700pF	±5%	GCG2165G1H472JA01#
0.95mm	50Vdc	X8G	5600pF	±5%	GCG2195G1H562JA01#
			6800pF	±5%	GCG2195G1H682JA01#
			8200pF	±5%	GCG2195G1H822JA01#
			10000pF	±5%	GCG2195G1H103JA01#

■ 2.0×1.25mm

T max.	Rated Voltage	TC Code	Cap.	Tol.	Part Number
0.7mm	50Vdc	X8G	100pF	±5%	GCG2165G1H101JA01#
			120pF	±5%	GCG2165G1H121JA01#
			150pF	±5%	GCG2165G1H151JA01#
			180pF	±5%	GCG2165G1H181JA01#
			220pF	±5%	GCG2165G1H221JA01#
			270pF	±5%	GCG2165G1H271JA01#
			330pF	±5%	GCG2165G1H331JA01#
			390pF	±5%	GCG2165G1H391JA01#
			470pF	±5%	GCG2165G1H471JA01#
			560pF	±5%	GCG2165G1H561JA01#
			680pF	±5%	GCG2165G1H681JA01#
			820pF	±5%	GCG2165G1H821JA01#
			1000pF	±5%	GCG2165G1H102JA01#
			1200pF	±5%	GCG2165G1H122JA01#
			1500pF	±5%	GCG2165G1H152JA01#
			1800pF	±5%	GCG2165G1H182JA01#
2200pF	±5%	GCG2165G1H222JA01#			
2700pF	±5%	GCG2165G1H272JA01#			

GCM Series

GCJ Series

GCD Series

GCE Series

GCG Series

GC3 Series

KCM Series

KC3 Series

⚠Caution/Notice

Part number # indicates the package specification code.

GCG Series High Dielectric Constant Type AEC-Q200 Deflecting crack Soldering crack Part Number List

■ 1.0x0.5mm

T max.	Rated Voltage	TC Code	Cap.	Tol.	Part Number		
0.55mm	50Vdc	X7R	220pF	±10%	GCG155R71H221KA01#		
			270pF	±10%	GCG155R71H271KA01#		
			330pF	±10%	GCG155R71H331KA01#		
			390pF	±10%	GCG155R71H391KA01#		
			470pF	±10%	GCG155R71H471KA01#		
			560pF	±10%	GCG155R71H561KA01#		
			680pF	±10%	GCG155R71H681KA01#		
			820pF	±10%	GCG155R71H821KA01#		
			1000pF	±10%	GCG155R71H102KA01#		
			1200pF	±10%	GCG155R71H122KA01#		
			1500pF	±10%	GCG155R71H152KA01#		
			1800pF	±10%	GCG155R71H182KA01#		
			2200pF	±10%	GCG155R71H222KA01#		
			2700pF	±10%	GCG155R71H272KA01#		
			3300pF	±10%	GCG155R71H332KA01#		
			3900pF	±10%	GCG155R71H392KA01#		
			4700pF	±10%	GCG155R71H472KA01#		
			25Vdc	X8L	5600pF	±10%	GCG155L81E562KA01#
					6800pF	±10%	GCG155L81E682KA01#
					8200pF	±10%	GCG155L81E822KA01#
10000pF	±10%	GCG155L81E103KA01#					
15000pF	±10%	GCG155L81E153KA01#					
X7R	5600pF	±10%		GCG155R71E562KA01#			
	6800pF	±10%		GCG155R71E682KA01#			
	8200pF	±10%		GCG155R71E822KA01#			
	10000pF	±10%		GCG155R71E103KA01#			
	15000pF	±10%		GCG155R71E153KA01#			
16Vdc	X8L	15000pF	±10%	GCG155L81C153KA01#			
		18000pF	±10%	GCG155L81C183KA01#			
		22000pF	±10%	GCG155L81C223KA01#			
		27000pF	±10%	GCG155L81C273KA01#			
		33000pF	±10%	GCG155L81C333KA01#			
		39000pF	±10%	GCG155L81C393KA01#			
		47000pF	±10%	GCG155L81C473KA01#			
		X7R	15000pF	±10%	GCG155R71C153KA01#		
			18000pF	±10%	GCG155R71C183KA01#		
			22000pF	±10%	GCG155R71C223KA01#		
	27000pF		±10%	GCG155R71C273KA01#			
	33000pF		±10%	GCG155R71C333KA01#			
	39000pF		±10%	GCG155R71C393KA01#			
	47000pF		±10%	GCG155R71C473KA01#			
	56000pF		±10%	GCG155R71C563KA01#			
	68000pF		±10%	GCG155R71C683KA01#			
	82000pF		±10%	GCG155R71C823KA01#			
	0.10μF	±10%	GCG155R71C104KA01#				

■ 1.6x0.8mm

T max.	Rated Voltage	TC Code	Cap.	Tol.	Part Number
0.9mm	50Vdc	X8L	220pF	±10%	GCG188L81H221KA01#
			270pF	±10%	GCG188L81H271KA01#
			330pF	±10%	GCG188L81H331KA01#
			390pF	±10%	GCG188L81H391KA01#

T max.	Rated Voltage	TC Code	Cap.	Tol.	Part Number		
0.9mm	50Vdc	X8L	470pF	±10%	GCG188L81H471KA01#		
			560pF	±10%	GCG188L81H561KA01#		
			680pF	±10%	GCG188L81H681KA01#		
			820pF	±10%	GCG188L81H821KA01#		
			1000pF	±10%	GCG188L81H102KA01#		
			1200pF	±10%	GCG188L81H122KA01#		
			1500pF	±10%	GCG188L81H152KA01#		
			1800pF	±10%	GCG188L81H182KA01#		
			2200pF	±10%	GCG188L81H222KA01#		
			2700pF	±10%	GCG188L81H272KA01#		
			3300pF	±10%	GCG188L81H332KA01#		
			3900pF	±10%	GCG188L81H392KA01#		
			4700pF	±10%	GCG188L81H472KA01#		
			5600pF	±10%	GCG188L81H562KA01#		
			6800pF	±10%	GCG188L81H682KA01#		
			8200pF	±10%	GCG188L81H822KA01#		
			10000pF	±10%	GCG188L81H103KA01#		
			12000pF	±10%	GCG188L81H123KA01#		
			15000pF	±10%	GCG188L81H153KA01#		
			18000pF	±10%	GCG188L81H183KA01#		
		22000pF	±10%	GCG188L81H223KA01#			
		X7R	27000pF	±10%	GCG188R71H273KA12#		
			33000pF	±10%	GCG188R71H333KA12#		
			39000pF	±10%	GCG188R71H393KA12#		
			47000pF	±10%	GCG188R71H473KA12#		
			56000pF	±10%	GCG188R71H563KA12#		
			68000pF	±10%	GCG188R71H683KA12#		
			82000pF	±10%	GCG188R71H823KA12#		
			25Vdc	X7R	0.12μF	±10%	GCG188R71E124KA12#
					0.15μF	±10%	GCG188R71E154KA12#
					0.18μF	±10%	GCG188R71E184KA12#
					0.22μF	±10%	GCG188R71E224KA12#
					16Vdc	X8L	0.15μF
			0.22μF	±10%			GCG188L81C224KA01#

■ 2.0x1.25mm

T max.	Rated Voltage	TC Code	Cap.	Tol.	Part Number			
1.45mm	50Vdc	X8L	27000pF	±10%	GCG21BL81H273KA01#			
			33000pF	±10%	GCG21BL81H333KA01#			
			39000pF	±10%	GCG21BL81H393KA01#			
			47000pF	±10%	GCG21BL81H473KA01#			
			0.10μF	±10%	GCG21BL81H104KA03#			
			X7R	0.15μF	±10%	GCG21BR71H154KA01#		
				0.18μF	±10%	GCG21BR71H184KA01#		
				0.22μF	±10%	GCG21BR71H224KA01#		
				25Vdc	X8L	0.10μF	±10%	GCG21BL81E104KA01#
						0.33μF	±10%	GCG21BL81E334KA01#
		X7R				0.27μF	±10%	GCG21BR71E274KA01#
						0.33μF	±10%	GCG21BR71E334KA01#
						0.39μF	±10%	GCG21BR71E394KA01#
				0.47μF	±10%	GCG21BR71E474KA01#		
		0.56μF		±10%	GCG21BR71E564KA01#			

Part number # indicates the package specification code.

GCM Series
 GCU Series
 GCD Series
 GCE Series
 GCG Series
 GC3 Series
 KCM Series
 KC3 Series
 ⚠Caution/Notice

GCG Series High Dielectric Constant Type AEC-Q200 Deflecting crack Soldering crack Part Number List

(→ ■ 2.0×1.25mm)

T max.	Rated Voltage	TC Code	Cap.	Tol.	Part Number
1.45mm	25Vdc	X7R	0.68μF	±10%	GCG21BR71E684KA01#
			0.82μF	±10%	GCG21BR71E824KA01#
			1.0μF	±10%	GCG21BR71E105KA12#
	16Vdc	X8L	0.33μF	±10%	GCG21BL81C334KA01#
			0.39μF	±10%	GCG21BL81C394KA01#
			0.47μF	±10%	GCG21BL81C474KA01#
			0.56μF	±10%	GCG21BL81C564KA01#
			0.68μF	±10%	GCG21BL81C684KA01#
			0.82μF	±10%	GCG21BL81C824KA01#

■ 3.2×1.6mm

T max.	Rated Voltage	TC Code	Cap.	Tol.	Part Number
1.35mm	25Vdc	X7R	1.0μF	±10%	GCG31MR71E105KA01#
			1.2μF	±10%	GCG31MR71E125KA01#
			1.5μF	±10%	GCG31MR71E155KA01#
			2.2μF	±10%	GCG31MR71E225KA12#
	16Vdc	X8L	1.0μF	±10%	GCG31ML81C105KA01#
			1.5μF	±10%	GCG31ML81C155KA01#
1.9mm	25Vdc	X7R	3.3μF	±10%	GCG31CR71E335KA01#
			3.9μF	±10%	GCG31CR71E395KA01#
			4.7μF	±10%	GCG31CR71E475KA01#
	16Vdc	X8L	3.3μF	±10%	GCG31CL81C335KA01#
			4.7μF	±10%	GCG31CL81C475KA01#

■ 3.2×2.5mm

T max.	Rated Voltage	TC Code	Cap.	Tol.	Part Number
2.3mm	25Vdc	X7R	3.3μF	±10%	GCG32DR71E335KA01#
2.8mm	25Vdc	X7R	4.7μF	±10%	GCG32ER71E475KA01#
			10μF	±10%	GCG32ER71E106KA12#

GCM Series

GCJ Series

GCD Series

GCE Series

GCG Series

GC3 Series

KCM Series

KC3 Series

△Caution/Notice

Part number # indicates the package specification code.

High Effective Capacitance & High Allowable Ripple Current

GC3 Series **AEC-Q200** **Anti-noise**

This is a high ripple resistance product for automobiles, excellent in DC voltage characteristics.

Features

- 1 When a DC voltage is applied, a capacitance higher than conventional products (X7R characteristics) can be acquired.

When DC600V is applied, about twice the capacitance can be secured.

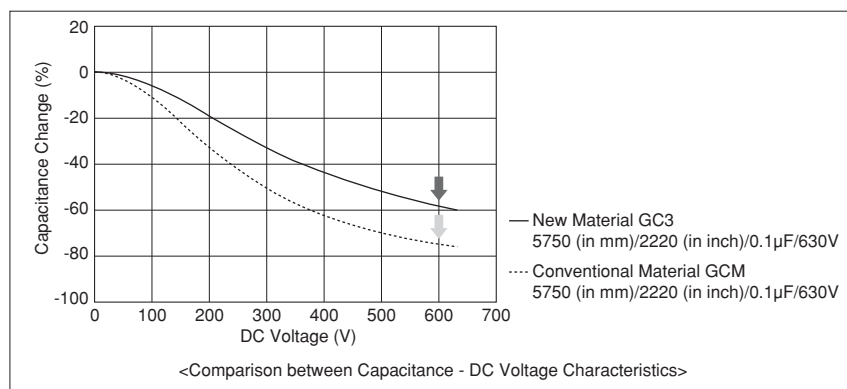

- 2 Improved ripple resistance performance compared to conventional products (X7R characteristics).

In the case of a product with a capacitance of 0.1μF, when the exothermic temperature reaches 20°C at frequency f=300kHz, the amount of resistance of a product with conventional material is 1.8Arms; however, the new material is 2.3 Arms.

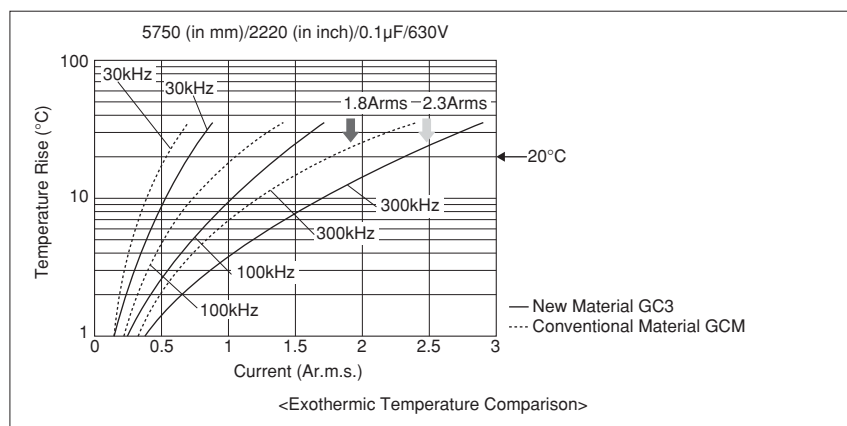

- 3 This product has a noise reduction effect.

Since dielectric materials that enable a reduction of noise are used, this product is more effective for reducing noise compared to the GCM series for automobiles.

Specifications

Size	2.0×1.25mm to 5.7×5.0mm
Rated Voltage	DC250 to 630V
Capacitance	0.01μF to 1.0μF
Main Applications	For PFC (Power Factor Correction) circuits of power supplies, EMI suppression, and smoothing circuits of automobiles

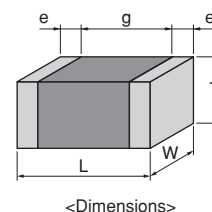

GCM Series
 GCJ Series
 GCD Series
 GCE Series
 GCG Series
GC3 Series
 KCM Series
 KC3 Series
 ⚠Caution/Notice

GC3 Series High Dielectric Constant Type AEC-Q200 Anti-noise Part Number List

■ 2.0×1.25mm

T max.	Rated Voltage	TC Code	Cap.	Tol.	Part Number
1.0mm	250Vdc	X7T	10000pF	±10%	GC321AD72E103KX01D
			15000pF	±10%	GC321AD72E153KX01D
1.45mm	250Vdc	X7T	22000pF	±10%	GC321BD72E223KX03L

T max.	Rated Voltage	TC Code	Cap.	Tol.	Part Number
2.7mm	630Vdc	X7T	0.27μF	±10%	GC355XD72J274KX05L
	450Vdc	X7T	0.56μF	±10%	GC355XD72W564KX05L
	250Vdc	X7T	1.0μF	±10%	GC355XD72E105KX05L

■ 3.2×1.6mm

T max.	Rated Voltage	TC Code	Cap.	Tol.	Part Number
1.0mm	450Vdc	X7T	10000pF	±10%	GC331AD72W103KX01D
			15000pF	±10%	GC331AD72W153KX01D
	250Vdc	X7T	33000pF	±10%	GC331AD72E333KX01D
1.25mm	630Vdc	X7T	10000pF	±10%	GC331BD72J103KX01L
	450Vdc	X7T	22000pF	±10%	GC331BD72W223KX01L
			33000pF	±10%	GC331BD72W333KX01L
250Vdc	X7T	47000pF	±10%	GC331BD72E473KX01L	
1.8mm	630Vdc	X7T	15000pF	±10%	GC331CD72J153KX03L
	450Vdc	X7T	47000pF	±10%	GC331CD72W473KX03L
	250Vdc	X7T	68000pF	±10%	GC331CD72E683KX03L

■ 3.2×2.5mm

T max.	Rated Voltage	TC Code	Cap.	Tol.	Part Number
1.5mm	630Vdc	X7T	22000pF	±10%	GC332QD72J223KX01L
	250Vdc	X7T	0.10μF	±10%	GC332QD72E104KX01L
2.0mm	630Vdc	X7T	33000pF	±10%	GC332DD72J333KX01L
			47000pF	±10%	GC332DD72J473KX01L
	450Vdc	X7T	68000pF	±10%	GC332DD72W683KX01L
			0.10μF	±10%	GC332DD72W104KX01L
	250Vdc	X7T	0.15μF	±10%	GC332DD72E154KX01L

■ 4.5×3.2mm

T max.	Rated Voltage	TC Code	Cap.	Tol.	Part Number
1.5mm	250Vdc	X7T	0.22μF	±10%	GC343QD72E224KX01L
2.0mm	630Vdc	X7T	68000pF	±10%	GC343DD72J683KX01L
	450Vdc	X7T	0.15μF	±10%	GC343DD72W154KX01L
	250Vdc	X7T	0.33μF	±10%	GC343DD72E334KX01L

■ 5.7×5.0mm

T max.	Rated Voltage	TC Code	Cap.	Tol.	Part Number
2.0mm	630Vdc	X7T	0.10μF	±10%	GC355DD72J104KX01L
			0.15μF	±10%	GC355DD72J154KX01L
	450Vdc	X7T	0.22μF	±10%	GC355DD72W224KX01L
			0.33μF	±10%	GC355DD72W334KX01L
			0.47μF	±10%	GC355DD72W474KX01L
	250Vdc	X7T	0.47μF	±10%	GC355DD72E474KX01L
0.68μF			±10%	GC355DD72E684KX01L	
2.7mm	630Vdc	X7T	0.22μF	±10%	GC355XD72J224KX05L

Part number # indicates the package specification code.

Metal Terminal Type

KCM Series



- AEC-Q200
- Anti-noise
- Deflecting crack
- Soldering crack

By bonding metal terminals to the external electrodes of the chip, the problem of how to design a capacitor to enable it to be mounted on a large MLCC has been solved!

Features

1 Bond the metal terminals to the external electrodes of the chip.

The stress on the chip is reduced due to the elastic behavior of the metal terminals.

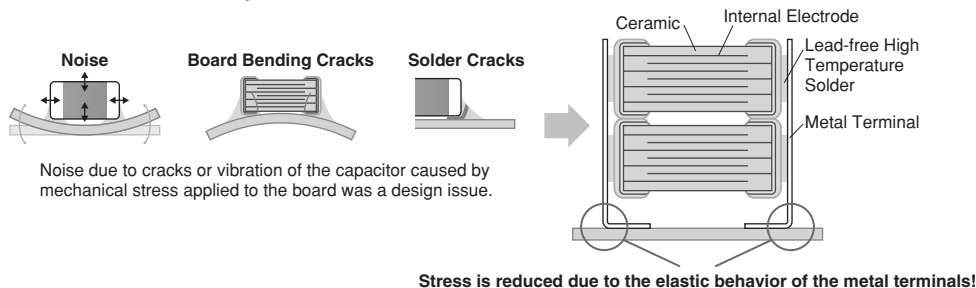

2 Noise, board deflection cracks, and solder cracks are greatly reduced.

No breakage occurs even when the board deflection is 6mm.
 Solder cracks were not found even after 2000 heat stress cycles.

Comparison of Noise Reduction Effect

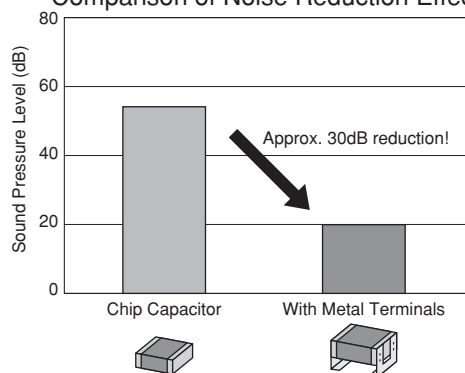

Evaluation Items: 2220 size/DC630V/220nF
 Test Conditions: 50V, AC10Vp-p/3kHz
 Sample Board: Glass-epoxy Board (T: 1.6mm)
 Number of samples: 3
 Distance between microphone and board: 3mm

Note: Results obtained using Murata's evaluation board

Stress caused by board deflection is reduced.

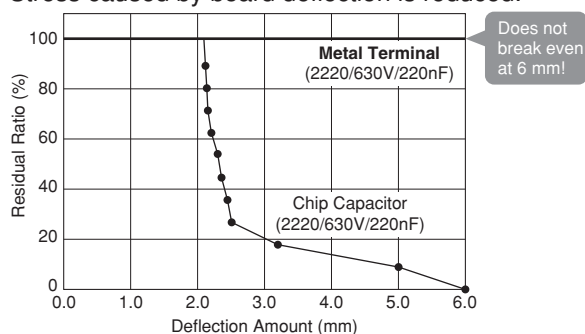

Solder cracks due to heat stress are reduced.

Chip Size	Individual Chip (2220 size)		Metal Terminal (2220 size)	
1000 cycles				
2000 cycles				

Compared to an individual chip, the addition of metal terminals results in excellent solder cracking resistance.

Test Conditions: -55 to +125°C, 5 minutes (liquid phase)
 Board used: Glass-epoxy Board (FR-4)

GCM Series
 GCJ Series
 GCD Series
 GCE Series
 GCG Series
 GC3 Series
 KCM Series
 KC3 Series
 ⚠Caution/Notice

③ Chip Stacking

A large capacitance can be realized by stacking two capacitors on top of each other.

Specifications

Size	6.1×5.3mm
Rated Voltage	DC25V to 100V
Capacitance	4.7μF to 47μF
Main Applications	For drive control of engine ECU, etc. For other drive system control and safety equipment

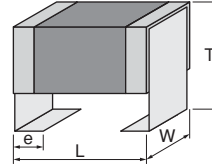

<Dimensions>

GCM Series

GCJ Series

GCD Series

GCE Series

GCG Series

GC3 Series

KCM Series

KC3 Series

△Caution/Notice

KCM Series High Dielectric Constant Type     **Part Number List**

■ 6.1×5.3mm

T max.	Rated Voltage	TC Code	Cap.	Tol.	Part Number
3.0mm	100Vdc	X7R	4.7μF	±10%	KCM55LR72A475KH01K
	63Vdc	X7R	4.7μF	±10%	KCM55LR71J475KH01K
	50Vdc	X7R	4.7μF	±10%	KCM55LR71H475KH01K
	35Vdc	X7R	10μF	±10%	KCM55LR7YA106KH01K
	25Vdc	X7R	15μF	±10%	KCM55LR71E156KH01K
3.9mm	100Vdc	X7R	6.8μF	±10%	KCM55QR72A685KH01K
	63Vdc	X7R	10μF	±10%	KCM55QR71J106KH01K
	50Vdc	X7R	10μF	±10%	KCM55QR71H106KH01K
	35Vdc	X7R	17μF	±10%	KCM55QR7YA176KH01K
	25Vdc	X7R	22μF	±10%	KCM55QR71E226KH01K
5.0mm	100Vdc	X7R	10μF	±20%	KCM55TR72A106MH01K
	35Vdc	X7R	22μF	±20%	KCM55TR7YA226MH01K
	25Vdc	X7R	33μF	±20%	KCM55TR71E336MH01K
6.7mm	100Vdc	X7R	15μF	±20%	KCM55WR72A156MH01K
	63Vdc	X7R	22μF	±20%	KCM55WR71J226MH01K
	50Vdc	X7R	22μF	±20%	KCM55WR71H226MH01K
	35Vdc	X7R	33μF	±20%	KCM55WR7YA336MH01K
	25Vdc	X7R	47μF	±20%	KCM55WR71E476MH01K

GCM Series

GCU Series

GCD Series

GCE Series

GCG Series

GCS Series

KCM Series

KCS Series

⚠Caution/Notice

Part number # indicates the package specification code.

Metal Terminal Type/High Effective Capacitance & High Allowable Ripple Current

KC3 Series **AEC-Q200** **Anti-noise** **Deflecting crack** **Soldering crack**

By bonding metal terminals to the external electrodes of the chip, the problem of how to design a capacitor to enable it to be mounted on a large MLCC has been solved!

Features

① Bond the metal terminals to the external electrodes of the chip.

The stress on the chip is reduced due to the elastic behavior of the metal terminals.

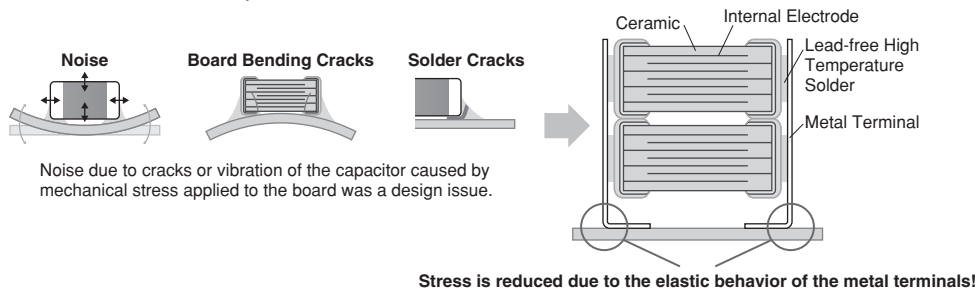

② Noise, board deflection cracks, and solder cracks are greatly reduced.

No breakage occurs even when the board deflection is 6mm.
 Solder cracks were not found even after 2000 heat stress cycles.

Comparison of Noise Reduction Effect

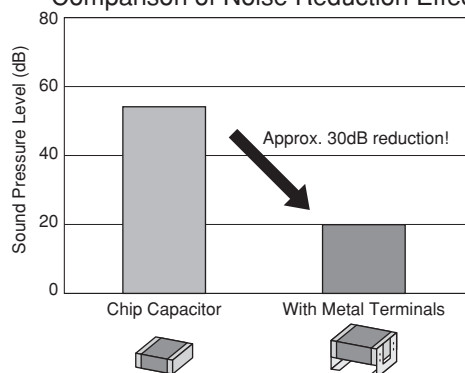



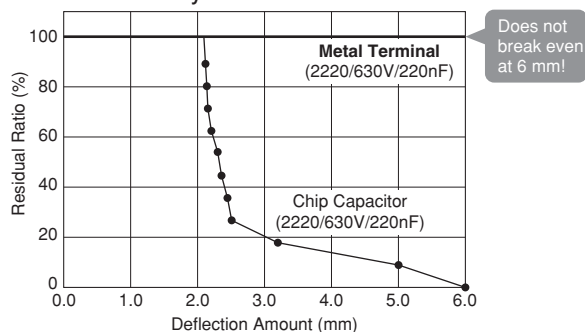

Evaluation Items: 2220 size/DC630V/220nF
 Test Conditions: 50V, AC10Vp-p/3kHz
 Sample Board: Glass-epoxy Board (T: 1.6mm)
 Number of samples: 3
 Distance between microphone and board: 3mm

Note: Results obtained using Murata's evaluation board

Stress caused by board deflection is reduced.

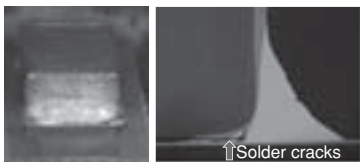

Solder cracks due to heat stress are reduced.

Chip Size	Individual Chip (2220 size)	Metal Terminal (2220 size)
1000 cycles	 ↑Solder cracks	
2000 cycles	 ↑Solder cracks	

Compared to an individual chip, the addition of metal terminals results in excellent solder cracking resistance.

Test Conditions: -55 to +125°C, 5 minutes (liquid phase)
 Board used: Glass-epoxy Board (FR-4)

3 Uses material of low dielectric constant.

Compared to a conventional capacitor (X7R characteristics), this series has higher effective capacitance and better anti-ripple performance.

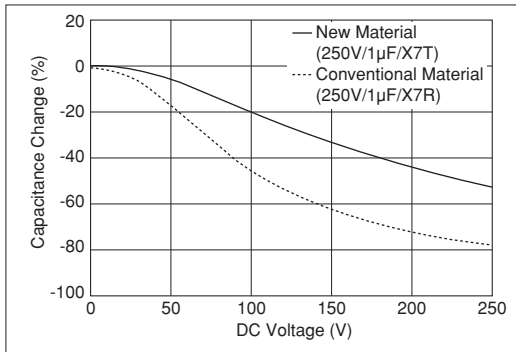

4 Chip Stacking

A large capacitance can be realized by stacking two capacitors on top of each other.

Specifications

Size	6.1×5.3mm
Rated Voltage	DC250V to 630V
Capacitance	0.1µF to 2.2µF
Main Applications	For drive control of engine ECU, etc. For other drive system control and safety equipment

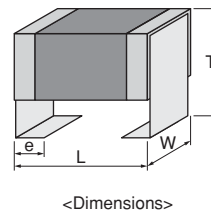

GCM Series

GCU Series

GCD Series

GCE Series

GCG Series

GCC Series

KCM Series

KC3 Series

⚠Caution/Notice

KC3 Series High Dielectric Constant Type **AEC-Q200** **Anti-noise** **Deflecting crack** **Soldering crack** **Part Number List**

■ 6.1×5.3mm

T max.	Rated Voltage	TC Code	Cap.	Tol.	Part Number
3.0mm	630Vdc	X7T	0.10μF	±10%	KC355LD72J104KH01K
			0.15μF	±10%	KC355LD72J154KH01K
	450Vdc	X7T	0.22μF	±10%	KC355LD72W224KH01K
			0.47μF	±10%	KC355LD72W474KH01K
250Vdc	X7T	0.47μF	±10%	KC355LD72E474KH01K	
3.9mm	630Vdc	X7T	0.22μF	±10%	KC355QD72J224KH01K
			0.27μF	±10%	KC355QD72J274KH01K
	450Vdc	X7T	0.56μF	±10%	KC355QD72W564KH01K
			1.0μF	±10%	KC355QD72E105KH01K
250Vdc	X7T	1.0μF	±10%	KC355QD72E105KH01K	
5.0mm	450Vdc	X7T	1.0μF	±20%	KC355TD72W105MH01K
6.7mm	630Vdc	X7T	0.47μF	±20%	KC355WD72J474MH01K
			0.56μF	±20%	KC355WD72J564MH01K
	450Vdc	X7T	1.2μF	±20%	KC355WD72W125MH01K
			2.2μF	±20%	KC355WD72E225MH01K
250Vdc	X7T	2.2μF	±20%	KC355WD72E225MH01K	

GCM Series

G CJ Series

GCD Series

GCE Series

GCG Series

GC3 Series

KCM Series

KC3 Series

⚠Caution/Notice

Part number # indicates the package specification code.

For Automotive

⚠Caution/Notice

⚠Caution

Notice

- Storage and Operation Conditions 45
- Rating 45
 - 1. Temperature Dependent Characteristics 45
 - 2. Measurement of Capacitance 46
 - 3. Applied Voltage 46
 - 4. Type of Applied Voltage and Self-heating Temperature 47
 - 5. DC Voltage and AC Voltage Characteristics 48
 - 6. Capacitance Aging 49
 - 7. Vibration and Shock 49
- Soldering and Mounting 49
 - 1. Mounting Position 49
 - 2. Information before Mounting 50
 - 3. Maintenance of the Mounting (pick and place) Machine 50
 - 4-1. Reflow Soldering 51
 - 4-2. Flow Soldering 52
 - 4-3. Correction with a Soldering Iron 53
 - 4-4. Leaded Component Insertion 54
 - 5. Washing 54
 - 6. Electrical Test on Printed Circuit Board 54
 - 7. Printed Circuit Board Cropping 54
 - 8. Selection of Conductive Adhesive, Mounting Process, and Bonding Strength 56
 - 9. Moisture Proof Process 56
 - 10. Application 56
- Other 56
 - 1. Under Operation of Equipment 56
 - 2. Other 56

- Rating 57
 - 1. Operating Temperature 57
 - 2. Atmosphere Surroundings 57
 - 3. Piezo-electric Phenomenon 57
- Soldering and Mounting 57
 - 1. PCB Design 57
 - 1. Notice for Pattern Forms 57
 - 2. Land Dimensions 58
 - 2. Adhesive Application 58
 - 3. Adhesive Curing 59
 - 4. Flux Application 59
 - 5. Flow Soldering 59
 - 6. Washing 59
 - 7. Coating 60
- Other 60
 - 1. Transportation 60
 - 2. Characteristics Evaluation in the Actual System 60

GCM Series

GCU Series

GCD Series

GCE Series

GCG Series

GCC Series

KCM Series

KC3 Series

⚠Caution/Notice



■ Storage and Operation Conditions

1. The performance of chip monolithic ceramic capacitors may be affected by the storage conditions.
 - 1-1. Store the capacitors in the following conditions:
Room Temperature of +5°C to +40°C and a Relative Humidity of 20% to 70%.
 - (1) Sunlight, dust, rapid temperature changes, corrosive gas atmosphere, or high temperature and humidity conditions during storage may affect solderability and packaging performance.
Please use product within six months of receipt.
 - (2) Please confirm solderability before using after six months. Store the capacitors without opening the original bag. Even if the storage period is short, do not exceed the specified atmospheric conditions.
 - 1-2. Corrosive gas can react with the termination (external) electrodes or lead wires of capacitors, and result in poor solderability. Do not store the capacitors in an atmosphere consisting of corrosive gas (e.g., hydrogen sulfide, sulfur dioxide, chlorine, ammonia gas, etc.).
 - 1-3. Due to moisture condensation caused by rapid humidity changes, or the photochemical change caused by direct sunlight on the terminal electrodes and/or the resin/epoxy coatings, the solderability and electrical performance may deteriorate. Do not store capacitors under direct sunlight or in high humidity conditions.
<Applicable to GCG Series>
 - 1-4. After unpacking, immediately reseal, or store in a desiccator containing a desiccant.

■ Rating

1. Temperature Dependent Characteristics

1. The electrical characteristics of a capacitor can change with temperature.
 - 1-1. For capacitors having larger temperature dependency, the capacitance may change with temperature changes.
The following actions are recommended in order to ensure suitable capacitance values.
 - (1) Select a suitable capacitance for the operating temperature range.
 - (2) The capacitance may change within the rated temperature.
When you use a high dielectric constant type capacitor in a circuit that needs a tight (narrow) capacitance tolerance (e.g., a time-constant circuit), please carefully consider the temperature characteristics, and carefully confirm the various characteristics in actual use conditions and the actual system.

[Typical Temperature Characteristics R7(X7R)]

Sample: 0.1μF, Rated Voltage 50VDC

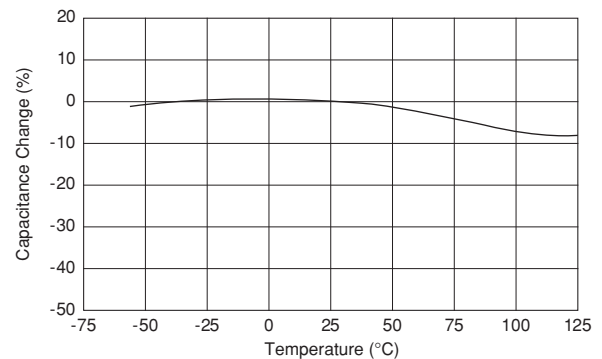

Continued on the following page. ↗

GCM Series

G CJ Series

GCD Series

GCE Series

GCG Series

GC3 Series

KCM Series

KC3 Series

Caution

⚠Caution

☐ Continued from the preceding page.

2. Measurement of Capacitance

1. Measure capacitance with the voltage and frequency specified in the product specifications.
 - 1-1. The output voltage of the measuring equipment may decrease occasionally when capacitance is high. Please confirm whether a prescribed measured voltage is impressed to the capacitor.
 - 1-2. The capacitance values of high dielectric constant type capacitors change depending on the AC voltage applied. Please consider the AC voltage characteristics when selecting a capacitor to be used in an AC circuit.

3. Applied Voltage

1. Do not apply a voltage to the capacitor that exceeds the rated voltage as called out in the specifications.
 - 1-1. Applied voltage between the terminals of a capacitor shall be less than or equal to the rated voltage.
 - (1) When AC voltage is superimposed on DC voltage, the zero-to-peak voltage shall not exceed the rated DC voltage.
 When AC voltage or pulse voltage is applied, the peak-to-peak voltage shall not exceed the rated DC voltage.
 - (2) Abnormal voltages (surge voltage, static electricity, pulse voltage, etc.) shall not exceed the rated DC voltage.

Typical Voltage Applied to the DC Capacitor

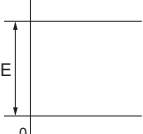
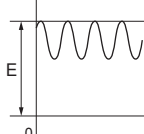
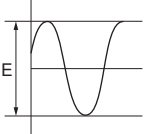
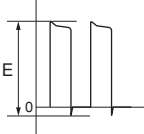
DC Voltage	DC Voltage+AC	AC Voltage	Pulse Voltage
			

(E: Maximum possible applied voltage.)

- 1-2. Influence of over voltage

Over voltage that is applied to the capacitor may result in an electrical short circuit caused by the breakdown of the internal dielectric layers.
 The time duration until breakdown depends on the applied voltage and the ambient temperature.
2. Use a safety standard certified capacitor in a power supply input circuit (AC filter), as it is also necessary to consider the withstand voltage and impulse withstand voltage defined for each device.

Continued on the following page. ☐

GCM Series

GCU Series

GCD Series

GCE Series

GCG Series

GCS Series

KCM Series

KC3 Series

⚠Caution



↳ Continued from the preceding page.

4. Type of Applied Voltage and Self-heating Temperature

1. Confirm the operating conditions to make sure that no large current is flowing into the capacitor due to the continuous application of an AC voltage or pulse voltage.

When a DC rated voltage product is used in an AC voltage circuit or a pulse voltage circuit, the AC current or pulse current will flow into the capacitor; therefore check the self-heating condition.

Please confirm the surface temperature of the capacitor so that the temperature remains within the upper limits of the operating temperature, including the rise in temperature due to self-heating. When the capacitor is used with a high-frequency voltage or pulse voltage, heat may be generated by dielectric loss.

<Applicable to Rated Voltage of less than 100VDC>

1-1. The load should be contained to the level such that when measuring at atmospheric temperature of 25°C, the product's self-heating remains below 20°C and the surface temperature of the capacitor in the actual circuit remains within the maximum operating temperature.

<Applicable to Temperature Characteristic X7R, X7T beyond Rated Voltage of 250VDC>

1-2. The load should be contained so that the self-heating of the capacitor body remains below 20°C, when measuring at an ambient temperature of 25°C. In addition, use a K thermocouple of $\phi 0.1$ mm with less heat capacity when measuring, and measure in a condition where there is no effect from the radiant heat of other components or air flow caused by convection. Excessive generation of heat may cause deterioration of the characteristics and reliability of the capacitor. (Absolutely do not perform measurements while the cooling fan is operating, as an accurate measurement may not be performed.)

<Applicable to Temperature Characteristic U2J beyond Rated Voltage of 250VDC>

1-3. Since the self-heating is low in the low loss series, the allowable power becomes extremely high compared to the common X7R characteristics.

However, when a load with self-heating of 20°C is applied at the rated voltage, the allowable power may be exceeded. When the capacitor is used in a high-frequency voltage circuit of 1kHz or more, the frequency of the applied voltage should be less than 500kHz sine wave (less than 100kHz for a product with rated voltage of DC3.15kV), to limit the voltage load so that the load remains within the derating shown in the following figure. In the case of non-sine wave, high-frequency components exceeding the fundamental frequency may be included. In such a case, please contact Murata. The excessive generation of heat may cause deterioration of the characteristics and reliability of the capacitor.

(Absolutely do not perform measurements while the cooling fan is operating, as an accurate measurement may not be performed.)

[Example of Temperature Rise (Heat Generation) in Chip Monolithic Ceramic Capacitors in Contrast to Ripple Current]

Sample: R characteristics 10 μ F, Rated voltage: DC10V

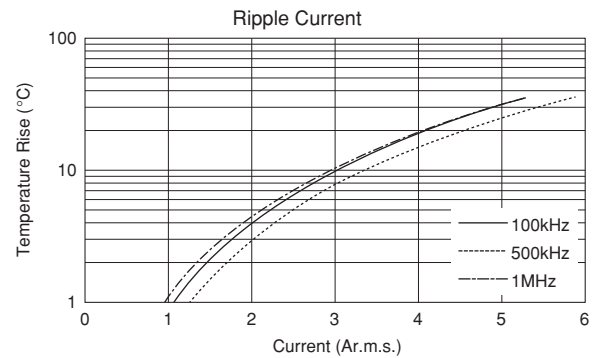

The temperature of the surface of capacitor: 125°C or less (including self-heating)

U2J char., Rated Voltage: DC250V

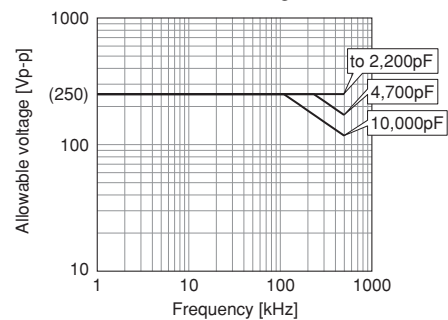

U2J char., Rated Voltage: DC630V

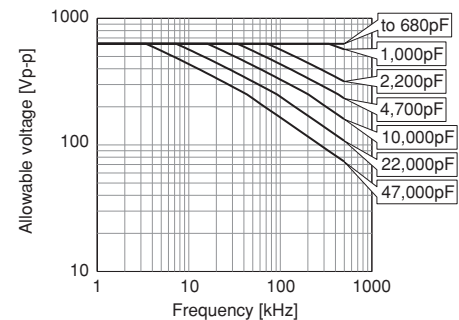

U2J char., Rated Voltage: DC1kV

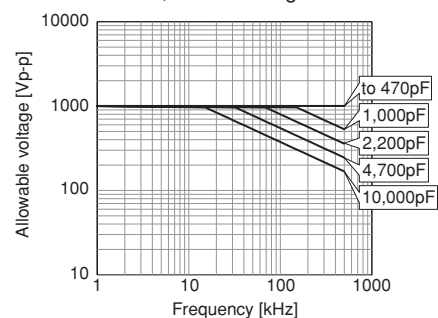

Sine-wave frequency VS allowable voltage

Continued on the following page. ↗

⚠Caution

↳ Continued from the preceding page.

<Design Tool>

• Simsurfing

Simsurfing is a web application to display the characteristics charts and download the characteristics data of our products. The frequency characteristics, temperature characteristics, bias characteristics etc. can be checked.

(Address: <http://www.murata.com/simsurfing/>)

• Medium Voltage Ceramic Capacitor Selection Tool

The selection tool "Murata Medium Voltage Capacitors Selection Tool by Voltage Form" is installed in the above SimSurfing, where the usability of the preferred medium voltage ceramic capacitors can be determined according to the application including automobiles.

By using this tool, the preferred products* can be checked by specifications, such as the power, voltage, and fundamental frequency of the voltage waveform to be input into the capacitor.

*Supported Series

Temperature characteristic U2J of GCM/DC250V or more

GCM Series

GCU Series

GCD Series

GCE Series

GCG Series

GCC Series

KCM Series

KC3 Series

⚠Caution

5. DC Voltage and AC Voltage Characteristics

1. The capacitance value of a high dielectric constant type capacitor changes depending on the DC voltage applied. Please consider the DC voltage characteristics when a capacitor is selected for use in a DC circuit.

1-1. The capacitance of ceramic capacitors may change sharply depending on the applied voltage (see figure).

Please confirm the following in order to secure the capacitance.

- (1) Determine whether the capacitance change caused by the applied voltage is within the allowed range.
- (2) In the DC voltage characteristics, the rate of capacitance change becomes larger as voltage increases, even if the applied voltage is below the rated voltage. When a high dielectric constant type capacitor is used in a circuit that requires a tight (narrow) capacitance tolerance (e.g., a time constant circuit), please carefully consider the voltage characteristics, and confirm the various characteristics in actual operating conditions in an actual system.

2. The capacitance values of high dielectric constant type capacitors changes depending on the AC voltage applied. Please consider the AC voltage characteristics when selecting a capacitor to be used in an AC circuit.

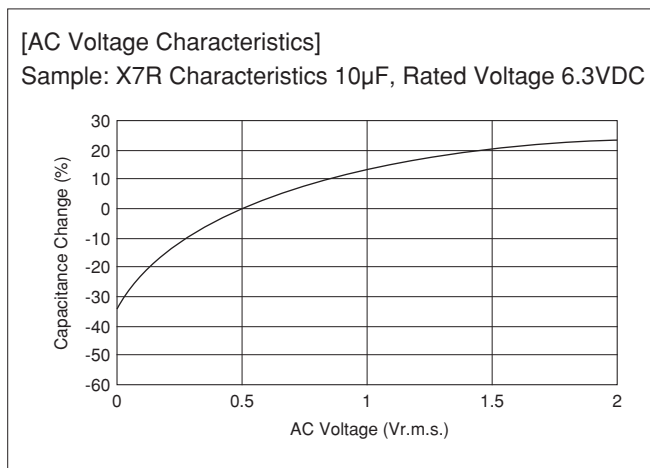
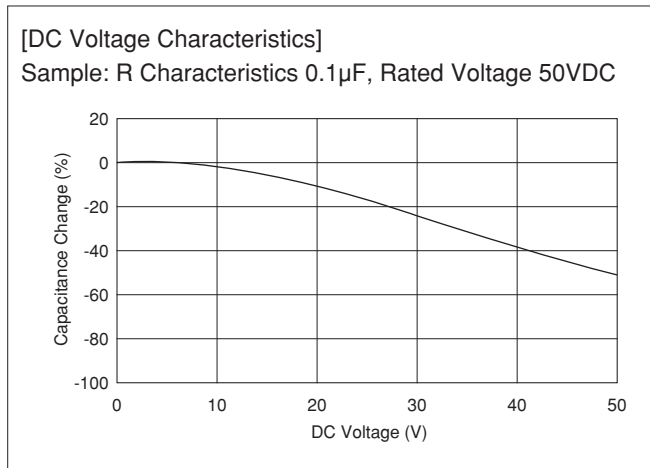

Continued on the following page. ↗

⚠Caution

↳ Continued from the preceding page.

6. Capacitance Aging

1. The high dielectric constant type capacitors have the characteristic in which the capacitance value decreases with the passage of time.

When you use high dielectric constant type capacitors in a circuit that needs a tight (narrow) capacitance tolerance (e.g., a time-constant circuit), please carefully consider the characteristics of these capacitors, such as their aging, voltage, and temperature characteristics. In addition, check capacitors using your actual appliances at the intended environment and operating conditions.

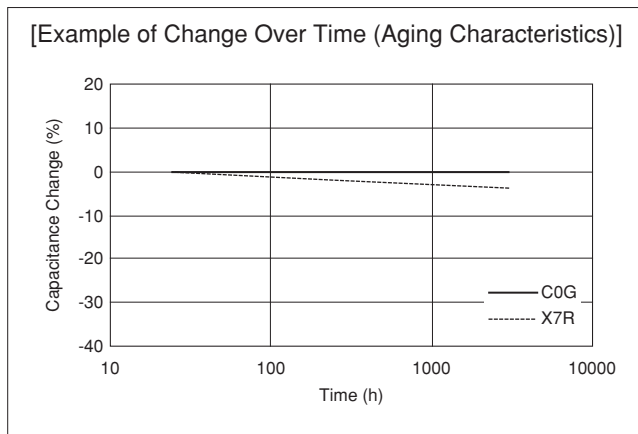

7. Vibration and Shock

1. Please confirm the kind of vibration and/or shock, its condition, and any generation of resonance. Please mount the capacitor so as not to generate resonance, and do not allow any impact on the terminals.

2. Mechanical shock due to being dropped may cause damage or a crack in the dielectric material of the capacitor. Do not use a dropped capacitor because the quality and reliability may be deteriorated.

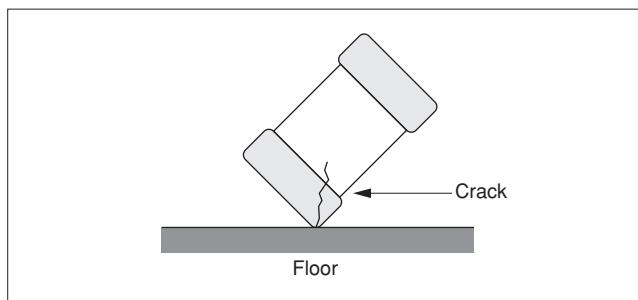

3. When printed circuit boards are piled up or handled, the corner of another printed circuit board should not be allowed to hit the capacitor, in order to avoid a crack or other damage to the capacitor.

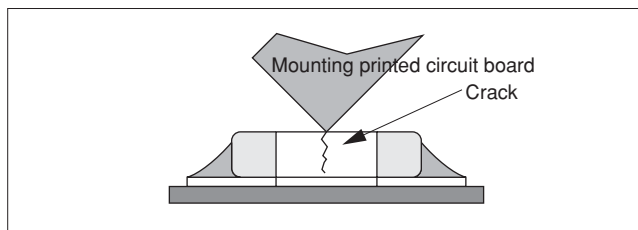

■ Soldering and Mounting

1. Mounting Position

1. Confirm the best mounting position and direction that minimizes the stress imposed on the capacitor during flexing or bending the printed circuit board.

1-1. Choose a mounting position that minimizes the stress imposed on the chip during flexing or bending of the board.

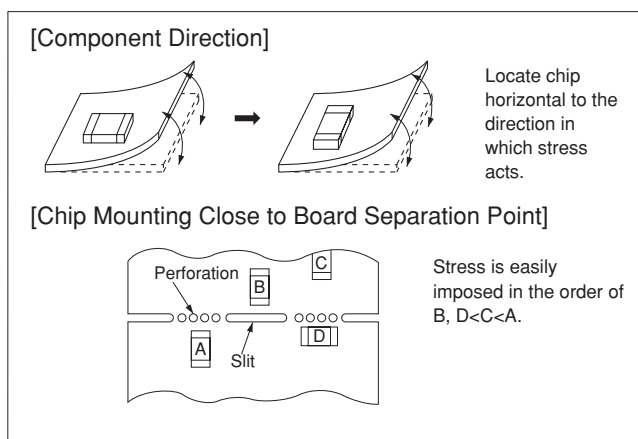

Continued on the following page. ↗

GCM Series

GCJ Series

GCD Series

GCE Series

GCG Series

GC3 Series

KCM Series

KC3 Series

⚠Caution

⚠Caution

☐ Continued from the preceding page.

2. Information before Mounting

1. Do not re-use capacitors that were removed from the equipment.
2. Confirm capacitance characteristics under actual applied voltage.
3. Confirm the mechanical stress under actual process and equipment use.
4. Confirm the rated capacitance, rated voltage and other electrical characteristics before assembly.
5. Prior to use, confirm the solder ability of capacitors that were in long-term storage.
6. Prior to measuring capacitance, carry out a heat treatment for capacitors that were in long-term storage.
7. The use of Sn-Zn based solder will deteriorate the reliability of the MLCC.
Please contact our sales representative or product engineers on the use of Sn-Zn based solder in advance.

3. Maintenance of the Mounting (pick and place) Machine

1. Make sure that the following excessive forces are not applied to the capacitors.
 - 1-1. In mounting the capacitors on the printed circuit board, any bending force against them shall be kept to a minimum to prevent them from any bending damage or cracking. Please take into account the following precautions and recommendations for use in your process.
 - (1) Adjust the lowest position of the pickup nozzle so as not to bend the printed circuit board.
 - (2) Adjust the nozzle pressure within a static load of 1N to 3N during mounting.
2. Dirt particles and dust accumulated between the suction nozzle and the cylinder inner wall prevent the nozzle from moving smoothly. This imposes greater force upon the chip during mounting, causing cracked chips. Also, the locating claw, when worn out, imposes uneven forces on the chip when positioning, causing cracked chips. The suction nozzle and the locating claw must be maintained, checked, and replaced periodically.

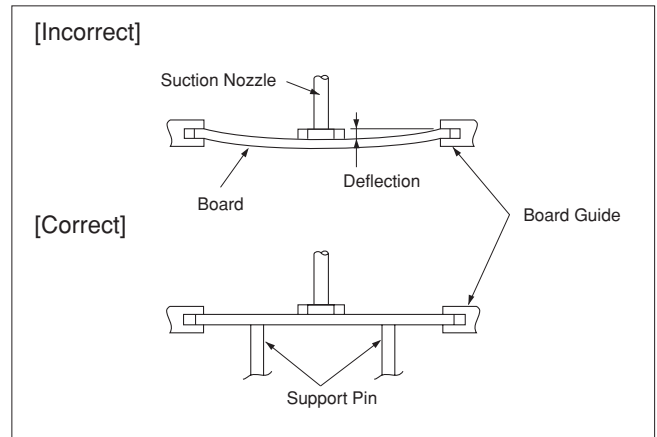

Continued on the following page. ☐

GCM Series

GCU Series

GCD Series

GCE Series

GCG Series

GCC Series

KCM Series

KC3 Series

⚠Caution

⚠Caution

☐ Continued from the preceding page.

4-1. Reflow Soldering

1. When sudden heat is applied to the components, the mechanical strength of the components will decrease because a sudden temperature change causes deformation inside the components. In order to prevent mechanical damage to the components, preheating is required for both the components and the PCB. Preheating conditions are shown in table 1. It is required to keep the temperature differential between the solder and the components surface (ΔT) as small as possible.
2. Solder ability of tin plating termination chips might be deteriorated when a low temperature soldering profile where the peak solder temperature is below the melting point of tin is used. Please confirm the solder ability of tin plated termination chips before use.
3. When components are immersed in solvent after mounting, be sure to maintain the temperature difference (ΔT) between the component and the solvent within the range shown in table 1.

Table 1

Part Number	Temperature Differential
GC3/GCD/GCE/GCJ/GCM Series 03/15/18/21/31 sizes	$\Delta T \leq 190^\circ\text{C}$
GCJ/GCM Series 32/43/55 sizes KC3/KCM Series 55 size	$\Delta T \leq 130^\circ\text{C}$

Recommended Conditions

	Pb-Sn Solder		Lead Free Solder
	Reflow	Vapor Reflow	
Peak Temperature	230 to 250°C	230 to 240°C	240 to 260°C
Atmosphere	Air	Saturated vapor of inactive solvent	Air or N ₂

Pb-Sn Solder: Sn-37Pb
 Lead Free Solder: Sn-3.0Ag-0.5Cu

4. Optimum Solder Amount for Reflow Soldering

- 4-1. Overly thick application of solder paste results in a excessive solder fillet height. This makes the chip more susceptible to mechanical and thermal stress on the board and may cause the chips to crack.
- 4-2. Too little solder paste results in a lack of adhesive strength on the outer electrode, which may result in chips breaking loose from the PCB.
- 4-3. Make sure the solder has been applied smoothly to the end surface to a height of 0.2mm* min.

Inverting the PCB

Make sure not to impose any abnormal mechanical shocks to the PCB.

[Standard Conditions for Reflow Soldering]

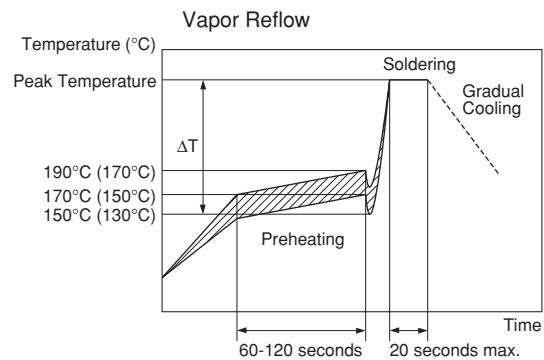
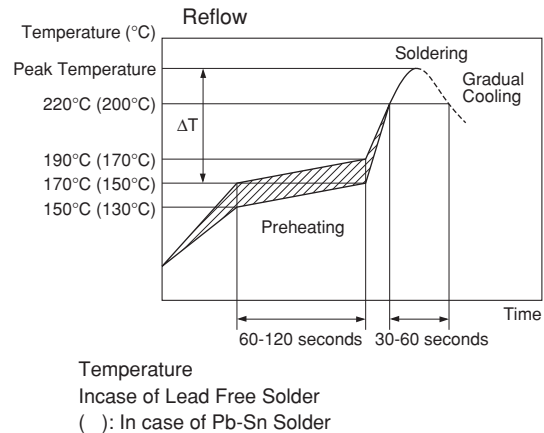

[Allowable Reflow Soldering Temperature and Time]

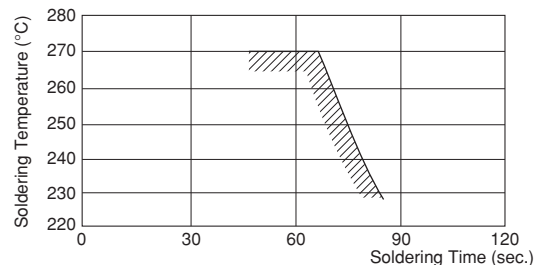

In the case of repeated soldering, the accumulated soldering time must be within the range shown above.

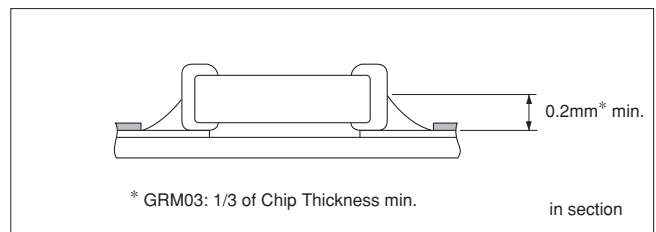

Continued on the following page. ↗

GCM Series

GCJ Series

GCD Series

GCE Series

GCG Series

GC3 Series

KCM Series

KC3 Series

⚠Caution

⚠Caution

☐ Continued from the preceding page.

4-2. Flow Soldering

1. Do not apply flow soldering to chips not listed in table 2.

Table 2

Part Number	Temperature Differential
GC3/GCD/GCM Series 18/21/31 sizes (Except for characteristics of X8L, X8G)	$\Delta T \leq 150^{\circ}\text{C}$
GCJ Series Rated Voltage 250VDC or more 18/21/31 sizes	

2. When sudden heat is applied to the components, the mechanical strength of the components will decrease because a sudden temperature change causes deformation inside the components. In order to prevent mechanical damage to the components, preheating is required for both of the components and the PCB board. Preheating conditions are shown in table 2. It is required to keep the temperature differential between the solder and the components surface (ΔT) as low as possible.
3. Excessively long soldering time or high soldering temperature can result in leaching of the outer electrodes, causing poor adhesion or a reduction in capacitance value due to loss of contact between the electrodes and end termination.
4. When components are immersed in solvent after mounting, be sure to maintain the temperature differential (ΔT) between the component and solvent within the range shown in the table 2.

Recommended Conditions

	Pb-Sn Solder	Lead Free Solder
Preheating Peak Temperature	90 to 110°C	100 to 120°C
Soldering Peak Temperature	240 to 250°C	250 to 260°C
Atmosphere	Air	N ₂

Pb-Sn Solder: Sn-37Pb
 Lead Free Solder: Sn-3.0Ag-0.5Cu

5. Optimum Solder Amount for Flow Soldering

5-1. The top of the solder fillet should be lower than the thickness of the components. If the solder amount is excessive, the risk of cracking is higher during board bending or any other stressful condition.

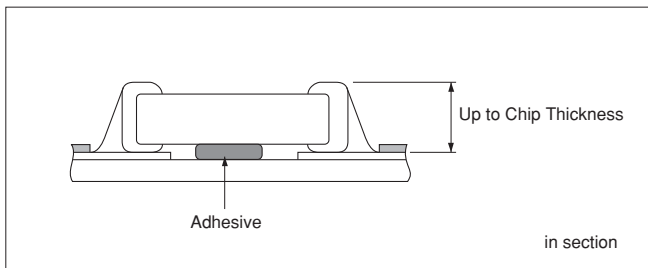
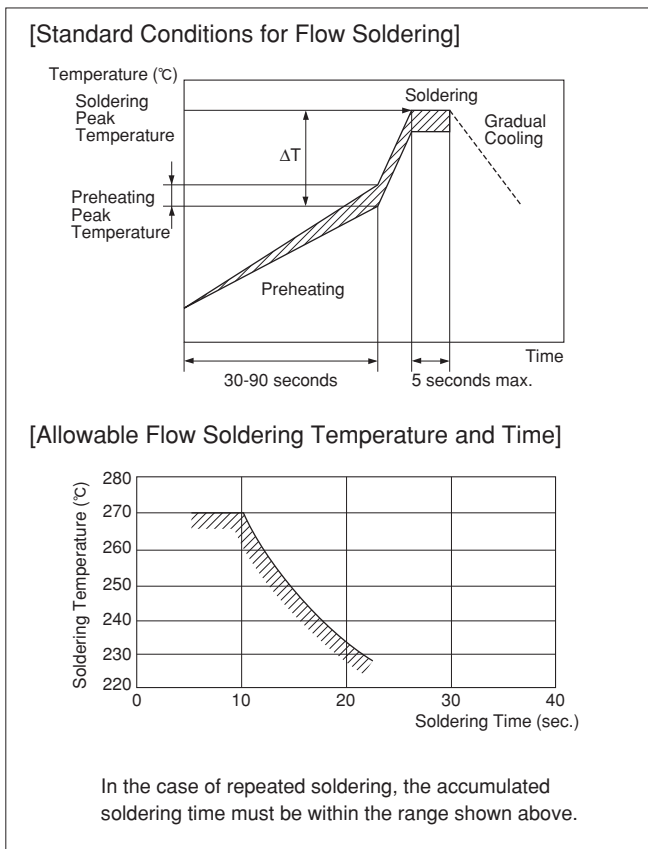

Continued on the following page. ☐

GCM Series

GCJ Series

GCD Series

GCE Series

GCG Series

GC3 Series

KCM Series

KC3 Series

⚠Caution

⚠Caution

☐ Continued from the preceding page.

4-3. Correction with a Soldering Iron

1. When sudden heat is applied to the components when using a soldering iron, the mechanical strength of the components will decrease because the extreme temperature change can cause deformations inside the components. In order to prevent mechanical damage to the components, preheating is required for both the components and the PCB board. Preheating conditions (the "Temperature of the Soldering Iron Tip," "Preheating Temperature," and "Temperature Differential" between the iron tip and the components and the PCB), should be within the conditions of table 3. It is required to keep the temperature differential between the soldering iron and the component surfaces (ΔT) as low as possible.
2. After soldering, do not allow the component/PCB to cool down rapidly.
3. The operating time for the re-working should be as short as possible. When re-working time is too long, it may cause solder leaching, resulting in a reduction in the adhesive strength of the terminations.
4. Optimum solder amount when re-working with a soldering iron
 - 4-1. In the case of sizes smaller than 0603, (GC3/GCD/GCE/GCJ/GCM Series, 03/15/18 sizes), the top of the solder fillet should be lower than $\frac{2}{3}$ of the thickness of the component or 0.5mm, whichever is smaller. In the case of 0805 and larger sizes, (GC3/GCD/GCE/GCJ/GCM Series, 21/31/32/43/55 sizes), the top of the solder fillet should be lower than $\frac{2}{3}$ of the thickness of the component. If the solder amount is excessive, the risk of cracking is higher during board bending or under any other stressful condition.
 - 4-2. A soldering iron with a tip of $\phi 3\text{mm}$ or smaller should be used. It is also necessary to keep the soldering iron from touching the components during the re-work.
 - 4-3. Solder wire with $\phi 0.5\text{mm}$ or smaller is required for soldering.

<Applicable to KC3/KCM Series>

5. For the shape of the soldering iron tip, refer to the figure on the right.
 Regarding the type of solder, use a wire diameter of $\phi 0.5\text{mm}$ or less (rosin core wire solder).

How to Apply the Soldering Iron

Apply the tip of the soldering iron against the lower end of the metal terminal.

- 1) In order to prevent cracking caused by sudden heating of the ceramic device, do not touch the ceramic base directly.
- 2) In order to prevent deviations and dislocating of the chip, do not touch the junction of the chip and the metal terminal, and the metal portion on the outside directly.

Appropriate Amount of Solder

The amount of solder for corrections by soldering iron, should be lower than the height of the lower side of the chip.

Table 3

Part Number	Temperature of Soldering Iron Tip	Preheating Temperature	Temperature Differential (ΔT)	Atmosphere
GC3/GCD/GCE/ GCJ/GCM Series 03/15/18/21/31 sizes	350°C max.	150°C min.	$\Delta T \leq 190^\circ\text{C}$	Air
GCJ/GCM Series 32/43/55 sizes	280°C max.	150°C min.	$\Delta T \leq 130^\circ\text{C}$	Air

*Applicable for both Pb-Sn and Lead Free Solder.
 Pb-Sn Solder: Sn-37Pb
 Lead Free Solder: Sn-3.0Ag-0.5Cu

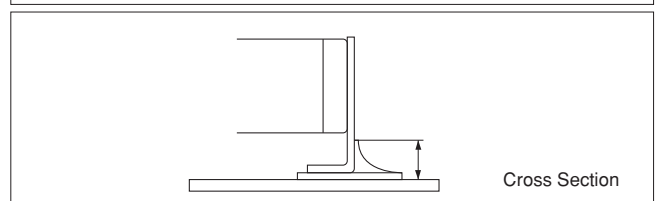
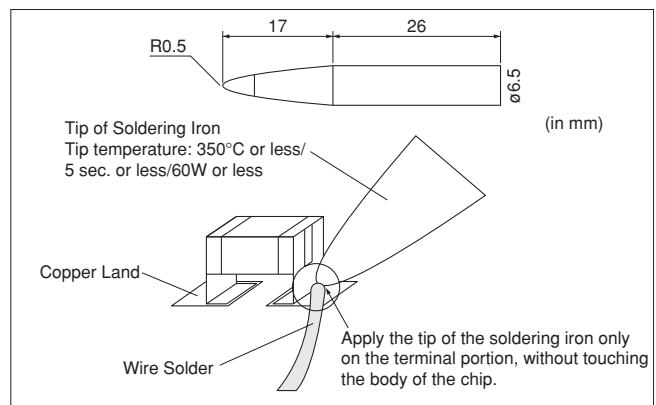
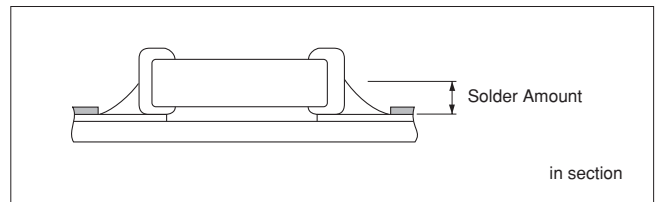

Continued on the following page. ☐

GCM Series
 GCJ Series
 GCD Series
 GCE Series
 GCG Series
 GC3 Series
 KCM Series
 KC3 Series
 ⚠Caution

⚠Caution

☐ Continued from the preceding page.

4-4. Leaded Component Insertion

1. If the PCB is flexed when leaded components (such as transformers and ICs) are being mounted, chips may crack and solder joints may break.

Before mounting leaded components, support the PCB using backup pins or special jigs to prevent warping.

5. Washing

Excessive ultrasonic oscillation during cleaning can cause the PCBs to resonate, resulting in cracked chips or broken solder joints. Take note not to vibrate PCBs.

6. Electrical Test on Printed Circuit Board

1. Confirm position of the support pin or specific jig, when inspecting the electrical performance of a capacitor after mounting on the printed circuit board.

- 1-1. Avoid bending the printed circuit board by the pressure of a test pin, etc.

The thrusting force of the test probe can flex the PCB, resulting in cracked chips or open solder joints.

Provide support pins on the back side of the PCB to prevent warping or flexing.

- 1-2. Avoid vibration of the board by shock when a test pin contacts a printed circuit board.

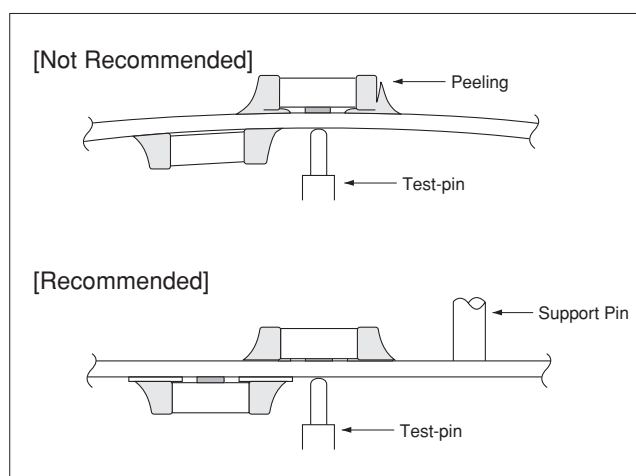

7. Printed Circuit Board Cropping

1. After mounting a capacitor on a printed circuit board, do not apply any stress to the capacitor that is caused by bending or twisting the board.

- 1-1. In cropping the board, the stress as shown at right may cause the capacitor to crack.

Avoid this type of stress to a capacitor.

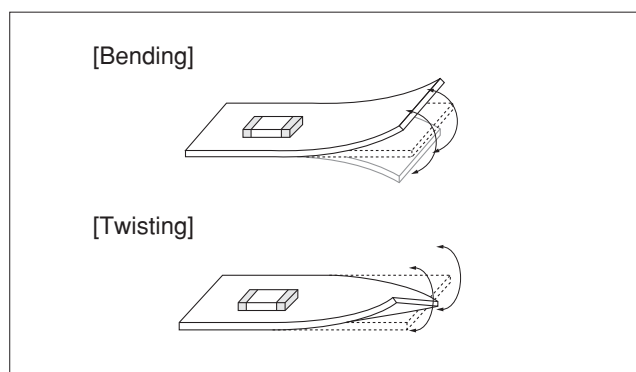

Continued on the following page. ☐

⚠Caution

☐ Continued from the preceding page.

2. Check the cropping method for the printed circuit board in advance.

2-1. Printed circuit board cropping shall be carried out by using a jig or an apparatus to prevent the mechanical stress that can occur to the board.

(1) Example of a suitable jig

Recommended example: the board should be pushed as close to the cropping jig as possible and from the back side of the board in order to minimize the compressive stress applied to the capacitor.

Not recommended example: when the board is pushed at a point far from the cropping jig and from the front side of board as below, the capacitor may form a crack caused by the tensile stress applied.

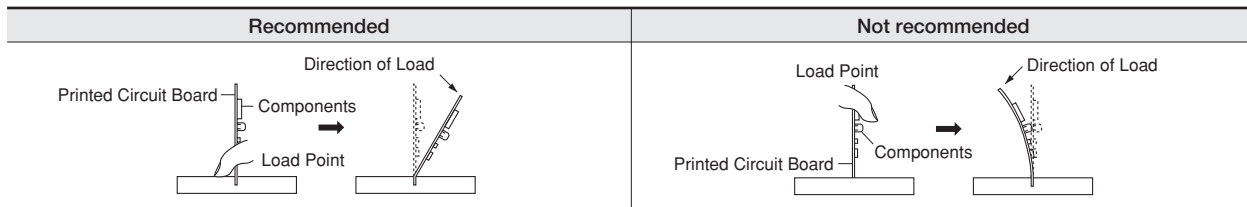
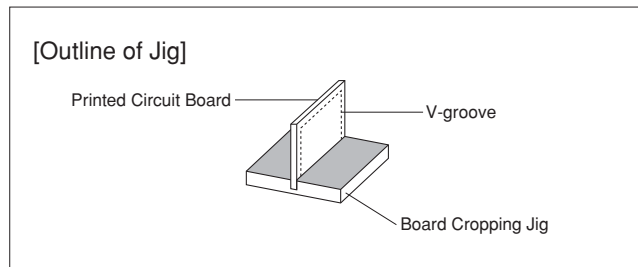

(2) Example of a suitable machine

An outline of a printed circuit board cropping machine is shown as follows. Along the lines with the V-grooves on the printed circuit board, the top and bottom blades are aligned to one another when cropping the board.

The misalignment of the position between top and bottom blades may cause the capacitor to crack.

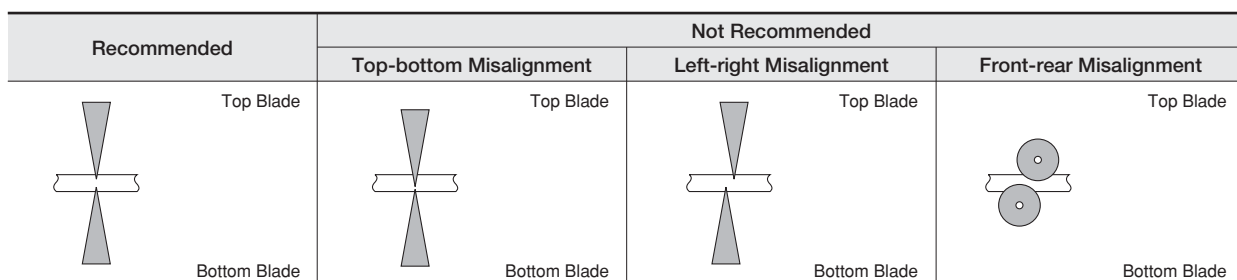
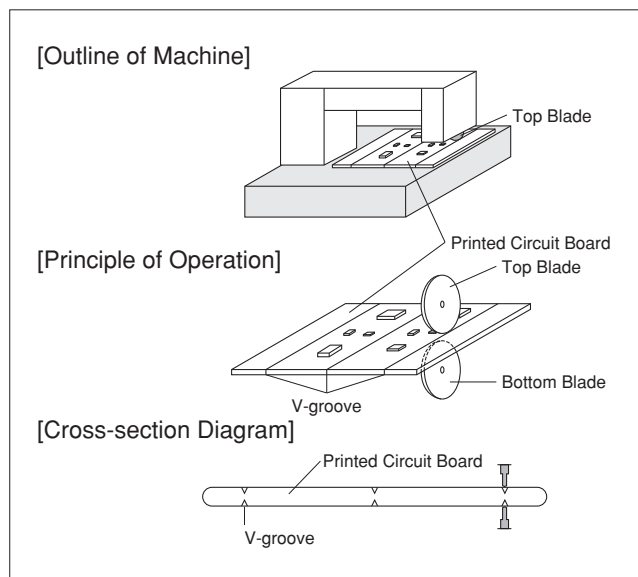

Continued on the following page. ☐

GCM Series

GCJ Series

GCD Series

GCE Series

GCG Series

GC3 Series

KCM Series

KC3 Series

⚠Caution

⚠Caution

☐ Continued from the preceding page.

<Applicable to GCG Series>

8. Selection of Conductive Adhesive, Mounting Process, and Bonding Strength

The acquired bonding strength may change greatly depending on the conductive adhesive to be used.

Be sure to confirm if the desired performance can be acquired in the assumed mounting process with the conductive adhesive to be used.

9. Moisture Proof Process

In order to prevent the occurrence of migration, perform a moisture proof process, such as applying a resin coating or enclosing with a dry inert gas.

10. Application

This product is for conductive adhesive mounting. When performing solder mounting, contact Murata in advance.

■ Other

1. Under Operation of Equipment

- 1-1. Do not touch a capacitor directly with bare hands during operation in order to avoid the danger of an electric shock.
- 1-2. Do not allow the terminals of a capacitor to come in contact with any conductive objects (short-circuit). Do not expose a capacitor to a conductive liquid, including any acid or alkali solutions.
- 1-3. Confirm the environment in which the equipment will operate is under the specified conditions. Do not use the equipment under the following environments.
 - (1) Being splattered with water or oil.
 - (2) Being exposed to direct sunlight.
 - (3) Being exposed to ozone, ultraviolet rays, or radiation.
 - (4) Being exposed to toxic gas (e.g., hydrogen sulfide, sulfur dioxide, chlorine, ammonia gas, etc.)
 - (5) Any vibrations or mechanical shocks exceeding the specified limits.
 - (6) Moisture condensing environments.
- 1-4. Use damp proof countermeasures if using under any conditions that can cause condensation.

2. Other

- 2-1. In an Emergency
 - (1) If the equipment should generate smoke, fire, or smell, immediately turn off or unplug the equipment. If the equipment is not turned off or unplugged, the hazards may be worsened by supplying continuous power.
 - (2) In this type of situation, do not allow face and hands to come in contact with the capacitor or burns may be caused by the capacitor's high temperature.

2-2. Disposal of Waste

When capacitors are disposed of, they must be burned or buried by an industrial waste vendor with the appropriate licenses.

2-3. Circuit Design

- (1) Addition of Fail Safe Function
Be sure to add a fail safe function to the finished product to prevent secondary accidents, in the case where an abnormality or discrepancy occurs in the product.
- (2) Capacitors used to prevent electromagnetic interference in the primary AC side circuit, or as a connection/insulation, must be a safety standard certified product, or satisfy the contents stipulated in the Electrical Appliance and Material Safety Law.
- (3) The GC3, GCD, GCE, GCG, GCJ, GCM, KC3, and KCM series are not safety standard certified products.

2-4. Remarks

Failure to follow the cautions may result, worst case, in a short circuit and smoking when the product is used.

The above notices are for standard applications and conditions. Contact us when the products are used in special mounting conditions. Select optimum conditions for operation as they determine the reliability of the product after assembly. The data herein are given in typical values, not guaranteed ratings.

Notice

Rating

1. Operating Temperature

1. The operating temperature limit depends on the capacitor.

1-1. Do not apply temperatures exceeding the upper operating temperature.

It is necessary to select a capacitor with a suitable rated temperature that will cover the operating temperature range.

It is also necessary to consider the temperature distribution in equipment and the seasonal temperature variable factor.

1-2. Consider the self-heating factor of the capacitor.

The surface temperature of the capacitor shall be the upper operating temperature or less when including the self-heating factors.

2. Atmosphere Surroundings (gaseous and liquid)

1. Restriction on the operating environment of capacitors.

1-1. Capacitors, when used in the above, unsuitable,

operating environments may deteriorate due to the corrosion of the terminations and the penetration of moisture into the capacitor.

1-2. The same phenomenon as the above may occur when the electrodes or terminals of the capacitor are subject to moisture condensation.

1-3. The deterioration of characteristics and insulation resistance due to the oxidization or corrosion of terminal electrodes may result in breakdown when the capacitor is exposed to corrosive or volatile gases or solvents for long periods of time.

3. Piezo-electric Phenomenon

1. When using high dielectric constant type capacitors in AC or pulse circuits, the capacitor itself vibrates at specific frequencies and noise may be generated. Moreover, when the mechanical vibration or shock is added to the capacitor, noise may occur.

Soldering and Mounting

1. PCB Design

1. Notice for Pattern Forms



1-1. Unlike leaded components, chip components are susceptible to flexing stresses since they are mounted directly on the substrate.

They are also more sensitive to mechanical and thermal stresses than leaded components.

Excess solder fillet height can multiply these stresses and cause chip cracking. When designing substrates, take land patterns and dimensions into consideration to eliminate the possibility of excess solder fillet height.

1-2. There is a possibility of chip cracking caused by PCB expansion/contraction with heat, because stress on a chip is different depending on PCB material and structure. Especially metal PCB such as alumina has a greater risk of chip crack because of the large difference in thermal expansion coefficient. In case of a chip below 0402 size, there is also the same possibility of cracking with a single-layered glass epoxy board.

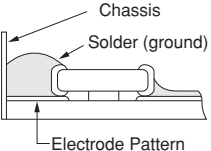
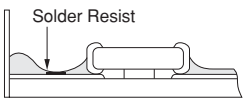
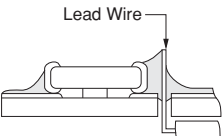
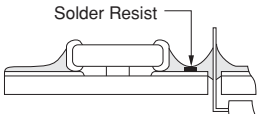
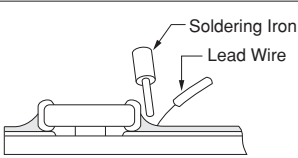
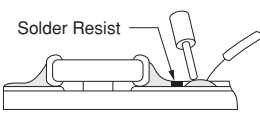
Pattern Forms

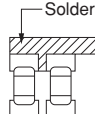
	Prohibited	Correct
Placing Close to Chassis		
Placing of Chip Components and Leaded Components		
Placing of Leaded Components after Chip Component		
Lateral Mounting		

Continued on the following page. ↗

Notice

☐ Continued from the preceding page.

2. Land Dimensions

2-1. Chip capacitors can be cracked due to the stress of PCB bending, etc. if the land area is larger than needed and has an excess amount of solder. Please refer to the land dimensions in table 1 for flow soldering, table 2 for reflow soldering. Please confirm the suitable land dimension by evaluating of the actual SET / PCB.

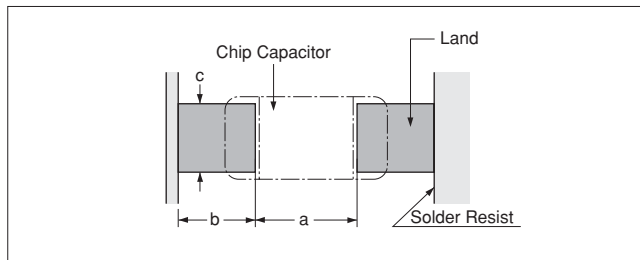

Table 1 Flow Soldering Method

Part Number	Dimensions	Chip (L×W)	a	b	c
GC3/GCD/GCM/GCJ18 (Rated Voltage: above 250VDC (for GCJ18 alone))		1.6×0.8	0.6 to 1.0	0.8 to 0.9	0.6 to 0.8
GC3/GCD/GCM/GCJ21 (Rated Voltage: above 250VDC (for GCJ21 alone))		2.0×1.25	1.0 to 1.2	0.9 to 1.0	0.8 to 1.1
GC3/GCD/GCM/GCJ31 (Rated Voltage: above 250VDC (for GCJ31 alone))		3.2×1.6	2.2 to 2.6	1.0 to 1.1	1.0 to 1.4

Flow soldering can only be used for products with a chip size of 3.2x1.6mm or less.

(in mm)

Table 2 Reflow Soldering Method

Part Number	Dimensions	Chip (L×W)	a	b	c
GC3/GCD/GCE/GCJ/GCM03		0.6×0.3	0.2 to 0.3	0.2 to 0.35	0.2 to 0.4
GC3/GCD/GCE/GCJ/GCM15		1.0×0.5	0.3 to 0.5	0.35 to 0.45	0.4 to 0.6
GC3/GCD/GCE/GCJ/GCM18		1.6×0.8	0.6 to 0.8	0.6 to 0.7	0.6 to 0.8
GC3/GCD/GCE/GCJ/GCM21		2.0×1.25	1.0 to 1.2	0.6 to 0.7	0.8 to 1.1
GC3/GCD/GCE/GCJ/GCM31		3.2×1.6	2.2 to 2.4	0.8 to 0.9	1.0 to 1.4
GC3/GCD/GCE/GCJ/GCM32		3.2×2.5	2.0 to 2.4	1.0 to 1.2	1.8 to 2.3
GC3/GCD/GCE/GCJ/GCM43		4.5×3.2	3.0 to 3.5	1.2 to 1.4	2.3 to 3.0
GC3/GCD/GCE/GCJ/GCM55		5.7×5.0	4.0 to 4.6	1.4 to 1.6	3.5 to 4.8

(in mm)

<Applicable to Part Number KC3/KCM>

Part Number	Dimensions	Chip (L×W)	a	b	c
KC3/KCM55		5.7×5.0	2.6	2.7	5.6

(in mm)

2. Adhesive Application

1. Thin or insufficient adhesive can cause the chips to loosen or become disconnected during flow soldering. The amount of adhesive must be more than dimension c, shown in the drawing at right, to obtain the correct bonding strength. The chip's electrode thickness and land thickness must also be taken into consideration.

2. Low viscosity adhesive can cause chips to slip after mounting. The adhesive must have a viscosity of 5000Pa · s (500ps) min. (at 25°C).

3. Adhesive Coverage

Size (L×W)	Adhesive Coverage*
1.6×0.8	0.05mg min.
2.0×1.25	0.1mg min.
3.2×1.6	0.15mg min.

*Nominal Value

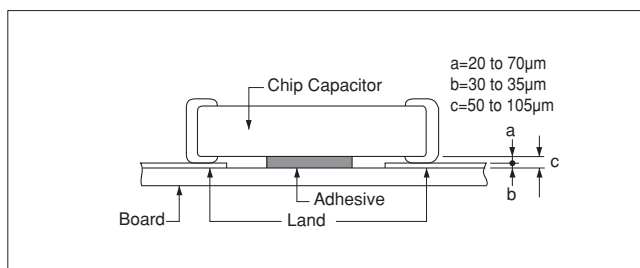

Notice

☐ Continued from the preceding page.

3. Adhesive Curing

1. Insufficient curing of the adhesive can cause chips to disconnect during flow soldering and causes deterioration in the insulation resistance between the outer electrodes due to moisture absorption.

Control curing temperature and time in order to prevent insufficient hardening.

4. Flux Application

1. An excessive amount of flux generates a large quantity of flux gas, which can cause a deterioration of solder ability, so apply flux thinly and evenly throughout. (A foaming system is generally used for flow soldering.)
2. Flux containing too high a percentage of halide may cause corrosion of the outer electrodes unless there is sufficient cleaning. Use flux with a halide content of 0.1% max.

5. Flow Soldering

- Set temperature and time to ensure that leaching of the outer electrode does not exceed 25% of the chip end area as a single chip (full length of the edge A-B-C-D shown at right) and 25% of the length A-B shown as mounted on substrate.

3. Do not use strong acidic flux.
4. Do not use water-soluble flux.*
(*Water-soluble flux can be defined as non-rosin type flux including wash-type flux and non-wash-type flux.)

[As a Single Chip]

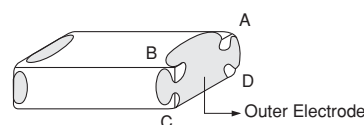

[As Mounted on Substrate]

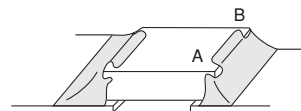

6. Washing

1. Please evaluate the capacitor using actual cleaning equipment and conditions to confirm the quality, and select the solvent for cleaning.
2. Unsuitable cleaning solvent may leave residual flux or other foreign substances, causing deterioration of electrical characteristics and the reliability of the capacitors.

3. Select the proper cleaning conditions.
3-1. Improper cleaning conditions (excessive or insufficient) may result in deterioration of the performance of the capacitors.

GCM Series

GCJ Series

GCD Series

GCE Series

GCG Series

GC3 Series

KCM Series

KC3 Series

Notice

Notice

☐ Continued from the preceding page.

7. Coating

1. A crack may be caused in the capacitor due to the stress of the thermal contraction of the resin during curing process.

The stress is affected by the amount of resin and curing contraction.

Select a resin with low curing contraction.

The difference in the thermal expansion coefficient between a coating resin or a molding resin and the capacitor may cause the destruction and deterioration of the capacitor such as a crack or peeling, and lead to the deterioration of insulation resistance or dielectric breakdown.

Select a resin for which the thermal expansion coefficient is as close to that of the capacitor as possible.

A silicone resin can be used as an under-coating to buffer against the stress.

2. Select a resin that is less hygroscopic.

Using hygroscopic resins under high humidity conditions may cause the deterioration of the insulation resistance of a capacitor.

An epoxy resin can be used as a less hygroscopic resin.

■ Other

1. Transportation

1. The performance of a capacitor may be affected by the conditions during transportation.

1-1. The capacitors shall be protected against excessive temperature, humidity, and mechanical force during transportation.

(1) Climatic condition

- low air temperature: -40°C
- change of temperature air/air: -25°C/+25°C
- low air pressure: 30 kPa
- change of air pressure: 6 kPa/min.

(2) Mechanical condition

Transportation shall be done in such a way that the boxes are not deformed and forces are not directly passed on to the inner packaging.

1-2. Do not apply excessive vibration, shock, or pressure to the capacitor.

(1) When excessive mechanical shock or pressure is applied to a capacitor, chipping or cracking may occur in the ceramic body of the capacitor.

(2) When the sharp edge of an air driver, a soldering iron, tweezers, a chassis, etc. impacts strongly on the surface of the capacitor, the capacitor may crack and short-circuit.

1-3. Do not use a capacitor to which excessive shock was applied by dropping, etc.

A capacitor dropped accidentally during processing may be damaged.

2. Characteristics Evaluation in the Actual System

1. Evaluate the capacitor in the actual system, to confirm that there is no problem with the performance and specification values in a finished product before using.

2. Since a voltage dependency and temperature dependency exists in the capacitance of high dielectric type ceramic capacitors, the capacitance may change depending on the operating conditions in the actual system. Therefore, be sure to evaluate the various characteristics, such as the leakage current and noise absorptivity, which will affect the capacitance value of the capacitor.

3. In addition, voltages exceeding the predetermined surge may be applied to the capacitor by the inductance in the actual system. Evaluate the surge resistance in the actual system as required.

Design assistant tool: SimSurfing SimSurfing



MLCC is now available !

Design assistant tool "SimSurfing" has been updated and you can now find and view any kind of characteristics of MLCCs.

Available function for MLCCs:

- ① Products search
- ② View frequency characteristics (S parameters, Z, R, X, Q, DF, L, C)
DC bias can be applied to available part number.
- ③ DC voltage bias characteristics (absolute capacitance/change rate)
- ④ Temperature characteristics (absolute capacitance/change rate)
- ⑤ AC voltage bias characteristics (absolute capacitance/change rate)
- ⑥ Download SPICE netlist/ S parameter

1 Select the Products

- (1) By part number
- (2) By specification

2 View characteristics

By clicking buttons in this area with part number selected, you can view any electrical characteristics chart.

3 Data download

You can download SPICE netlist and S parameter files (S2P)

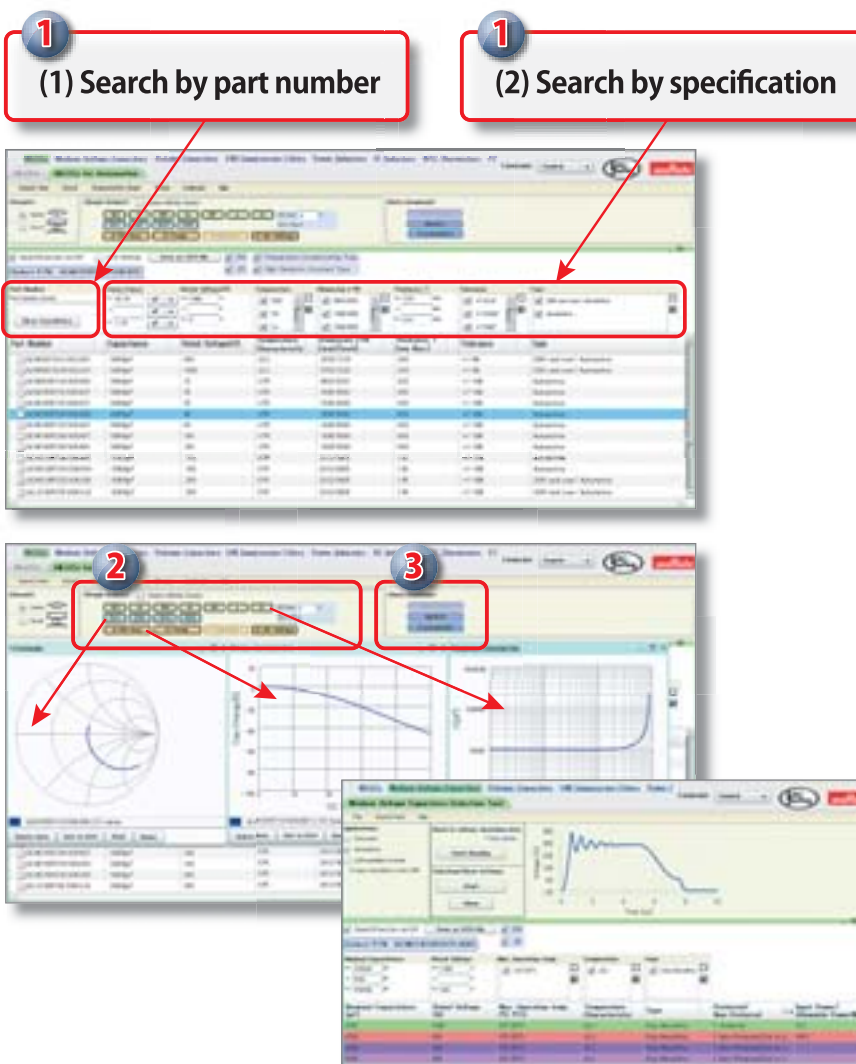

Added the capacitor finder tool for middle and high voltage capacitor which are capable for specified voltage waveform.

These images are captured at May/2013. Be sure that this software will be updated frequently.

<http://ds.murata.com/software/simsurfing/en-us/mlcc/>

EMICON-FUN!

Please check Murata's newsletter!
 You can learn about electric parts with fun.
http://www.murata.com/products/emicon_fun/

EMICON-FUN! disseminated widely from basics (principles, characteristics, mounting, etc.) of capacitors, inductors and EMI suppression filters to information can practically be used.
 Updated information is also distributed via the mail magazine.

You can register from the Products page on Murata Manufacturing website.
<http://www.murata.com/products/>



← This banner is the entrance of register form

Capacitor Website Introduction

The website and search engine of ceramic capacitors has been drastically renewed.



- ▶ **Convenient Search** The type of searches has been increased to respond to various ways of searching. The products you are searching for can easily be found from about 40,000 part numbers! The frequency of revisions and discontinuance has been increased to provide the latest information at all times!
- ▶ **Substantial Technical Information**
 - Reference drawings (Specifications and Test Methods) can be downloaded in PDF format.
 - Graphs of the electrical characteristic data (Capacitance - Temperature characteristics / DC bias characteristics / AC voltage characteristics / Frequency characteristics) can be displayed.
 - Reliability test data can be downloaded.

1 Examples of Problem Solving
 Contents for Solving customers' problems.
 • Examples of Replacement (Video)
 • Proposal for Cost Reductions
 • Examples of Noise Countermeasures (Video) etc.

2 Industry Pickup
 Introducing the recommended series and the latest information on Murata for each industry.
 • Automobile
 • Smart Phones etc.

3 Advantages of Murata Capacitors
 We explain the unique benefits of Murata capacitors, our matchless quality, track record in the market, supply systems and development capability.

You can contact us and download catalogs from here.

1 Search by features
 Products can be searched by problems, shapes or mounting methods.

2 Search in the lineups
 Products can be searched by entire product lineup.

3 Search by specifications
 Products can be searched by capacitance, rated voltage or temperature characteristics.

4 Cross reference search
 Equivalent products of Murata can be searched by competitors' part numbers.

5 Search by part number
 Products can be searched by Murata's part numbers.

Design Tools

- **SimSurfing (WEB)**
 This is a web application to display characteristics charts of Murata products, and download the characteristics data.
- **S parameter**
- **Netlist (SPICE Model)**
- **Data Libraries (for Agilent ADS, for AWR Microwave Office®)**

Frequently Asked Questions (FAQ)
 This is a collection of questions asked by customers. The contents of problems can easily be searched by keywords with this search function.

Characteristics Data
 (Dimensions / Capacitance - Temperature Characteristics / DC Bias Characteristics / AC Voltage / Frequency Characteristics / Heat Generation by Ripple Currents, etc.)

Reliability Test Data
 Initial Characteristics / Board Bending Resistance / Humidity Resistance / High Temperature Load / Solderability, etc.

Safety Certificates by Series

List of ISO14001 Certified Plants

⚠Note:

1. Export Control

<For customers outside Japan>

No Murata products should be used or sold, through any channels, for use in the design, development, production, utilization, maintenance or operation of, or otherwise contribution to (1) any weapons (Weapons of Mass Destruction [nuclear, chemical or biological weapons or missiles] or conventional weapons) or (2) goods or systems specially designed or intended for military end-use or utilization by military end-users.

<For customers in Japan>

For products which are controlled items subject to the "Foreign Exchange and Foreign Trade Law" of Japan, the export license specified by the law is required for export.

2. Please contact our sales representatives or product engineers before using the products in this catalog for the applications listed below, which require especially high reliability for the prevention of defects which might directly damage a third party's life, body or property, or when one of our products is intended for use in applications other than those specified in this catalog.

- | | |
|-----------------------------|--|
| ① Aircraft equipment | ② Aerospace equipment |
| ③ Undersea equipment | ④ Power plant equipment |
| ⑤ Medical equipment | ⑥ Transportation equipment (vehicles, trains, ships, etc.) |
| ⑦ Traffic signal equipment | ⑧ Disaster prevention / crime prevention equipment |
| ⑨ Data-processing equipment | ⑩ Application of similar complexity and/or reliability requirements to the applications listed above |

3. Product specifications in this catalog are as of March 2013. They are subject to change or our products in it may be discontinued without advance notice. Please check with our sales representatives or product engineers before ordering. If there are any questions, please contact our sales representatives or product engineers.
4. Please read rating and ⚠CAUTION (for storage, operating, rating, soldering, mounting and handling) in this catalog to prevent smoking and/or burning, etc.
5. This catalog has only typical specifications. Therefore, please approve our product specifications or transact the approval sheet for product specifications before ordering.
6. Please note that unless otherwise specified, we shall assume no responsibility whatsoever for any conflict or dispute that may occur in connection with the effect of our and/or a third party's intellectual property rights and other related rights in consideration of your use of our products and/or information described or contained in our catalogs. In this connection, no representation shall be made to the effect that any third parties are authorized to use the rights mentioned above under licenses without our consent.
7. No ozone depleting substances (ODS) under the Montreal Protocol are used in our manufacturing process.