

**Features**

- ESD protection for high speed data lines to  
**IEC61000-4-2 ESD contact discharge typical 8KV, max 15KV**  
**IEC61000-4-2 ESD air discharge typical 15KV, max 25KV**
- Multilayer structure
- Surface mount
- Extremely low capacitance
- Very low leakage current
- Fast response time
- Bi-directional ESD protection
- Lead free solder termination
- The best ESD protection for high frequency, low voltage applications

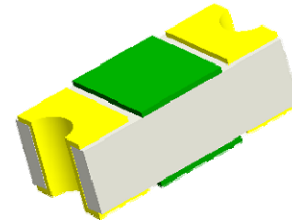

**Application**

- High Definition Multi-Media Interface (HDMI)
- Digital Visual Interface (DVI)
- Display Port Interface
- Unified Display Interface (UDI)
- MDDI Ports
- Gigabit Ethernet
- USB2.0 and IEEE1394 interface

Caution: This component is designed for signal line protection only, not intended to be used under bias, not for application with a power line.

**Electrical Characteristics**

Electrical Characteristics						
Parameter	Symbol	Conditions	Min	Typ	Max	Units
Continuous operating voltage	$V_{DC}$	---	---	---	24	V
Trigger voltage	$V_T$	IEC61000-4-2 8KV contact discharge	---	500	---	V
Clamping voltage	$V_C$	IEC61000-4-2 8KV contact discharge	---	36	---	V
Leakage current	$I_L$	24V $V_{DC}$	---	0.20	10	nA
Capacitance	$C_P$	$V_R = 0V, f = 1MHz$	---	0.15	0.3	pF
Operating Temperature	---	---	-40	---	90	°C
Storage Temperature	---	---	-55	---	150	°C
ESD pulse withstand	Pulses	IEC61000-4-2 8KV contact discharge	2000	---	---	---

Notes:

1, Trigger and clamping voltage measure per IEC 61000-4-2, 8KV direct discharge method

**Typical PESD clamping for +8KV pulse per IEC61000-4-2**

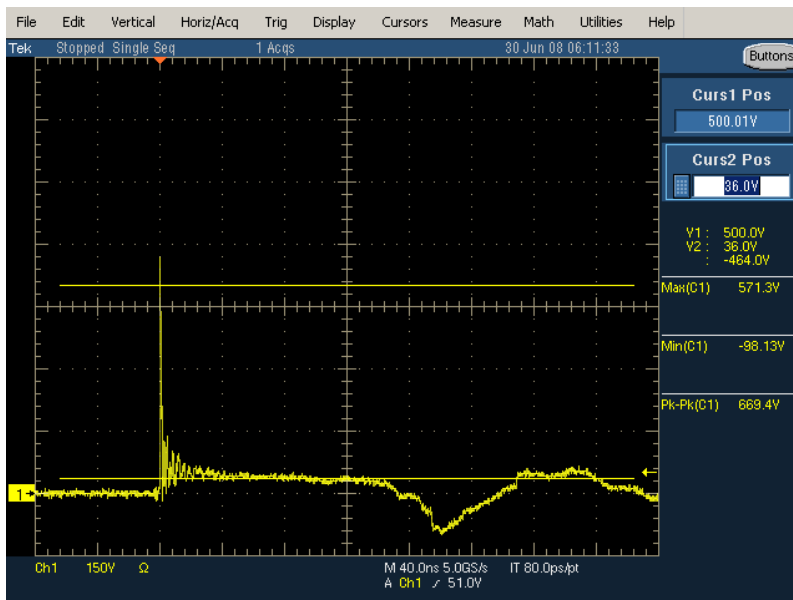

**Design Recommendations for USB2.0**

For USB2.0 port

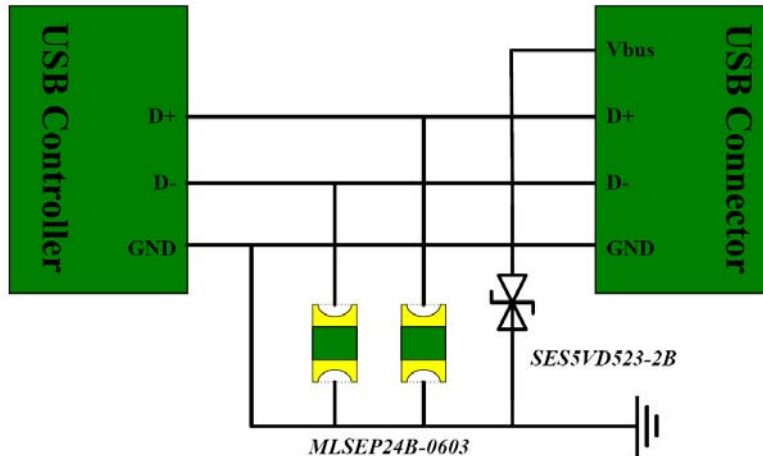

**Design Recommendations for Antenna**

For antenna line

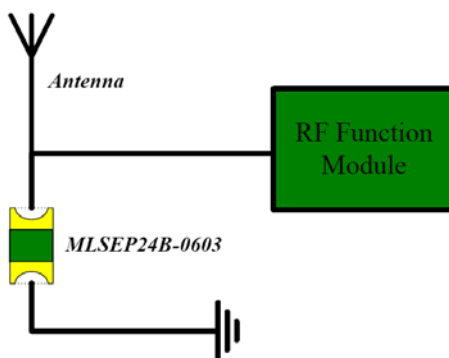

**Part Numbering**

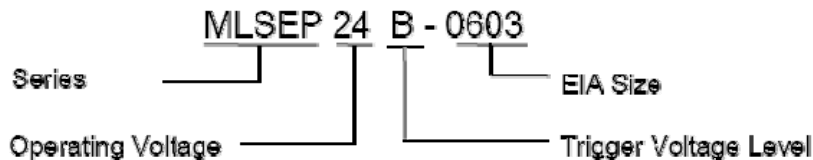

**Environmental Specifications**

Operation temperature: -40~90°C

Moisture Resistance, Steady state: MIL-STD-833, Method 1004.7, 85% RH, 85°C, 1000hrs

Thermal Shock: MIL-STD-202, Method 107G, -55°C to 150°C, 30 min cycle, 10 cycles.

Vibration: MIL-STD-202F, Method 201A, (10 to 55 to 10HZ, 1 min. cycle, 2hrs each in X-Y-Z)

Chemical Resistance: ASTM D-543, 4hrs @40°C, 3 solutions (H<sub>2</sub>O, detergent solution, deluxer)

Solder leach resistance and terminal adhesion: Per EIA-576 test

**Product Dimensions (mm)**

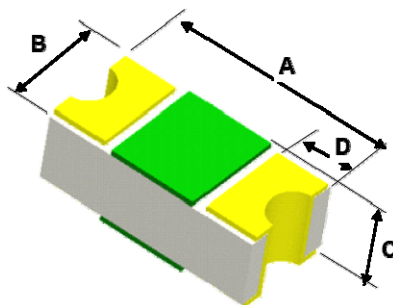

Length A		Width B		Height C		Terminal width D		Unit
Min	Max	Min	Max	Min	Max	Min	Max	
1.50	1.70	0.70	0.90	0.33	0.43	0.40	0.50	mm

**Recommended PAD Layout**

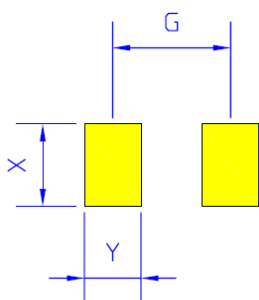

X		Y		G		Unit
Min	Max	Min	Max	Min	Max	
0.90	1.00	0.60	0.70	1.30	1.40	mm

**Solder Reflow Recommendation**

**PESD Solder Profile**

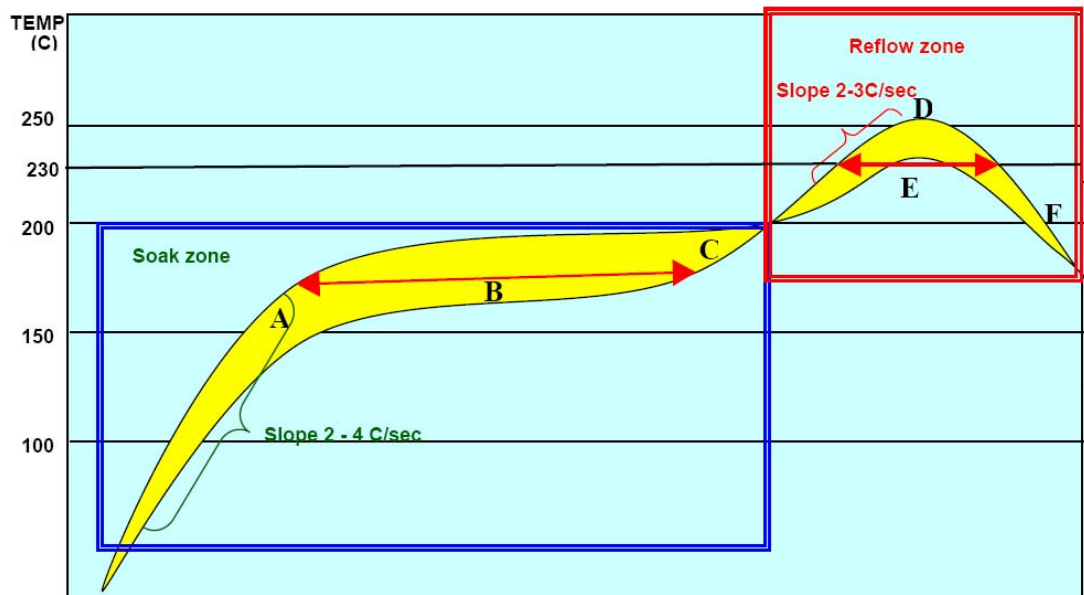

Item	Process	Description	Reach Temp.	Time or Rate
A	Soak Start	From ambient to soak temperature and soak start	150°C - 180°C	2°C - 4°C / sec
B	Soak time	Soak time	---	60s - 120s
C	Soak end	Soak end	180°C - 200°C	---
D	Peak Temp.	From soak temperature to Peak temperature	260°C	2°C - 3°C / sec
E	Time above	Main heating time	230°C - 260°C	40s - 60s
F	Cooling	From main heating temperature to 100°C	100°C	Max. 4°C / sec

**Notes:**

- 1\* Peak temperature can be high to 260°C, and the recommendation time is as below
  - at 230°C                    40s ~ 60s
  - at 240°C                    30s ~ 40s
  - at 260°C                    5s ~ 10s

2\* Recommended reflow methods: IR, Vapor phase oven, hot air oven, wave solder.

3\* Devices can be cleaned using standard industry methods and solvents.

4\* Component can withstand 270°C 10 sec.

5\* If reflow temperatures exceed the recommended profile, devices may not meet the performance requirements.

**Package Information**

Tape & Reel: 5000pcs per reel.