

# MMBZ52xxBLT1G Series, SZMMBZ52xxBLT1G Series

## Zener Voltage Regulators

### 225 mW SOT-23 Surface Mount

This series of Zener diodes is offered in the convenient, surface mount plastic SOT-23 package. These devices are designed to provide voltage regulation with minimum space requirement. They are well suited for applications such as cellular phones, hand held portables, and high density PC boards.

#### Features

- 225 mW Rating on FR-4 or FR-5 Board
- Zener Voltage Range – 2.4 V to 91 V
- Package Designed for Optimal Automated Board Assembly
- Small Package Size for High Density Applications
- ESD Rating of Class 3 (> 16 KV) per Human Body Model
- SZ Prefix for Automotive and Other Applications Requiring Unique Site and Control Change Requirements; AEC-Q101 Qualified and PPAP Capable
- Pb-Free Packages are Available\*

#### Mechanical Characteristics

**CASE:** Void-free, transfer-molded, thermosetting plastic case

**FINISH:** Corrosion resistant finish, easily solderable

**MAXIMUM CASE TEMPERATURE FOR SOLDERING PURPOSES:**

260°C for 10 Seconds

**POLARITY:** Cathode indicated by polarity band

**FLAMMABILITY RATING:** UL 94 V-0

#### MAXIMUM RATINGS

Rating	Symbol	Max	Units
Total Power Dissipation on FR-5 Board, (Note 1) @ $T_A = 25^\circ\text{C}$ Derated above $25^\circ\text{C}$	$P_D$	225 1.8	mW mW/ $^\circ\text{C}$
Thermal Resistance, Junction-to-Ambient	$R_{\theta JA}$	556	$^\circ\text{C}/\text{W}$
Total Power Dissipation on Alumina Substrate, (Note 2) @ $T_A = 25^\circ\text{C}$ Derated above $25^\circ\text{C}$	$P_D$	300 2.4	mW mW/ $^\circ\text{C}$
Thermal Resistance, Junction-to-Ambient	$R_{\theta JA}$	417	$^\circ\text{C}/\text{W}$
Junction and Storage Temperature Range	$T_J, T_{stg}$	-65 to +150	$^\circ\text{C}$

Stresses exceeding Maximum Ratings may damage the device. Maximum Ratings are stress ratings only. Functional operation above the Recommended Operating Conditions is not implied. Extended exposure to stresses above the Recommended Operating Conditions may affect device reliability.

1. FR-5 = 1.0 X 0.75 X 0.62 in.
2. Alumina = 0.4 X 0.3 X 0.024 in, 99.5% alumina.

\*For additional information on our Pb-Free strategy and soldering details, please download the ON Semiconductor Soldering and Mounting Techniques Reference Manual, SOLDERRM/D.



ON Semiconductor®

<http://onsemi.com>

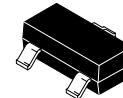

SOT-23  
CASE 318  
STYLE 8

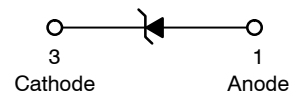

#### MARKING DIAGRAM

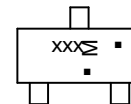

- xxx = Specific Device Code
- M = Date Code
- = Pb-Free Package

(Note: Microdot may be in either location)

#### ORDERING INFORMATION

Device	Package	Shipping†
MMBZ52xxBLT1G	SOT-23 (Pb-Free)	3,000 / Tape & Reel
SZMMBZ52xxBLT1G	SOT-23 (Pb-Free)	3,000 / Tape & Reel
MMBZ52xxBLT3G	SOT-23 (Pb-Free)	10,000 / Tape & Reel
SZMMBZ52xxBLT3G	SOT-23 (Pb-Free)	10,000 / Tape & Reel

†For information on tape and reel specifications, including part orientation and tape sizes, please refer to our Tape and Reel Packaging Specifications Brochure, BRD8011/D.

#### DEVICE MARKING INFORMATION

See specific marking information in the device marking column of the Electrical Characteristics table on page 3 of this data sheet.

## MMBZ52xxBLT1G Series, SZMMBZ52xxBLT1G Series

### ELECTRICAL CHARACTERISTICS

(Pinout: 1-Anode, 2-No Connection, 3-Cathode) ( $T_A = 25^\circ\text{C}$  unless otherwise noted,  $V_F = 0.95\text{ V Max. @ } I_F = 10\text{ mA}$ )

Symbol	Parameter
$V_Z$	Reverse Zener Voltage @ $I_{ZT}$
$I_{ZT}$	Reverse Current
$Z_{ZT}$	Maximum Zener Impedance @ $I_{ZT}$
$I_{ZK}$	Reverse Current
$Z_{ZK}$	Maximum Zener Impedance @ $I_{ZK}$
$I_R$	Reverse Leakage Current @ $V_R$
$V_R$	Reverse Voltage
$I_F$	Forward Current
$V_F$	Forward Voltage @ $I_F$

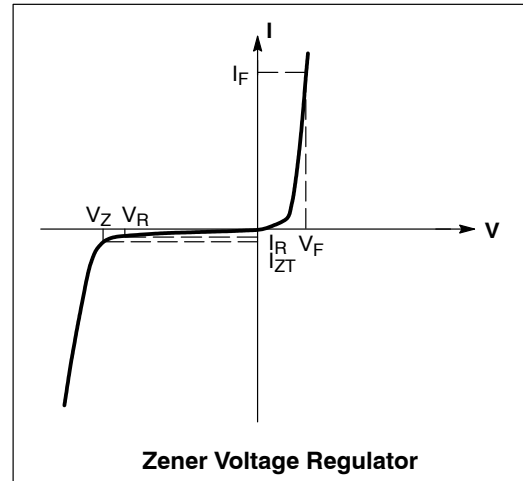

## MMBZ52xxBLT1G Series, SZMMBZ52xxBLT1G Series

**ELECTRICAL CHARACTERISTICS** (Pinout: 1-Anode, 2-NC, 3-Cathode) ( $V_F = 0.9\text{ V Max @ }I_F = 10\text{ mA}$  for all types.)

Device*	Device Marking	Zener Voltage (Note 3)				Zener Impedance			Leakage Current	
		V <sub>Z</sub> (Volts)			@ I <sub>ZT</sub>	Z <sub>ZT</sub> @ I <sub>ZT</sub>	Z <sub>ZK</sub> @ I <sub>ZK</sub>		I <sub>R</sub> @ V <sub>R</sub>	
		Min	Nom	Max	mA	Ω	Ω	mA	μA	Volts
MMBZ5221BLT1G	18A	2.28	2.4	2.52	20	30	1200	0.25	100	1
MMBZ5222BLT1G	18B	2.37	2.5	2.63	20	30	1250	0.25	100	1
MMBZ5223BLT1G	18C	2.56	2.7	2.84	20	30	1300	0.25	75	1
MMBZ5224BLT1G	18D	2.66	2.8	2.94	20	30	1400	0.25	75	1
MMBZ5225BLT1G	18E	2.85	3	3.15	20	29	1600	0.25	50	1
MMBZ5226BLT1G	8A	3.13	3.3	3.47	20	28	1600	0.25	25	1
MMBZ5227BLT1G	8B	3.42	3.6	3.78	20	24	1700	0.25	15	1
MMBZ5228BLT1G	8C	3.70	3.9	4.10	20	23	1900	0.25	10	1
MMBZ5229BLT1G	8D	4.08	4.3	4.52	20	22	2000	0.25	5	1
MMBZ5230BLT1G	8E	4.46	4.7	4.94	20	19	1900	0.25	5	2
MMBZ5231BLT1G/T3G	8F	4.84	5.1	5.36	20	17	1600	0.25	5	2
MMBZ5232BLT1G/T3G	8G	5.32	5.6	5.88	20	11	1600	0.25	5	3
MMBZ5233BLT1G	8H	5.70	6	6.30	20	7	1600	0.25	5	3.5
MMBZ5234BLT1G/T3G	8J	5.89	6.2	6.51	20	7	1000	0.25	5	4
MMBZ5235BLT1G	8K	6.46	6.8	7.14	20	5	750	0.25	3	5
MMBZ5236BLT1G	8L	7.12	7.5	7.88	20	6	500	0.25	3	6
MMBZ5237BLT1G	8M	7.79	8.2	8.61	20	8	500	0.25	3	6.5
MMBZ5238BLT1G	8N	8.26	8.7	9.14	20	8	600	0.25	3	6.5
MMBZ5239BLT1G	8P	8.64	9.1	9.56	20	10	600	0.25	3	7
MMBZ5240BLT1G	8Q	9.50	10	10.50	20	17	600	0.25	3	8
MMBZ5241BLT1G/T3G	8R	10.4	11	11.55	20	22	600	0.25	2	8.4
MMBZ5242BLT1G/T3G	8S	11.40	12	12.60	20	30	600	0.25	1	9.1
MMBZ5243BLT1G	8T	12.35	13	13.65	9.5	13	600	0.25	0.5	9.9
MMBZ5244BLT1G	8U	13.30	14	14.70	9	15	600	0.25	0.1	10
MMBZ5245BLT1G	8V	14.25	15	15.75	8.5	16	600	0.25	0.1	11
MMBZ5246BLT1G	8W	15.20	16	16.80	7.8	17	600	0.25	0.1	12
MMBZ5247BLT1G/T3G	8X	16.15	17	17.85	7.4	19	600	0.25	0.1	13
MMBZ5248BLT1G/T3G	8Y	17.10	18	18.90	7	21	600	0.25	0.1	14
MMBZ5249BLT1G	8Z	18.05	19	19.95	6.6	23	600	0.25	0.1	14
MMBZ5250BLT1G/T3G	81A	19.00	20	21.00	6.2	25	600	0.25	0.1	15
MMBZ5251BLT1G	81B	20.90	22	23.10	5.6	29	600	0.25	0.1	17
MMBZ5252BLT1G	81C	22.80	24	25.20	5.2	33	600	0.25	0.1	18
MMBZ5253BLT1G	81D	23.75	25	26.25	5	35	600	0.25	0.1	19
MMBZ5254BLT1G	81E	25.65	27	28.35	4.6	41	600	0.25	0.1	21
MMBZ5255BLT1G	81F	26.60	28	29.40	4.5	44	600	0.25	0.1	21
MMBZ5256BLT1G	81G	28.50	30	31.50	4.2	49	600	0.25	0.1	23
MMBZ5257BLT1G/T3G	81H	31.35	33	34.65	3.8	58	700	0.25	0.1	25
MMBZ5258BLT1G	81J	34.20	36	37.80	3.4	70	700	0.25	0.1	27
MMBZ5259BLT1G	81K	37.05	39	40.95	3.2	80	800	0.25	0.1	30
MMBZ5260BLT1G	81L	40.85	43	45.15	3	93	900	0.25	0.1	33
MMBZ5261BLT1G/T3G	81M	44.65	47	49.35	2.7	105	1000	0.25	0.1	36
MMBZ5262BLT1G	81N	48.45	51	53.55	2.5	125	1100	0.25	0.1	39
MMBZ5263BLT1G	81P	53.20	56	58.80	2.2	150	1300	0.25	0.1	43
MMBZ5264BLT1G	81Q	57.00	60	63.00	2.1	170	1400	0.25	0.1	46
MMBZ5265BLT1G	81R	58.90	62	65.10	2	185	1400	0.25	0.1	47
MMBZ5266BLT1G	81S	64.60	68	71.40	1.8	230	1600	0.25	0.1	52
MMBZ5267BLT1G	81T	71.25	75	78.75	1.7	270	1700	0.25	0.1	56
MMBZ5268BLT1G	81U	77.90	82	86.10	1.5	330	2000	0.25	0.1	62
MMBZ5270BLT1G	81W	86.45	91	95.55	1.4	400	2300	0.25	0.1	69

3. Zener voltage is measured with a pulse test current I<sub>Z</sub> at an ambient temperature of 25°C

NOTE: MMBZ5233BLT1G, MMBZ5246BLT1G, MMBZ5251BLT1G, and MMBZ5252BLT1G Not Available in 10,000/Tape & Reel.

\*Include SZ-prefix devices where applicable.

# MMBZ52xxBLT1G Series, SZMMBZ52xxBLT1G Series

## TYPICAL CHARACTERISTICS

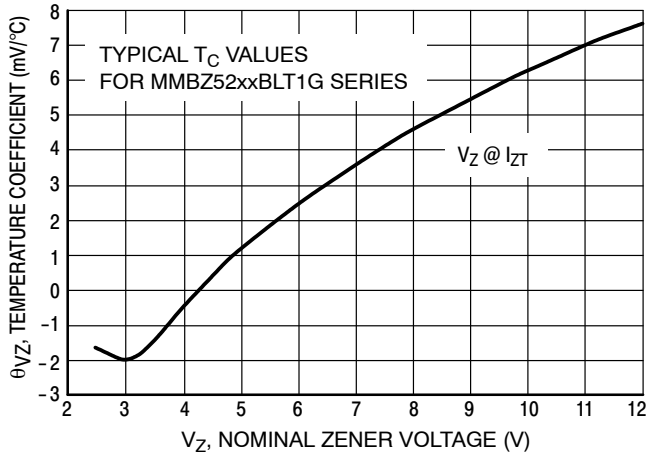

**Figure 1. Temperature Coefficients  
(Temperature Range -55°C to +150°C)**

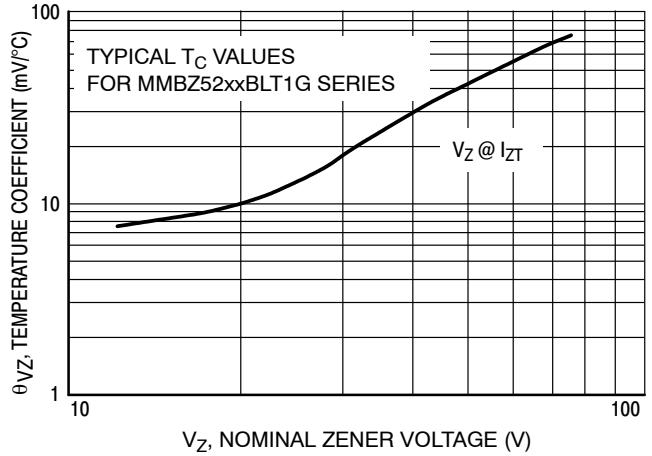

**Figure 2. Temperature Coefficients  
(Temperature Range -55°C to +150°C)**

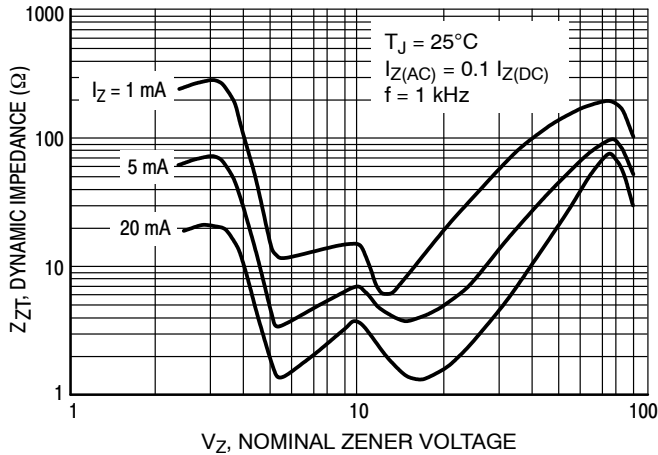

**Figure 3. Effect of Zener Voltage on  
Zener Impedance**

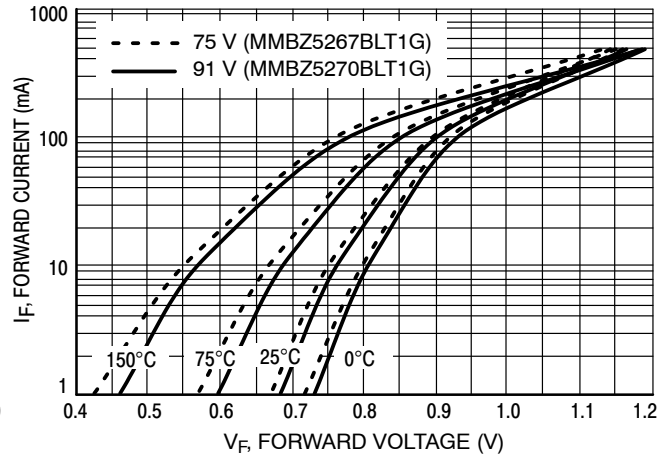

**Figure 4. Typical Forward Voltage**

TYPICAL CHARACTERISTICS

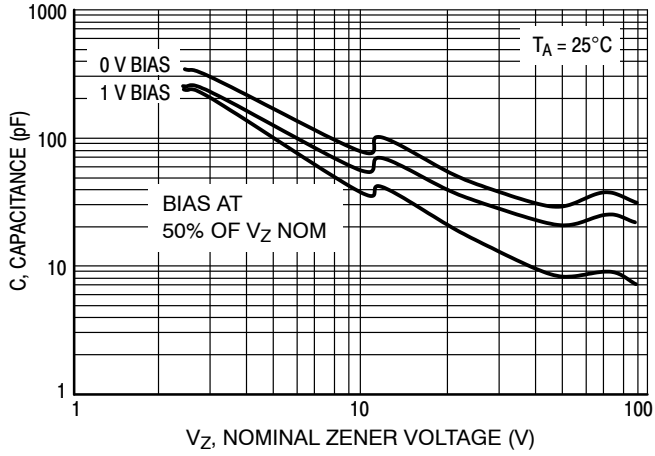

Figure 5. Typical Capacitance

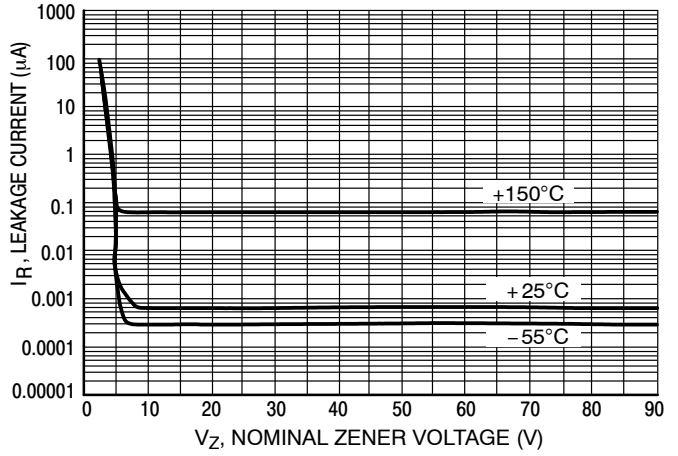

Figure 6. Typical Leakage Current

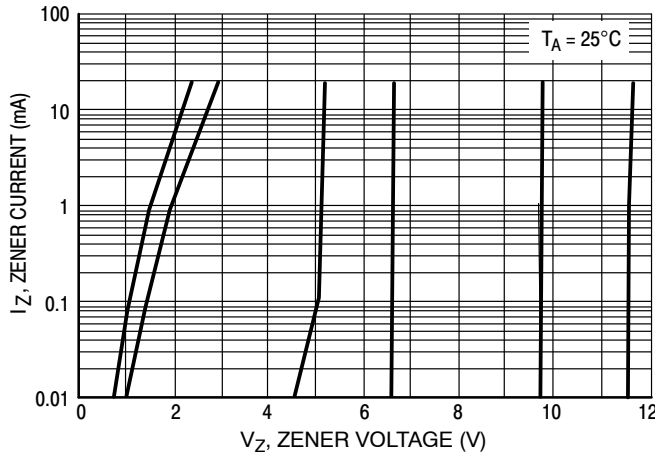

Figure 7. Zener Voltage versus Zener Current ( $V_Z$  Up to 12 V)

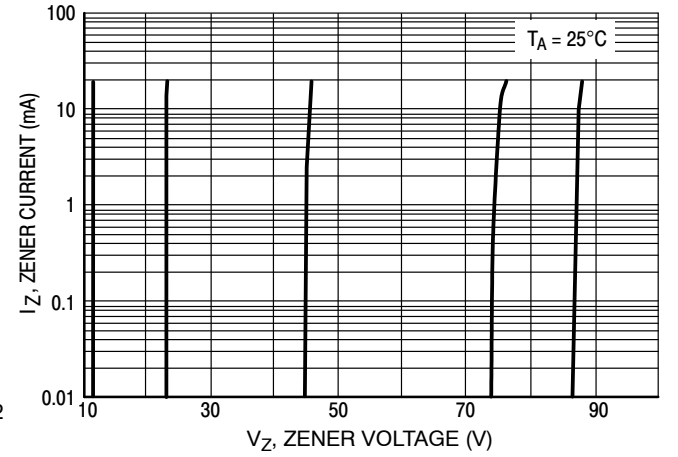
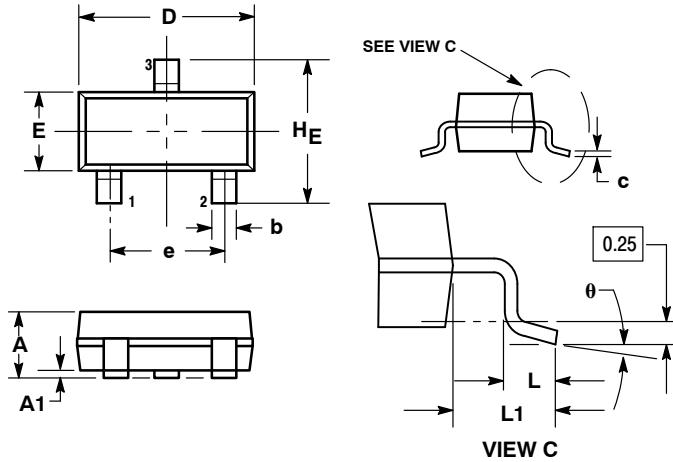

Figure 8. Zener Voltage versus Zener Current (12 V to 91 V)

# MMBZ52xxBLT1G Series, SZMMBZ52xxBLT1G Series

## PACKAGE DIMENSIONS

SOT-23 (TO-236)  
CASE 318-08  
ISSUE AP



NOTES:

1. DIMENSIONING AND TOLERANCING PER ANSI Y14.5M, 1982.
2. CONTROLLING DIMENSION: INCH.
3. MAXIMUM LEAD THICKNESS INCLUDES LEAD FINISH THICKNESS. MINIMUM LEAD THICKNESS IS THE MINIMUM THICKNESS OF BASE MATERIAL.
4. DIMENSIONS D AND E DO NOT INCLUDE MOLD FLASH, PROTRUSIONS, OR GATE BURRS.

DIM	MILLIMETERS			INCHES		
	MIN	NOM	MAX	MIN	NOM	MAX
A	0.89	1.00	1.11	0.035	0.040	0.044
A1	0.01	0.06	0.10	0.001	0.002	0.004
b	0.37	0.44	0.50	0.015	0.018	0.020
c	0.09	0.13	0.18	0.003	0.005	0.007
D	2.80	2.90	3.04	0.110	0.114	0.120
E	1.20	1.30	1.40	0.047	0.051	0.055
e	1.78	1.90	2.04	0.070	0.075	0.081
L	0.10	0.20	0.30	0.004	0.008	0.012
L1	0.35	0.54	0.69	0.014	0.021	0.029
HE	2.10	2.40	2.64	0.083	0.094	0.104
θ	0°	---	10°	0°	---	10°

STYLE 8:

1. ANODE
2. NO CONNECTION
3. CATHODE

### SOLDERING FOOTPRINT\*

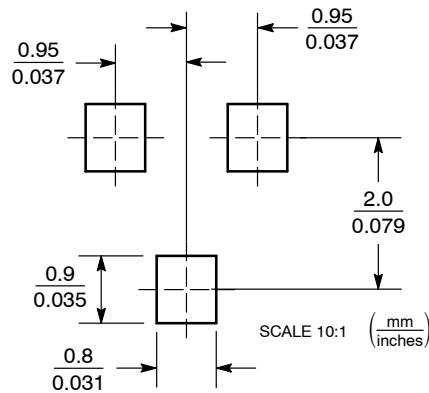

\*For additional information on our Pb-Free strategy and soldering details, please download the ON Semiconductor Soldering and Mounting Techniques Reference Manual, SOLDERRM/D.

ON Semiconductor and are registered trademarks of Semiconductor Components Industries, LLC (SCILLC). SCILLC reserves the right to make changes without further notice to any products herein. SCILLC makes no warranty, representation or guarantee regarding the suitability of its products for any particular purpose, nor does SCILLC assume any liability arising out of the application or use of any product or circuit, and specifically disclaims any and all liability, including without limitation special, consequential or incidental damages. "Typical" parameters which may be provided in SCILLC data sheets and/or specifications can and do vary in different applications and actual performance may vary over time. All operating parameters, including "Typicals" must be validated for each customer application by customer's technical experts. SCILLC does not convey any license under its patent rights nor the rights of others. SCILLC products are not designed, intended, or authorized for use as components in systems intended for surgical implant into the body, or other applications intended to support or sustain life, or for any other application in which the failure of the SCILLC product could create a situation where personal injury or death may occur. Should Buyer purchase or use SCILLC products for any such unintended or unauthorized application, Buyer shall indemnify and hold SCILLC and its officers, employees, subsidiaries, affiliates, and distributors harmless against all claims, costs, damages, and expenses, and reasonable attorney fees arising out of, directly or indirectly, any claim of personal injury or death associated with such unintended or unauthorized use, even if such claim alleges that SCILLC was negligent regarding the design or manufacture of the part. SCILLC is an Equal Opportunity/Affirmative Action Employer. This literature is subject to all applicable copyright laws and is not for resale in any manner.

### PUBLICATION ORDERING INFORMATION

**LITERATURE FULFILLMENT:**  
Literature Distribution Center for ON Semiconductor  
P.O. Box 5163, Denver, Colorado 80217 USA  
**Phone:** 303-675-2175 or 800-344-3860 Toll Free USA/Canada  
**Fax:** 303-675-2176 or 800-344-3867 Toll Free USA/Canada  
**Email:** orderlit@onsemi.com

**N. American Technical Support:** 800-282-9855 Toll Free  
USA/Canada  
**Europe, Middle East and Africa Technical Support:**  
Phone: 421 33 790 2910  
**Japan Customer Focus Center**  
Phone: 81-3-5817-1050

**ON Semiconductor Website:** [www.onsemi.com](http://www.onsemi.com)  
**Order Literature:** <http://www.onsemi.com/orderlit>  
For additional information, please contact your local Sales Representative