



# 8-Channel, 24-Bit ANALOG-TO-DIGITAL CONVERTER

## FEATURES

- 24 BITS NO MISSING CODES
- 0.0015% INL
- 22 BITS EFFECTIVE RESOLUTION (PGA = 1), 19 BITS (PGA = 128)
- PGA FROM 1 TO 128
- SINGLE CYCLE SETTLING MODE
- PROGRAMMABLE DATA OUTPUT RATES UP TO 1kHz
- ON-CHIP 1.25V/2.5V REFERENCE
- EXTERNAL DIFFERENTIAL REFERENCE OF 0.1V TO 2.5V
- ON-CHIP CALIBRATION
- SPI™ COMPATIBLE
- 2.7V TO 5.25V
- < 1mW POWER CONSUMPTION

## APPLICATIONS

- INDUSTRIAL PROCESS CONTROL
- LIQUID/GAS CHROMATOGRAPHY
- BLOOD ANALYSIS
- SMART TRANSMITTERS
- PORTABLE INSTRUMENTATION
- WEIGHT SCALES
- PRESSURE TRANSDUCERS

SPI is a registered trademark of Motorola.

## DESCRIPTION

The ADS1216 is a precision, wide dynamic range, delta-sigma, Analog-to-Digital (A/D) converter with 24-bit resolution operating from 2.7V to 5.25V supplies. The delta-sigma, A/D converter provides up to 24 bits of no missing code performance and effective resolution of 22 bits.

The eight input channels are multiplexed. Internal buffering can be selected to provide a very high input impedance for direct connection to transducers or low-level voltage signals. Burn out current sources are provided that allow for the detection of an open or shorted sensor. An 8-bit Digital-to-Analog (D/A) converter provides an offset correction with a range of 50% of the FSR (Full-Scale Range).

The PGA (Programmable Gain Amplifier) provides selectable gains of 1 to 128 with an effective resolution of 19 bits at a gain of 128. The A/D conversion is accomplished with a second-order delta-sigma modulator and programmable sinc filter. The reference input is differential and can be used for ratiometric cancellation. The on-board current DACs (Digital-to-Analog Converters) operate independently with the maximum current set by an external resistor.

The serial interface is SPI compatible. Eight bits of digital I/O are also provided that can be used for input or output. The ADS1216 is designed for high-resolution measurement applications in smart transmitters, industrial process control, weight scales, chromatography, and portable instrumentation.

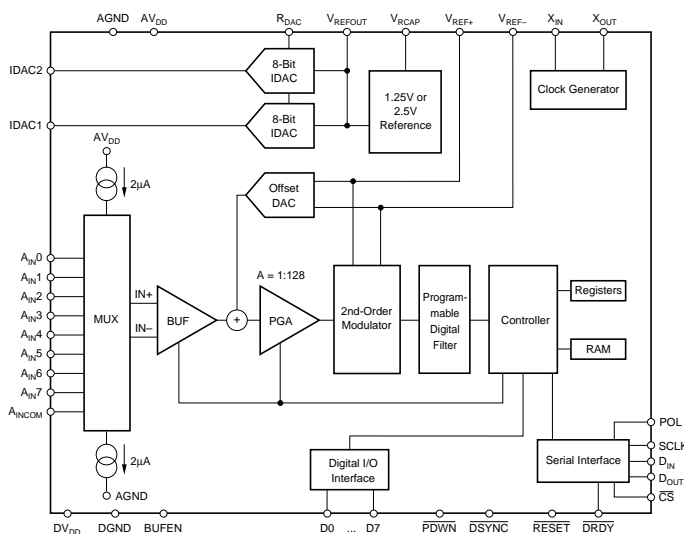

Please be aware that an important notice concerning availability, standard warranty, and use in critical applications of Texas Instruments semiconductor products and disclaimers thereto appears at the end of this data sheet.

## ABSOLUTE MAXIMUM RATINGS<sup>(1)</sup>

AV <sub>DD</sub> to AGND .....	-0.3V to +6V
DV <sub>DD</sub> to DGND .....	-0.3V to +6V
Input Current .....	100mA, Momentary
Input Current .....	10mA, Continuous
A <sub>IN</sub> .....	GND -0.5V to AV <sub>DD</sub> + 0.5V
AV <sub>DD</sub> to DV <sub>DD</sub> .....	-6V to +6V
AGND to DGND .....	-0.3V to +0.3V
Digital Input Voltage to GND .....	-0.3V to DV <sub>DD</sub> + 0.3V
Digital Output Voltage to GND .....	-0.3V to DV <sub>DD</sub> + 0.3V
Maximum Junction Temperature .....	+150°C
Operating Temperature Range .....	-40°C to +85°C
Storage Temperature Range .....	-60°C to +100°C
Lead Temperature (soldering, 10s) .....	+300°C

NOTE: (1) Stresses above those listed under "Absolute Maximum Ratings" may cause permanent damage to the device. Exposure to absolute maximum conditions for extended periods may affect device reliability.



## ELECTROSTATIC DISCHARGE SENSITIVITY

This integrated circuit can be damaged by ESD. Texas Instruments recommends that all integrated circuits be handled with appropriate precautions. Failure to observe proper handling and installation procedures can cause damage.

ESD damage can range from subtle performance degradation to complete device failure. Precision integrated circuits may be more susceptible to damage because very small parametric changes could cause the device not to meet its published specifications.

## PACKAGE/ORDERING INFORMATION

PRODUCT	PACKAGE	PACKAGE DRAWING NUMBER	SPECIFIED TEMPERATURE RANGE	PACKAGE MARKING	ORDERING NUMBER <sup>(1)</sup>	TRANSPORT MEDIA
ADS1216Y	TQFP-48	PFB	-40 to +85	ADS1216Y	ADS1216Y/250	Tape and Reel
"	"	"	"	"	ADS1216Y/2K	Tape and Reel

NOTE: (1) Models with a slash (/) are available only in Tape and Reel in the quantities indicated (e.g., /2K indicates 2000 devices per reel). Ordering 2000 pieces of "ADS1216Y/2K" will get a single 2000-piece Tape and Reel.

## ELECTRICAL CHARACTERISTICS: AV<sub>DD</sub> = 5V

All specifications T<sub>MIN</sub> to T<sub>MAX</sub>, AV<sub>DD</sub> = +5V, DV<sub>DD</sub> = +2.7V to 5.25V, f<sub>MOD</sub> = 19.2kHz, PGA = 1, Buffer ON, R<sub>DAC</sub> = 150kΩ, f<sub>DATA</sub> = 10Hz, V<sub>REF</sub> = (REF IN+) - (REF IN-) = +2.5V, unless otherwise specified.

PARAMETER	CONDITIONS	ADS1216			UNITS
		MIN	TYP	MAX	
<b>ANALOG INPUT (A<sub>IN0</sub> - A<sub>IN7</sub>, A<sub>INCOM</sub>)</b>					
Analog Input Range	Buffer OFF Buffer ON	AGND - 0.1 AGND + 0.05		AV <sub>DD</sub> + 0.1 AV <sub>DD</sub> - 1.5	V V
Full-Scale Input Voltage Range	(In+) - (In-), See Block Diagram			±V <sub>REF</sub> /PGA	V
Differential Input Impedance	Buffer OFF		5/PGA		MΩ
Input Current	Buffer ON		0.5		nA
Bandwidth					
Fast Settling Filter	-3dB		0.469 • f <sub>DATA</sub>		Hz
Sinc <sup>2</sup> Filter	-3dB		0.318 • f <sub>DATA</sub>		Hz
Sinc <sup>3</sup> Filter	-3dB		0.262 • f <sub>DATA</sub>		Hz
Programmable Gain Amplifier	User Selectable Gain Ranges	1		128	
Input Capacitance			9		pF
Input Leakage Current	Modulator OFF, T = 25°C		5		pA
Burnout Current Sources			2		μA
<b>OFFSET DAC</b>					
Offset DAC Range		8		±V <sub>REF</sub> /(2 • PGA)	V
Offset DAC Monotonicity				±10	Bits
Offset DAC Gain Error				1	%
Offset DAC Gain Error Drift					ppm/°C
<b>SYSTEM PERFORMANCE</b>					
Resolution		24			Bits
No Missing Codes	sinc <sup>3</sup> Filter			24	Bits
Integral Non-Linearity	End Point Fit			±0.0015	% of FS
Offset Error <sup>(1)</sup>			7.5		ppm of FS
Offset Drift <sup>(1)</sup>			0.02		ppm of FS/°C
Gain Error <sup>(1)</sup>			0.005		%
Gain Error Drift <sup>(1)</sup>			0.5		ppm/°C
Common-Mode Rejection	at DC	100			dB
	f <sub>CM</sub> = 60Hz, f <sub>DATA</sub> = 10Hz		130		dB
	f <sub>CM</sub> = 50Hz, f <sub>DATA</sub> = 50Hz		120		dB
	f <sub>CM</sub> = 60Hz, f <sub>DATA</sub> = 60Hz		120		dB
Normal-Mode Rejection	f <sub>SIG</sub> = 50Hz, f <sub>DATA</sub> = 50Hz		100		dB
	f <sub>SIG</sub> = 60Hz, f <sub>DATA</sub> = 60Hz		100		dB
Output Noise			See Typical Characteristics		dB
Power-Supply Rejection	at DC, dB = -20 log(ΔV <sub>OUT</sub> /ΔV <sub>DD</sub> ) <sup>(2)</sup>	80	95		dB

# ELECTRICAL CHARACTERISTICS: AV<sub>DD</sub> = 5V (Cont.)

All specifications T<sub>MIN</sub> to T<sub>MAX</sub>, AV<sub>DD</sub> = +5V, DV<sub>DD</sub> = +2.7V to 5.25V, f<sub>MOD</sub> = 19.2kHz, PGA = 1, Buffer ON, R<sub>DAC</sub> = 150kΩ, f<sub>DATA</sub> = 10Hz, V<sub>REF</sub> = (REF IN+) – (REF IN-) = +2.5V, unless otherwise specified.

PARAMETER	CONDITIONS	ADS1216			UNITS
		MIN	TYP	MAX	
<b>VOLTAGE REFERENCE INPUT</b>					
Reference Input Range	REF IN+, REF IN- V <sub>REF</sub> = (REF IN+) – (REF IN-)	AGND		AV <sub>DD</sub>	V
V <sub>REF</sub>		0.1	2.5	2.6	V
Common-Mode Rejection	at DC		120		dB
Common-Mode Rejection	f <sub>VREFCM</sub> = 60Hz, f <sub>DATA</sub> = 60Hz		120		dB
Bias Current <sup>(3)</sup>	V <sub>REF</sub> = 2.5V		1.3		μA
<b>ON-CHIP VOLTAGE REFERENCE</b>					
Output Voltage	REF HI = 1 REF HI = 0	2.4	2.50	2.6	V
Short-Circuit Current Source			1.25		V
Short-Circuit Current Sink			8		mA
Short-Circuit Duration	Sink or Source		50		μA
Drift			Indefinite		
Noise	V <sub>RCAP</sub> = 0.1μF, BW = 0.1Hz to 100Hz		15		ppm/°C
Output Impedance	Sourcing 100μA		10		μVp-p
Startup Time			3		Ω
			50		μs
<b>IDAC</b>					
Full-Scale Output Current	R <sub>DAC</sub> = 150kΩ, Range = 1 R <sub>DAC</sub> = 150kΩ, Range = 2 R <sub>DAC</sub> = 150kΩ, Range = 3 R <sub>DAC</sub> = 15kΩ, Range = 3		0.5 1 2 20		mA mA mA mA
Maximum Short-Circuit Current Duration	R <sub>DAC</sub> = 10kΩ R <sub>DAC</sub> = 0Ω		Indefinite	10	Minute
Monotonicity	R <sub>DAC</sub> = 150kΩ	8			Bits
Compliance Voltage		0		AV <sub>DD</sub> – 1	V
Output Impedance			See Typical Characteristics		
PSRR	V <sub>OUT</sub> = AV <sub>DD</sub> /2		400		ppm/V
Absolute Error	Individual IDAC		5		%
Absolute Drift	Individual IDAC		75		ppm/°C
Mismatch Error	Between IDACs, Same Range and Code		0.25		%
Mismatch Drift	Between IDACs, Same Range and Code		15		ppm/°C
<b>POWER-SUPPLY REQUIREMENTS</b>					
Power-Supply Voltage	AV <sub>DD</sub>	4.75		5.25	V
Analog Current (I <sub>ADC</sub> + I <sub>VREF</sub> + I <sub>DAC</sub> )	PDWN = 0, or SLEEP PGA = 1, Buffer OFF		1		nA
ADC Current (I <sub>ADC</sub> )	PGA = 128, Buffer OFF		140	225	μA
	PGA = 1, Buffer ON		430	650	μA
	PGA = 128, Buffer ON		180	275	μA
V <sub>REF</sub> Current (I <sub>VREF</sub> )			800	1250	μA
I <sub>DAC</sub> Current (I <sub>DAC</sub> )	Excludes Load Current		250	375	μA
Digital Current	Normal Mode, DV <sub>DD</sub> = 5V		480	675	μA
	SLEEP Mode, DV <sub>DD</sub> = 5V		180	275	μA
	Read Data Continuous Mode, DV <sub>DD</sub> = 5V		150		μA
	PDWN		230		μA
Power Dissipation	PGA = 1, Buffer OFF, REFEN = 0, I <sub>DACS</sub> OFF, DV <sub>DD</sub> = 5V		1		nA
			1.6	2.5	mW
<b>TEMPERATURE RANGE</b>					
Operating		-40		+85	°C
Storage		-60		+100	°C

NOTES: (1) Calibration can minimize these errors. (2) Δ V<sub>OUT</sub> is change in digital result. (3) 12pF switched capacitor at f<sub>SAMP</sub> clock frequency.

# ELECTRICAL CHARACTERISTICS: $AV_{DD} = 3V$

All specifications  $T_{MIN}$  to  $T_{MAX}$ ,  $AV_{DD} = +3V$ ,  $DV_{DD} = +2.7V$  to  $5.25V$ ,  $f_{MOD} = 19.2kHz$ ,  $PGA = 1$ , Buffer ON,  $R_{DAC} = 75k\Omega$ ,  $f_{DATA} = 10Hz$ ,  $V_{REF} = (REF\ IN+) - (REF\ IN-) = +1.25V$  unless otherwise specified.

PARAMETER	CONDITIONS	ADS1216			UNITS
		MIN	TYP	MAX	
<b>ANALOG INPUT (<math>A_{IN0} - A_{IN7}, A_{INCOM}</math>)</b> Analog Input Range	Buffer OFF Buffer ON	AGND - 0.1 AGND + 0.05		$AV_{DD} + 0.1$ $AV_{DD} - 1.5$	V V
Full-Scale Input Voltage Range	(In+) - (In-) See Block Diagram			$\pm V_{REF}/PGA$	V
Input Impedance	Buffer OFF		5/PGA		M $\Omega$
Input Current	Buffer ON		0.5		nA
Bandwidth					
Fast Settling Filter	-3dB		$0.469 \cdot f_{DATA}$		Hz
Sinc <sup>2</sup> Filter	-3dB		$0.318 \cdot f_{DATA}$		Hz
Sinc <sup>3</sup> Filter	-3dB		$0.262 \cdot f_{DATA}$		Hz
Programmable Gain Amplifier	User Selectable Gain Ranges	1		128	
Input Capacitance			9		pF
Input Leakage Current	Modulator OFF, T = 25°C		5		pA
Burnout Current Sources			2		$\mu$ A
<b>OFFSET DAC</b>					
Offset DAC Range			$\pm V_{REF}/(2 \cdot PGA)$		V
Offset DAC Monotonicity		8			Bits
Offset DAC Gain Error			$\pm 10$		%
Offset DAC Gain Error Drift			2		ppm/°C
<b>SYSTEM PERFORMANCE</b>					
Resolution	sinc <sup>3</sup> Filter	24		24	Bits
No Missing Codes	End Point Fit			$\pm 0.0015$	Bits
Integral Non-Linearity					% of FS
Offset Error <sup>(1)</sup>			15		ppm of FS
Offset Drift <sup>(1)</sup>			0.04		ppm of FS/°C
Gain Error <sup>(1)</sup>			0.010		%
Gain Error Drift <sup>(1)</sup>			1.0		ppm/°C
Common-Mode Rejection	at DC	100			dB
	$f_{CM} = 60Hz, f_{DATA} = 10Hz$		130		dB
	$f_{CM} = 50Hz, f_{DATA} = 50Hz$		120		dB
	$f_{CM} = 60Hz, f_{DATA} = 60Hz$		120		dB
Normal-Mode Rejection	$f_{SIG} = 50Hz, f_{DATA} = 50Hz$		100		dB
	$f_{SIG} = 60Hz, f_{DATA} = 60Hz$		100		dB
Output Noise			See Typical Characteristics		
Power-Supply Rejection	at DC, dB = $-20 \log(\Delta V_{OUT}/\Delta V_{DD})^{(2)}$	75	90		dB
<b>VOLTAGE REFERENCE INPUT</b>					
Reference Input Range	REF IN+, REF IN-	0		$AV_{DD}$	V
$V_{REF}$	$V_{REF} = (REF\ IN+) - (REF\ IN-)$	0.1	1.25	1.3	V
Common-Mode Rejection	at DC		120		dB
Common-Mode Rejection	$f_{VREFCM} = 60Hz, f_{DATA} = 60Hz$		120		dB
Bias Current <sup>(3)</sup>	$V_{REF} = 1.25V$		0.65		$\mu$ A
<b>ON-CHIP VOLTAGE REFERENCE</b>					
Output Voltage	REF HI = 0	1.2	1.25	1.3	V
Short-Circuit Current Source			3		mA
Short-Circuit Current Sink			50		$\mu$ A
Short-Circuit Duration	Sink or Source		Indefinite		
Drift			15		ppm/°C
Noise	$V_{RCAP} = 0.1\mu F, BW = 0.1Hz$ to 100Hz		10		$\mu Vp-p$
Output Impedance	Sourcing 100 $\mu$ A		3		$\Omega$
Startup Time			50		$\mu s$
<b>IDAC</b>					
Full-Scale Output Current	$R_{DAC} = 75k\Omega, Range = 1$		0.5		mA
	$R_{DAC} = 75k\Omega, Range = 2$		1		mA
	$R_{DAC} = 75k\Omega, Range = 3$		2		mA
	$R_{DAC} = 15k\Omega, Range = 3$		20		mA
Maximum Short-Circuit Current Duration	$R_{DAC} = 10k\Omega$		Indefinite		
	$R_{DAC} = 0\Omega$			10	Minute
	$R_{DAC} = 75k\Omega$	8			Bits
Monotonicity		0		$AV_{DD} - 1$	V
Compliance Voltage			See Typical Characteristics		
Output Impedance			600		ppm/V
PSRR	$V_{OUT} = AV_{DD}/2$		5		%
Absolute Error	Individual IDAC		75		ppm/°C
Absolute Drift	Individual IDAC		0.25		%
Mismatch Error	Between IDACs, Same Range and Code		15		ppm/°C
Mismatch Drift	Between IDACs, Same Range and Code				ppm/°C

# ELECTRICAL CHARACTERISTICS: $AV_{DD} = 3V$ (Cont.)

All specifications  $T_{MIN}$  to  $T_{MAX}$ ,  $AV_{DD} = +3V$ ,  $DV_{DD} = +2.7V$  to  $5.25V$ ,  $f_{MOD} = 19.2kHz$ ,  $PGA = 1$ , Buffer ON,  $R_{DAC} = 75k\Omega$ ,  $f_{DATA} = 10Hz$ ,  $V_{REF} = (REF IN+) - (REF IN-) = +1.25V$  unless otherwise specified.

PARAMETER	CONDITIONS	ADS1216			UNITS
		MIN	TYP	MAX	
<b>POWER-SUPPLY REQUIREMENTS</b>					
Power-Supply Voltage	$AV_{DD}$	2.7		3.3	V
Analog Current ( $I_{ADC} + I_{VREF} + I_{DAC}$ )	$\overline{PDWN} = 0$ , or SLEEP PGA = 1, Buffer OFF		1		nA
ADC Current ( $I_{ADC}$ )	PGA = 1, Buffer OFF		120	200	$\mu A$
	PGA = 128, Buffer OFF		370	600	$\mu A$
	PGA = 1, Buffer ON		170	250	$\mu A$
	PGA = 128, Buffer ON		750	1200	$\mu A$
$V_{REF}$ Current ( $I_{VREF}$ )			250	375	$\mu A$
$I_{DAC}$ Current ( $I_{DAC}$ )	Excludes Load Current		480	675	$\mu A$
Digital Current	Normal Mode, $DV_{DD} = 3V$		90	200	$\mu A$
	SLEEP Mode, $DV_{DD} = 3V$		75		$\mu A$
	Read Data Continuous Mode, $DV_{DD} = 3V$		113		$\mu A$
	$\overline{PDWN} = 0$		1		nA
Power Dissipation	PGA = 1, Buffer OFF, REFEN = 0, $I_{DACS}$ OFF, $DV_{DD} = 3V$		0.6	1.2	mW
<b>TEMPERATURE RANGE</b>					
Operating		-40		+85	$^{\circ}C$
Storage		-60		+100	$^{\circ}C$

NOTES: (1) Calibration can minimize these errors. (2)  $\Delta V_{OUT}$  is change in digital result. (3) 12pF switched capacitor at  $f_{SAMP}$  clock frequency.

## DIGITAL SPECIFICATIONS: $T_{MIN}$ to $T_{MAX}$ , $DV_{DD} 2.7V$ to $5.25V$

PARAMETER	CONDITIONS	MIN	TYP	MAX	UNITS
Digital Input/Output					
Logic Family			CMOS		
Logic Level: $V_{IH}$		$0.8 \cdot DV_{DD}$		$DV_{DD}$	V
$V_{IL}$		DGND		$0.2 \cdot DV_{DD}$	V
$V_{OH}$	$I_{OH} = 1mA$	$DV_{DD} - 0.4$			V
$V_{OL}$	$I_{OL} = 1mA$	DGND			V
Input Leakage: $I_{IH}$	$V_I = DV_{DD}$			DGND + 0.4	$\mu A$
$I_{IL}$	$V_I = 0$	-10		10	$\mu A$
Master Clock Rate: $f_{OSC}$		1		5	MHz
Master Clock Period: $t_{OSC}$	$1/f_{OSC}$	200		1000	ns

## PIN CONFIGURATION

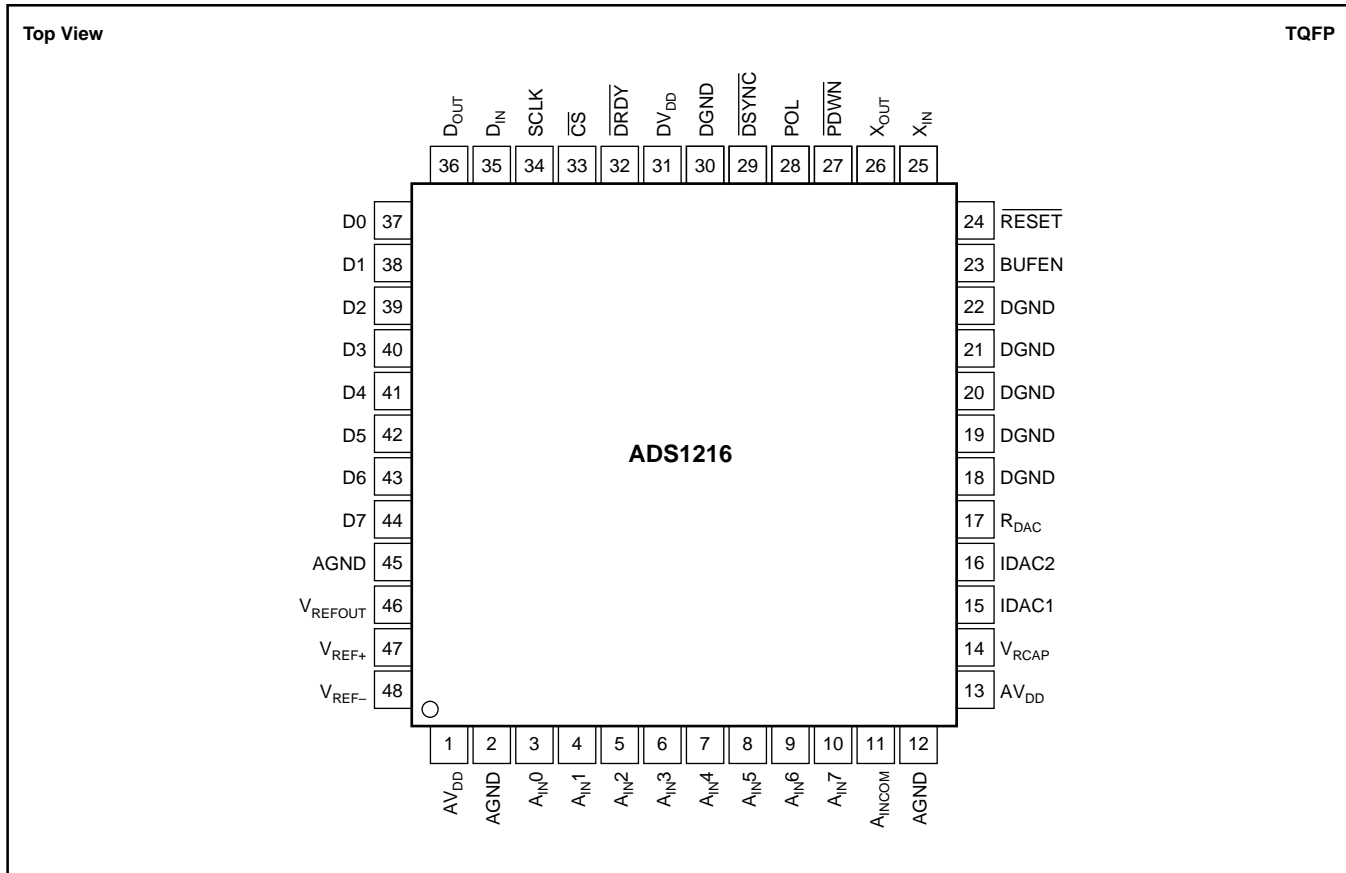

## PIN DESCRIPTIONS

PIN NUMBER	NAME	DESCRIPTION	PIN NUMBER	NAME	DESCRIPTION
1	AV <sub>DD</sub>	Analog Power Supply	25	X <sub>IN</sub>	Clock Input
2	AGND	Analog Ground	26	X <sub>OUT</sub>	Clock Output, used with crystal or resonator.
3	A <sub>IN0</sub>	Analog Input 0	27	PDWN	Active LOW. Power Down. The power down function shuts down the analog and digital circuits.
4	A <sub>IN1</sub>	Analog Input 1			
5	A <sub>IN2</sub>	Analog Input 2	28	POL	Serial Clock Polarity
6	A <sub>IN3</sub>	Analog Input 3	29	DSYNC	Active LOW, Synchronization Control
7	A <sub>IN4</sub>	Analog Input 4	30	DGND	Digital Ground
8	A <sub>IN5</sub>	Analog Input 5	31	DV <sub>DD</sub>	Digital Power Supply
9	A <sub>IN6</sub>	Analog Input 6	32	DRDY	Active LOW, Data Ready
10	A <sub>IN7</sub>	Analog Input 7	33	CS	Active LOW, Chip Select
11	A <sub>INCOM</sub>	Analog Input Common	34	SCLK	Serial Clock, Schmitt Trigger
12	AGND	Analog Ground	35	D <sub>IN</sub>	Serial Data Input, Schmitt Trigger
13	AV <sub>DD</sub>	Analog Power Supply	36	D <sub>OUT</sub>	Serial Data Output
14	V <sub>REFCAP</sub>	V <sub>REF</sub> Bypass CAP	37-44	D0-D7	Digital I/O 0-7
15	IDAC1	Current DAC1 Output	45	AGND	Analog Ground
16	IDAC2	Current DAC2 Output	46	V <sub>REFOUT</sub>	Voltage Reference Output
17	R <sub>DAC</sub>	Current DAC Resistor	47	V <sub>REF+</sub>	Positive Differential Reference Input
18-22	DGND	Digital Ground	48	V <sub>REF-</sub>	Negative Differential Reference Input
23	BUFEN	Buffer Enable			
24	RESET	Active LOW, resets the entire chip.			

## TIMING DIAGRAMS

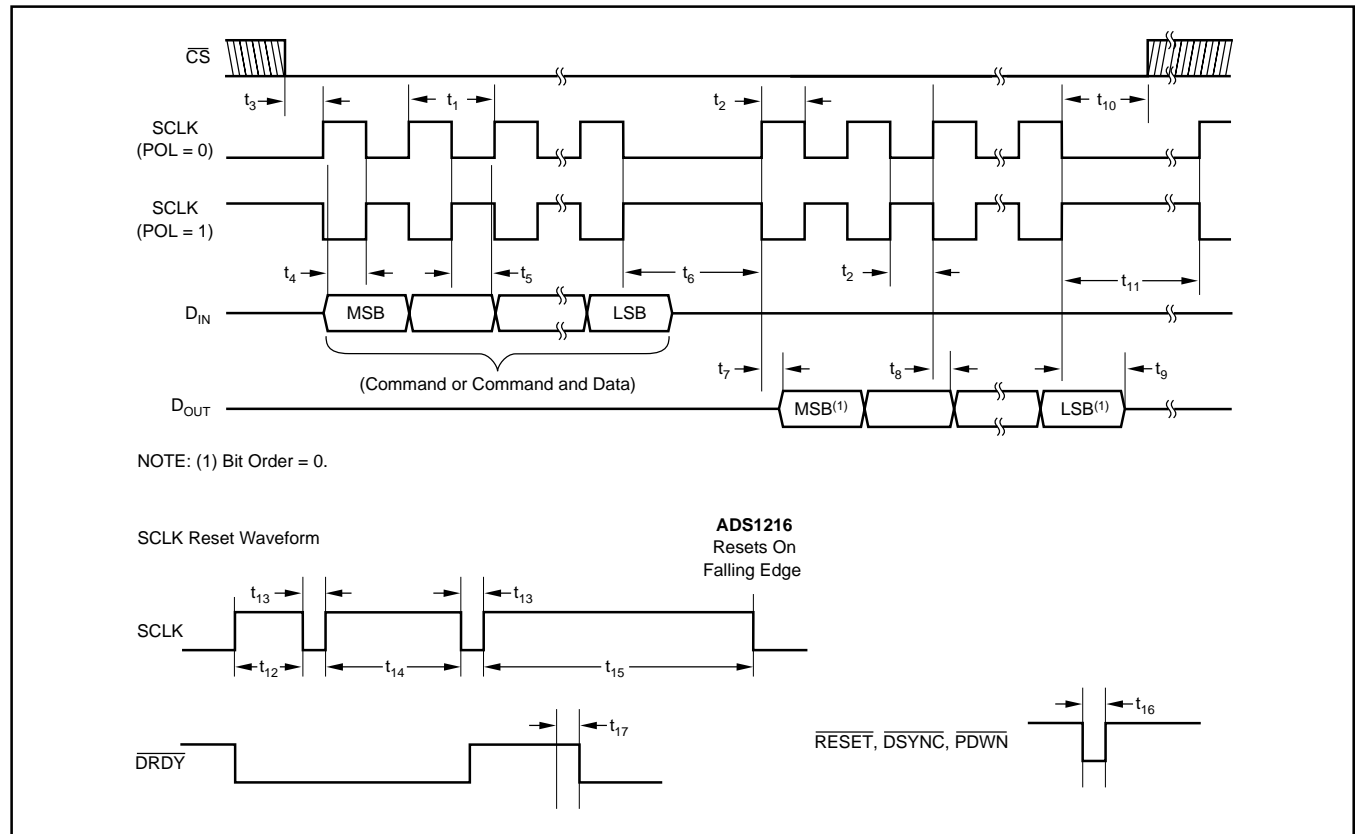

## TIMING CHARACTERISTICS

SPEC	DESCRIPTION	MIN	MAX	UNITS
$t_1$	SCLK Period	4	3	$t_{osc}$ Periods $\overline{DRDY}$ Periods
$t_2$	SCLK Pulse Width, HIGH and LOW	200		ns
$t_3$	$\overline{CS}$ LOW to first SCLK Edge; Setup Time <sup>(2)</sup>	0		ns
$t_4$	$D_{IN}$ Valid to SCLK Edge; Setup Time	50		ns
$t_5$	Valid $D_{IN}$ to SCLK Edge; Hold Time	50		ns
$t_6$	Delay between last SCLK edge for $D_{IN}$ and first SCLK edge for $D_{OUT}$ :			
	RDATA, RDATA, RREG, WREG, RRAM, WRAM	50		$t_{osc}$ Periods
	CSREG, CSRAMX, CSRAM	200		$t_{osc}$ Periods
	CSARAM, CSARAMX	1100		$t_{osc}$ Periods
$t_7^{(1)}$	SCLK Edge to Valid New $D_{OUT}$		50	ns
$t_8^{(1)}$	SCLK Edge to $D_{OUT}$ , Hold Time	0		ns
$t_9$	Last SCLK Edge to $D_{OUT}$ Tri-State NOTE: $D_{OUT}$ goes tri-state immediately when $\overline{CS}$ goes HIGH.	6	10	$t_{osc}$ Periods
$t_{10}$	$\overline{CS}$ LOW time after final SCLK edge	0		ns
$t_{11}$	Final SCLK edge of one op code until first edge SCLK of next command:			$t_{osc}$ Periods
	RREG, WREG, RRAM, WRAM, CSRAMX, CSARAMX, CSRAM, CSARAM, CSREG, DSYNC, SLEEP, RDATA, RDATA, STOPC	4		$t_{osc}$ Periods
	CREG, CRAM	220		$t_{osc}$ Periods
	CREGA	1600		$t_{osc}$ Periods
	SELFGCAL, SELFOCAL, SYSOCAL, SYSGCAL	7		$\overline{DRDY}$ Periods
	SELFCAL	14		$\overline{DRDY}$ Periods
	RESET (Command, SCLK or Pin)	16		$t_{osc}$ Periods
$t_{12}$		300	500	$t_{osc}$ Periods
$t_{13}$		5		$t_{osc}$ Periods
$t_{14}$		550		$t_{osc}$ Periods
$t_{15}$		1050	1250	$t_{osc}$ Periods
$t_{16}$	Pulse Width	4		$t_{osc}$ Periods
$t_{17}$	DOR Data Not Valid	4		$t_{osc}$ Periods

NOTE: (1) Load = 20pF || 10k $\Omega$  to DGND. (2)  $\overline{CS}$  may be tied LOW.

# TYPICAL CHARACTERISTICS

$A_{V_{DD}} = +5V$ ,  $DV_{DD} = +5V$ ,  $f_{OSC} = 2.4576MHz$ ,  $PGA = 1$ ,  $R_{DAC} = 150k\Omega$ ,  $f_{DATA} = 10Hz$ ,  $V_{REF} = (REF IN+) - (REF IN-) = +2.5V$ , unless otherwise specified.

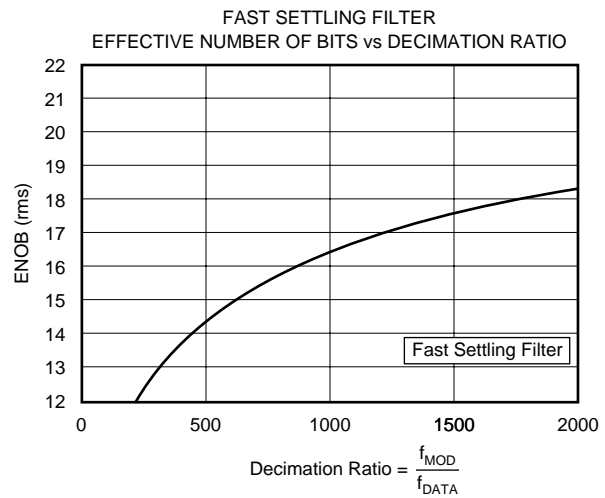
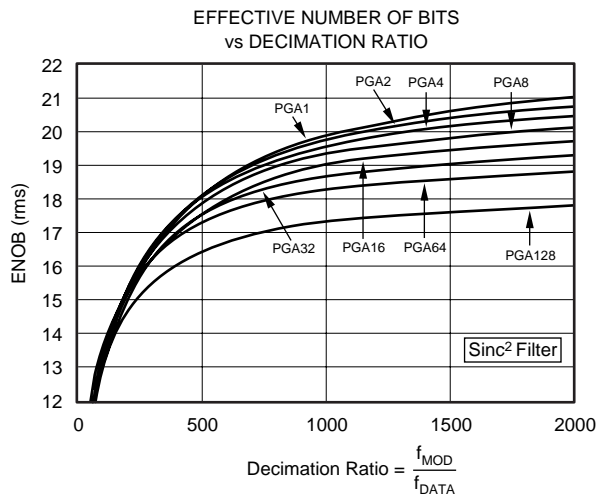
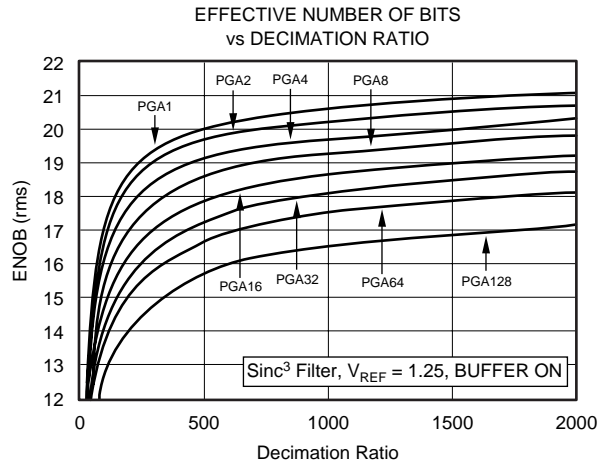
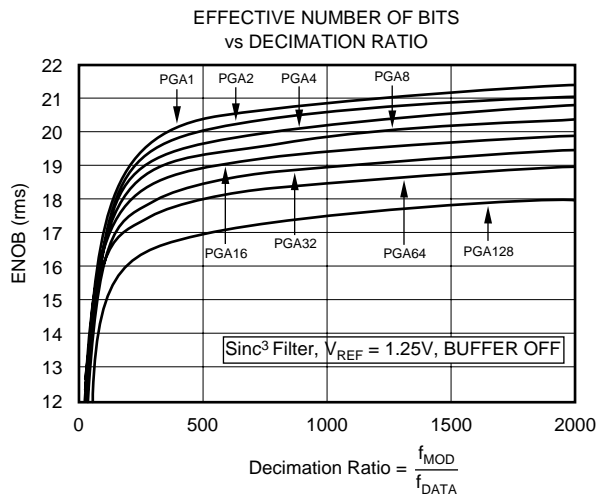
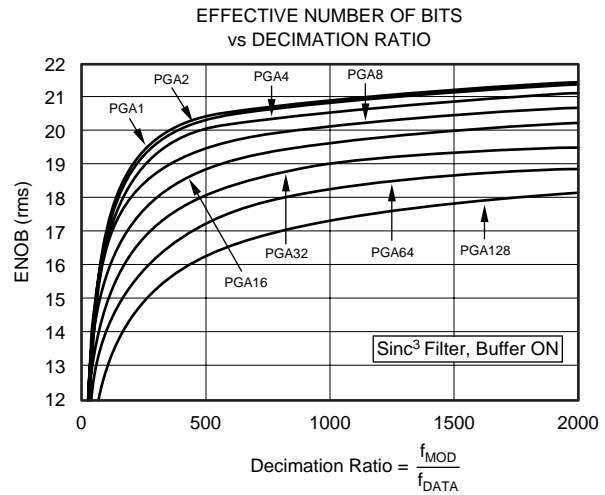
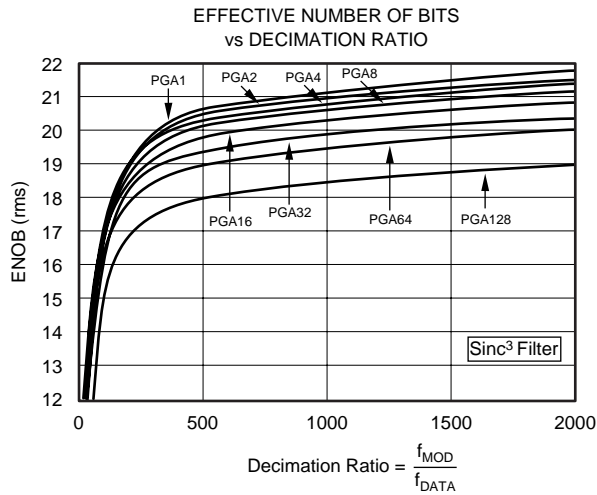



# TYPICAL CHARACTERISTICS (Cont.)

$V_{DD} = +5V$ ,  $DV_{DD} = +5V$ ,  $f_{OSC} = 2.4576MHz$ ,  $PGA = 1$ ,  $R_{DAC} = 150k\Omega$ ,  $f_{DATA} = 10Hz$ ,  $V_{REF} \equiv (REF\ IN+) - (REF\ IN-) = +2.5V$ , unless otherwise specified.

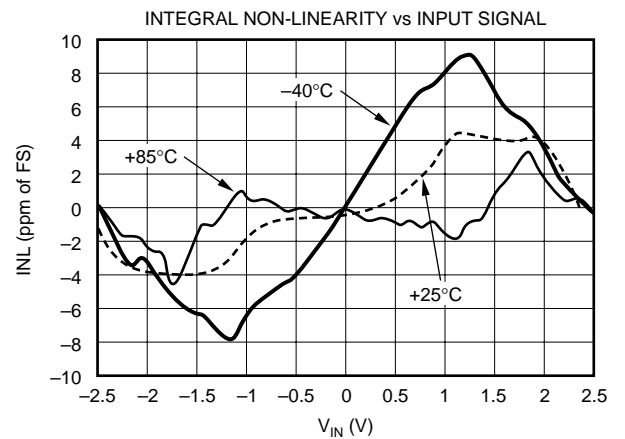
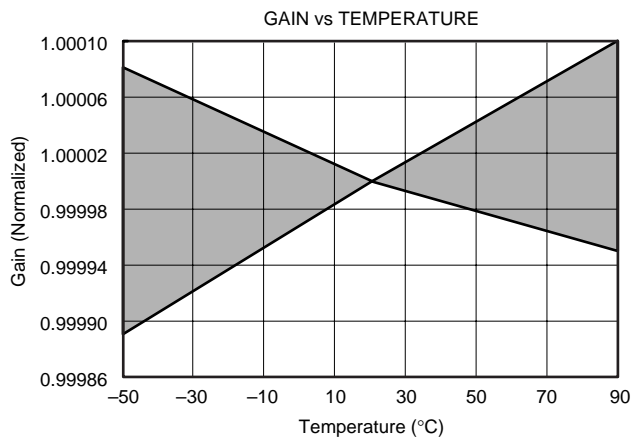
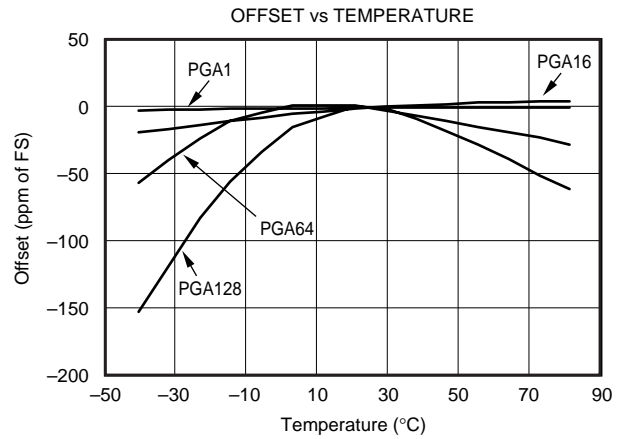
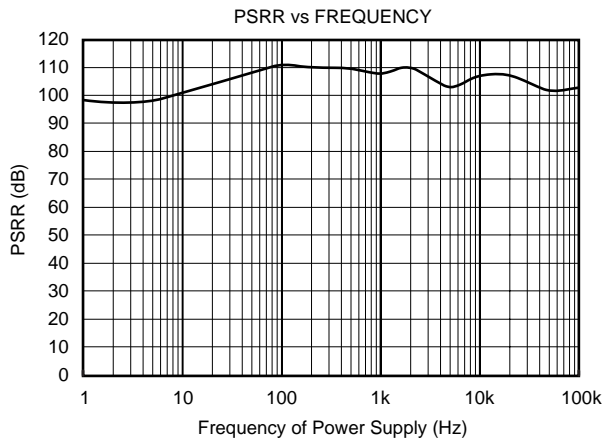
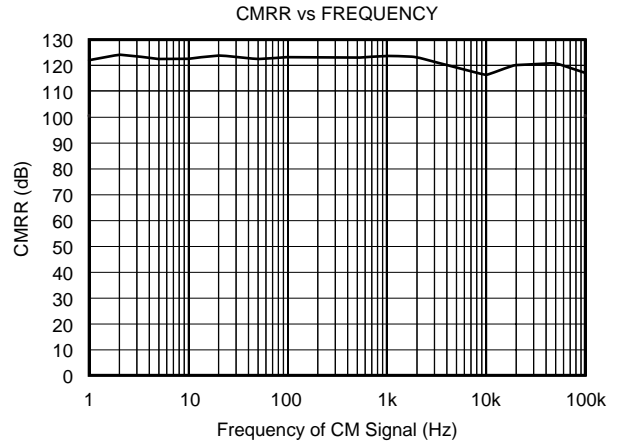
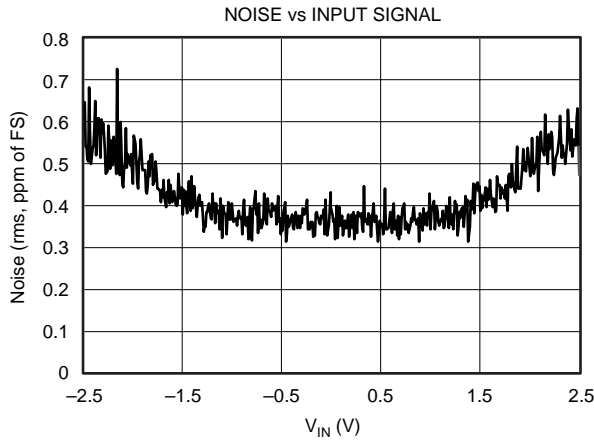

# TYPICAL CHARACTERISTICS (Cont.)

$AV_{DD} = +5V$ ,  $DV_{DD} = +5V$ ,  $f_{OSC} = 2.4576MHz$ ,  $PGA = 1$ ,  $R_{DAC} = 150k\Omega$ ,  $f_{DATA} = 10Hz$ ,  $V_{REF} \equiv (REF\ IN+) - (REF\ IN-) = +2.5V$ , unless otherwise specified.

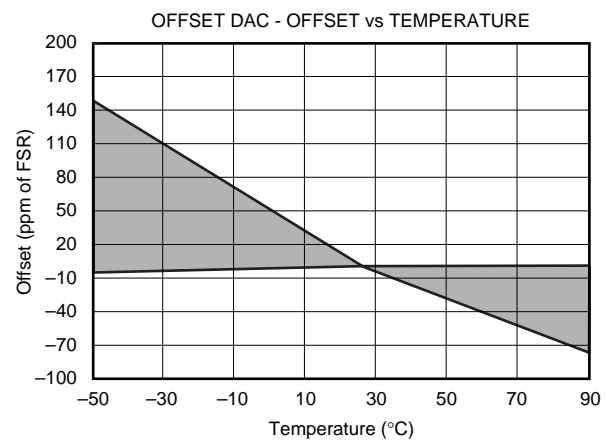
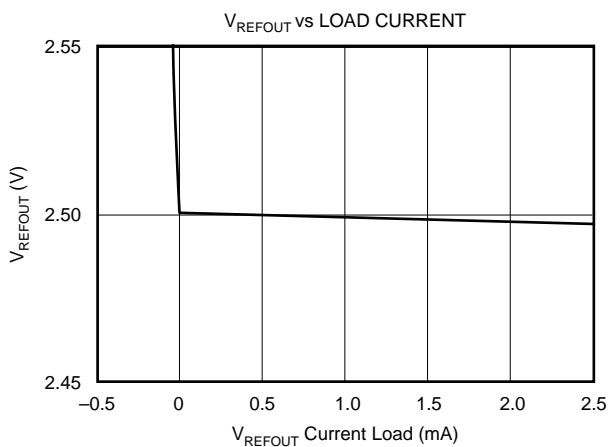
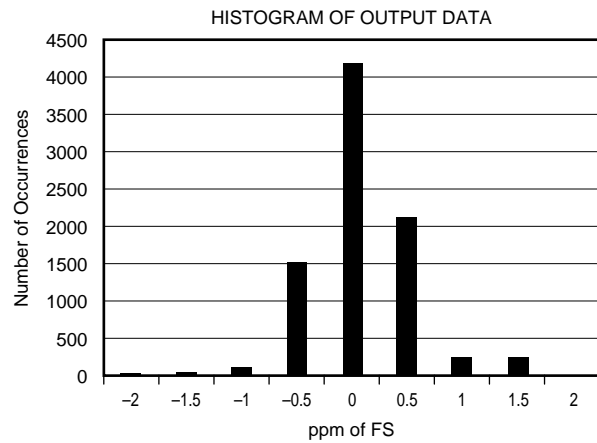
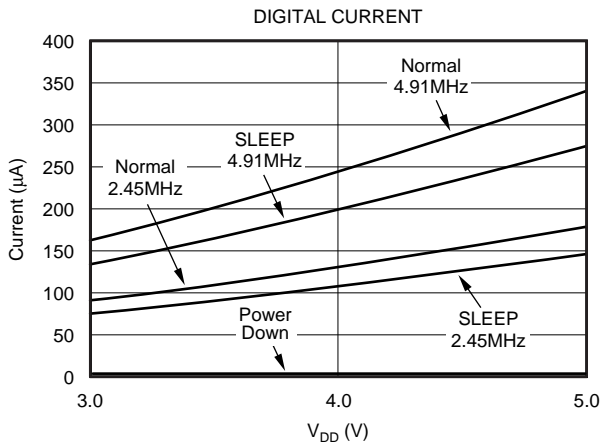
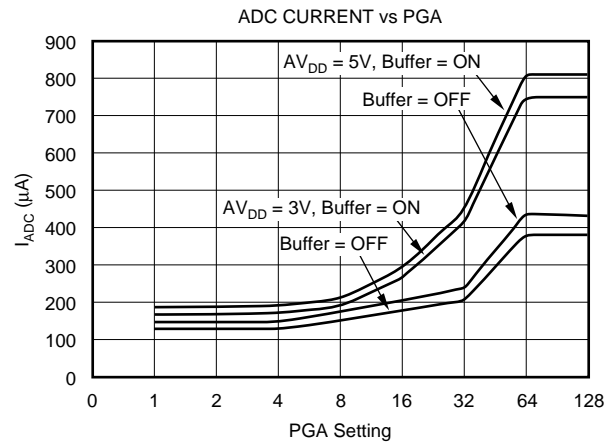
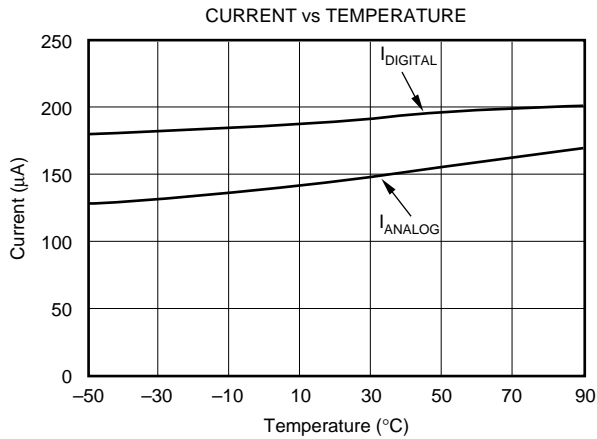

# TYPICAL CHARACTERISTICS (Cont.)

$V_{DD} = +5V$ ,  $DV_{DD} = +5V$ ,  $f_{OSC} = 2.4576MHz$ ,  $PGA = 1$ ,  $R_{DAC} = 150k\Omega$ ,  $f_{DATA} = 10Hz$ ,  $V_{REF} \equiv (REF\ IN+) - (REF\ IN-) = +2.5V$ , unless otherwise specified.

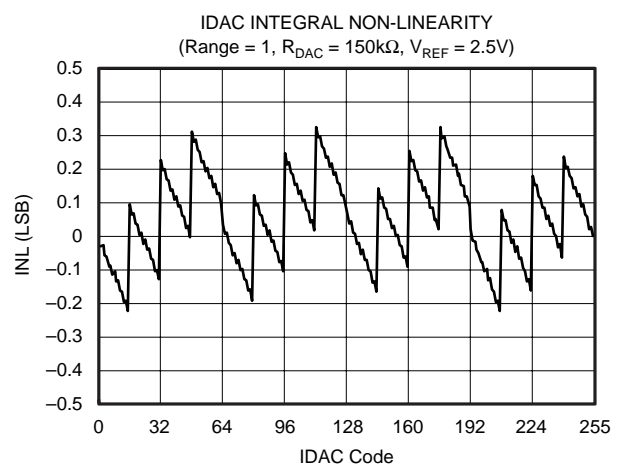
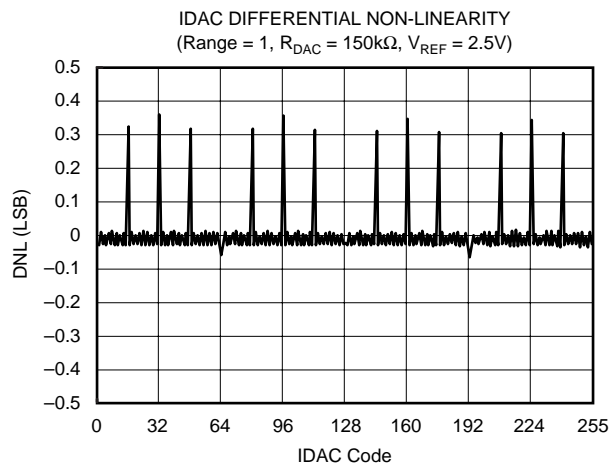
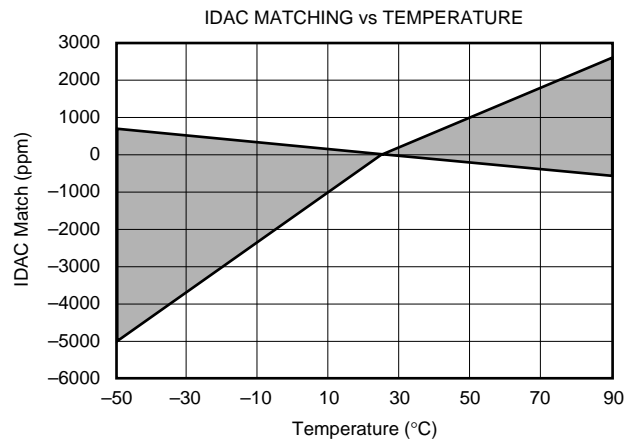
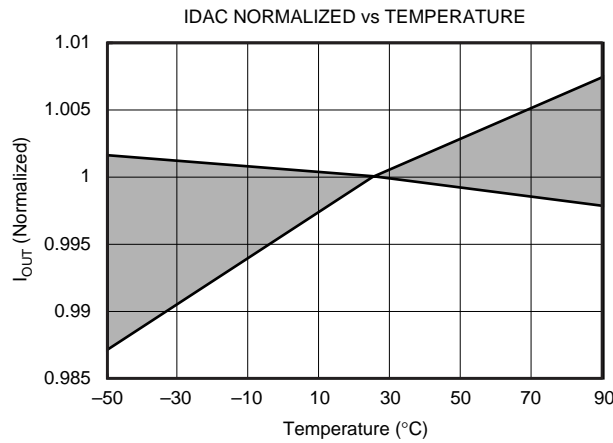
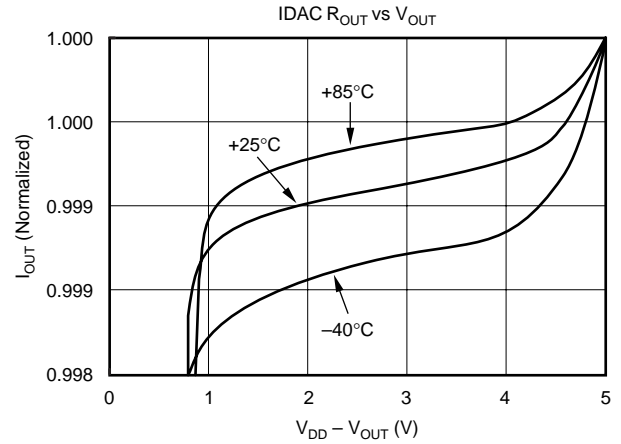
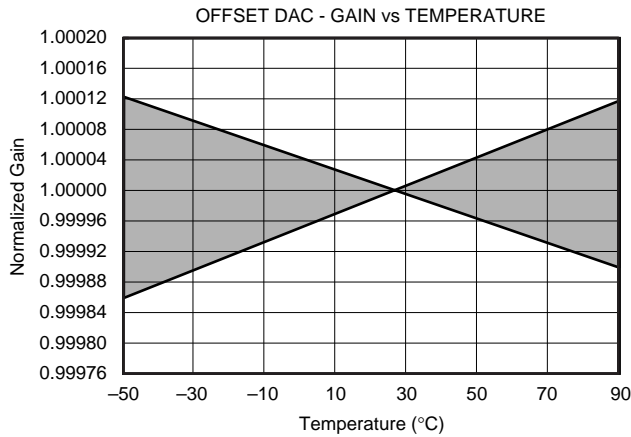

# OVERVIEW

## INPUT MULTIPLEXER

The input multiplexer provides for any combination of differential inputs to be selected on any of the input channels, as shown in Figure 1. If channel 1 is selected as the positive differential input channel, any other channel can be selected as the negative differential input channel. With this method, it is possible to have up to eight fully differential input channels.

In addition, current sources are supplied that will source or sink current to detect open or short circuits on the pins.

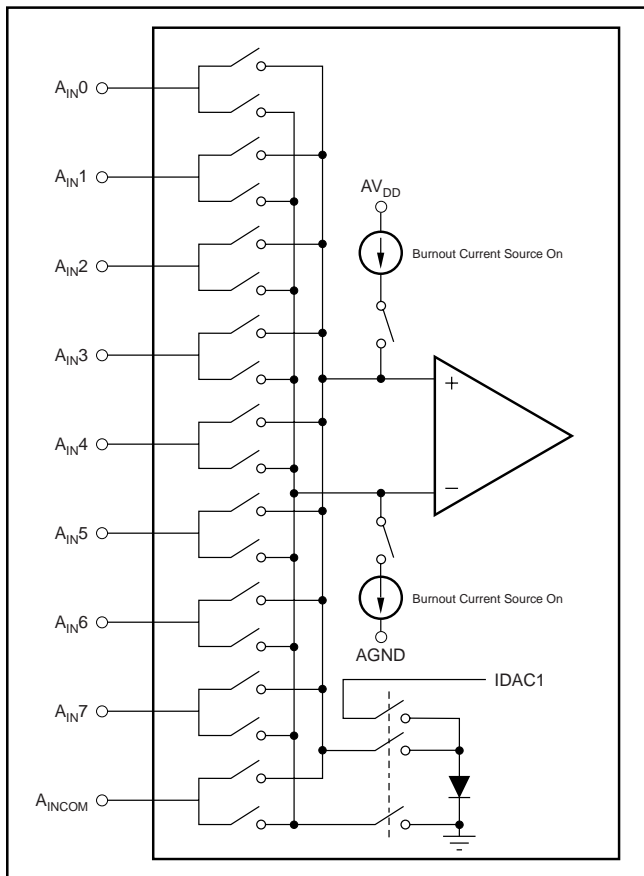

FIGURE 1. Input Multiplexer Configuration.

## TEMPERATURE SENSOR

An on-chip diode provides temperature sensing capability. When the configuration register for the input MUX is set to all 1s, the diode is connected to the input of the A/D converter. All other channels are open. The anode of the diode is connected to the positive input of the A/D converter, and the cathode of the diode is connected to negative input of the A/D converter. The output of IDAC1 is connected to the anode to bias the diode and the cathode of the diode is also connected to ground to complete the circuit.

In this mode, the output of IDAC1 is also connected to the output pin, so some current may flow into an external load from IDAC1, rather than the diode.

## BURNOUT CURRENT SOURCES

When the Burnout bit is set in the ACR configuration register, two current sources are enabled. The current source on the positive input channel sources approximately 2μA of current. The current source on the negative input channel sinks approximately 2μA. This allows for the detection of an open circuit (full-scale reading) or short circuit (0V differential reading) on the selected input differential pair.

## INPUT BUFFER

The input impedance of the ADS1216 without the buffer is 5MΩ/PGA. With the buffer enabled, the input voltage range is reduced and the analog power-supply current is higher. The buffer is controlled by ANDing the state of the buffer pin with the state of the BUFFER bit in the ACR register.

## IDAC1 AND IDAC2

The ADS1216 has two 8-bit current output DACs that can be controlled independently. The output current is set with  $R_{DAC}$ , the range select bits in the ACR register, and the 8-bit digital value in the IDAC register. The output current  $= V_{REF}/(8 \cdot R_{DAC})(2^{RANGE-1})(DAC CODE)$ . With  $V_{REFOUT} = 2.5V$  and  $R_{DAC} = 150k\Omega$ , the full-scale output can be selected to be 0.5, 1, or 2mA. The compliance voltage range is 0 to within 1V of  $AV_{DD}$ . When the internal voltage reference of the ADS1216 is used, it is the reference for the IDAC. An external reference may be used for the IDACs by disabling the internal reference and tying the external reference input to the  $V_{REFOUT}$  pin.

## PGA

The Programmable Gain Amplifier (PGA) can be set to gains of 1, 2, 4, 8, 16, 32, 64, or 128. Using the PGA can actually improve the effective resolution of the A/D converter. For instance, with a PGA of 1 on a 5V full-scale range, the A/D converter can resolve to 1μV. With a PGA of 128 on a 40mV full-scale range, the A/D converter can resolve to 75nV. With a PGA of 1 on a 5V full-scale range, it would require a 26-bit A/D converter to resolve 76nV.

## PGA OFFSET DAC

The input to the PGA can be shifted by half the full-scale input range of the PGA by using the ODAC register. The ODAC (Offset DAC) register is an 8-bit value; the MSB is the sign and the seven LSBs provide the magnitude of the offset. Using the ODAC does not reduce the performance of the A/D.

## MODULATOR

The modulator is a single-loop second-order system. The modulator runs at a clock speed ( $f_{MOD}$ ) that is derived from the external clock ( $f_{OSC}$ ). The frequency division is determined by the SPEED bit in the setup register.

SPEED BIT	$f_{MOD}$
0	$f_{OSC}/128$
1	$f_{OSC}/256$

## CALIBRATION

The offset and gain errors in the ADS1216, or the complete system, can be reduced with calibration. Internal calibration of the ADS1216 is called self calibration. This is handled with three commands. One command does both offset and gain calibration. There is also a gain calibration command and an offset calibration command. Each calibration process takes seven  $t_{DATA}$  periods to complete. Therefore, it takes 14  $t_{DATA}$  periods to complete both an offset and gain calibration.

For system calibration, the appropriate signal must be applied to the inputs. The system offset command requires a “zero” differential input signal. It then computes an offset that will nullify offset in the system. The system gain command requires a positive “full-scale” differential input signal. It then computes a value to nullify gain errors in the system. Each of these calibrations will take seven  $t_{DATA}$  periods to complete.

Calibration should be performed after power on, a change in temperature, or a change of the PGA. The RANGE bit (ACR bit 2) must be zero during calibration. For operation with a reference voltage greater than  $(AV_{DD} - 1.5)$  Volts, the buffer must also be turned off during calibration. Calibration will remove the effects of the ODAC, therefore, changes to the ODAC register must be done after calibration, otherwise the calibration will remove the effects of the offset.

At the completion of calibration the  $\overline{DRDY}$  signal goes low which indicates the calibration is finished and valid data is available.

## DIGITAL FILTER

The Digital Filter can use either the fast settling,  $\text{sinc}^2$ , or  $\text{sinc}^3$  filter, as shown in Figure 2. In addition, the Auto mode changes the sinc filter after the input channel or PGA is changed. When switching to a new channel, it will use the fast

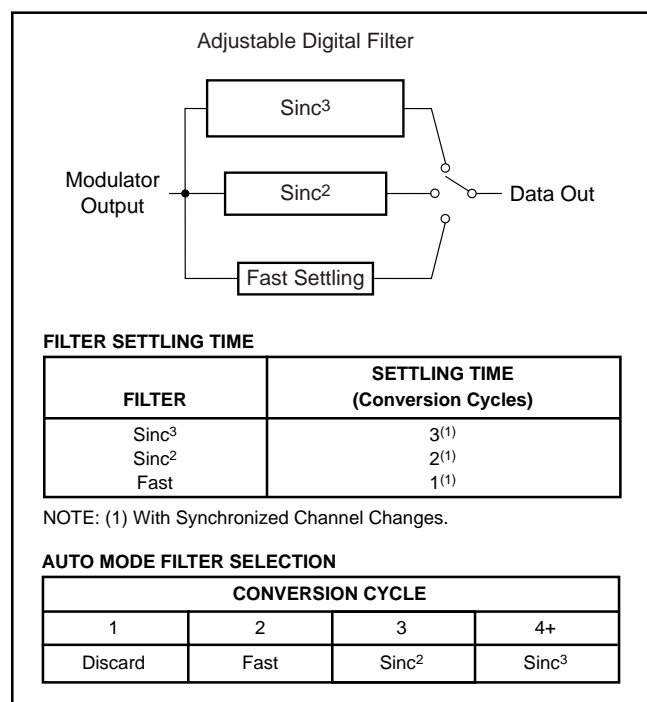

FIGURE 2. Filter Step Responses.

settling filter, for the next two conversions the first of which should be discarded. It will then use the  $\text{sinc}^2$  followed by the  $\text{sinc}^3$  filter to improve noise performance. This combines the low-noise advantage of the  $\text{sinc}^3$  filter with the quick response of the fast settling time filter. The frequency response of each filter is shown in Figure 3.

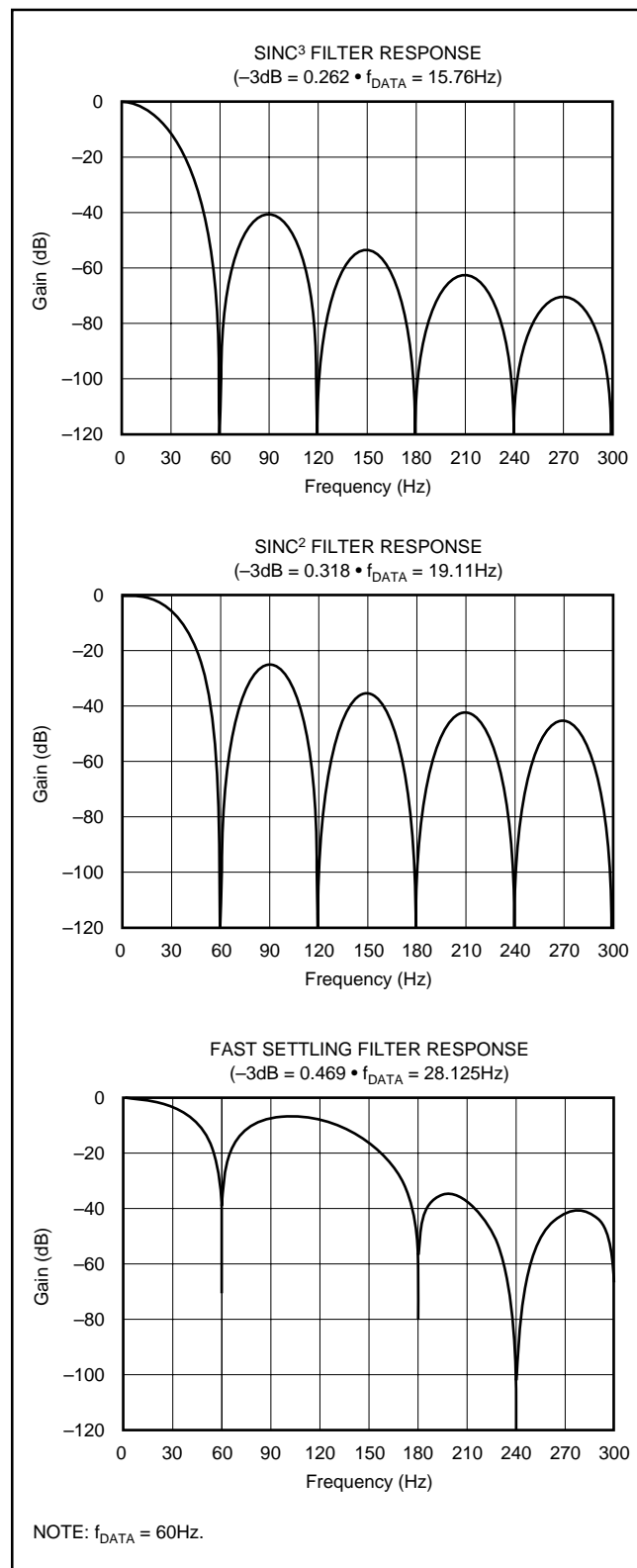

FIGURE 3. Filter Frequency Responses.

## VOLTAGE REFERENCE

The voltage reference used for the ADS1216 can either be internal or external. The power-up configuration for the voltage reference is 2.5V internal. The selection for the voltage reference is made through the status configuration register.

The internal voltage reference is selectable as either 1.25V or 2.5V ( $AV_{DD} = 5V$  only). The  $V_{REFOUT}$  pin should have a  $0.1\mu F$  capacitor to AGND.

The external voltage reference is differential and is represented by the voltage difference between the pins:  $+V_{REF}$  and  $-V_{REF}$ . The absolute voltage on either pin ( $+V_{REF}$  and  $-V_{REF}$ ) can range from AGND to  $AV_{DD}$ , however, the differential voltage must not exceed 2.5V. The differential voltage reference provides easy means of performing ratiometric measurement.

## $V_{RCAP}$ PIN

This pin provides a bypass cap for noise filtering on internal  $V_{REF}$  circuitry only. The recommended capacitor is a  $0.001\mu F$  ceramic cap. If an external  $V_{REF}$  is used, this pin can be left unconnected.

## CLOCK GENERATOR

The clock source for the ADS1216 can be provided from a crystal, ceramic resonator, oscillator, or external clock. When the clock source is a crystal or ceramic resonator, external capacitors must be provided to ensure start-up and a stable clock frequency. This is shown in Figure 4 and Table I.

## DIGITAL I/O INTERFACE

The ADS1216 has eight pins dedicated for digital I/O. The default power-up condition for the digital I/O pins are as inputs. All of the digital I/O pins are individually configurable

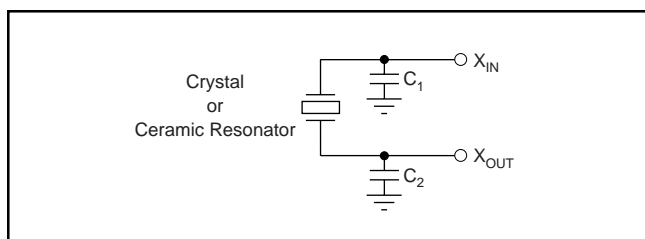

FIGURE 4. Crystal or Ceramic Resonator Connection.

CLOCK SOURCE	FREQUENCY	$C_1$	$C_2$	PART NUMBER
Crystal	2.4576	0-20pF	0-20pF	ECS, ECSD 2.45 - 32
Crystal	4.9152	0-20pF	0-20pF	ECS, ECSL 4.91
Crystal	4.9152	0-20pF	0-20pF	ECS, ECSD 4.91
Crystal	4.9152	0-20pF	0-20pF	CTS, MP 042 4M9182

TABLE I. Typical Clock Sources.

as inputs or outputs. They are configured through the DIR control register. The DIR register defines whether the pin is an input or output, and the DIO register defines the state of the digital output. When the digital I/O are configured as inputs, DIO is used to read the state of the pin.

## SERIAL INTERFACE

The serial interface is standard four-wire SPI compatible ( $D_{IN}$ ,  $D_{OUT}$ , SCLK, and  $\overline{CS}$ ). The ADS1216 also offers the flexibility to select the polarity of the serial clock through the POL pin. The serial interface can be clocked up to  $f_{OSC}/4$ .

Serial communication can occur independent of DRDY, DRDY only indicates the validity of data in the data output register.

## $\overline{DSYNC}$ OPERATION

$\overline{DSYNC}$  is used to provide for precise synchronization of the A/D conversion with an external event. Synchronization can be achieved either through the  $\overline{DSYNC}$  pin or the  $\overline{DSYNC}$  command. When the  $\overline{DSYNC}$  pin is used, the filter counter is reset on the falling edge of  $\overline{DSYNC}$ . The filter values are useless, they should be treated as if the input channel was changed. The modulator is held in reset until  $\overline{DSYNC}$  is taken HIGH. Synchronization occurs on the next rising edge of the system clock after  $\overline{DSYNC}$  is taken HIGH.

When the  $\overline{DSYNC}$  command is sent, the filter counter is reset on the edge of the last SCLK on the  $\overline{DSYNC}$  command. The modulator is held in RESET until the next edge of SCLK is detected. Synchronization occurs on the next rising edge of the system clock after the first SCLK after the  $\overline{DSYNC}$  command.

## POWER-UP—SUPPLY VOLTAGE RAMP RATE

The power-on reset circuitry was designed to accommodate digital supply ramp rates as slow as 1V/10ms. To ensure proper operation, the power supply should ramp monotonically.

## $\overline{RESET}$

There are three methods of reset. The  $\overline{RESET}$  pin, SCLK pattern, and the RESET command. They all perform the same function. The Power ON state also issues the RESET command.

## MEMORY

Two types of memory are used on the ADS1216: registers and RAM. 16 registers directly control the various functions (PGA, DAC value, Decimation Ratio, etc.) and can be directly read or written to. Collectively, the registers contain all the information needed to configure the part, such as data format, mux settings, calibration settings, decimation ratio, etc. Additional registers, such as output data, are accessed through dedicated instructions.

## ADS1216 REGISTER BANK TOPOLOGY

The operation of the device is set up through individual registers. The set of the 16 registers required to configure the device is referred to as a Register Bank, as shown in Figure 5.

Reads and Writes to Registers and RAM occur on a byte basis. However, copies between registers and RAM occurs on a bank basis. The RAM is independent of the Registers, i.e.: the RAM can be used as general-purpose RAM.

The ADS1216 supports any combination of eight analog inputs. With this flexibility, the device could easily support eight unique configurations—one per input channel. In order to facilitate this type of usage, eight separate register banks are available. Therefore, each configuration could be written once and recalled as needed without having to serially retransmit all the configuration data. Checksum commands are also included, which can be used to verify the integrity of RAM.

The RAM provides eight “banks”, with a bank consisting of 16 bytes. The total size of the RAM is 128 bytes. Copies between the registers and RAM are performed on a bank basis. Also, the RAM can be directly read or written through the serial interface on power-up. The banks allow separate storage of settings for each input.

The RAM address space is linear, therefore accessing RAM is done using an auto-incrementing pointer. Access to RAM in the entire memory map can be done consecutively without having to address each bank individually. For example, if you were currently accessing bank 0 at offset 0xF (the last location of bank 0), the next access would be bank 1 and offset 0x0. Any access after bank 7 and offset 0xF will wrap around to bank 0 and Offset 0x0.

Although the Register Bank memory is linear, the concept of addressing the device can also be thought of in terms of bank and offset addressing. Looking at linear and bank addressing syntax, we have the following comparison: in the linear

memory map, the address 0x14 is equivalent to bank 1 and offset 0x4. Simply stated, the most significant four bits represent the bank, and the least significant four bits represent the offset. The offset is equivalent to the register address for that bank of memory.

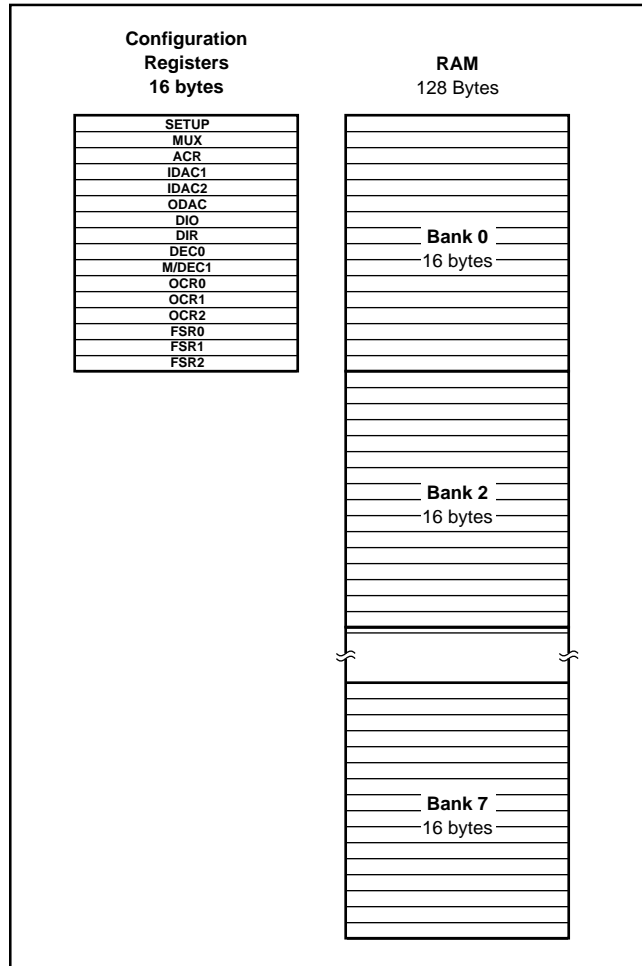

FIGURE 5. Memory Organization.

ADDRESS	REGISTER	BIT 7	BIT 6	BIT 5	BIT 4	BIT 3	BIT 2	BIT 1	BIT 0
00 <sub>H</sub>	SETUP	ID	ID	ID	SPEED	REF EN	REF HI	BUF EN	BIT ORDER
01 <sub>H</sub>	MUX	PSEL3	PSEL2	PSEL1	PSEL0	NSEL3	NSEL2	NSEL1	NSEL0
02 <sub>H</sub>	ACR	BOCS	IDAC2R1	IDAC2R0	IDAC1R1	IDAC1R0	PGA2	PGA1	PGA0
03 <sub>H</sub>	IDAC1	IDAC1_7	IDAC1_6	IDAC1_5	IDAC1_4	IDAC1_3	IDAC1_2	IDAC1_1	IDAC1_0
04 <sub>H</sub>	IDAC2	IDAC2_7	IDAC2_6	IDAC2_5	IDAC2_4	IDAC2_3	IDAC2_2	IDAC2_1	IDAC2_0
05 <sub>H</sub>	ODAC	SIGN	OSET_6	OSET_5	OSET_4	OSET_3	OSET_2	OSET_1	OSET_0
06 <sub>H</sub>	DIO	DIO_7	DIO_6	DIO_5	DIO_4	DIO_3	DIO_2	DIO_1	DIO_0
07 <sub>H</sub>	DIR	DIR_7	DIR_6	DIR_5	DIR_4	DIR_3	DIR_2	DIR_1	DIR_0
08 <sub>H</sub>	DEC0	DEC07	DEC06	DEC05	DEC04	DEC03	DEC02	DEC01	DEC00
09 <sub>H</sub>	M/DEC1	DRDY	U/B	SMODE1	SMODE0	Reserved	DEC10	DEC09	DEC08
0A <sub>H</sub>	OCR0	OCR07	OCR06	OCR05	OCR04	OCR03	OCR02	OCR01	OCR00
0B <sub>H</sub>	OCR1	OCR15	OCR14	OCR13	OCR12	OCR11	OCR10	OCR09	OCR08
0C <sub>H</sub>	OCR2	OCR23	OCR22	OCR21	OCR20	OCR19	OCR18	OCR17	OCR16
0D <sub>H</sub>	FSR0	FSR07	FSR06	FSR05	FSR04	FSR03	FSR02	FSR01	FSR00
0E <sub>H</sub>	FSR1	FSR15	FSR14	FSR13	FSR12	FSR11	FSR10	FSR09	FSR08
0F <sub>H</sub>	FSR2	FSR23	FSR22	FSR21	FSR20	FSR19	FSR18	FSR17	FSR16

TABLE II. Registers.

## DETAILED REGISTER DEFINITIONS

### SETUP (Address 00<sub>H</sub>) Setup Register

Reset Value = iii01110

bit 7	bit 6	bit 5	bit 4	bit 3	bit 2	bit 1	bit 0
ID	ID	ID	SPEED	REF EN	REF HI	BUF EN	BIT ORDER

bit 7-5 Factory Programmed Bits

bit 4 SPEED: Modulator Clock Speed

0 :  $f_{MOD} = f_{OSC}/128$  (default)

1 :  $f_{MOD} = f_{OSC}/256$

bit 3 REF EN: Internal Voltage Reference Enable

0 = Internal Voltage Reference Disabled

1 = Internal Voltage Reference Enabled (default)

bit 2 REF HI: Internal Reference Voltage Select

0 = Internal Reference Voltage = 1.25V

1 = Internal Reference Voltage = 2.5V (default)

bit 1 BUF EN: Buffer Enable

0 = Buffer Disabled

1 = Buffer Enabled (default)

bit 0 BIT ORDER: Set Order Bits are Transmitted

0 = Most Significant Bit Transmitted First (default)

1 = Least Significant Bit Transmitted First

Data is always shifted into the part most significant bit first. Data is always shifted out of the part most significant byte first. This configuration bit only controls the bit order within the byte of data that is shifted out.

### MUX (Address 01<sub>H</sub>) Multiplexer Control Register

Reset Value = 01<sub>H</sub>

bit 7	bit 6	bit 5	bit 4	bit 3	bit 2	bit 1	bit 0
PSEL3	PSEL2	PSEL1	PSEL0	NSEL3	NSEL2	NSEL1	NSEL0

bit 7-4 PSEL3: PSEL2: PSEL1: PSEL0: Positive Channel Select

0000 = AIN0 (default)

0001 = AIN1

0010 = AIN2

0011 = AIN3

0100 = AIN4

0101 = AIN5

0110 = AIN6

0111 = AIN7

1xxx = AINCOM (except when all bits are 1's)

1111 = Temperature Sensor Diode Anode

bit 3-0 NSEL3: NSEL2: NSEL1: NSEL0: Negative Channel Select

0000 = AIN0

0001 = AIN1 (default)

0010 = AIN2

0011 = AIN3

0100 = AIN4

0101 = AIN5

0110 = AIN6

0111 = AIN7

1xxx = AINCOM (except when all bits are 1's)

1111 = Temperature Sensor Diode Cathode Analog GND

### ACR (Address 02<sub>H</sub>) Analog Control Register

Reset Value = 00<sub>H</sub>

bit 7	bit 6	bit 5	bit 4	bit 3	bit 2	bit 1	bit 0
BOCS	IDAC2R1	IDAC2R0	IDAC1R1	IDAC1R0	PGA2	PGA1	PGA0

bit 7 BOCS: Burnout Current Source

0 = Disabled (default)

1 = Enabled

$$\text{IDAC Current} = \left( \frac{V_{REF}}{8 \cdot R_{DAC}} \right) (2^{\text{RANGE}-1}) (\text{DAC Code})$$

bit 6-5 IDAC2R1: IDAC2R0: Full-Scale Range Select for IDAC2

00 = Off (default)

01 = Range 1

10 = Range 2

11 = Range 3

bit 4-3 IDAC1R1: IDAC1R0: Full-Scale Range Select for IDAC1

00 = Off (default)

01 = Range 1

10 = Range 2

11 = Range 3

bit 2-0 PGA2: PGA1: PGA0: Programmable Gain Amplifier

Gain Selection

000 = 1 (default)

001 = 2

010 = 4

011 = 8

100 = 16

101 = 32

110 = 64

111 = 128

### IDAC1 (Address 03<sub>H</sub>) Current DAC 1

Reset Value = 00<sub>H</sub>

bit 7	bit 6	bit 5	bit 4	bit 3	bit 2	bit 1	bit 0
IDAC1_7	IDAC1_6	IDAC1_5	IDAC1_4	IDAC1_3	IDAC1_2	IDAC1_1	IDAC1_0

The DAC code bits set the output of DAC1 from 0 to full-scale. The value of the full-scale current is set by this Byte,  $V_{REF}$ ,  $R_{DAC}$ , and the DAC1 range bits in the ACR register.

### IDAC2 (Address 04<sub>H</sub>) Current DAC 2

Reset Value = 00<sub>H</sub>

bit 7	bit 6	bit 5	bit 4	bit 3	bit 2	bit 1	bit 0
IDAC2_7	IDAC2_6	IDAC2_5	IDAC2_4	IDAC2_3	IDAC2_2	IDAC2_1	IDAC2_0

The DAC code bits set the output of DAC2 from 0 to full-scale. The value of the full-scale current is set by this Byte,  $V_{REF}$ ,  $R_{DAC}$ , and the DAC2 range bits in the ACR register.



### ODAC (Address 05<sub>H</sub>) Offset DAC Setting

Reset Value = 00<sub>H</sub>

bit 7	bit 6	bit 5	bit 4	bit 3	bit 2	bit 1	bit 0
SIGN	OSET6	OSET5	OSET4	OSET3	OSET2	OSET1	OSET0

bit 7 Offset Sign  
 0 = Positive  
 1 = Negative

$$\text{bit 6-0 Offset} = \frac{V_{REF}}{2 \cdot PGA} \cdot \left( \frac{\text{Code}}{127} \right)$$

NOTE: The offset must be used after calibration or the calibration will notify the effects.

### DIO (Address 06<sub>H</sub>) Digital I/O Reset Value = 00<sub>H</sub>

bit 7	bit 6	bit 5	bit 4	bit 3	bit 2	bit 1	bit 0
DIO7	DIO6	DIO5	DIO4	DIO3	DIO2	DIO1	DIO0

A value written to this register will appear on the digital I/O pins if the pin is configured as an output in the DIR register. Reading this register will return the value of the digital I/O pins.

### DIR (Address 07<sub>H</sub>) Direction control for digital I/O

Reset Value = FF<sub>H</sub>

bit 7	bit 6	bit 5	bit 4	bit 3	bit 2	bit 1	bit 0
DIR7	DIR6	DIR5	DIR4	DIR3	DIR2	DIR1	DIR0

Each bit controls whether the Digital I/O pin is an output (= 0) or input (= 1). The default power-up state is as inputs.

### DEC0 (Address 08<sub>H</sub>) Decimation Register

(Least Significant 8 bits)

Reset Value = 80<sub>H</sub>

bit 7	bit 6	bit 5	bit 4	bit 3	bit 2	bit 1	bit 0
DEC07	DEC06	DEC05	DEC04	DEC03	DEC02	DEC01	DEC00

The decimation value is defined with 11 bits for a range of 20 to 2047. This register is the least significant 8 bits. The 3 most significant bits are contained in the M/DEC1 register. The default data rate is 10Hz with a 2.4576MHz crystal.

### M/DEC1 (Address 09<sub>H</sub>) Mode and Decimation Register

Reset Value = 07<sub>H</sub>

bit 7	bit 6	bit 5	bit 4	bit 3	bit 2	bit 1	bit 0
DRDY	U/B	SMODE1	SMODE0	Reserved	DEC10	DEC09	DEC08

bit 7 DRDY: Data Ready (Read Only)  
 This bit duplicates the state of the DRDY pin.

bit 6 U/B: Data Format  
 0 = Bipolar (default)  
 1 = Unipolar

U/B	ANALOG INPUT	DIGITAL OUTPUT
0	+FS	0x7FFFFFFF
	Zero	0x000000
	-FS	0x800000
1	+FS	0xFFFFFFFF
	Zero	0x000000
	-FS	0x000000

bit 5-4 SMODE1: SMODE0: Settling Mode

00 = Auto (default)  
 01 = Fast Settling filter  
 10 = Sinc<sup>2</sup> filter  
 11 = Sinc<sup>3</sup> filter

bit 2-0 DEC10: DEC09: DEC08: Most Significant Bits of the Decimation Value

### OCR0 (Address 0A<sub>H</sub>) Offset Calibration Coefficient

(Least Significant Byte)

Reset Value = 00<sub>H</sub>

bit 7	bit 6	bit 5	bit 4	bit 3	bit 2	bit 1	bit 0
OCR07	OCR06	OCR05	OCR04	OCR03	OCR02	OCR01	OCR00

### OCR1 (Address 0B<sub>H</sub>) Offset Calibration Coefficient

(Middle Byte)

Reset Value = 00<sub>H</sub>

bit 7	bit 6	bit 5	bit 4	bit 3	bit 2	bit 1	bit 0
OCR15	OCR14	OCR13	OCR12	OCR11	OCR10	OCR09	OCR08

### OCR2 (Address 0C<sub>H</sub>) Offset Calibration Coefficient

(Most Significant Byte)

Reset Value = 00<sub>H</sub>

bit 7	bit 6	bit 5	bit 4	bit 3	bit 2	bit 1	bit 0
OCR23	OCR22	OCR21	OCR20	OCR19	OCR18	OCR17	OCR16

### FSR0 (Address 0D<sub>H</sub>) Full-Scale Register

(Least Significant Byte)

Reset Value = 24<sub>H</sub>

bit 7	bit 6	bit 5	bit 4	bit 3	bit 2	bit 1	bit 0
FSR07	FSR06	FSR05	FSR04	FSR03	FSR02	FSR01	FSR00

### FSR1 (Address 0E<sub>H</sub>) Full-Scale Register

(Middle Byte)

Reset Value = 90<sub>H</sub>

bit 7	bit 6	bit 5	bit 4	bit 3	bit 2	bit 1	bit 0
FSR15	FSR14	FSR13	FSR12	FSR011	FSR10	FSR09	FSR08

### FSR2 (Address 0F<sub>H</sub>) Full-Scale Register

(Most Significant Byte)

Reset Value = 67<sub>H</sub>

bit 7	bit 6	bit 5	bit 4	bit 3	bit 2	bit 1	bit 0
FSR23	FSR22	FSR21	FSR20	FSR019	FSR18	FSR17	FSR16

# ADS1216 CONTROL

## COMMAND DEFINITIONS

The commands listed below control the operation of the ADS1216. Some of the commands are stand-alone commands (e.g., RESET) while others require additional bytes (e.g., WREG requires command, count, and the data bytes). Op codes that output data require a minimum of four  $f_{OSC}$  cycles before the data is ready (e.g., RDATA).

Operands:

n = count (0 to 127)

r = register (0 to 15)

x = don't care

a = RAM bank address (0 to 7)

COMMANDS	DESCRIPTION	COMMAND BYTE	2ND COMMAND BYTE
RDATA	Read Data	0000 0001 (01 <sub>H</sub> )	—
RDATA C	Read Data Continuously	0000 0011 (03 <sub>H</sub> )	—
STOPC	Stop Read Data Continuously	0000 1111 (0F <sub>H</sub> )	—
RREG	Read from REG Bank "rrrr"	0001 rrrr (1x <sub>H</sub> )	xxxx_nnnn (# of reg-1)
RRAM	Read from RAM Bank "aaa"	0010 0aaa (2x <sub>H</sub> )	xnnn_nnnn (# of bytes-1)
CREG	Copy REGs to RAM Bank "aaa"	0100 0aaa (4x <sub>H</sub> )	—
CREGA	Copy REGS to all RAM Banks	0100 1000 (48 <sub>H</sub> )	—
WREG	Write to REG "rrrr"	0101 rrrr (5x <sub>H</sub> )	xxxx_nnnn (# of reg-1)
WRAM	Write to RAM Bank "aaa"	0110 0aaa (6x <sub>H</sub> )	xnnn_nnnn (# of bytes-1)
CRAM	Copy RAM Bank "aaa" to REG	1100 0aaa (Cx <sub>H</sub> )	—
CSRAMX	Calc RAM Bank "aaa" Checksum	1101 0aaa (Dx <sub>H</sub> )	—
CSARAMX	Calc all RAM Bank Checksum	1101 1000 (D8 <sub>H</sub> )	—
CSREG	Calc REG Checksum	1101 1111 (DF <sub>H</sub> )	—
CSRAM	Calc RAM Bank "aaa" Checksum	1110 0aaa (Ex <sub>H</sub> )	—
CSARAM	Calc all RAM Banks Checksum	1110 1000 (E8 <sub>H</sub> )	—
SELF CAL	Self Cal Offset and Gain	1111 0000 (F0 <sub>H</sub> )	—
SELF CAL	Self Cal Offset	1111 0001 (F1 <sub>H</sub> )	—
SELF CAL	Self Cal Gain	1111 0010 (F2 <sub>H</sub> )	—
SYSOCAL	Sys Cal Offset	1111 0011 (F3 <sub>H</sub> )	—
SYSGCAL	Sys Cal Gain	1111 0100 (F4 <sub>H</sub> )	—
DSYNC	Sync $\overline{DRDY}$	1111 1100 (FC <sub>H</sub> )	—
SLEEP	Put in SLEEP Mode	1111 1101 (FD <sub>H</sub> )	—
RESET	Reset to Power-Up Values	1111 1110 (FE <sub>H</sub> )	—

NOTE: (1) The data received by the A/D is always MSB First, the data out format is set by the BIT ORDER bit in ACR reg.

TABLE III. Command Summary.

## RDATA Read Data

**Description:** Read a single data value from the Data Output Register (DOR) which is the most recent conversion result. This is a 24-bit value.

**Operands:** None

**Bytes:** 1

**Encoding:** 0000 0001

**Data Transfer Sequence:**

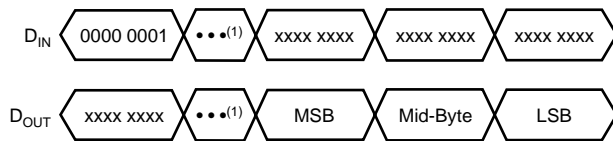

NOTE: (1) For wait time, refer to timing specification.

## RDATA C Read Data Continuous

**Description:** Read Data Continuous mode enables the continuous output of new data on each  $\overline{DRDY}$ . This command eliminates the need to send the Read Data Command on each  $\overline{DRDY}$ . This mode may be terminated by either the STOPC Read Continuous command or the RESET command.

**Operands:** None

**Bytes:** 1

**Encoding:** 0000 0011

**Data Transfer Sequence:**

Command terminated when "uuuu uuuu" equals STOPC or RESET.

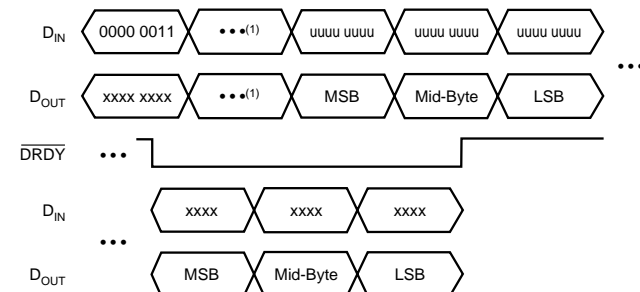

NOTE: (1) For wait time, refer to timing specification.

## STOPC Stop Continuous

**Description:** Ends the continuous data output mode.

**Operands:** None

**Bytes:** 1

**Encoding:** 0000 1111

**Data Transfer Sequence:**

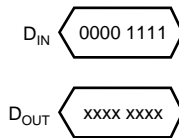

## RREG Read from Registers

**Description:** Output the data from up to 16 registers starting with the register address specified as part of the instruction. The number of registers read will be one plus the second byte. If the count exceeds the remaining registers, the addresses will wrap back to the beginning.

**Operands:** r, n

**Bytes:** 2

**Encoding:** 0001 rrrr xxxx nnnn

**Data Transfer Sequence:**

Read Two Registers Starting from Register 01<sub>H</sub> (MUX)



NOTE: (1) For wait time, refer to timing specification.

## RRAM Read from RAM

**Description:** Up to 128 bytes can be read from RAM starting at the bank specified in the op code. All reads start at the address for the beginning of the RAM bank. The number of bytes to read will be one plus the value of the second byte.

**Operands:** a, n

**Bytes:** 2

**Encoding:** 0010 0aaa xnnn nnnn

**Data Transfer Sequence:**

Read Two RAM Locations Starting from 20<sub>H</sub>



NOTE: (1) For wait time, refer to timing specification.

## CREG Copy Registers to RAM Bank

**Description:** Copy the 16 control registers to the RAM bank specified in the op code. Refer to timing specifications for command execution time.

**Operands:** a

**Bytes:** 1

**Encoding:** 0100 0aaa

**Data Transfer Sequence:**

Copy Register Values to RAM Bank 3

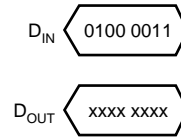

## CREGA Copy Registers to All RAM Banks

**Description:** Duplicate the 16 control registers to all the RAM banks. Refer to timing specifications for command execution time.

**Operands:** None

**Bytes:** 1

**Encoding:** 0100 1000

**Data Transfer Sequence:**

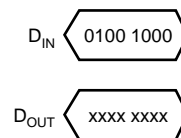

## WREG Write to Register

**Description:** Write to the registers starting with the register specified as part of the instruction. The number of registers that will be written is one plus the value of the second byte.

**Operands:** r, n

**Bytes:** 2

**Encoding:** 0101 rrrr xxxx nnnn

**Data Transfer Sequence:**

Write Two Registers Starting from 06<sub>H</sub> (DIO)



## WRAM Write to RAM

**Description:** Write up to 128 RAM locations starting at the beginning of the RAM bank specified as part of the instruction. The number of bytes written to RAM is one plus the value of the second byte.

**Operands:** a, n

**Bytes:** 2

**Encoding:** 0110 0aaa xnnn nnnn

**Data Transfer Sequence:**

Write to Two RAM Locations starting from 10<sub>H</sub>

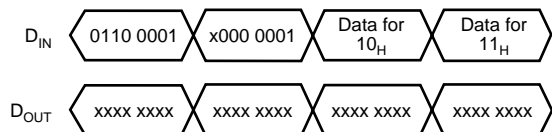

## CRAM Copy RAM Bank to Registers

**Description:** Copy the selected RAM Bank to the Configuration Registers. This will overwrite all of the registers with the data from the RAM bank.

**Operands:** a

**Bytes:** 1

**Encoding:** 1100 0aaa

**Data Transfer Sequence:**

Copy RAM Bank 0 to the Registers

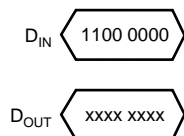

## CSRAMX Calculate RAM Bank Checksum

**Description:** Calculate the checksum of the selected RAM Bank. The checksum is calculated as a sum of all the bytes with the carry ignored. The ID,  $\overline{DRDY}$  and DIO bits are masked so they are not included in the checksum.

**Operands:** a

**Bytes:** 1

**Encoding:** 1101 0aaa

**Data Transfer Sequence:**

Calculate Checksum for RAM Bank 3

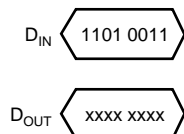

## CSARAMX Calculate the Checksum for all RAM Banks

**Description:** Calculate the checksum of all RAM Banks. The checksum is calculated as a sum of all the bytes with the carry ignored. The ID,  $\overline{DRDY}$  and DIO bits are masked so they are not included in the checksum.

**Operands:** None

**Bytes:** 1

**Encoding:** 1101 1000

**Data Transfer Sequence:**

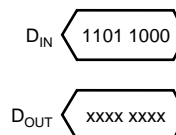

## CSREG Calculate the Checksum of Registers

**Description:** Calculate the checksum of all the registers. The checksum is calculated as a sum of all the bytes with the carry ignored. The ID,  $\overline{DRDY}$  and DIO bits are masked so they are not included in the checksum.

**Operands:** None

**Bytes:** 1

**Encoding:** 1101 1111

**Data Transfer Sequence:**

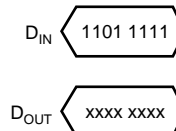

## CSRAM Calculate RAM Bank Checksum

**Description:** Calculate the checksum of the selected RAM Bank. The checksum is calculated as a sum of all the bytes with the carry ignored. All bits are included in the checksum calculation, there is no masking of bits.

**Operands:** a

**Bytes:** 1

**Encoding:** 1110 0aaa

**Data Transfer Sequence:**

Calculate Checksum for RAM Bank 2

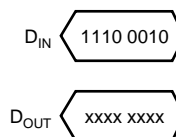

## CSARAM Calculate Checksum for all RAM Banks

**Description:** Calculate the checksum of all RAM Banks. The checksum is calculated as a sum of all the bytes with the carry ignored. All bits are included in the checksum calculation, there is no masking of bits.

**Operands:** None

**Bytes:** 1

**Encoding:** 1110 1000

**Data Transfer Sequence:**

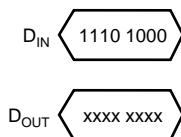

## SELFCAL Offset and Gain Self Calibration

**Description:** Starts the process of self calibration. The Offset Control Register (OCR) and the Full-Scale Register (FSR) are updated with new values after this operation.

**Operands:** None

**Bytes:** 1

**Encoding:** 1111 0000

**Data Transfer Sequence:**

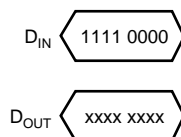

## SELFOCAL Offset Self Calibration

**Description:** Starts the process of self-calibration for offset. The Offset Control Register (OCR) is updated after this operation.

**Operands:** None

**Bytes:** 1

**Encoding:** 1111 0001

**Data Transfer Sequence:**

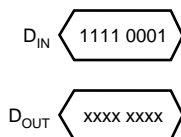

## SELFGCAL Gain Self Calibration

**Description:** Starts the process of self-calibration for gain. The Full-Scale Register (FSR) is updated with new values after this operation.

**Operands:** None

**Bytes:** 1

**Encoding:** 1111 0010

**Data Transfer Sequence:**

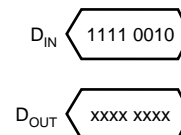

## SYSOCAL System Offset Calibration

**Description:** Starts the system offset calibration process. For a system offset calibration the input should be set to 0V differential, and the ADS1216 computes the OCR register value that will compensate for offset errors. The Offset Control Register (OCR) is updated after this operation.

**Operands:** None

**Bytes:** 1

**Encoding:** 1111 0011

**Data Transfer Sequence:**

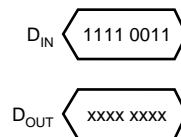

## SYSGCAL System Gain Calibration

**Description:** Starts the system gain calibration process. For a system gain calibration, the differential input should be set to the reference voltage and the ADS1216 computes the FSR register value that will compensate for gain errors. The FSR is updated after this operation.

**Operands:** None

**Bytes:** 1

**Encoding:** 1111 0100

**Data Transfer Sequence:**



## DSYNC Sync DRDY

**Description:** Synchronizes the ADS1216 to the serial clock edge.

**Operands:** None

**Bytes:** 1

**Encoding:** 1111 1100

**Data Transfer Sequence:**

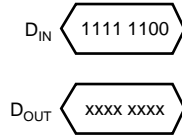

## RESET Reset to Powerup Values

**Description:** Restore the registers to their power-up values. This command will also stop the Read Continuous mode. It does not affect the contents of RAM.

**Operands:** None

**Bytes:** 1

**Encoding:** 1111 1110

**Data Transfer Sequence:**

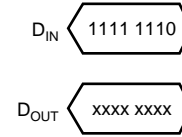

## SLEEP Sleep Mode

**Description:** Puts the ADS1216 into a low power sleep mode. To exit sleep mode strobe SCLK.

**Operands:** None

**Bytes:** 1

**Encoding:** 1111 1101

**Data Transfer Sequence:**

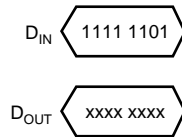

MSB	LSB															
	0000	0001	0010	0011	0100	0101	0110	0111	1000	1001	1010	1011	1100	1101	1110	1111
0000	x	rdata	x	rdatac	x	x	x	x	x	x	x	x	x	x	x	stopc
0001	rreg 0	rreg 1	rreg 2	rreg 3	rreg 4	rreg 5	rreg 6	rreg 7	rreg 8	rreg 9	rreg A	rreg B	rreg C	rreg D	rreg E	rreg F
0010	rram 0	rram 1	rram 2	rram 3	rram 4	rram 5	rram 6	rram 7	x	x	x	x	x	x	x	x
0011	x	x	x	x	x	x	x	x	x	x	x	x	x	x	x	x
0100	creg 0	creg 1	creg 2	creg 3	creg 4	creg 5	creg 6	creg 7	crega	x	x	x	x	x	x	x
0101	wreg 0	wreg 1	wreg 2	wreg 3	wreg 4	wreg 5	wreg 6	wreg 7	wreg 8	wreg 9	wreg A	wreg B	wreg C	wreg D	wreg E	wreg F
0110	wram 0	wram 1	wram 2	wram 3	wram 4	wram 5	wram 6	wram 7	x	x	x	x	x	x	x	x
0111	x	x	x	x	x	x	x	x	x	x	x	x	x	x	x	x
1000	x	x	x	x	x	x	x	x	x	x	x	x	x	x	x	x
1001	x	x	x	x	x	x	x	x	x	x	x	x	x	x	x	x
1010	x	x	x	x	x	x	x	x	x	x	x	x	x	x	x	x
1011	x	x	x	x	x	x	x	x	x	x	x	x	x	x	x	x
1100	cram 0	cram 1	cram 2	cram 3	cram 4	cram 5	cram 6	cram 7	x	x	x	x	x	x	x	x
1101	csramx 0	csramx 1	csramx 2	csramx 3	csramx 4	csramx 5	csramx 6	csramx 7	csa ramx	x	x	x	x	x	x	csreg
1110	cs ram 0	cs ram 1	cs ram 2	cs ram 3	cs ram 4	cs ram 5	cs ram 6	cs ram 7	csa ram	x	x	x	x	x	x	x
1111	self cal	self ocal	self gcal	sys ocal	sys gcal	x	x	x	x	x	x	x	dsync	sleep	reset	x

x = Reserved

TABLE IV. Command Map.

## SERIAL PERIPHERAL INTERFACE

The Serial Peripheral Interface (SPI), allows a controller to communicate synchronously with the ADS1216. The ADS1216 operates in slave only mode.

### SPI Transfer Formats

During an SPI transfer, data is simultaneously transmitted and received. The SCLK signal synchronizes shifting and sampling of the information on the two serial data lines:  $D_{IN}$  and  $D_{OUT}$ . The  $\overline{CS}$  signal allows individual selection of an ADS1216 device; an ADS1216 with  $\overline{CS}$  HIGH is not active on the bus.

### Clock Phase and Polarity Controls (POL)

The clock polarity is specified by the POL pin, which selects an active HIGH or active LOW clock, and has no effect on the transfer format.

### Serial Clock (SCLK)

SCLK, a Schmitt Trigger input to the ADS1216, is generated by the master device and synchronizes data transfer on the  $D_{IN}$  and  $D_{OUT}$  lines. When transferring data to or from the ADS1216, burst mode may be used i.e., multiple bits of data may be transferred back-to-back with no delay in SCLKs or toggling of  $\overline{CS}$ .

### Chip Select ( $\overline{CS}$ )

The chip select ( $\overline{CS}$ ) input of the ADS1216 must be externally asserted before a master device can exchange data with the ADS1216.  $\overline{CS}$  must be LOW before data transactions and must stay LOW for the duration of the transaction.

## DIGITAL INTERFACE

The ADS1216's programmable functions are controlled using a set of on-chip registers, as outlined previously. Data is written to these registers via the part's serial interface and read access to the on-chip registers is also provided by this interface.

The ADS1216's serial interface consists of four signals:  $\overline{CS}$ , SCLK,  $D_{IN}$ , and  $D_{OUT}$ . The  $D_{IN}$  line is used for transferring data into the on-chip registers while the  $D_{OUT}$  line is used for accessing data from the on-chip registers. SCLK is the serial clock input for the device and all data transfers (either on  $D_{IN}$  or  $D_{OUT}$ ) take place with respect to this SCLK signal.

The  $\overline{DRDY}$  line is used as a status signal to indicate when data is ready to be read from the ADS1216's data register.  $\overline{DRDY}$  goes LOW when a new data word is available in the DOR register. It is reset HIGH when a read operation from the data register is complete. It also goes HIGH prior to the updating of the output register to indicate when not to read from the device to ensure that a data read is not attempted while the register is being updated.

$\overline{CS}$  is used to select the device. It can be used to decode the ADS1216 in systems where a number of parts are connected to the serial bus.

The timing specification shows the timing diagram for interfacing to the ADS1216 with  $\overline{CS}$  used to decode the part.

The ADS1216 serial interface can operate in three-wire mode by tying the  $\overline{CS}$  input LOW. In this case, the SCLK,  $D_{IN}$ , and  $D_{OUT}$  lines are used to communicate with the ADS1216 and the status of  $\overline{DRDY}$  can be obtained by interrogating bit 7 of the M/DEC1 register. This scheme is suitable for interfacing to microcontrollers. If  $\overline{CS}$  is required as a decoding signal, it can be generated from a port pin.

## DEFINITION OF TERMS

**Analog Input Voltage**—the voltage at any one analog input relative to AGND.

**Analog Input Differential Voltage**—given by the following equation:  $(IN+ - IN-)$ . Thus, a positive digital output is produced whenever the analog input differential voltage is positive, while a negative digital output is produced whenever the differential is negative.

For example, when the converter is configured with a 2.5V reference and placed in a gain setting of 1, the positive full-scale output is produced when the analog input differential is 2.5V. The negative full-scale output is produced when the differential is -2.5V. In each case, the actual input voltages must remain within the AGND to  $AV_{DD}$  range.

**Conversion Cycle**—the term “conversion cycle” usually refers to a discrete A/D conversion operation, such as that performed by a successive approximation converter. As used here, a conversion cycle refers to the  $t_{DATA}$  time period. However, each digital output is actually based on the modulator results from several  $t_{DATA}$  time periods.

FILTER SETTING	MODULATOR RESULTS
fast settling	1 $t_{DATA}$ time period
sinc <sup>2</sup>	2 $t_{DATA}$ time period
sinc <sup>3</sup>	3 $t_{DATA}$ time period

**Data Rate**—The rate at which conversions are completed. See definition for  $f_{DATA}$ .

**Decimation Ratio**—defines the ratio between the output of the modulator and the output Data Rate. Valid values for the Decimation Ratio are from 20 to 2047. Larger Decimation Ratios will have lower noise and vice-versa.

**Effective Resolution**—the effective resolution of the ADS1216 in a particular configuration can be expressed in two different units: bits rms (referenced to output) and  $V_{rms}$  (referenced to input). Computed directly from the converter's output data, each is a statistical calculation. The conversion from one to the other is shown below.

“Effective number of bits” (ENOB) or “effective resolution” is commonly used to define the usable resolution of the A/D converter. It is calculated from empirical data taken directly from the device. It is typically determined by applying a fixed known signal source to the analog input and computing the standard deviation of the data sample set. The rms noise defines the  $\pm\sigma$  interval about the sample mean (which implies that 95% of the data values fall within this range) and the peak-to-peak noise defines the  $\pm 3\sigma$  interval about the sample mean (which implies that 99.6% of the data values fall within this range).

The data from the A/D converter is output as codes, which then can be easily converted to other units, such as ppm or volts. The equations and table below show the relationship between bits or codes, ppm, and volts.

$$ENOB = \frac{-20 \log(\text{ppm})}{6.02}$$

BITS rms	BIPOLAR $V_{rms}$	UNIPOLAR $V_{rms}$
	$\frac{\left(\frac{2 \cdot V_{REF}}{PGA}\right)}{10^{\left(\frac{6.02 \cdot ER}{20}\right)}}$	$\frac{\left(\frac{V_{REF}}{PGA}\right)}{10^{\left(\frac{6.02 \cdot ER}{20}\right)}}$
24	298nV	149nV
22	1.19 $\mu$ V	597nV
20	4.77 $\mu$ V	2.39 $\mu$ V
18	19.1 $\mu$ V	9.55 $\mu$ V
16	76.4 $\mu$ V	38.2 $\mu$ V
14	505 $\mu$ V	152.7 $\mu$ V
12	1.22mV	610 $\mu$ V

**Filter Selection**—the ADS1216 uses a (sinc/x) filter or sinc filter. Actually there are three different sinc filters that can be selected. A fast settling filter will settle in one  $t_{DATA}$  cycle. The sinc<sup>2</sup> filter will settle in two cycles and have lower noise. The sinc<sup>3</sup> will achieve lowest noise and higher number of effective bits, but requires three cycles to settle. The ADS1216 will operate with any one of these filters, or it can operate in an auto mode, where it will select the fast settling filter after a new channel is selected and will then switch to sinc<sup>2</sup> followed by sinc<sup>3</sup>. This allows fast settling response and still achieves low noise after the necessary number of  $t_{DATA}$  cycles.

$f_{OSC}$ —the frequency of the crystal oscillator or CMOS compatible input signal at the  $X_{IN}$  input of the ADS1216.

$f_{MOD}$ —the frequency or speed at which the modulator of the ADS1216 is running. This depends on the SPEED bit as given by the following equation:

	SPEED = 0	SPEED = 1
mfactor	128	256

$$f_{MOD} = \frac{f_{OSC}}{\text{mfactor}}$$

$f_{SAMP}$ —the frequency, or switching speed, of the input sampling capacitor. The value is given by one of the following equations:

PGA SETTING	SAMPLING FREQUENCY
1, 2, 4, 8	$f_{SAMP} = \frac{f_{OSC}}{\text{mfactor}}$
16	$f_{SAMP} = \frac{f_{OSC} \cdot 2}{\text{mfactor}}$
32	$f_{SAMP} = \frac{f_{OSC} \cdot 4}{\text{mfactor}}$
64, 128	$f_{SAMP} = \frac{f_{OSC} \cdot 8}{\text{mfactor}}$

$f_{DATA}$ —the frequency of the digital output data produced by the ADS1216,  $f_{DATA}$  is also referred to as the Data Rate.

$$f_{DATA} = \left( \frac{f_{MOD}}{\text{Decimation Ratio}} \right) = \left( \frac{f_{OSC}}{\text{mfactor} \cdot \text{Decimation Ratio}} \right)$$

**Full-Scale Range (FSR)**—as with most A/D converters, the full-scale range of the ADS1216 is defined as the “input”, which produces the positive full-scale digital output minus the “input”, which produces the negative full-scale digital output. The full-scale range changes with gain setting as shown in Table V.

For example, when the converter is configured with a 2.5V reference and is placed in a gain setting of 2, the full-scale range is: [1.25V (positive full-scale) minus -1.25V (negative full-scale)] = 2.5V.

**Least Significant Bit (LSB) Weight**—this is the theoretical amount of voltage that the differential voltage at the analog input would have to change in order to observe a change in the output data of one least significant bit. It is computed as follows:

$$\text{LSB Weight} = \frac{\text{Full-Scale Range}}{2^N}$$

where N is the number of bits in the digital output.

$t_{DATA}$ —the inverse of  $f_{DATA}$ , or the period between each data output.



GAIN SETTING	5V SUPPLY ANALOG INPUT <sup>(1)</sup>			GENERAL EQUATIONS		
	FULL-SCALE RANGE	DIFFERENTIAL INPUT VOLTAGES <sup>(2)</sup>	PGA OFFSET RANGE	FULL-SCALE RANGE	DIFFERENTIAL INPUT VOLTAGES <sup>(2)</sup>	PGA SHIFT RANGE
1	5V	±2.5V	±1.25V	$\frac{2 \cdot V_{REF}}{PGA}$	$\frac{\pm V_{REF}}{PGA}$	$\frac{\pm V_{REF}}{2 \cdot PGA}$
2	2.5V	±1.25V	±0.625V			
4	1.25V	±0.625V	±312.5mV			
8	0.625V	±312.5mV	±156.25mV			
16	312.5mV	±156.25mV	±78.125mV			
32	156.25mV	±78.125mV	±39.0625mV			
64	78.125mV	±39.0625mV	±19.531mV			
128	39.0625mV	±19.531mV	±9.766mV			

NOTES: (1) With a 2.5V reference. (2) The ADS1216 allows common-mode voltage as long as the absolute input voltage on A<sub>INP</sub> or A<sub>INN</sub> does not go below AGND or above AV<sub>DD</sub>.

TABLE V. Full-Scale Range versus PGA Setting.

# TOPIC INDEX

TOPIC	PAGE
ABSOLUTE MAXIMUM RATINGS .....	2
PACKAGE/ORDERING INFORMATION .....	2
ELECTRICAL CHARACTERISTICS ( $V_{DD} = 5V$ ) .....	2-3
ELECTRICAL CHARACTERISTICS ( $V_{DD} = 3V$ ) .....	4-5
PIN CONFIGURATION .....	6
TIMING CHARACTERISTICS .....	7
TYPICAL CHARACTERISTICS .....	8-11
OVERVIEW .....	12
MEMORY .....	14
ADS1216 REGISTER BANK TOPOLOGY .....	15
DETAILED REGISTER DEFINITIONS .....	16-17
COMMAND DEFINITIONS .....	18-22
ADS1216 COMMAND MAP .....	22
SERIAL PERIPHERAL INTERFACE .....	23
DIGITAL INTERFACE .....	23
DEFINITION OF TERMS .....	23-24

PFB (S-PQFP-G48)

PLASTIC QUAD FLATPACK

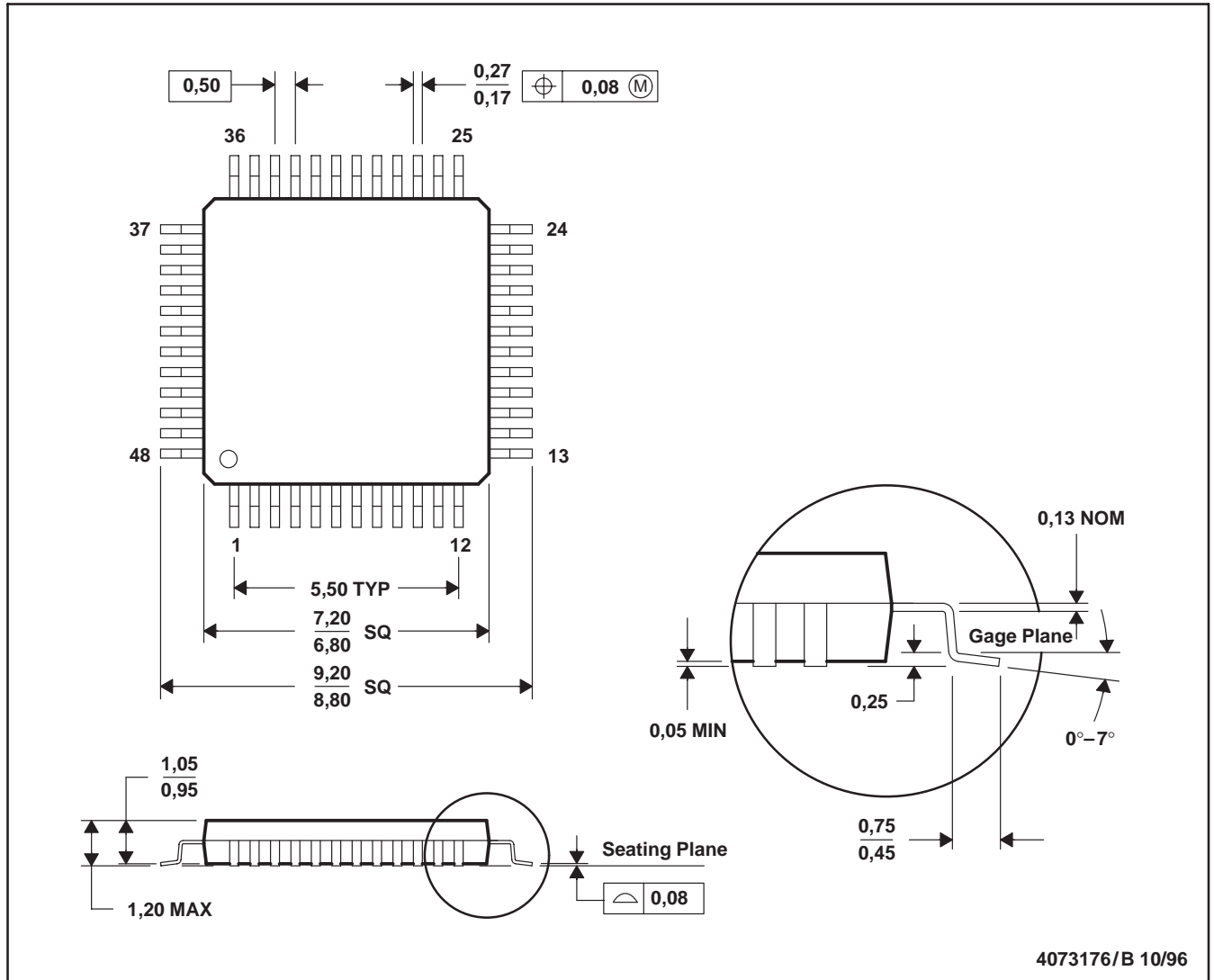

- NOTES: A. All linear dimensions are in millimeters.  
 B. This drawing is subject to change without notice.  
 C. Falls within JEDEC MS-026

## IMPORTANT NOTICE

Texas Instruments Incorporated and its subsidiaries (TI) reserve the right to make corrections, modifications, enhancements, improvements, and other changes to its products and services at any time and to discontinue any product or service without notice. Customers should obtain the latest relevant information before placing orders and should verify that such information is current and complete. All products are sold subject to TI's terms and conditions of sale supplied at the time of order acknowledgment.

TI warrants performance of its hardware products to the specifications applicable at the time of sale in accordance with TI's standard warranty. Testing and other quality control techniques are used to the extent TI deems necessary to support this warranty. Except where mandated by government requirements, testing of all parameters of each product is not necessarily performed.

TI assumes no liability for applications assistance or customer product design. Customers are responsible for their products and applications using TI components. To minimize the risks associated with customer products and applications, customers should provide adequate design and operating safeguards.

TI does not warrant or represent that any license, either express or implied, is granted under any TI patent right, copyright, mask work right, or other TI intellectual property right relating to any combination, machine, or process in which TI products or services are used. Information published by TI regarding third-party products or services does not constitute a license from TI to use such products or services or a warranty or endorsement thereof. Use of such information may require a license from a third party under the patents or other intellectual property of the third party, or a license from TI under the patents or other intellectual property of TI.

Reproduction of information in TI data books or data sheets is permissible only if reproduction is without alteration and is accompanied by all associated warranties, conditions, limitations, and notices. Reproduction of this information with alteration is an unfair and deceptive business practice. TI is not responsible or liable for such altered documentation.

Resale of TI products or services with statements different from or beyond the parameters stated by TI for that product or service voids all express and any implied warranties for the associated TI product or service and is an unfair and deceptive business practice. TI is not responsible or liable for any such statements.

Following are URLs where you can obtain information on other Texas Instruments products and application solutions:

<b>Products</b>		<b>Applications</b>	
Amplifiers	<a href="http://amplifier.ti.com">amplifier.ti.com</a>	Audio	<a href="http://www.ti.com/audio">www.ti.com/audio</a>
Data Converters	<a href="http://dataconverter.ti.com">dataconverter.ti.com</a>	Automotive	<a href="http://www.ti.com/automotive">www.ti.com/automotive</a>
DSP	<a href="http://dsp.ti.com">dsp.ti.com</a>	Broadband	<a href="http://www.ti.com/broadband">www.ti.com/broadband</a>
Interface	<a href="http://interface.ti.com">interface.ti.com</a>	Digital Control	<a href="http://www.ti.com/digitalcontrol">www.ti.com/digitalcontrol</a>
Logic	<a href="http://logic.ti.com">logic.ti.com</a>	Military	<a href="http://www.ti.com/military">www.ti.com/military</a>
Power Mgmt	<a href="http://power.ti.com">power.ti.com</a>	Optical Networking	<a href="http://www.ti.com/opticalnetwork">www.ti.com/opticalnetwork</a>
Microcontrollers	<a href="http://microcontroller.ti.com">microcontroller.ti.com</a>	Security	<a href="http://www.ti.com/security">www.ti.com/security</a>
		Telephony	<a href="http://www.ti.com/telephony">www.ti.com/telephony</a>
		Video & Imaging	<a href="http://www.ti.com/video">www.ti.com/video</a>
		Wireless	<a href="http://www.ti.com/wireless">www.ti.com/wireless</a>

Mailing Address: Texas Instruments  
Post Office Box 655303 Dallas, Texas 75265

Copyright © 2004, Texas Instruments Incorporated