

NCV8450

Self-Protected High Side Driver with Temperature and Current Limit

The NCV8450 is a fully protected High-Side Smart Discrete device with a typical $R_{DS(on)}$ of $1.0\ \Omega$ and an internal current limit of $0.8\ A$ typical. The device can switch a wide variety of resistive, inductive, and capacitive loads.

Features

- Short Circuit Protection
- Thermal Shutdown with Automatic Restart
- Overvoltage Protection
- Integrated Clamp for Inductive Switching
- Loss of Ground Protection
- ESD Protection
- Slew Rate Control for Low EMI
- Very Low Standby Current
- AEC-Q100/101 qualified
- This is a Pb-Free Device

Typical Applications

- Automotive
- Industrial

PRODUCT SUMMARY

Symbol	Characteristics	Value	Unit
V_{IN_CL}	Overvoltage Protection	54	V
$V_{D(on)}$	Operation Voltage	4.5 – 45	V
R_{on}	On-State Resistance	1.0	Ω



ON Semiconductor®

<http://onsemi.com>

MARKING DIAGRAM



SOT-223
(TO-261)
CASE 318E

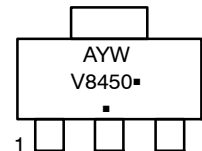

A = Assembly Location
Y = Year
W = Work Week
▪ = Pb-Free Package

(Note: Microdot may be in either location)

ORDERING INFORMATION

See detailed ordering and shipping information in the package dimensions section on page 8 of this data sheet.

NCV8450

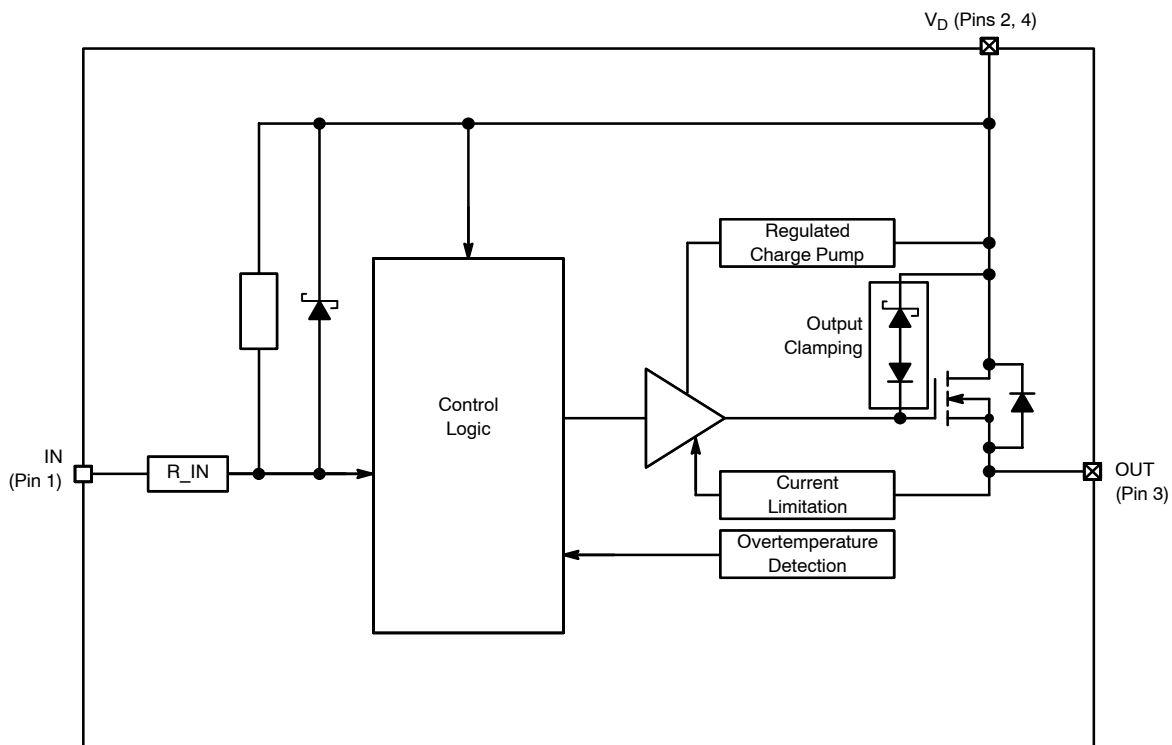

Figure 1. Block Diagram

PACKAGE PIN DESCRIPTION

Pin #	Symbol	Description
1	IN	Control Input, Active Low
2	V_D	Supply Voltage
3	OUT	Output
4	V_D	Supply Voltage

NCV8450

MAXIMUM RATINGS

Rating	Symbol	Value		Unit
		Min	Max	
DC Supply Voltage (Note 1)	V_D	-16	45	V
Load Dump Protection ($R_I = 2 \Omega$, $t_d = 400 \text{ ms}$, $V_{IN} = 0, 10 \text{ V}$, $I_L = 150 \text{ mA}$, $V_{bb} = 13.5 \text{ V}$)	V_{Loaddump}		100	V
Input Current	I_{in}	-15	15	mA
Output Current (Note 1)	I_{out}		Internally Limited	A
Total Power Dissipation @ $T_A = 25^\circ\text{C}$ (Note 2) @ $T_A = 25^\circ\text{C}$ (Note 3)	P_D		1.13 1.60	W
Electrostatic Discharge (Note 4) (Human Body Model (HBM) 100 pF/1500 Ω) Input All other			1 5	kV
Single Pulse Inductive Load Switching Energy (Note 4) ($V_{DD} = 13.5 \text{ V}$, $I = 465 \text{ mA}$, $L = 200 \text{ mH}$, $T_{J\text{Start}} = 150^\circ\text{C}$)	E_{AS}		29	mJ
Operating Junction Temperature	T_J	-40	+150	$^\circ\text{C}$
Storage Temperature	T_{storage}	-55	+150	$^\circ\text{C}$

Stresses exceeding Maximum Ratings may damage the device. Maximum Ratings are stress ratings only. Functional operation above the Recommended Operating Conditions is not implied. Extended exposure to stresses above the Recommended Operating Conditions may affect device reliability.

- Reverse Output current has to be limited by the load to stay within absolute maximum ratings and thermal performance.
- Minimum Pad.
- 1 in square pad size, FR-4, 1 oz Cu.
- Not subjected to production testing.

THERMAL RESISTANCE RATINGS

Parameter	Symbol	Max Value	Unit
Thermal Resistance (Note 5) Junction-to-Ambient (Note 2) Junction-to-Ambient (Note 3)	$R_{\theta JA}$ $R_{\theta JA}$	110 78.3	K/W

- Not subjected to production testing.

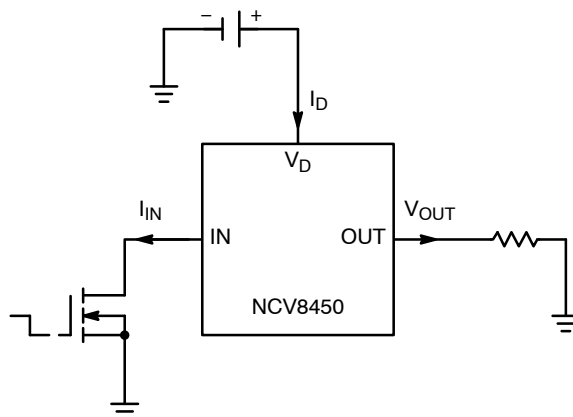

Figure 2. Applications Test Circuit

NCV8450

ELECTRICAL CHARACTERISTICS (6 ≤ V_D ≤ 45 V; -40°C < T_J < 150°C unless otherwise specified)

Rating	Symbol	Conditions	Value			Unit
			Min	Typ	Max	

OUTPUT CHARACTERISTICS

Operating Supply Voltage	V _{SUPPLY}		4.5	-	45	V
On Resistance (Pin 1 Connected to GND)	R _{ON}	T _J = 25°C, I _{OUT} = 150 mA, V _D = 7 V - 45 V T _J = 150°C, I _{OUT} = 150 mA, V _D = 7 V - 45 V (Note 6) T _J = 25°C, I _{OUT} = 150 mA, V _D = 6 V		1.0 1.4	2 3	Ω
Standby Current (Pin 1 Open)	I _D	V _D ≤ 20 V V _D > 20 V		0.6	10 100	μA

INPUT CHARACTERISTICS

Input Current – Off State	I _{IN_OFF}	V _{OUT} ≤ 0.1 V, R _L = 270 Ω, T _J = 25°C V _{OUT} ≤ 0.1V, R _L = 270 Ω, T _J = 150°C (Note 6)	-50 -40			μA
Input Current – On State (Pin 1 Grounded)	I _{IN_ON}			1.5	3	mA
Input Resistance (Note 6)	R _{IN}			1		kΩ

SWITCHING CHARACTERISTICS

Turn-On Time (Note 7) (V _{IN} = V _D to 0 V) to 90% V _{OUT}	t _{ON}	R _L = 270 Ω (Note 6) V _D = 13.5 V, R _L = 270 Ω, T _J = 25°C		30	125 100	μs
Turn-Off Time (Note 7) (V _{IN} = 0 V to V _D) to 10% V _{OUT}	t _{OFF}	R _L = 270 Ω (Note 6) V _D = 13.5 V, R _L = 270 Ω, T _J = 25°C		60	175 150	μs
Slew Rate On (Note 7) (V _{IN} = V _D to 0V) 10% to 30% V _{OUT}	dV/dt _{ON}	R _L = 270 Ω (Note 6) V _D = 13.5 V, R _L = 270 Ω, T _J = 25°C		0.7	4 4	V/μs
Slew Rate Off (Note 7) (V _{IN} = 0 V to V _D) 70% to 40% V _{OUT}	dV/dt _{OFF}	R _L = 270 Ω (Note 6) V _D = 13.5 V, R _L = 270 Ω, T _J = 25°C		0.9	4 4	V/μs

OUTPUT DIODE CHARACTERISTICS (Note 6)

Drain-Source Diode Voltage	V _F	I _{OUT} = -0.2 A		0.6		V
Continuous Reverse Drain Current	I _S	T _J = 25°C			0.2	A

PROTECTION FUNCTIONS (Note 8)

Temperature Shutdown (Note 6)	T _{SD}		150	175	-	°C
Temperature Shutdown Hysteresis (Note 6)	T _{SD_HYST}			5		°C
Output Current Limit	I _{LIM}	T _J = -40°C, V _D = 13.5 V, t _m = 100 μs (Note 6) T _J = 25 °C, V _D = 13.5 V, t _m = 100 μs T _J = 150 °C, V _D = 13.5 V, t _m = 100 μs (Note 6)	0.5	0.8	1.5	A
Output Clamp Voltage (Inductive Load Switch Off) At V _{OUT} = V _D - V _{CLAMP}	V _{CLAMP}	I _{OUT} = 4 mA	45	52		V
Overvoltage Protection	V _{IN_CL}	I _{CLAMP} = 4 mA	50	54		V

6. Not subjected to production testing

7. Only valid with high input slew rates

8. Protection functions are not designed for continuous repetitive operation and are considered outside normal operating range

TYPICAL CHARACTERISTIC CURVES

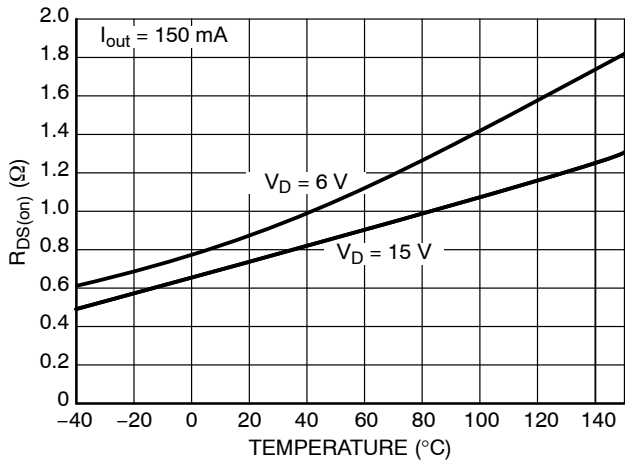

Figure 3. $R_{DS(on)}$ vs. Temperature

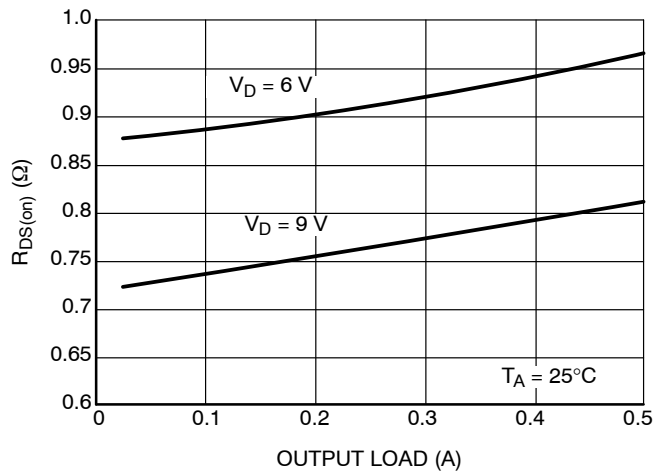

Figure 4. $R_{DS(on)}$ vs. Output Load

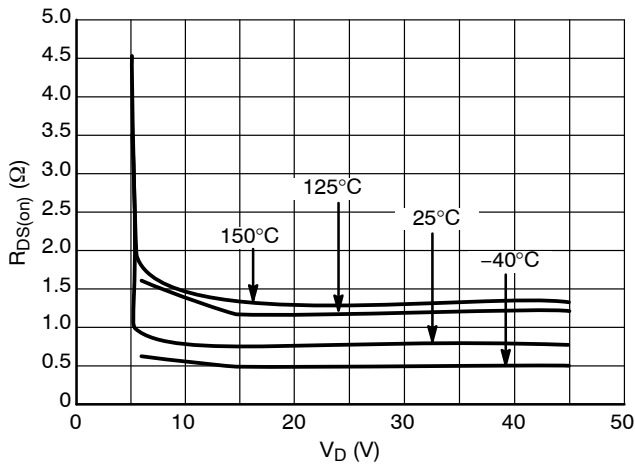

Figure 5. $R_{DS(on)}$ vs. V_D

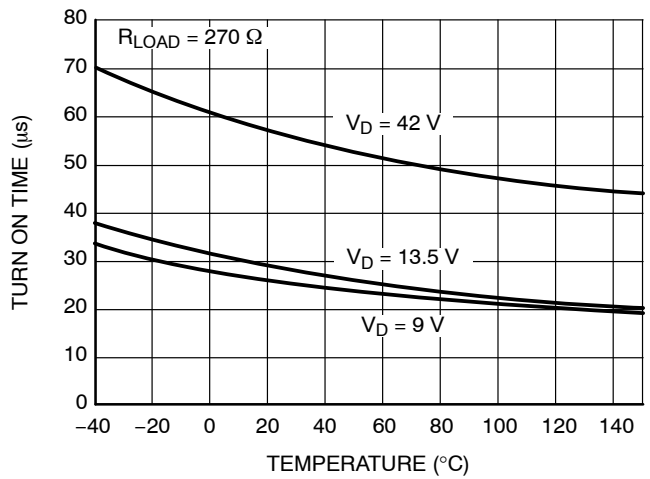

Figure 6. Turn On Time vs. Temperature

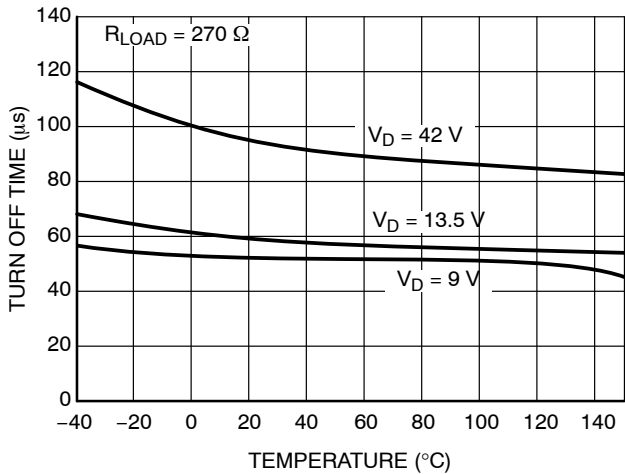

Figure 7. Turn Off Time vs. Temperature

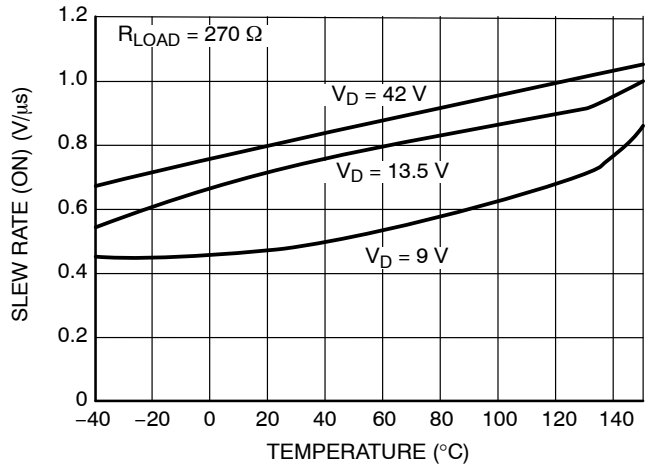

Figure 8. Slew Rate (ON) vs. Temperature

TYPICAL CHARACTERISTIC CURVES

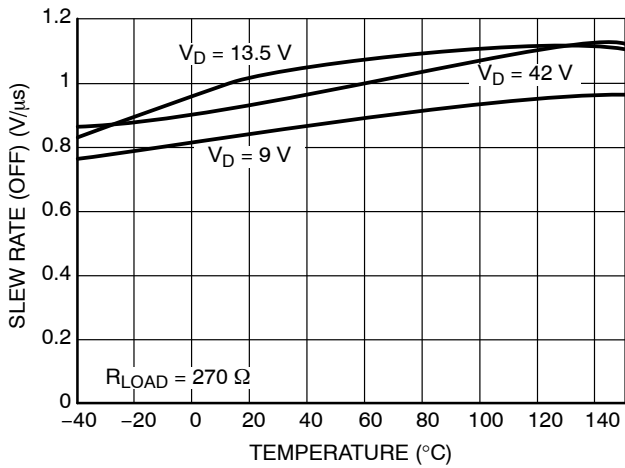

Figure 9. Slew Rate (OFF) vs. Temperature

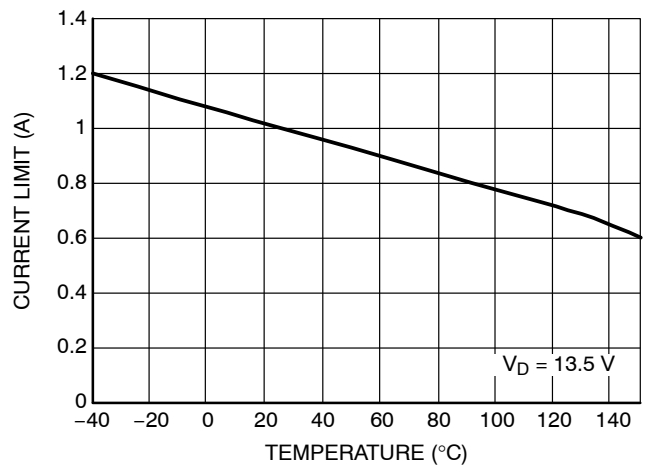

Figure 10. Current Limit vs. Temperature

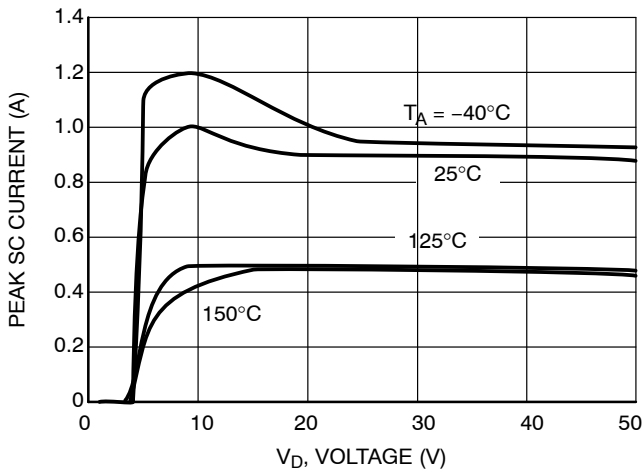

Figure 11. Peak Short Circuit Current vs. V_D Voltage

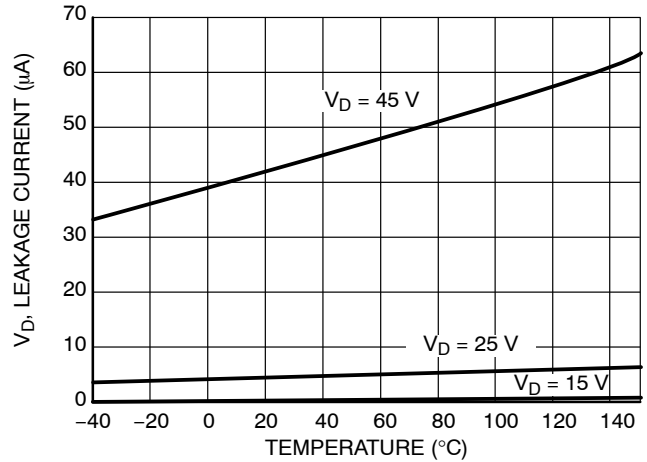

Figure 12. V_D Leakage Current vs. Temperature Off-State

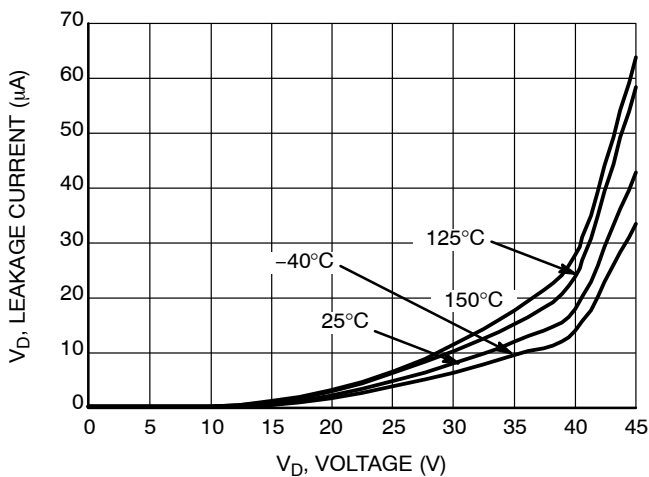

Figure 13. V_D Leakage Current vs. V_D Voltage Off-State

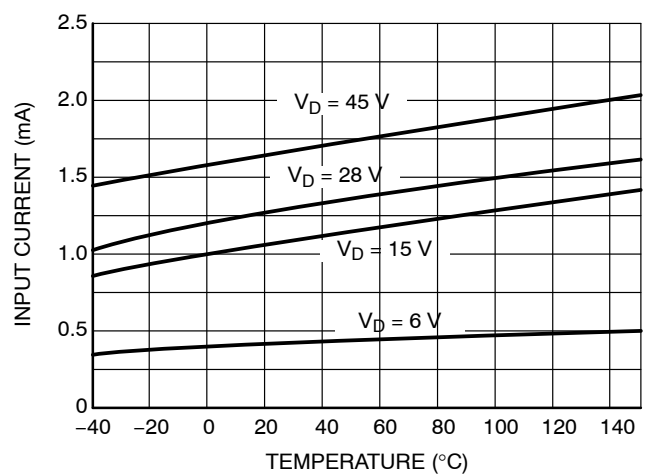

Figure 14. On-State Input Current vs. Temperature

TYPICAL CHARACTERISTIC CURVES

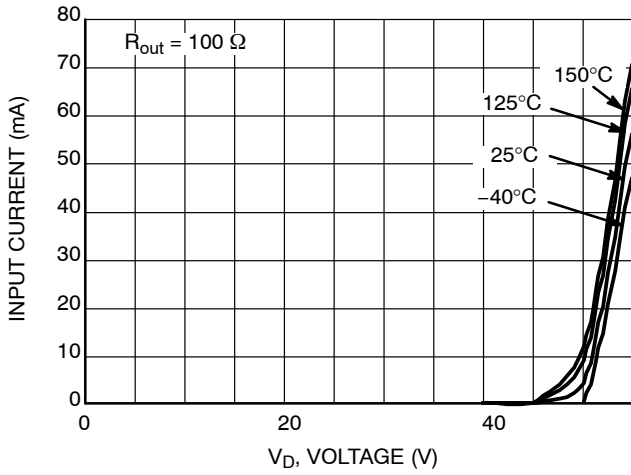

Figure 18. Input Current vs. V_D Voltage Off-State

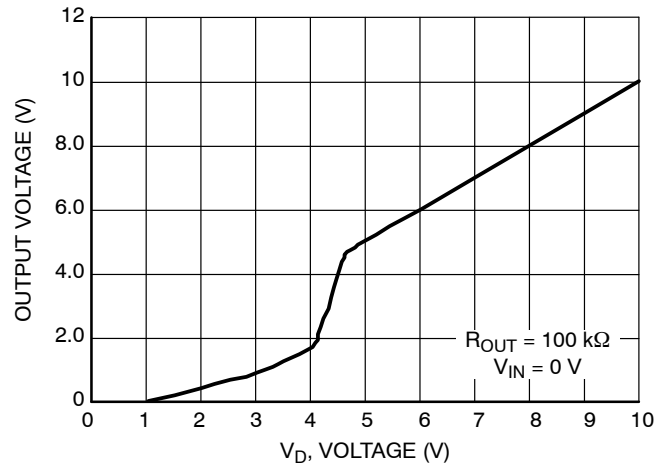

Figure 15. Output Voltage vs. V_D Voltage

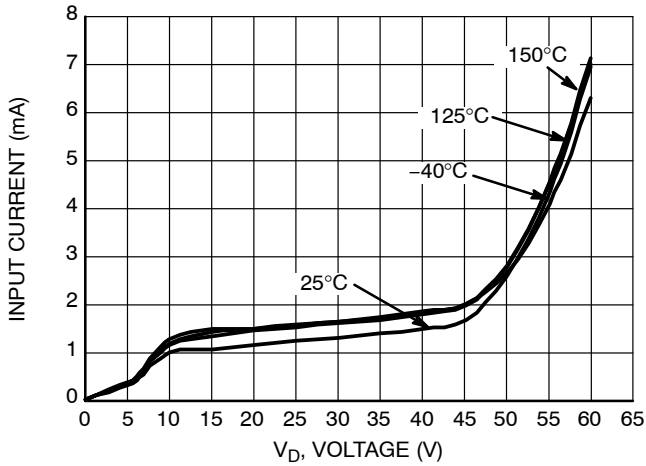

Figure 16. Input Current vs. V_D Voltage On-State

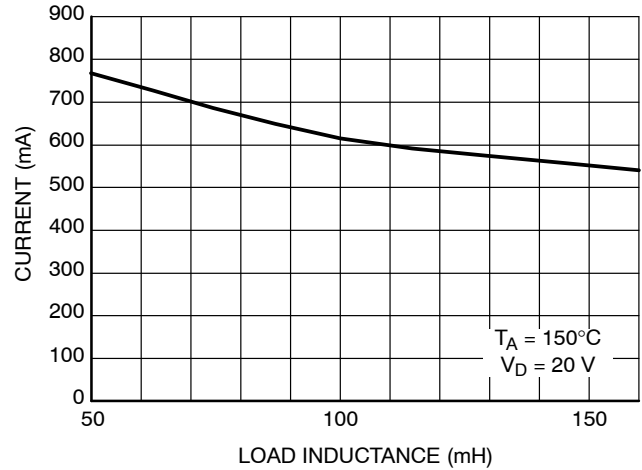

Figure 17. Single Pulse Maximum Switch-off Current vs. Load Inductance

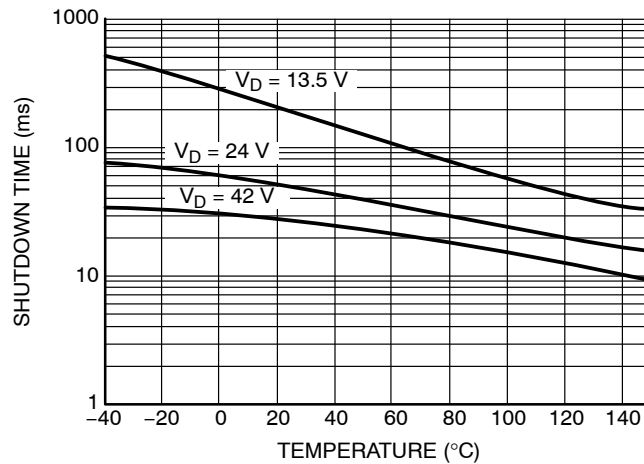

Figure 19. Initial Short-Circuit Shutdown Time vs. Temperature

NCV8450

TYPICAL CHARACTERISTIC CURVES

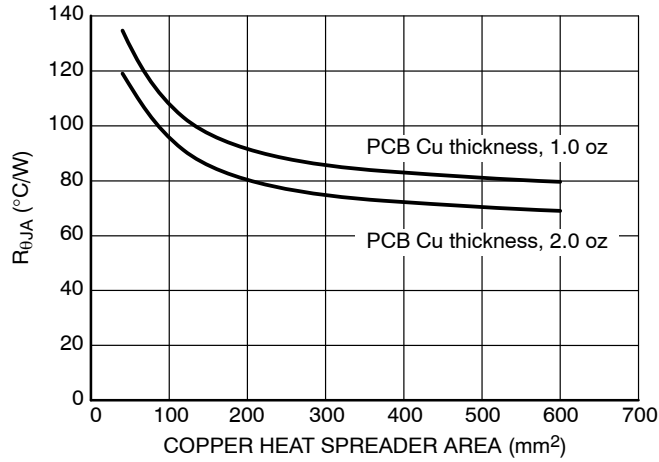

Figure 20. $R_{\theta JA}$ vs. Copper Area

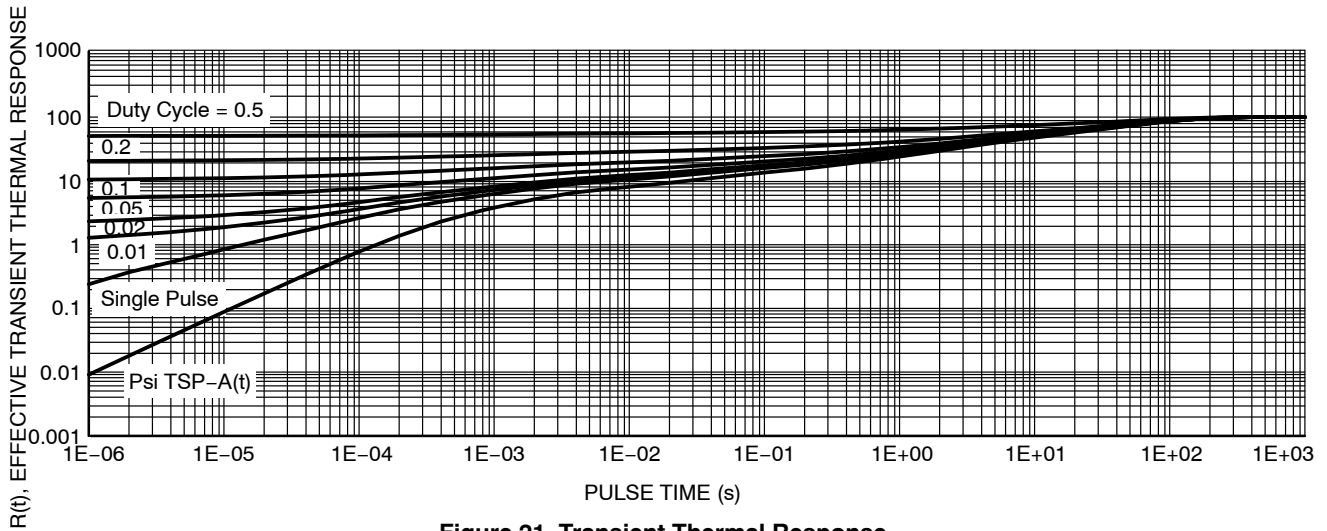

Figure 21. Transient Thermal Response

ISO PULSE TEST RESULTS

Test Pulse	Test Level	Test Results	Pulse Cycle Time and Generator Impedance
1	200 V	C	500 ms, 10 Ω
2	150 V	C	500 ms, 10 Ω
3a	200 V	C	100 ms, 50 Ω
3b	200 V	C	100 ms, 50 Ω
5	175 V	E(100 V)	400 ms, 2 Ω

ORDERING INFORMATION

Device	Package	Shipping [†]
NCV8450STT3G	SOT-223 (Pb-Free)	4000 / Tape & Reel

[†]For information on tape and reel specifications, including part orientation and tape sizes, please refer to our Tape and Reel Packaging Specifications Brochure, BRD8011/D.

NCV8450

PACKAGE DIMENSIONS

SOT-223 (TO-261)
CASE 318E-04
ISSUE M

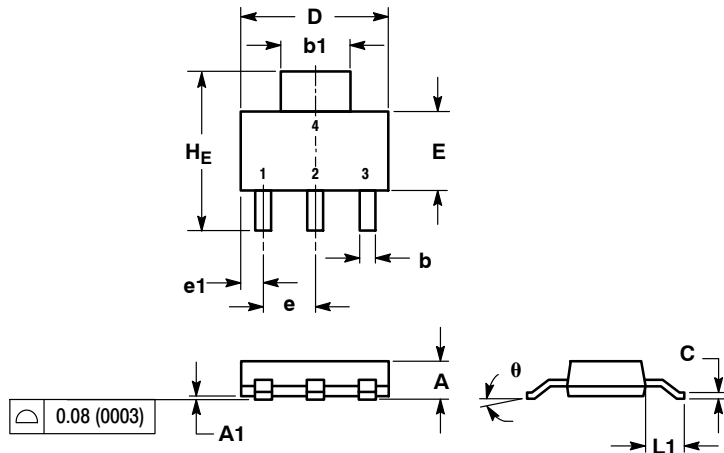

- NOTES:
1. DIMENSIONING AND TOLERANCING PER ANSI Y14.5M, 1982.
2. CONTROLLING DIMENSION: INCH.

DIM	MILLIMETERS			INCHES		
	MIN	NOM	MAX	MIN	NOM	MAX
A	1.50	1.63	1.75	0.060	0.064	0.068
A1	0.02	0.06	0.10	0.001	0.002	0.004
b	0.60	0.75	0.89	0.024	0.030	0.035
b1	2.90	3.06	3.20	0.115	0.121	0.126
c	0.24	0.29	0.35	0.009	0.012	0.014
D	6.30	6.50	6.70	0.249	0.256	0.263
E	3.30	3.50	3.70	0.130	0.138	0.145
e	2.20	2.30	2.40	0.087	0.091	0.094
e1	0.85	0.94	1.05	0.033	0.037	0.041
H	1.50	1.75	2.00	0.060	0.069	0.078
L1	6.70	7.00	7.30	0.264	0.276	0.287
θ	0°	-	10°	0°	-	10°

SOLDERING FOOTPRINT*

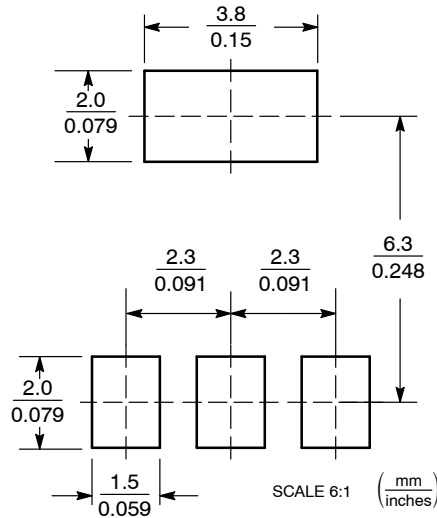

*For additional information on our Pb-Free strategy and soldering details, please download the ON Semiconductor Soldering and Mounting Techniques Reference Manual, SOLDERRM/D.

ON Semiconductor and are registered trademarks of Semiconductor Components Industries, LLC (SCILLC). SCILLC reserves the right to make changes without further notice to any products herein. SCILLC makes no warranty, representation or guarantee regarding the suitability of its products for any particular purpose, nor does SCILLC assume any liability arising out of the application or use of any product or circuit, and specifically disclaims any and all liability, including without limitation special, consequential or incidental damages. "Typical" parameters which may be provided in SCILLC data sheets and/or specifications can and do vary in different applications and actual performance may vary over time. All operating parameters, including "Typicals" must be validated for each customer application by customer's technical experts. SCILLC does not convey any license under its patent rights nor the rights of others. SCILLC products are not designed, intended, or authorized for use as components in systems intended for surgical implant into the body, or other applications intended to support or sustain life, or for any other application in which the failure of the SCILLC product could create a situation where personal injury or death may occur. Should Buyer purchase or use SCILLC products for any such unintended or unauthorized application, Buyer shall indemnify and hold SCILLC and its officers, employees, subsidiaries, affiliates, and distributors harmless against all claims, costs, damages, and expenses, and reasonable attorney fees arising out of, directly or indirectly, any claim of personal injury or death associated with such unintended or unauthorized use, even if such claim alleges that SCILLC was negligent regarding the design or manufacture of the part. SCILLC is an Equal Opportunity/Affirmative Action Employer. This literature is subject to all applicable copyright laws and is not for resale in any manner.

PUBLICATION ORDERING INFORMATION

LITERATURE FULFILLMENT:
Literature Distribution Center for ON Semiconductor
P.O. Box 5163, Denver, Colorado 80217 USA
Phone: 303-675-2175 or 800-344-3860 Toll Free USA/Canada
Fax: 303-675-2176 or 800-344-3867 Toll Free USA/Canada
Email: orderlit@onsemi.com

N. American Technical Support: 800-282-9855 Toll Free
USA/Canada
Europe, Middle East and Africa Technical Support:
Phone: 421 33 790 2910
Japan Customer Focus Center
Phone: 81-3-5773-3850

ON Semiconductor Website: www.onsemi.com
Order Literature: <http://www.onsemi.com/orderlit>
For additional information, please contact your local Sales Representative