

Common Mode Filters

For automobile signal line

ACT series

Type:	ACT45B	[1812 inch]* (CAN-BUS)
	ACT45R	[1812 inch] (FlexRay)

* Dimensions Code [EIA]

Issue date: July 2012

- All specifications are subject to change without notice.
- Conformity to RoHS Directive: This means that, in conformity with EU Directive 2002/95/EC, lead, cadmium, mercury, hexavalent chromium, and specific bromine-based flame retardants, PBB and PBDE, have not been used, except for exempted applications.

Common Mode Filters For Automobile Signal Line

Conformity to RoHS Directive

ACT Series ACT45B

FEATURES

- Operating temperature range covers from -40 to $+150^{\circ}\text{C}$.
- Non-dissolution of the abutment amounts in circuit board mounting.
- The products contain no lead and also support lead-free soldering.
- This product conforms to the standards that are slated to be introduced under the RoHS Directive.

APPLICATIONS

CAN-BUS, facsimiles, modems, ISDN

TEMPERATURE RANGES

Operating	-40 to $+150^{\circ}\text{C}$
Storage(After mount)	-40 to $+150^{\circ}\text{C}$

PACKAGING STYLE AND QUANTITIES

Packaging style	Quantity
Taping	2500 pieces/reel

SHAPES AND DIMENSIONS/CIRCUIT DIAGRAM

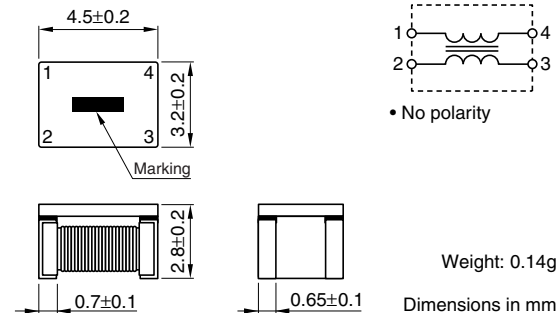

RECOMMENDED PC BOARD PATTERN

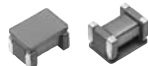
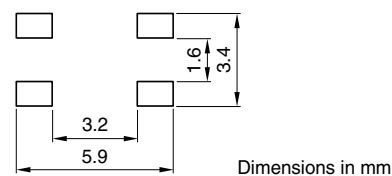

PRODUCT IDENTIFICATION

ACT45B - 510 - 2P - TL
 (1) (2) (3) (4) (5)

- (1) Series name
- (2) Inductance value (typ.)
510: 51 μH
- (3) Number of line
2P: 2-line
- (4) Packaging style
TL: ϕ 330mm reel taping
- (5) TDK internal code

RECOMMENDED SOLDERING CONDITIONS RECOMMENDED TEMPERATURE PROFILE FOR LEAD-FREE SOLDER

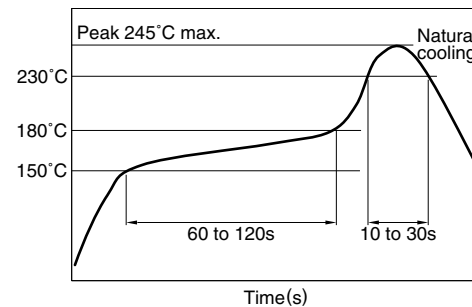

REFLOW PROFILE FOR SOLDER HEAT RESISTANCE

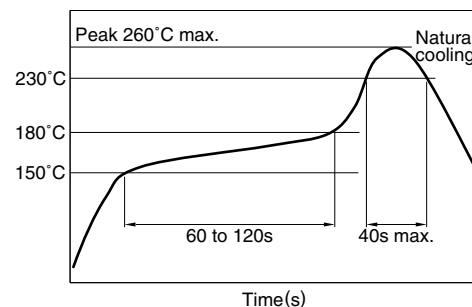

• Conformity to RoHS Directive: This means that, in conformity with EU Directive 2002/95/EC, lead, cadmium, mercury, hexavalent chromium, and specific bromine-based flame retardants, PBB and PBDE, have not been used, except for exempted applications.

• All specifications are subject to change without notice.

ELECTRICAL CHARACTERISTICS

Part No.	Common mode impedance (Ω)[10MHz]		Common mode inductance (μH)+50/-30% [100kHz]	Stray inductance (μH)typ. [100kHz]	DC resistance (Ω)max.	Rated current (A)max.	Insulation resistance ($\text{M}\Omega$)min.	Rated voltage (V)max.
	min.	typ.						
ACT45B-110-2P	300	600	11	0.05	0.6	0.25	10	50
ACT45B-220-2P	500	1200	22	0.08	1.0	0.2	10	50
ACT45B-510-2P	1000	2800	51	0.15	1.0	0.2	10	50
ACT45B-101-2P	2000	5800	100	0.20	2.0	0.15	10	50

TYPICAL ELECTRICAL CHARACTERISTICS

IMPEDANCE vs. FREQUENCY CHARACTERISTICS

ACT45B-110-2P

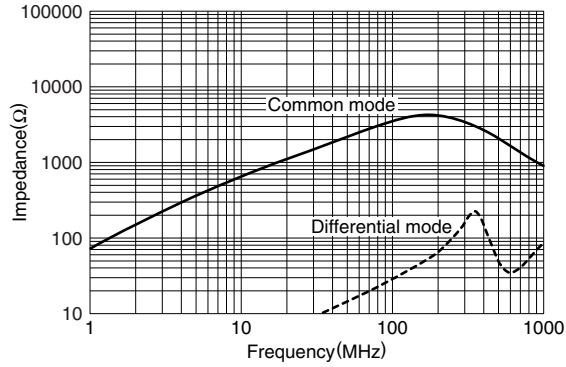

ACT45B-220-2P

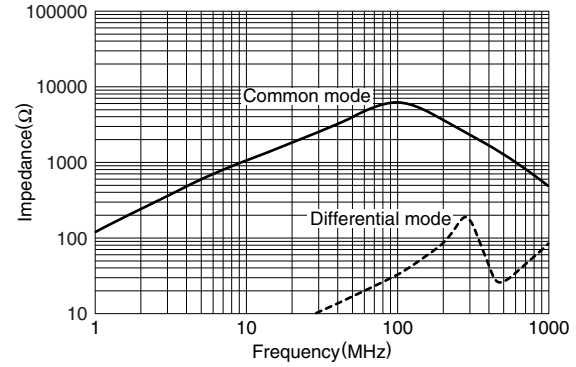

ACT45B-510-2P

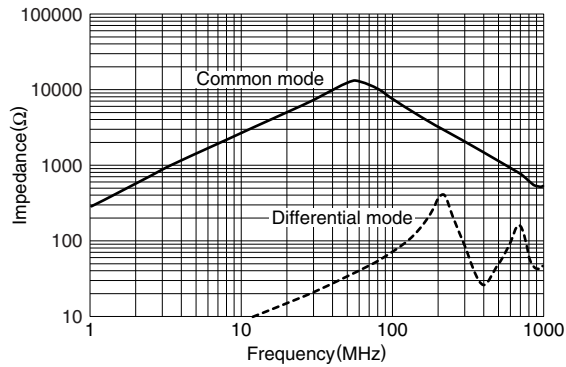

ACT45B-101-2P

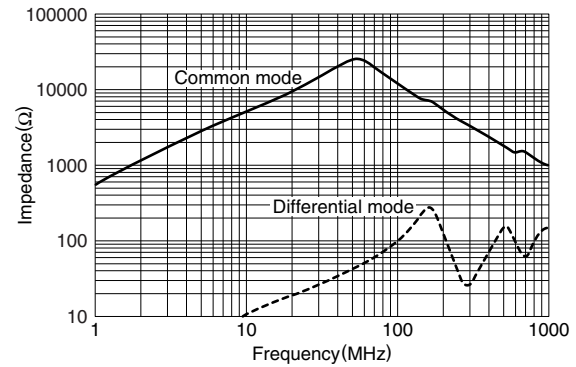

Common Mode Filters For Automobile Signal Line

Conformity to RoHS Directive

ACT Series ACT45R

FEATURES

- Operating temperature range covers from -40 to $+150^{\circ}\text{C}$.
- Non-dissolution of the abutment amounts in circuit board mounting.
- The products contain no lead and also support lead-free soldering.
- This product conforms to the standards that are slated to be introduced under the RoHS Directive.

APPLICATIONS

FlexRay system

TEMPERATURE RANGES

Operating	-40 to $+150^{\circ}\text{C}$
Storage(After mount)	-40 to $+150^{\circ}\text{C}$

PACKAGING STYLE AND QUANTITIES

Packaging style	Quantity
Taping	2500 pieces/reel

SHAPES AND DIMENSIONS/CIRCUIT DIAGRAM

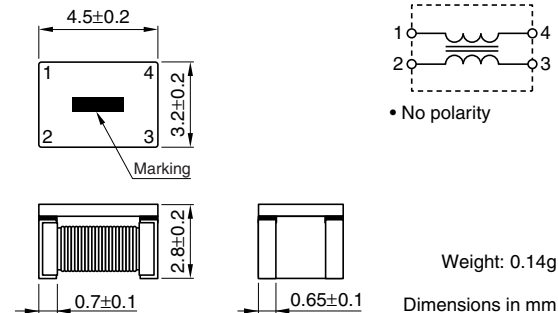

RECOMMENDED PC BOARD PATTERN

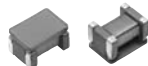
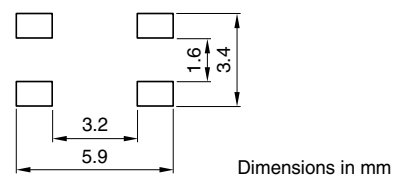

PRODUCT IDENTIFICATION

ACT45R - 101 - 2P - TL
 (1) (2) (3) (4) (5)

- (1) Series name
 (2) Inductance value (typ.)
 101: $100\mu\text{H}$
 (3) Number of line
 2P: 2-line
 (4) Packaging style
 TL: $\phi 330\text{mm}$ reel taping
 (5) TDK internal code

RECOMMENDED SOLDERING CONDITIONS RECOMMENDED TEMPERATURE PROFILE FOR LEAD-FREE SOLDER

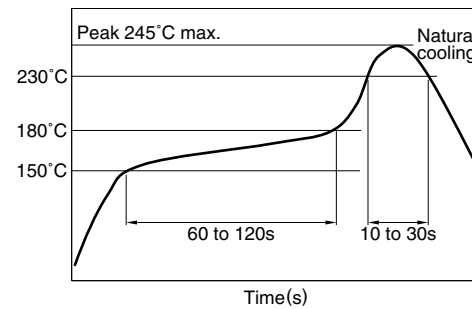

REFLOW PROFILE FOR SOLDER HEAT RESISTANCE

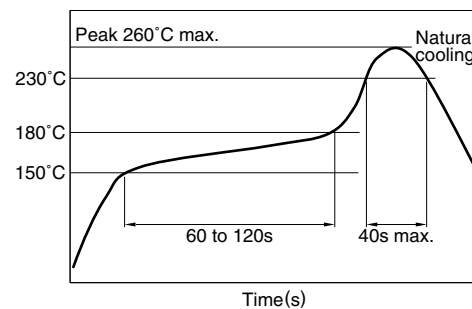

• Conformity to RoHS Directive: This means that, in conformity with EU Directive 2002/95/EC, lead, cadmium, mercury, hexavalent chromium, and specific bromine-based flame retardants, PBB and PBDE, have not been used, except for exempted applications.

• All specifications are subject to change without notice.

ELECTRICAL CHARACTERISTICS

Part No.	Common mode impedance (Ω) [10MHz]		Common mode inductance (μ H)+50/-30% [100kHz]	Stray inductance (μ H)typ. [100kHz]	DC resistance (Ω)max.	Rated current (A)max.	Insulation resistance (M Ω)min.	Rated voltage (V)max.
	min.	typ.						
ACT45R-101-2P-TL001	2200	5500	100	0.2	1.5	0.2	10	50

TYPICAL ELECTRICAL CHARACTERISTICS IMPEDANCE vs. FREQUENCY CHARACTERISTICS

