

FDD8424H

Dual N & P-Channel PowerTrench® MOSFET N-Channel: 40V, 20A, 24mΩ P-Channel: -40V, -20A, 54mΩ

Features

Q1: N-Channel

- Max $r_{DS(on)}$ = 24mΩ at $V_{GS} = 10V$, $I_D = 9.0A$
- Max $r_{DS(on)}$ = 30mΩ at $V_{GS} = 4.5V$, $I_D = 7.0A$

Q2: P-Channel

- Max $r_{DS(on)}$ = 54mΩ at $V_{GS} = -10V$, $I_D = -6.5A$
- Max $r_{DS(on)}$ = 70mΩ at $V_{GS} = -4.5V$, $I_D = -5.6A$
- Fast switching speed
- RoHS Compliant



General Description

These dual N and P-Channel enhancement mode Power MOSFETs are produced using Fairchild Semiconductor's advanced PowerTrench- process that has been especially tailored to minimize on-state resistance and yet maintain superior switching performance.

Application

- Inverter
- H-Bridge

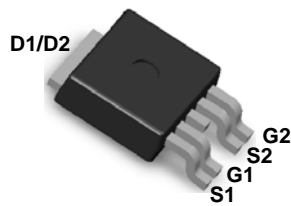

Dual DPAK 4L

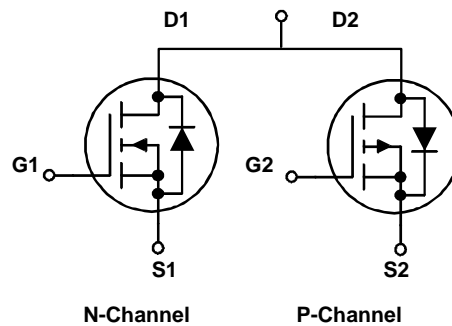

MOSFET Maximum Ratings $T_C = 25^\circ\text{C}$ unless otherwise noted

Symbol	Parameter	Q1	Q2	Units
V_{DS}	Drain to Source Voltage	40	-40	V
V_{GS}	Gate to Source Voltage	± 20	± 20	V
I_D	Drain Current - Continuous (Package Limited)	20	-20	A
	- Continuous (Silicon Limited) $T_C = 25^\circ\text{C}$	26	-20	
	- Continuous $T_A = 25^\circ\text{C}$	9.0	-6.5	
	- Pulsed	55	-40	
P_D	Power Dissipation for Single Operation $T_C = 25^\circ\text{C}$ (Note 1)	30	35	W
	$T_A = 25^\circ\text{C}$ (Note 1a)	3.1		
	$T_A = 25^\circ\text{C}$ (Note 1b)	1.3		
E_{AS}	Single Pulse Avalanche Energy (Note 3)	29	33	mJ
T_J, T_{STG}	Operating and Storage Junction Temperature Range	-55 to +150		$^\circ\text{C}$

Thermal Characteristics

$R_{\theta JC}$	Thermal Resistance, Junction to Case, Single Operation for Q1 (Note 1)	4.1	$^\circ\text{C/W}$
$R_{\theta JC}$	Thermal Resistance, Junction to Case, Single Operation for Q2 (Note 1)	3.5	

Package Marking and Ordering Information

Device Marking	Device	Package	Reel Size	Tape Width	Quantity
FDD8424H	FDD8424H	TO-252-4L	13"	12mm	2500 units

Electrical Characteristics $T_J = 25^\circ\text{C}$ unless otherwise noted

Symbol	Parameter	Test Conditions	Type	Min	Typ	Max	Units
--------	-----------	-----------------	------	-----	-----	-----	-------

Off Characteristics

BV_{DSS}	Drain to Source Breakdown Voltage	$I_D = 250\mu\text{A}, V_{GS} = 0\text{V}$ $I_D = -250\mu\text{A}, V_{GS} = 0\text{V}$	Q1 Q2	40 -40			V
$\frac{\Delta BV_{DSS}}{\Delta T_J}$	Breakdown Voltage Temperature Coefficient	$I_D = 250\mu\text{A}$, referenced to 25°C $I_D = -250\mu\text{A}$, referenced to 25°C	Q1 Q2		34 -32		mV/ $^\circ\text{C}$
I_{DSS}	Zero Gate Voltage Drain Current	$V_{DS} = 32\text{V}, V_{GS} = 0\text{V}$ $V_{DS} = -32\text{V}, V_{GS} = 0\text{V}$	Q1 Q2			1 -1	μA
I_{GSS}	Gate to Source Leakage Current	$V_{GS} = \pm 20\text{V}, V_{DS} = 0\text{V}$	Q1 Q2			± 100 ± 100	nA nA

On Characteristics

$V_{GS(th)}$	Gate to Source Threshold Voltage	$V_{GS} = V_{DS}, I_D = 250\mu\text{A}$ $V_{GS} = V_{DS}, I_D = -250\mu\text{A}$	Q1 Q2	1 -1	1.7 -1.6	3 -3	V
$\frac{\Delta V_{GS(th)}}{\Delta T_J}$	Gate to Source Threshold Voltage Temperature Coefficient	$I_D = 250\mu\text{A}$, referenced to 25°C $I_D = -250\mu\text{A}$, referenced to 25°C	Q1 Q2		-5.3 4.8		mV/ $^\circ\text{C}$
$r_{DS(on)}$	Static Drain to Source On Resistance	$V_{GS} = 10\text{V}, I_D = 9.0\text{A}$ $V_{GS} = 4.5\text{V}, I_D = 7.0\text{A}$ $V_{GS} = 10\text{V}, I_D = 9.0\text{A}, T_J = 125^\circ\text{C}$ $V_{GS} = -10\text{V}, I_D = -6.5\text{A}$ $V_{GS} = -4.5\text{V}, I_D = -5.6\text{A}$ $V_{GS} = -10\text{V}, I_D = -6.5\text{A}, T_J = 125^\circ\text{C}$	Q1 Q2		19 23 29 42 58 62	24 30 37 54 70 80	m Ω
g_{FS}	Forward Transconductance	$V_{DS} = 5\text{V}, I_D = 9.0\text{A}$ $V_{DS} = -5\text{V}, I_D = -6.5\text{A}$	Q1 Q2		29 13		S

Dynamic Characteristics

C_{iss}	Input Capacitance	Q1 $V_{DS} = 20\text{V}, V_{GS} = 0\text{V}, f = 1\text{MHz}$	Q1 Q2		750 1000	1000 1330	pF
C_{oss}	Output Capacitance	Q2	Q1 Q2		115 140	155 185	pF
C_{riss}	Reverse Transfer Capacitance	$V_{DS} = -20\text{V}, V_{GS} = 0\text{V}, f = 1\text{MHz}$	Q1 Q2		75 75	115 115	pF
R_g	Gate Resistance	$f = 1\text{MHz}$	Q1 Q2		1.1 3.3		Ω

Switching Characteristics

$t_{d(on)}$	Turn-On Delay Time	Q1 $V_{DD} = 20\text{V}, I_D = 9.0\text{A},$ $V_{GS} = 10\text{V}, R_{GEN} = 6\Omega$	Q1 Q2		7 7	14 14	ns
t_r	Rise Time	$V_{GS} = 10\text{V}, R_{GEN} = 6\Omega$	Q1 Q2		13 3	24 10	ns
$t_{d(off)}$	Turn-Off Delay Time	Q2 $V_{DD} = -20\text{V}, I_D = -6.5\text{A},$ $V_{GS} = -10\text{V}, R_{GEN} = 6\Omega$	Q1 Q2		17 20	31 36	ns
t_f	Fall Time	$V_{GS} = -10\text{V}, R_{GEN} = 6\Omega$	Q1 Q2		6 3	12 10	ns
$Q_{g(TOT)}$	Total Gate Charge	Q1 $V_{GS} = 10\text{V}, V_{DD} = 20\text{V}, I_D = 9.0\text{A}$	Q1 Q2		14 17	20 24	nC
Q_{gs}	Gate to Source Charge	Q2	Q1 Q2		2.3 3.0		nC
Q_{gd}	Gate to Drain "Miller" Charge	$V_{GS} = -10\text{V}, V_{DD} = -20\text{V}, I_D = -6.5\text{A}$	Q1 Q2		3.2 3.6		nC

Electrical Characteristics $T_J = 25^\circ\text{C}$ unless otherwise noted

Symbol	Parameter	Test Conditions	Type	Min	Typ	Max	Units
--------	-----------	-----------------	------	-----	-----	-----	-------

Drain-Source Diode Characteristics

V_{SD}	Source to Drain Diode Forward Voltage	$V_{GS} = 0V, I_S = 9.0A$ (Note 2)	Q1		0.87	1.2	V
		$V_{GS} = 0V, I_S = -6.5A$ (Note 2)	Q2		0.88	-1.2	
t_{rr}	Reverse Recovery Time	Q1 $I_F = 9.0A, di/dt = 100A/s$	Q1		25	38	ns
			Q2		29	44	
Q_{rr}	Reverse Recovery Charge	Q2 $I_F = -6.5A, di/dt = 100A/s$	Q1		19	29	nC
			Q2		29	44	

Notes:

- $R_{\theta JA}$ is determined with the device mounted on a 1 in² pad 2 oz copper pad on a 1.5 x 1.5 in. board of FR-4 material. $R_{\theta JC}$ is guaranteed by design while $R_{\theta CA}$ is determined by the user's board design.

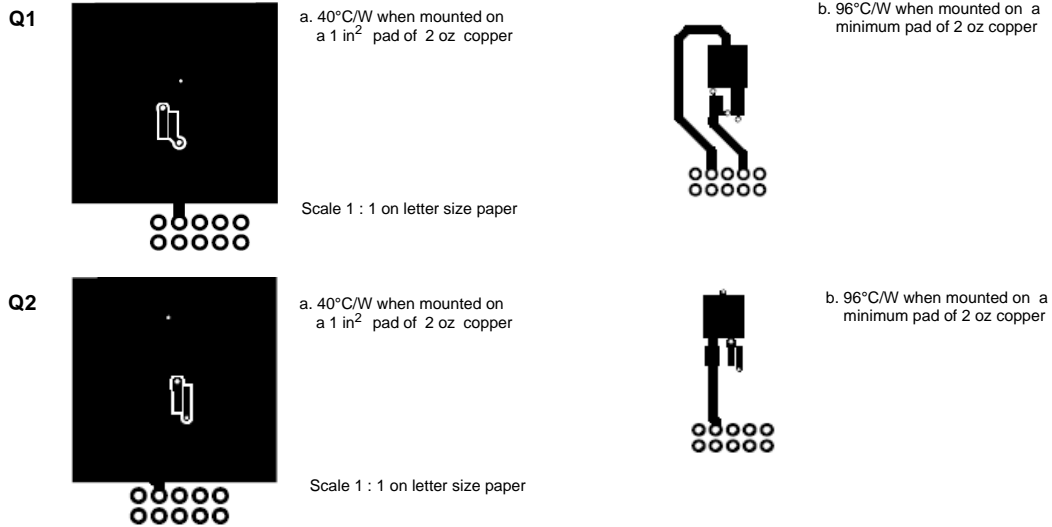

- Pulse Test: Pulse Width < 300μs, Duty cycle < 2.0%.

- Starting $T_J = 25^\circ\text{C}$, N-ch: $L = 0.3mH, I_{AS} = 14A, V_{DD} = 40V, V_{GS} = 10V$; P-ch: $L = 0.3mH, I_{AS} = -15A, V_{DD} = -40V, V_{GS} = -10V$.

Typical Characteristics (Q1 N-Channel) $T_J = 25^\circ\text{C}$ unless otherwise noted

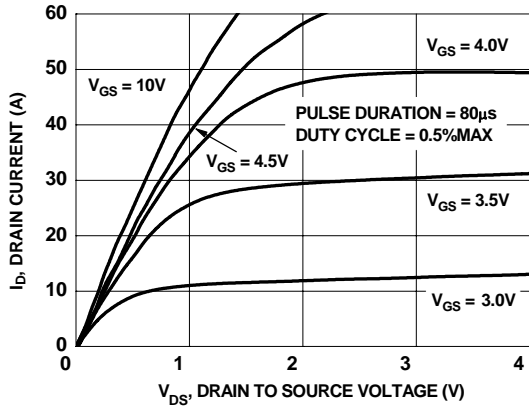

Figure 1. On-Region Characteristics

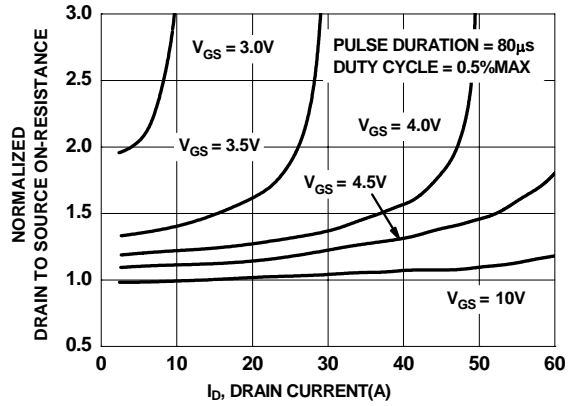

Figure 2. Normalized On-Resistance vs Drain Current and Gate Voltage

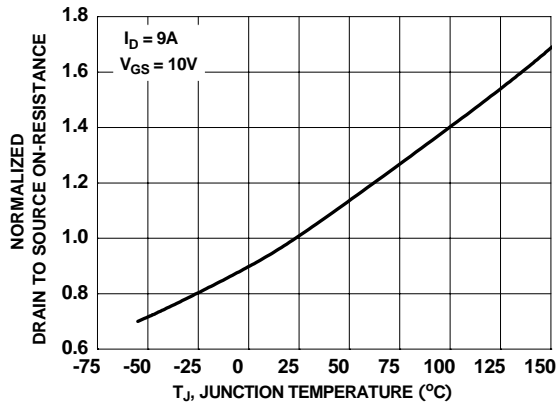

Figure 3. Normalized On-Resistance vs Junction Temperature

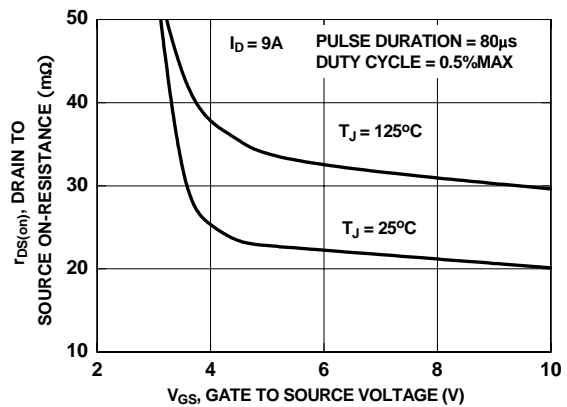

Figure 4. On-Resistance vs Gate to Source Voltage

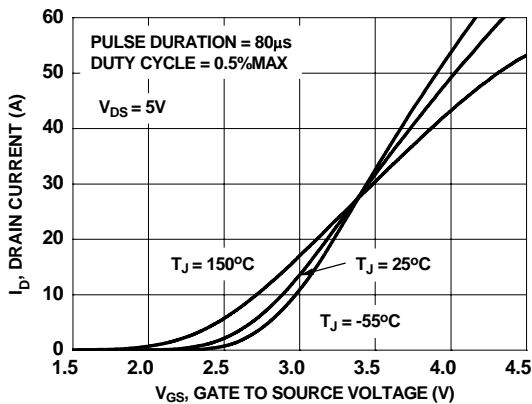

Figure 5. Transfer Characteristics

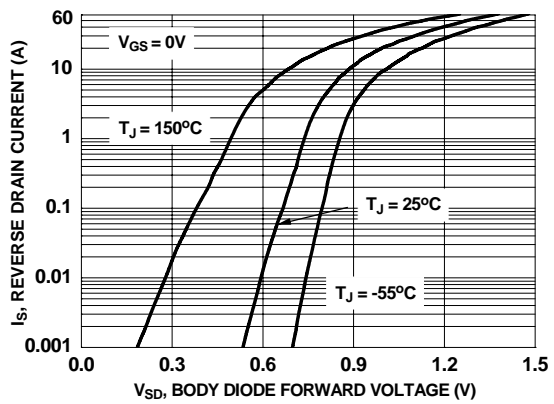

Figure 6. Source to Drain Diode Forward Voltage vs Source Current

Typical Characteristics (Q1 N-Channel) $T_J = 25^\circ\text{C}$ unless otherwise noted

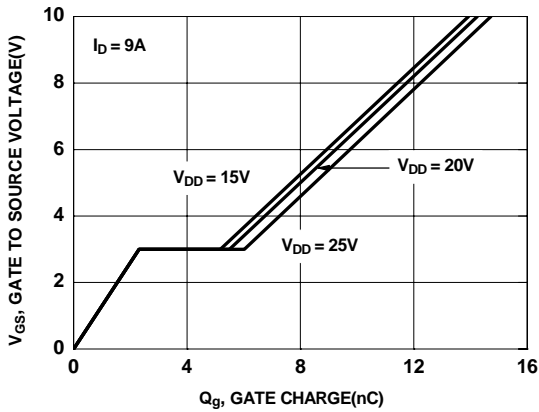

Figure 7. Gate Charge Characteristics

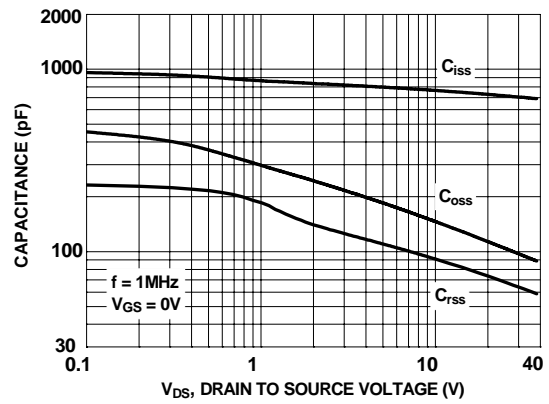

Figure 8. Capacitance vs Drain to Source Voltage

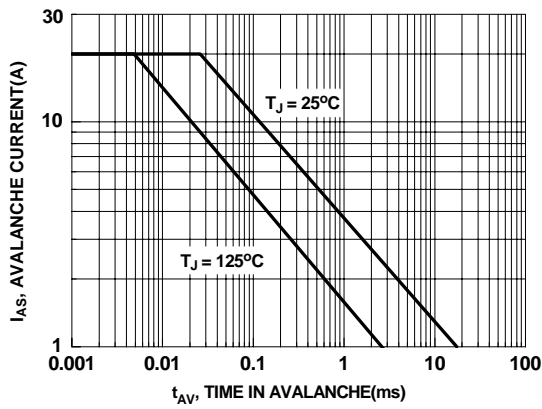

Figure 9. Unclamped Inductive Switching Capability

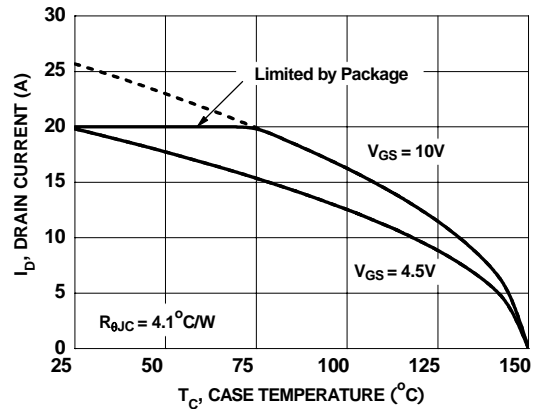

Figure 10. Maximum Continuous Drain Current vs Case Temperature

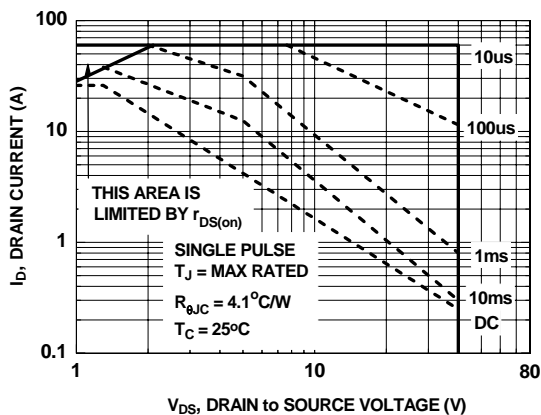

Figure 11. Forward Bias Safe Operating Area

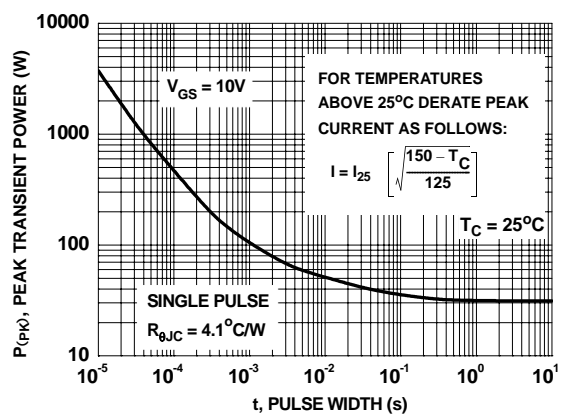

Figure 12. Single Pulse Maximum Power Dissipation

Typical Characteristics (Q1 N-Channel) $T_J = 25^\circ\text{C}$ unless otherwise noted

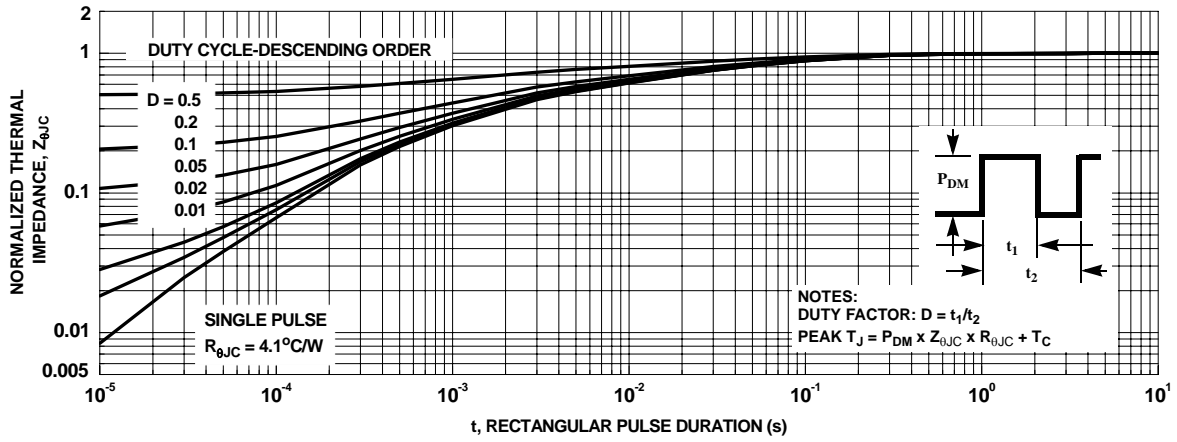

Figure 13. Transient Thermal Response Curve

Typical Characteristics (Q2 P-Channel) $T_J = 25^\circ\text{C}$ unless otherwise noted

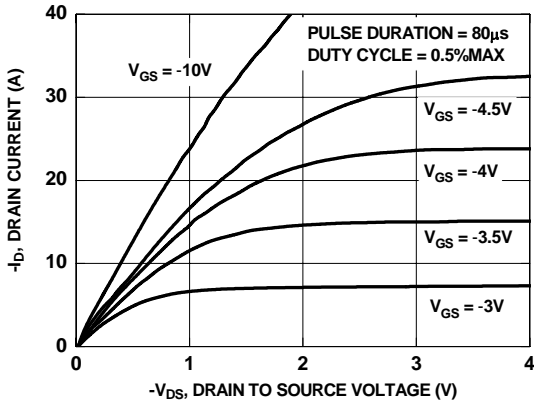

Figure 14. On-Region Characteristics

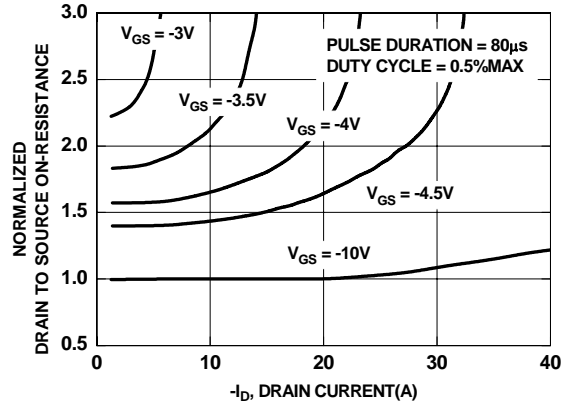

Figure 15. Normalized on-Resistance vs Drain Current and Gate Voltage

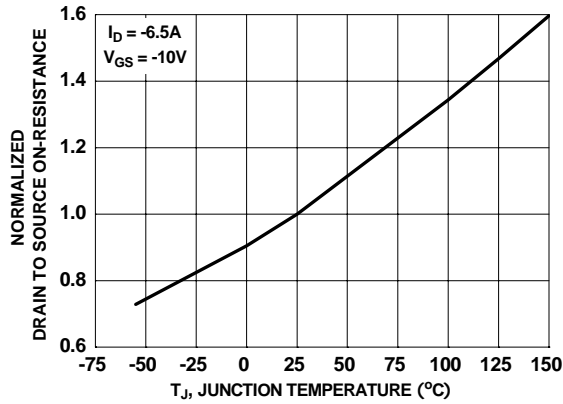

Figure 16. Normalized On-Resistance vs Junction Temperature

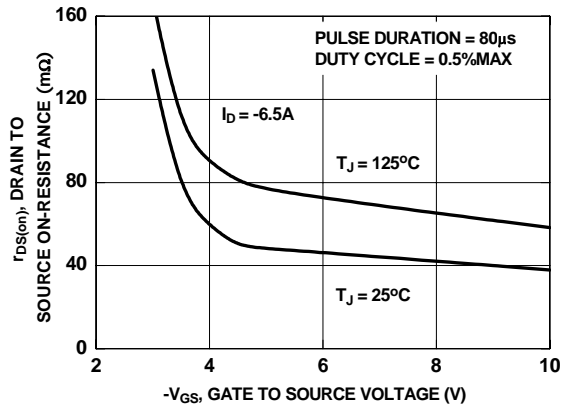

Figure 17. On-Resistance vs Gate to Source Voltage

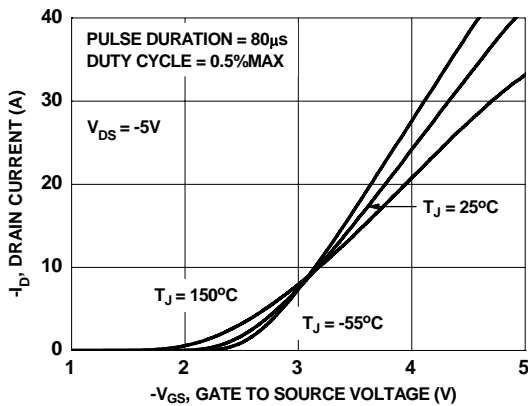

Figure 18. Transfer Characteristics

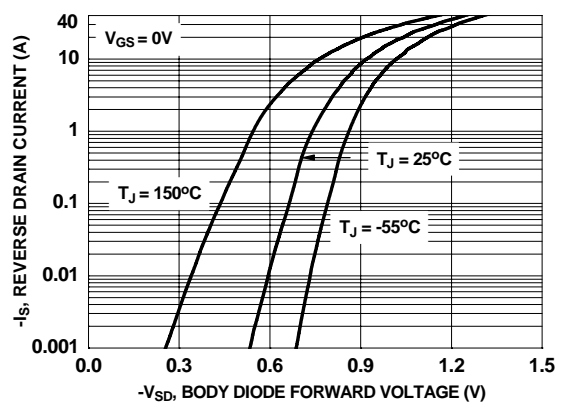

Figure 19. Source to Drain Diode Forward Voltage vs Source Current

Typical Characteristics (Q2 P-Channel) $T_J = 25^\circ\text{C}$ unless otherwise noted

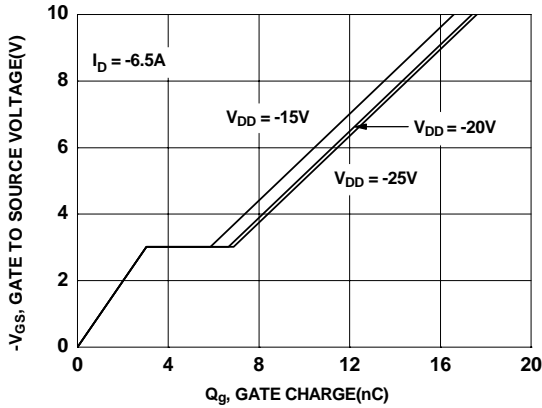

Figure 20. Gate Charge Characteristics

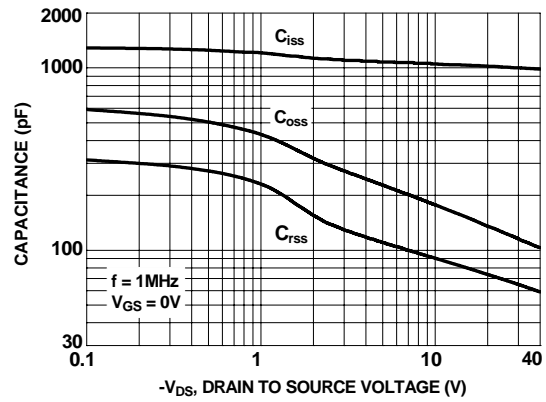

Figure 21. Capacitance vs Drain to Source Voltage

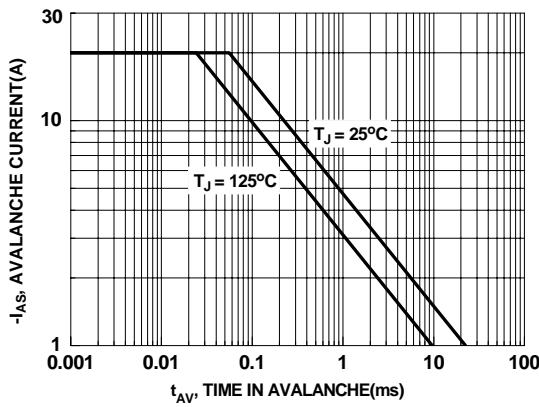

Figure 22. Unclamped Inductive Switching Capability

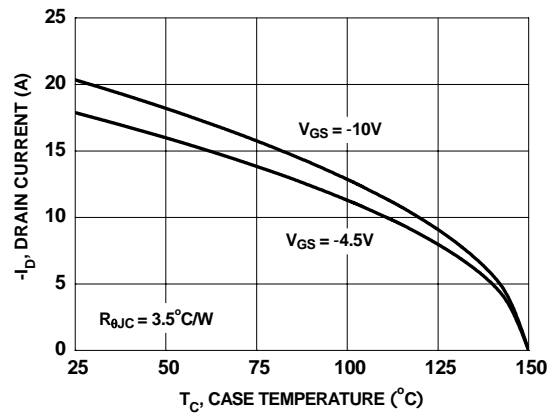

Figure 23. Maximum Continuous Drain Current vs Case Temperature

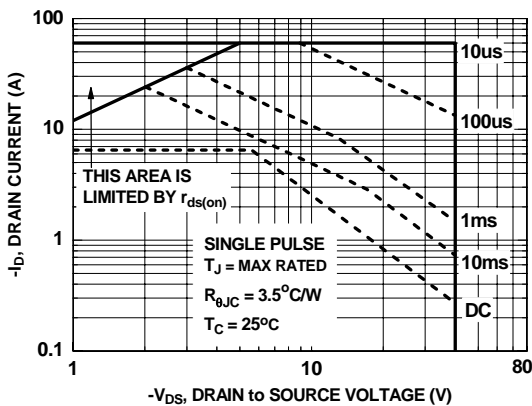

Figure 24. Forward Bias Safe Operating Area

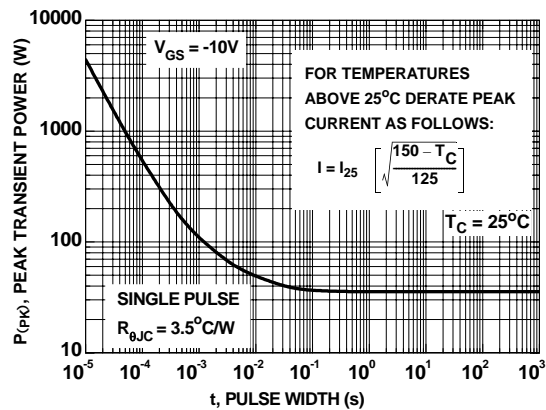
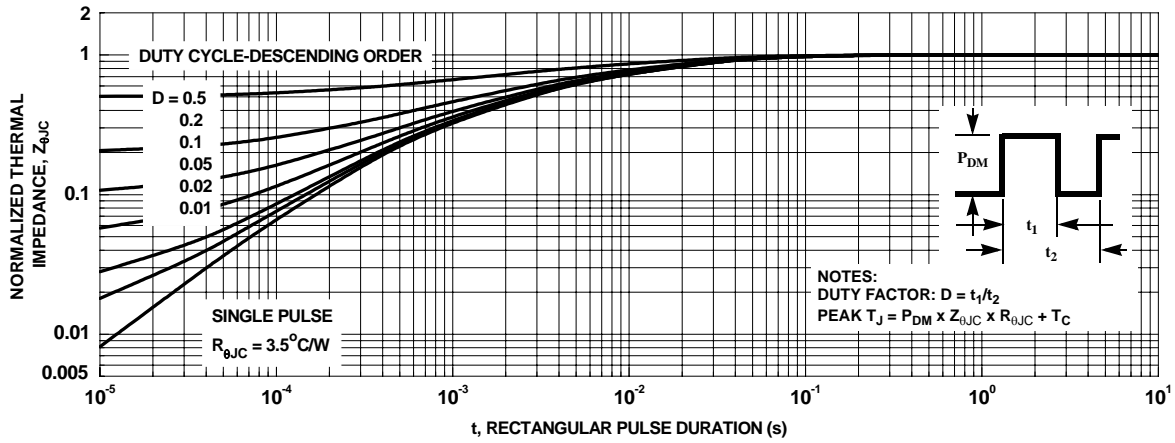
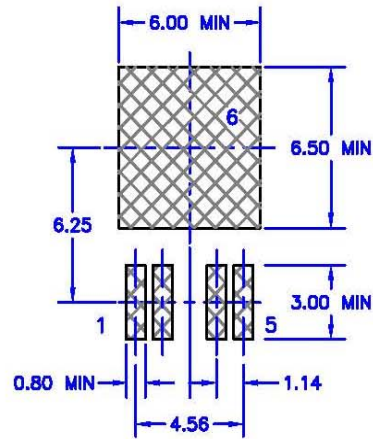
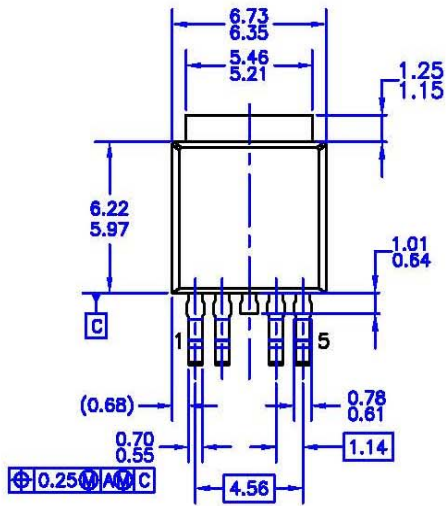

Figure 25. Single Pulse Maximum Power Dissipation

Typical Characteristics (Q2 P-Channel) $T_J = 25^\circ\text{C}$ unless otherwise noted





LAND PATTERN RECOMMENDATION

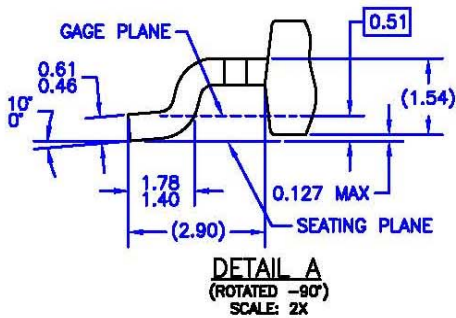
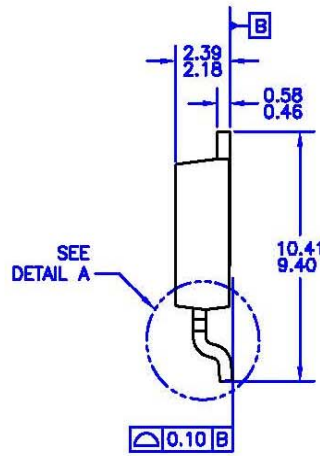
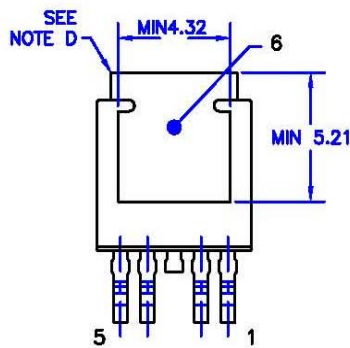

- NOTES: UNLESS OTHERWISE SPECIFIED
- A) THIS PACKAGE CONFORMS TO JEDEC, TO-252 ISSUE E, VARIATION AD, DATED JUNE, 2004.
 - B) ALL DIMENSIONS ARE IN MILLIMETERS.
 - C) DIMENSIONS ARE EXCLUSIVE OF BURRS, MOLD FLASH, AND TIE BAR EXTRUSIONS.
 - D) HEAT SINK TOP EDGE COULD BE IN CHAMFERD CORNERS OR EDGE PROTRUSION.
 - E) DIMENSIONS AND TOLERANCES PER ASME Y14.5M-1994



TRADEMARKS

The following are registered and unregistered trademarks Fairchild Semiconductor owns or is authorized to use and is not intended to be an exhaustive list of all such trademarks.

ACE [®]	HiSeC [™]	Programmable Active Droop [™]	TinyLogic [®]
Across the board. Around the world. [™]	<i>i-Lo</i> [™]	QFET [®]	TINYOPTO [™]
ActiveArray [™]	ImpliedDisconnect [™]	QS [™]	TinyPower [™]
Bottomless [™]	IntelliMAX [™]	QT Optoelectronics [™]	TinyWire [™]
Build it Now [™]	ISOPLANAR [™]	Quiet Series [™]	TruTranslation [™]
CoolFET [™]	MICROCOUPLER [™]	RapidConfigure [™]	µSerDes [™]
CROSSVOLT [™]	MicroPak [™]	RapidConnect [™]	UHC [®]
CTL [™]	MICROWIRE [™]	ScalarPump [™]	UniFET [™]
Current Transfer Logic [™]	MSX [™]	SMART START [™]	VCX [™]
DOME [™]	MSXPro [™]	SPM [®]	Wire [™]
E ² CMOS [™]	OCX [™]	STEALTH [™]	
EcoSPARK [®]	OCXPro [™]	SuperFET [™]	
EnSigna [™]	OPTOLOGIC [®]	SuperSOT [™] -3	
FACT Quiet Series [™]	OPTOPLANAR [®]	SuperSOT [™] -6	
FACT [®]	PACMAN [™]	SuperSOT [™] -8	
FAST [®]	POP [™]	SyncFET [™]	
FAST _r [™]	Power220 [®]	TCM [™]	
FPS [™]	Power247 [®]	The Power Franchise [®]	
FRFET [®]	PowerEdge [™]	 ™	
GlobalOptoisolator [™]	PowerSaver [™]	TinyBoost [™]	
GTO [™]	PowerTrench [®]	TinyBuck [™]	

DISCLAIMER

FAIRCHILD SEMICONDUCTOR RESERVES THE RIGHT TO MAKE CHANGES WITHOUT FURTHER NOTICE TO ANY PRODUCTS HEREIN TO IMPROVE RELIABILITY, FUNCTION OR DESIGN. FAIRCHILD DOES NOT ASSUME ANY LIABILITY ARISING OUT OF THE APPLICATION OR USE OF ANY PRODUCT OR CIRCUIT DESCRIBED HEREIN; NEITHER DOES IT CONVEY ANY LICENSE UNDER ITS PATENT RIGHTS, NOR THE RIGHTS OF OTHERS. THESE SPECIFICATIONS DO NOT EXPAND THE TERMS OF FAIRCHILD'S WORLDWIDE TERMS AND CONDITIONS, SPECIFICALLY THE WARRANTY THEREIN, WHICH COVERS THESE PRODUCTS.

LIFE SUPPORT POLICY

FAIRCHILD'S PRODUCTS ARE NOT AUTHORIZED FOR USE AS CRITICAL COMPONENTS IN LIFE SUPPORT DEVICES OR SYSTEMS WITHOUT THE EXPRESS WRITTEN APPROVAL OF FAIRCHILD SEMICONDUCTOR CORPORATION.

As used herein:

1. Life support devices or systems are devices or systems which, (a) are intended for surgical implant into the body or (b) support or sustain life, and (c) whose failure to perform when properly used in accordance with instructions for use provided in the labeling, can be reasonably expected to result in a significant injury of the user.
2. A critical component in any component of a life support device, or system whose failure to perform can be reasonably expected to cause the failure of the life support device or system, or to affect its safety or effectiveness.

PRODUCT STATUS DEFINITIONS

Definition of Terms

Datasheet Identification	Product Status	Definition
Advance Information	Formative or In Design	This datasheet contains the design specifications for product development. Specifications may change in any manner without notice.
Preliminary	First Production	This datasheet contains preliminary data; supplementary data will be published at a later date. Fairchild Semiconductor reserves the right to make changes at any time without notice to improve design.
No Identification Needed	Full Production	This datasheet contains final specifications. Fairchild Semiconductor reserves the right to make changes at any time without notice to improve design.
Obsolete	Not In Production	This datasheet contains specifications on a product that has been discontinued by Fairchild Semiconductor. The datasheet is printed for reference information only.