

Silicon Temperature Sensors

| | |
|----------|----------|
| KT 100 | KTY 10-x |
| KT 110 | KTY 11-x |
| KT 130 | KTY 13-x |
| KT 210 | KTY 21-x |
| KT 230 | KTY 23-x |
| KTY 16-6 | KTY 19-6 |

Features

- Temperature dependent resistor with positive temperature coefficient
- Temperature range – 50 °C to + 150 °C (– 60 F to 300 F)
- Available in SMD or leaded or customized packages
- Linear output
- Excellent longterm stability
- Polarity independent due to symmetrical construction
- Fast response time
- Resistance tolerances (R_{25}) of $\pm 3\%$ or $\pm 1\%$

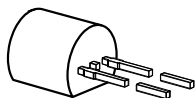

Modified TO-92

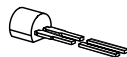

TO-92 Mini

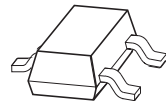

SOT-23

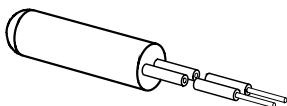

KTY 16-6

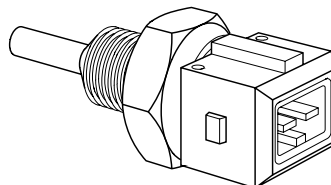

KTY 19-6

Standard Packages

| Type | Marking | Ordering Code | $R_{25 \text{ min}}$ | $R_{25 \text{ max}}$ | Package |
|-----------|-----------|---------------|--|----------------------|----------------------|
| | | | (in Ω with $I_{\text{op}} = 1 \text{ mA}$) | | |
| KT 100 | KT 100 | Q62705-K331 | 1940 | 2060 | TO-92 |
| KT 110 | T1 | Q62705-K332 | 1940 | 2060 | TO-92 Mini |
| KT 130 | T1 | Q62705-K333 | 1940 | 2060 | SOT-23 ¹⁾ |
| KT 210 | N1 | Q62705-K334 | 970 | 1030 | TO-92 Mini |
| KT 230 | N1 | Q62705-K335 | 970 | 1030 | SOT-23 ¹⁾ |
| KTY 10-5 | KTY 10-5 | Q62705-K110 | 1950 | 1990 | TO-92 |
| KTY 10-6 | KTY 10-6 | Q62705-K132 | 1980 | 2020 | TO-92 |
| KTY 10-62 | KTY 10-62 | Q62705-K71 | 1990 | 2010 | TO-92 |
| KTY 10-7 | KTY 10-7 | Q62705-K111 | 2010 | 2050 | TO-92 |
| KTY 11-5 | T5 | Q62705-K245 | 1950 | 1990 | TO-92 Mini |
| KTY 11-6 | T6 | Q62705-K246 | 1980 | 2020 | TO-92 Mini |
| KTY 11-7 | T7 | Q62705-K247 | 2010 | 2050 | TO-92 Mini |
| KTY 13-5 | T5 | Q62705-K249 | 1950 | 1990 | SOT-23 ¹⁾ |
| KTY 13-6 | T6 | Q62705-K250 | 1980 | 2020 | SOT-23 ¹⁾ |
| KTY 13-7 | T7 | Q62705-K251 | 2010 | 2050 | SOT-23 ¹⁾ |
| KTY 21-5 | N5 | Q62705-K258 | 975 | 995 | TO-92 Mini |
| KTY 21-6 | N6 | Q62705-K259 | 990 | 1010 | TO-92 Mini |
| KTY 21-7 | N7 | Q62705-K260 | 1005 | 1025 | TO-92 Mini |
| KTY 23-5 | N5 | Q62705-K262 | 975 | 995 | SOT-23 ¹⁾ |
| KTY 23-6 | N6 | Q62705-K263 | 990 | 1010 | SOT-23 ¹⁾ |
| KTY 23-7 | N7 | Q62705-K264 | 1005 | 1025 | SOT-23 ¹⁾ |

Custom Packages

| Type | Marking | Ordering Code | $R_{25 \text{ min}}$ | $R_{25 \text{ max}}$ | Screw Thread |
|--------------------------|---------|---------------|--|----------------------|--------------|
| | | | (in Ω with $I_{\text{op}} = 1 \text{ mA}$) | | |
| KTY 16-6 | none | Q62705-K128 | 1980 | 2020 | – |
| KTY 19-6M | KTY 19M | Q62705-K271 | 1980 | 2020 | ISO M10x1 |
| KTY 19-6Z | KTY 19Z | Q62705-K272 | 1980 | 2020 | NPTF 1/8x27 |
| Connector set for KTY 19 | | Q62901-B80 | | | |

¹⁾ Electrical contact between Pin1 and Pin2 (refer to package outlines drawing).

Absolute Maximum Ratings

| Parameter | Symbol | KT 1x0 KTY 1x-x | KT 2x0 KTY 2x-x | Unit |
|---|--------------------|--------------------|--------------------|------|
| Maximum operating voltage ¹⁾ $T_A \leq 25\text{ °C}, t \leq 10\text{ ms}$ | V_{opmax} | 25 | | V |
| Maximum operating current | I_{opmax} | 5 | 7 | mA |
| Peak operating current $T_A \leq 25\text{ °C}, t \leq 10\text{ ms}$ | I_{opp} | 7 | 10 | mA |
| Operating temperature range | T_{op} | - 50 ... + 150 | | °C |
| Storage temperature range | T_{stg} | - 50 ... + 150 | | °C |

¹⁾ When the temperature sensor is operated with long supply leads, it should be protected through the parallel connection of a > 10 nF capacitor to prevent damage to the sensor through induced voltage peaks.

Electrical Characteristics

$$I_{\text{op}} = 1\text{ mA}$$

| Thermal Time Constant (τ); (63% of ΔT) | τ_{air} (typ.) | τ_{oil} (typ.) | Unit |
|--|----------------------------|----------------------------|------|
| KT 100, KTY 10-x | 40 | 4 | s |
| KT 110, KT 210, KTY 11-x, KTY 21-x | 11 | 1.5 | |
| KT 130, KT 230, KTY 13-x, KTY 23-x | 7 | 1 | |
| KTY 16-6 | 40 | 4 | |
| KTY 19-6M/Z | 40 | 4 | |

General Technical Data: KT- and KTY-Series Temperature Sensors

These temperature sensors are designed for the measurement, control and regulation of air, gases and liquids within the temperature range of -50 °C to $+150\text{ °C}$. The temperature sensing element is an n-conducting silicon crystal in planar technology. The gentle curvature of the characteristic, $R_T = f(T_A)$, is described as a regression parabola in the following expressions.

The resistance of the sensor can be calculated for various temperatures from the following second order equation, valid over the temperature range -30 °C to $+130\text{ °C}$.

$$R_T = R_{25} \times (1 + \alpha \times \Delta T_A + \beta \times \Delta T_A^2) = f(T_A)$$

$$\text{with: } \alpha = 7.88 \cdot 10^{-3} \text{ K}^{-1}; \beta = 1.937 \cdot 10^{-5} \text{ K}^{-2}$$

The temperature factor k_T can be derived from this:

$$k_T = \frac{R_T}{R_{25}} = 1 + \alpha \times \Delta T_A + \beta \times \Delta T_A^2 = f(T_A)$$

The temperature at the sensor can be calculated from the change in the sensors resistance from the following equation, which approximates the characteristic curve.

$$T = \left(25 + \frac{\sqrt{\alpha^2 - 4 \times \beta + 4 \times \beta \times k_T} - \alpha}{2 \times \beta} \right) \text{°C}$$

Table 1
Spread of the Temperature Factor k_T

| T_A °C | k_T | | |
|-------------|-------------------|-------|-------|
| | min. | typ. | max. |
| - 50 | 0.506 | 0.518 | 0.530 |
| - 40 | 0.559 | 0.570 | 0.581 |
| - 30 | 0.615 | 0.625 | 0.635 |
| - 20 | 0.676 | 0.685 | 0.694 |
| - 10 | 0.741 | 0.748 | 0.755 |
| 0 | 0.810 | 0.815 | 0.821 |
| 10 | 0.883 | 0.886 | 0.890 |
| 20 | 0.960 | 0.961 | 0.962 |
| 25 | 1.0 ¹⁾ | | |
| 30 | 1.039 | 1.040 | 1.041 |
| 40 | 1.119 | 1.123 | 1.126 |
| 50 | 1.204 | 1.209 | 1.215 |
| 60 | 1.291 | 1.300 | 1.308 |
| 70 | 1.383 | 1.394 | 1.405 |
| 80 | 1.478 | 1.492 | 1.506 |
| 90 | 1.577 | 1.594 | 1.611 |
| 100 | 1.680 | 1.700 | 1.720 |
| 110 | 1.786 | 1.810 | 1.833 |
| 120 | 1.896 | 1.923 | 1.951 |
| 130 | 2.010 | 2.041 | 2.072 |
| 140 | 2.093 | 2.128 | 2.163 |
| 150 | 2.196 | 2.235 | 2.274 |

1) Normalising point

Sensor Resistance $R_T = k_T \times R_{25} = f(T_A)$

$I_B = 1 \text{ mA}$; Example: $R_{25} = 2000 \ \Omega$

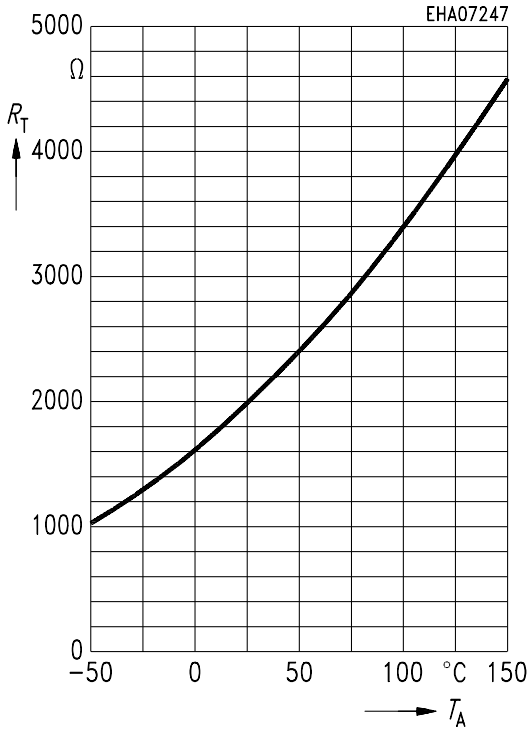

Sensor Resistance $R_T = k_T \times R_{25} = f(T_A)$

$I_B = 1 \text{ mA}$; Example: $R_{25} = 1000 \ \Omega$

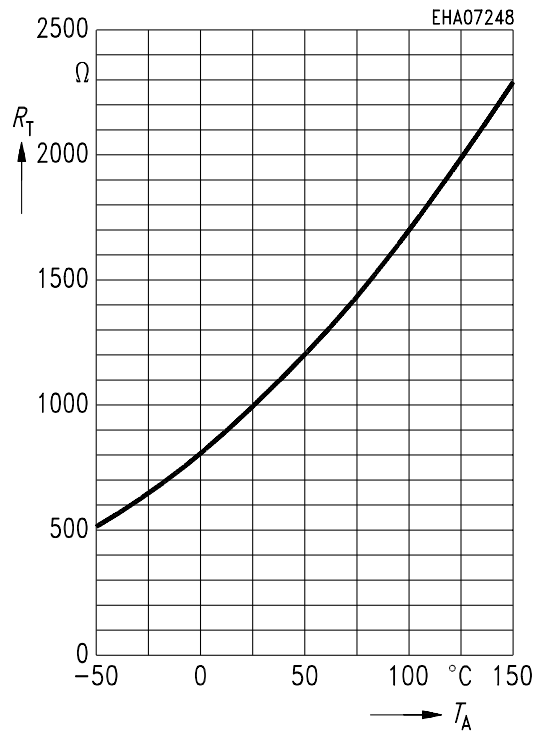

Typical Dependence of Sensor Resistance on Supply Current

Example: KTY 10-6 in oil at $T_A = 25 \text{ °C}$

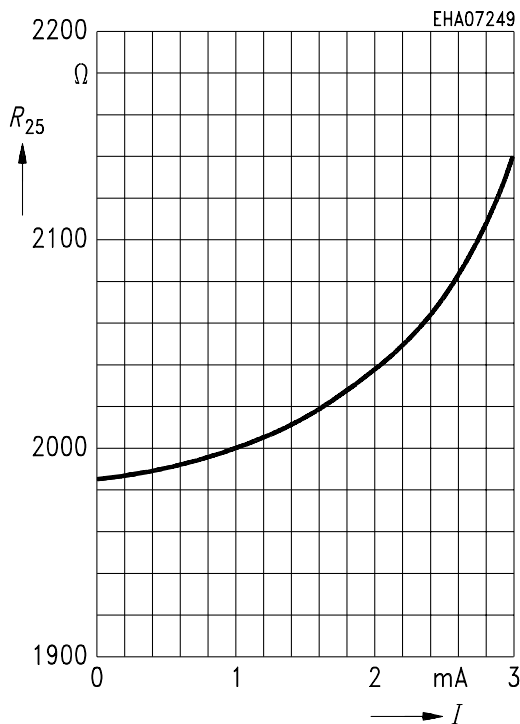

Typical Dependence of Sensor Resistance on Supply Current

Example: KTY 21-6 in oil at $T_A = 25 \text{ °C}$

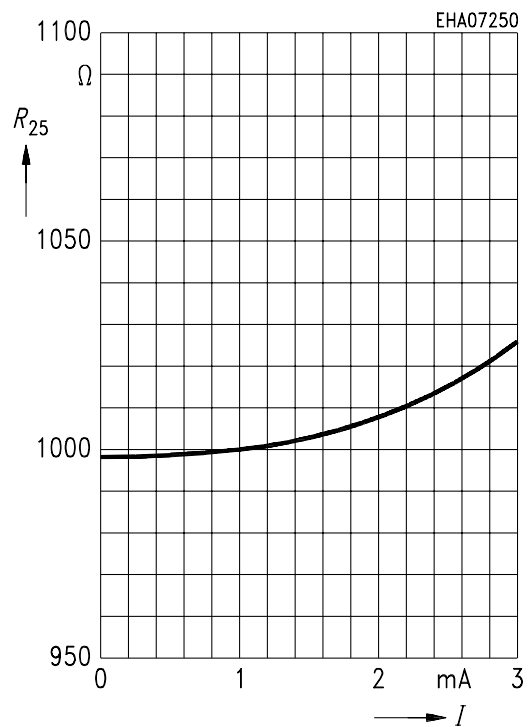

Typical Deviation of Sensor Resistance from the Basic Resistance R_{25} ($I_B = 1\text{mA}$) Versus Supply Current

Example: KTY 10-6 in oil at $T_A = 25\text{ }^\circ\text{C}$

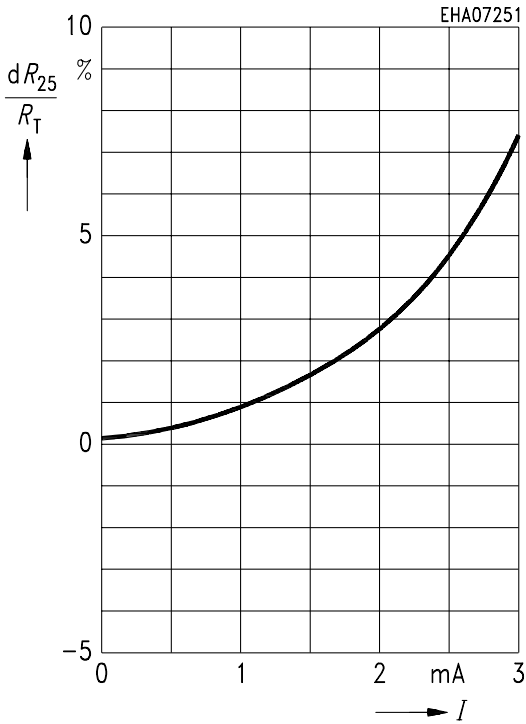

Typical Deviation of Sensor Resistance from the Basic Resistance R_{25} ($I_B = 1\text{mA}$) Versus Supply Current

Example: KTY 21-6 in oil at $T_A = 25\text{ }^\circ\text{C}$

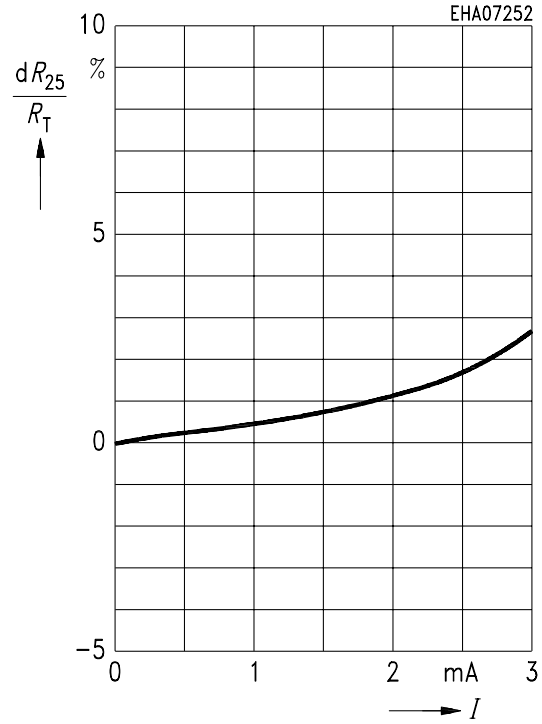

Typical Relationship of the Temperature Factor

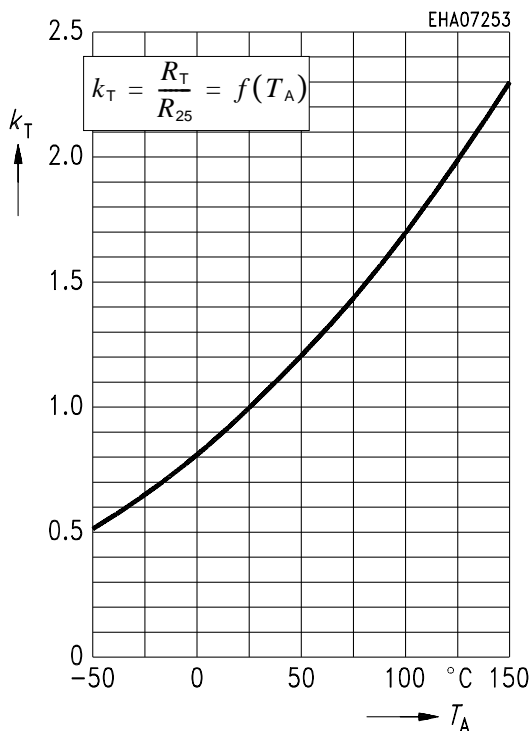

Typical Relationship of the Temperature Factor

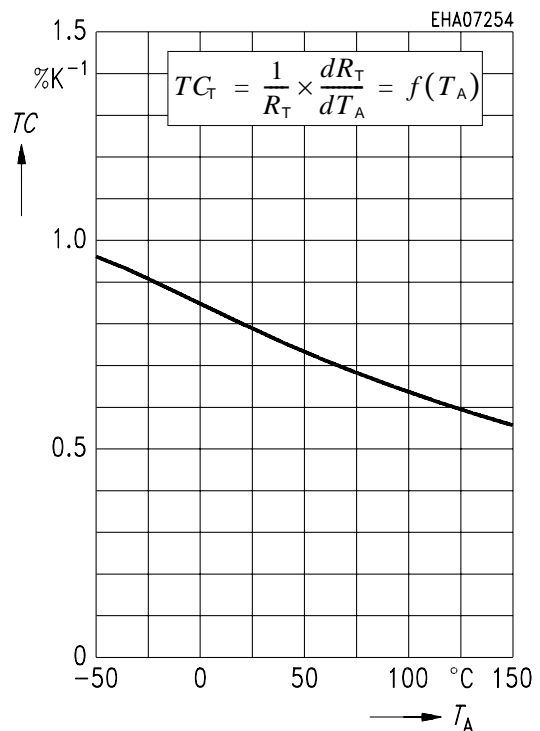

Definition of the Thermal Time Constant τ

$$\Delta T_A = T_{A2} - T_{A1}; \tau = t_1 - t_0$$

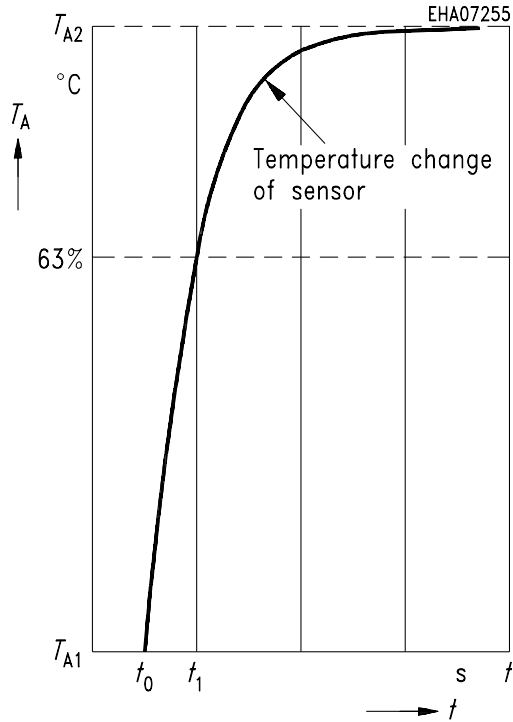

Thermal Time constant

$$\tau = 5 \text{ s}$$

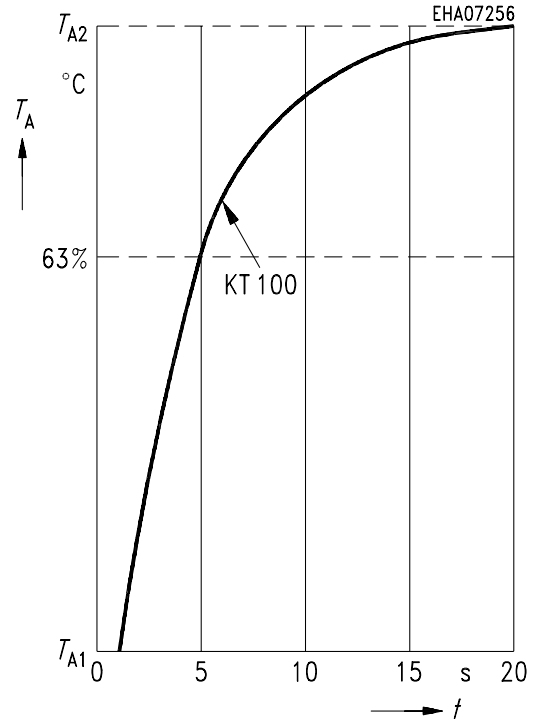

Peak Current in Air

$$R_{25} = 2000 \Omega; \hat{I} = f(T_A)$$

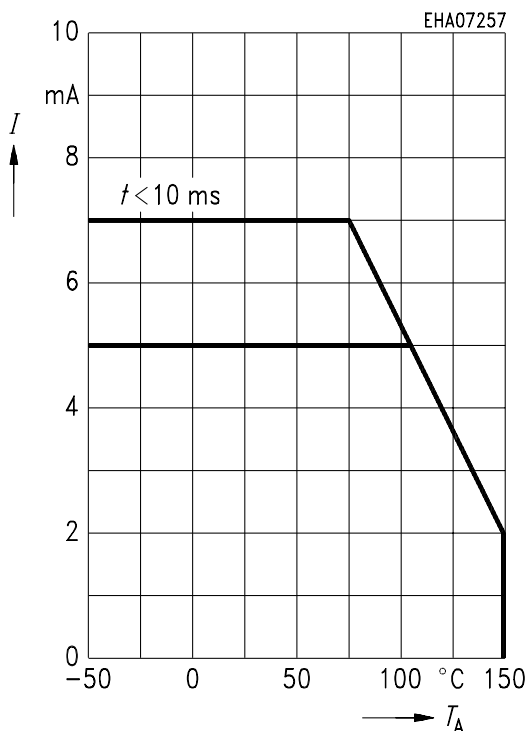

Peak Current in Air

$$R_{25} = 1000 \Omega; \hat{I} = f(T_A)$$

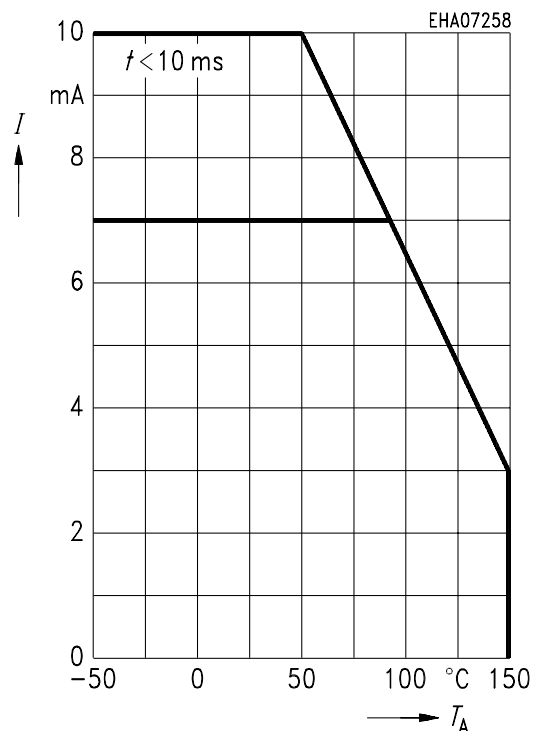

Package Outlines

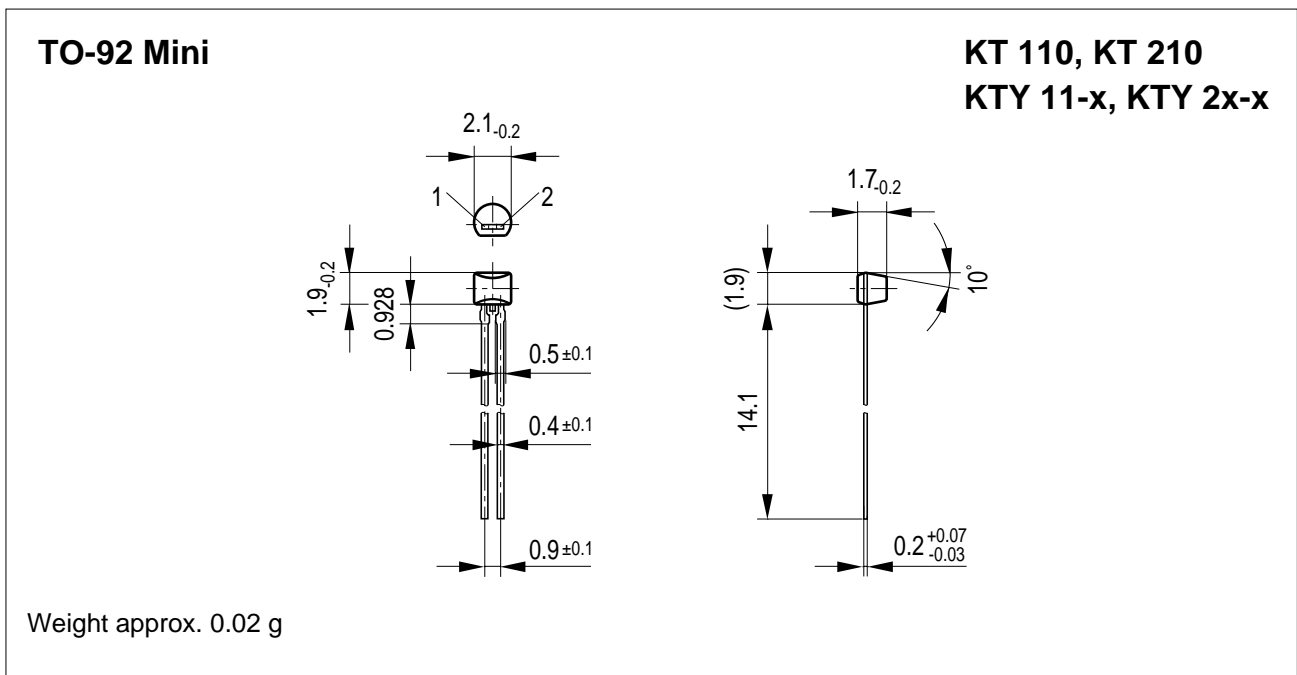
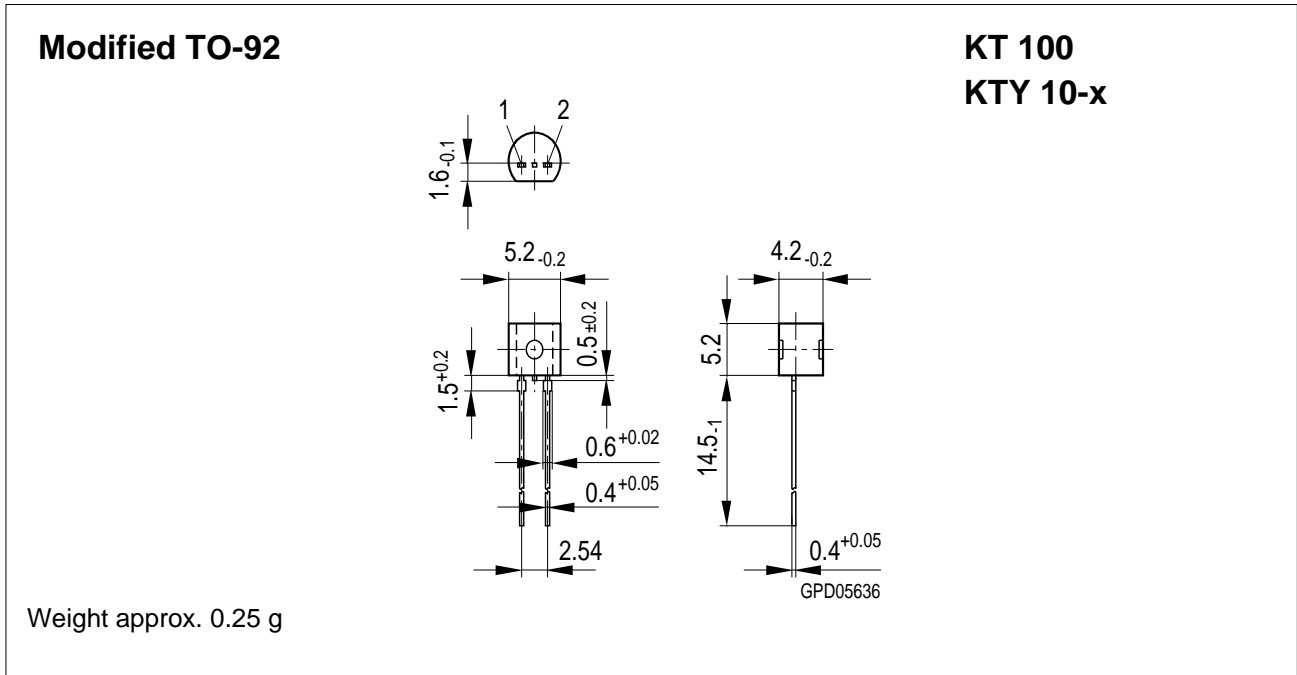

Sorts of Packing

Package outlines for tubes, trays etc. are contained in our Data Book "Package Information".

Dimensions in mm

SOT-23 (Small Outline Transistor)

KT 130, KT 230
KTY 13-x, KTY 23-x

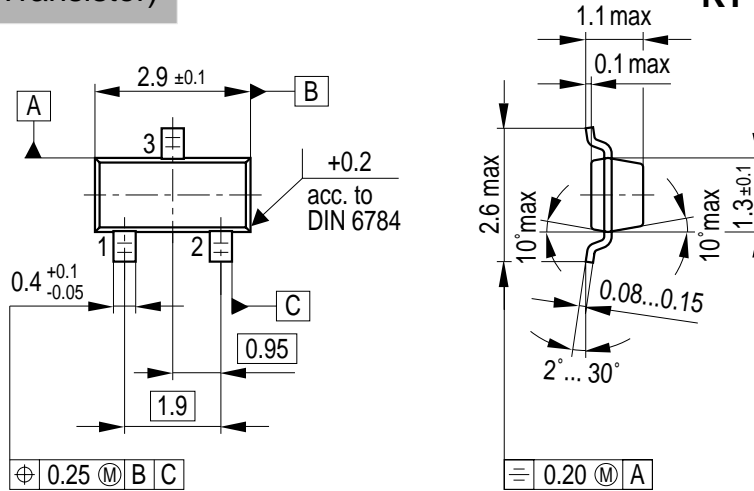

Weight approx. 0.01 g

Pins 1 - 2: R_{25}

Ni-plated Brass Tube Housing with Tefzel Isolated Leadwires

KTY 16-6

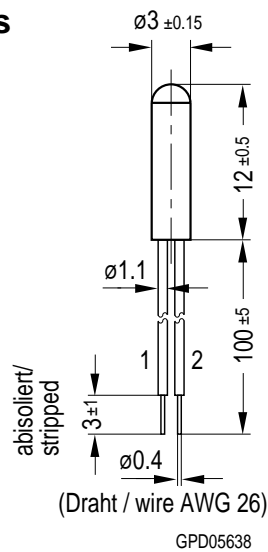

Weight approx. 0.07 g

Sorts of Packing

Package outlines for tubes, trays etc. are contained in our Data Book "Package Information".

SMD = Surface Mounted Device

Dimensions in mm

Stainless Steel Housing, BSS303 (equiv. DIN 1.4305)

KTY 19-6M/Z

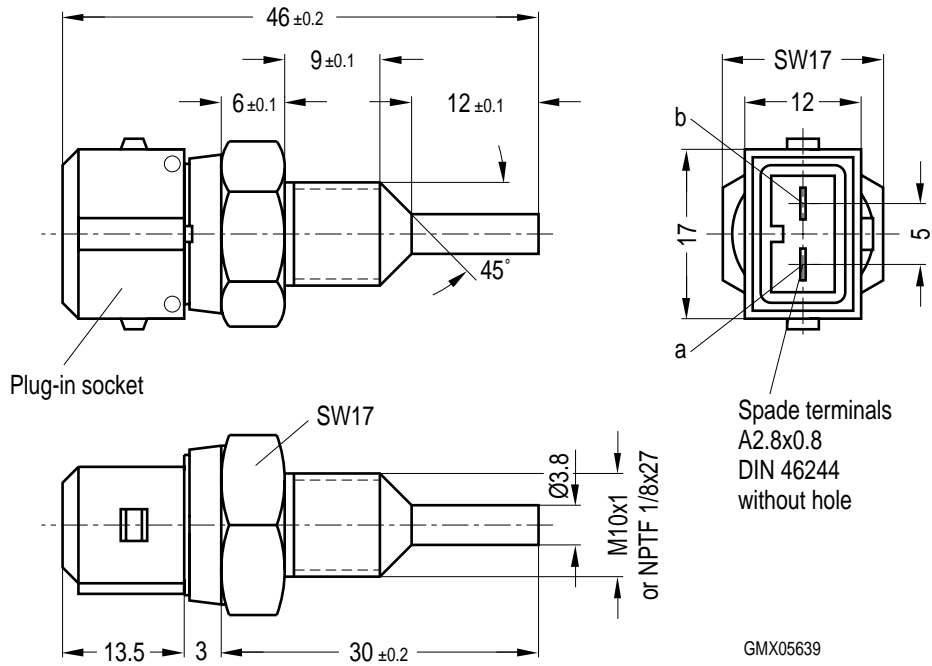

Weight approx. 20 g

Sorts of Packing

Package outlines for tubes, trays etc. are contained in our Data Book "Package Information".

Dimensions in mm