

DS26LV31T 3V Enhanced CMOS Quad Differential Line Driver

Check for Samples: [DS26LV31T](#)

FEATURES

- Industrial Product Meets TIA/EIA-422-B (RS-422) and ITU-T V.11 Recommendation
- Military Product Conforms to TIA/EIA-422-B (RS-422)
- Interoperable with Existing 5V RS-422 Networks
- Industrial and Military temperature Range
- Guaranteed V_{OD} of 2V min Over Operating Conditions
- Balanced Output Crossover for Low EMI (Typical Within 40 mV of 50% Voltage Level)
- Low Power Design (330 μ W @ 3.3V static)
- ESD \geq 7 kV on Cable I/O Pins (HBM)
- Guaranteed AC Parameter:
 - Maximum Driver Skew: 2 ns
 - Maximum Transition Time: 10 ns
- Pin Compatible with DS26C31
- Available in SOIC and CLGA Packaging

- Standard Microcircuit Drawing (SMD) 5962-98584

DESCRIPTION

The DS26LV31T is a high-speed quad differential CMOS driver that meets the requirements of both TIA/EIA-422-B and ITU-T V.11. The CMOS DS26LV31T features low static I_{CC} of 100 μ A MAX which makes it ideal for battery powered and power conscious applications.

Differential outputs have the same V_{OD} guarantee (\geq 2V) as the 5V version.

The EN and EN* inputs allow active Low or active High control of the TRI-STATE outputs. The enables are common to all four drivers. Protection diodes protect all the driver inputs against electrostatic discharge. Outputs have enhanced ESD protection providing greater than 7 kV tolerance. The driver and enable inputs (DI, EN, EN*) are compatible with low voltage LVTTTL and LVCMOS devices.

Connection Diagram

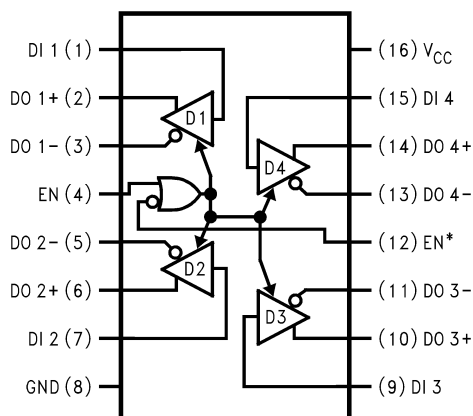

**Figure 1. Dual-In-Line Package
Top View
See Package D (R-PDSO-G16)**



Please be aware that an important notice concerning availability, standard warranty, and use in critical applications of Texas Instruments semiconductor products and disclaimers thereto appears at the end of this data sheet.

All trademarks are the property of their respective owners.

Truth Table⁽¹⁾

Enables		Input	Outputs	
EN	EN*	DI	DO+	DO-
L	H	X	Z	Z
All other combinations of enable inputs		L	L	H
		H	H	L

- (1) L = Low logic state
 X = Irrelevant
 H = High logic state
 Z = TRI-STATE



These devices have limited built-in ESD protection. The leads should be shorted together or the device placed in conductive foam during storage or handling to prevent electrostatic damage to the MOS gates.

Absolute Maximum Ratings⁽¹⁾⁽²⁾

Supply Voltage (V_{CC})	-0.5V to +7V
Enable Input Voltage (EN, EN*)	-0.5V to $V_{CC} + 0.5V$
Driver Input Voltage (DI)	-0.5V to $V_{CC} + 0.5V$
Clamp Diode Current	±20 mA
DC Output Current, per pin	±150 mA
Driver Output Voltage	
(Power Off: DO+, DO-)	-0.5V to +7V
Maximum Package Power Dissipation @+25°C	
D0016A Package	1226 mW
NAD0016A Package	1119 mW
Derate D0016A Package 9.8 mW/°C above +25°C	
Derate NAD0016A Package 7.5 mW/°C above +25°C	
Storage Temperature Range	-65°C to +150°C
Lead Temperature Range Soldering (4 sec.)	+260°C
ESD Ratings (HBM, 1.5 kΩ, 100 pF)	
Driver Outputs	≥7 kV
Other Pins	≥2.5 kV

- (1) "Absolute Maximum Ratings" are those values beyond which the safety of the device cannot be guaranteed. They are not meant to imply that the devices should be operated at these limits. The [Electrical Characteristics](#) specifies conditions of device operation.
 (2) If Military/Aerospace specified devices are required, please contact the TI Sales Office/Distributors for availability and specifications.

Recommended Operating Conditions

	Min	Typ	Max	Units
Supply Voltage (V_{CC})	3.0	3.3	3.6	V
Operating Free Air Temperature Range (T_A)				
DS26LV31T	-40	+25	+85	°C
DS26LV31W	-55	+25	+125	°C
Input Rise and Fall Time			500	ns

Electrical Characteristics^{(1) (2)}

Over supply voltage and operating temperature ranges, unless otherwise specified

Parameter		Test Conditions		Pin	Min	Typ	Max	Units
V _{OD1}	Output Differential Voltage	R _L = ∞ (No Load)		DO+, DO-		3.3	4	V
V _{OD2}	Output Differential Voltage	R _L = 100Ω (Figure 2)			2	2.6		V
ΔV _{OD2}	Change in Magnitude of Output Differential Voltage	I _O ≥ 20 mA			-400	7	400	mV
V _{OD3}	Output Differential Voltage	R _L = 3900Ω (V.11) Figure 2 and ⁽³⁾				3.2	3.6	V
V _{OC}	Common Mode Voltage	R _L = 100Ω (Figure 2)				1.5	2	V
ΔV _{OC}	Change in Magnitude of Common Mode Voltage				-400	6	400	mV
I _{OZ}	TRI-STATE Leakage Current	V _{OUT} = V _{CC} or GND Drivers Disabled				±0.5	±20	μA
I _{SC}	Output Short Circuit Current	V _{OUT} = 0V V _{IN} = V _{CC} or GND ⁽⁴⁾	T _A = -40°C to +85°C		-40	-70	-150	mA
			T _A = -55°C to +125°C ⁽⁵⁾		-30		-160	mA
I _{OFF}	Output Leakage Current	V _{CC} = 0V, V _{OUT} = 3V or 6V				0.03	100	μA
		V _{CC} = 0V, V _{OUT} = -0.25V	T _A = -40°C to +85°C			-0.08	-100	μA
			T _A = -55°C to +125°C				-200	μA
V _{IH}	High Level Input Voltage			DI, EN, EN*	2.0		V _{CC}	V
V _{IL}	Low Level Input Voltage				GND		0.8	V
I _{IH}	High Level Input Current	V _{IN} = V _{CC}					10	μA
I _{IL}	Low Level Input Current	V _{IN} = GND			-10			μA
V _{CL}	Input Clamp Voltage	I _{IN} = -18 mA					-1.5	V
I _{CC}	Power Supply Current	No Load, V _{IN} (all) = V _{CC} or GND			T _A = -40°C to +85°C	V _{CC}		100
				T _A = -55°C to +125°C			125	μA

- (1) Current into device pins is defined as positive. Current out of device pins is defined as negative. All voltages are referenced to ground except differential voltages V_{OD1}, V_{OD2}, V_{OD3}.
- (2) All typicals are given for V_{CC} = +3.3V, T_A = +25°C.
- (3) This specification limit is for compliance with TIA/EIA-422-B and ITU-T V.11.
- (4) Only one output shorted at a time. The output (true or complement) is configured High.
- (5) This parameter does not meet the TIA/EIA-422-B specification.

Switching Characteristics - Industrial^{(1) (2)}

Over supply voltage and -40°C to +85°C operating temperature range, unless otherwise specified

Parameter		Test Conditions		Min	Typ	Max	Units
t _{PHLD}	Differential Propagation Delay High to Low	R _L = 100Ω, C _L = 50 pF (Figure 3 and Figure 4)		6	10.5	16	ns
t _{PLHD}	Differential Propagation Delay Low to High			6	11	16	ns
t _{SKD}	Differential Skew (same channel) t _{PHLD} - t _{PLHD}				0.5	2.0	ns
t _{SK1}	Skew, Pin to Pin (same device)				1.0	2.0	ns
t _{SK2}	Skew, Part to Part ⁽³⁾				3.0	5.0	ns
t _{TLH}	Differential Transition Time Low to High (20% to 80%)				4.2	10	ns
t _{THL}	Differential Transition Time High to Low (80% to 20%)				4.7	10	ns
t _{PHZ}	Disable Time High to Z			(Figure 5 Figure 6)			12
t _{PLZ}	Disable Time Low to Z				9	20	ns

- (1) f = 1 MHz, t_r and t_f ≤ 6 ns, 10% to 90%.
- (2) See TIA/EIA-422-B specifications for exact test conditions.
- (3) Devices are at the same V_{CC} and within 5°C within the operating temperature range

Switching Characteristics - Industrial ⁽¹⁾ ⁽²⁾ (continued)

Over supply voltage and -40°C to +85°C operating temperature range, unless otherwise specified

Parameter		Test Conditions	Min	Typ	Max	Units
t _{PZH}	Enable Time Z to High			22	32	ns
t _{PZL}	Enable Time Z to Low			22	32	ns
f _{max}	Maximum Operating Frequency ⁽⁴⁾		32			MHz

(4) All channels switching, output duty cycle criteria is 40%/60% measured at 50%. This parameter is guaranteed by design and characterization.

Switching Characteristics - Military ⁽¹⁾ ⁽²⁾

Over supply voltage and -55°C to +125°C operating temperature range, unless otherwise specified

Parameter		Test Conditions	Min	Max	Units
t _{PHLD}	Differential Propagation Delay High to Low	R _L = 100Ω, C _L = 50 pF (Figure 3 Figure 4) (Figure 5 Figure 6)	5	25	ns
t _{PLHD}	Differential Propagation Delay Low to High		5	25	ns
t _{SKD}	Differential Skew (same channel) t _{PHLD} - t _{PLHD}			5.0	ns
t _{SK1}	Skew, Pin to Pin (same device)			5.0	ns
t _{PHZ}	Disable Time High to Z			35	ns
t _{PLZ}	Disable Time Low to Z			35	ns
t _{PZH}	Enable Time Z to High			40	ns
t _{PZL}	Enable Time Z to Low			40	ns

(1) f = 1 MHz, t_r and t_f ≤ 6 ns, 10% to 90%.

(2) See TIA/EIA-422-B specifications for exact test conditions.

PARAMETER MEASUREMENT INFORMATION

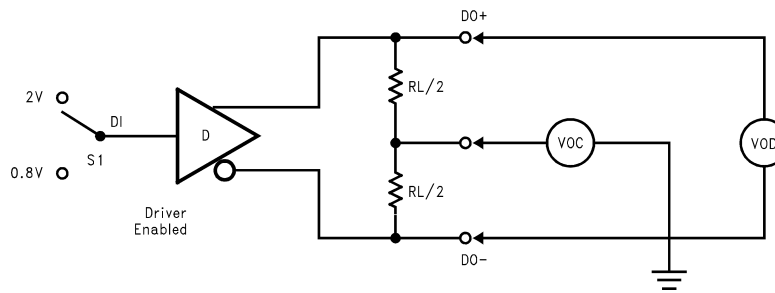

Figure 2. Differential Driver DC Test Circuit

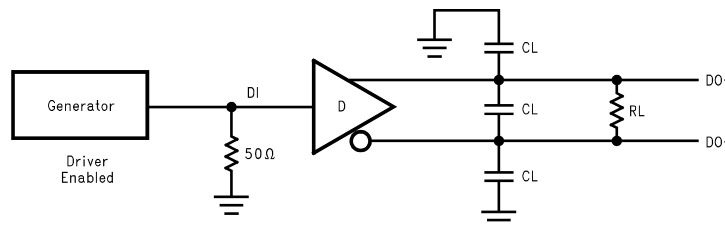
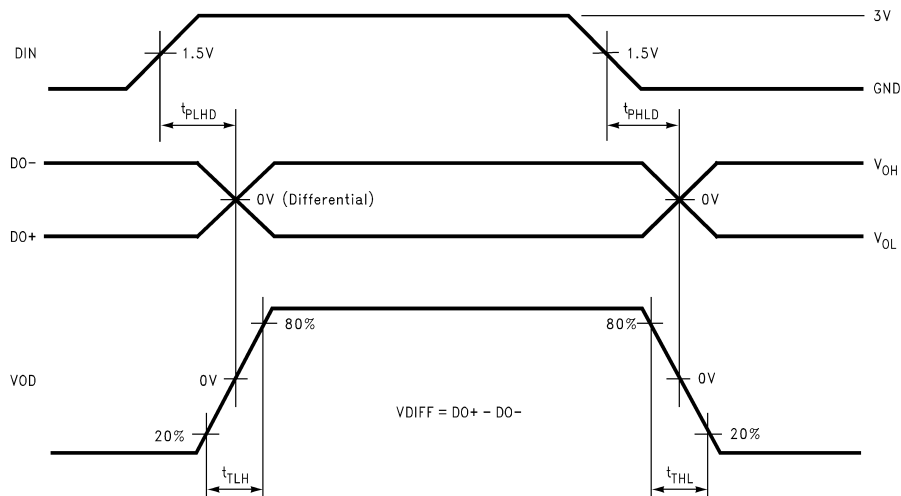
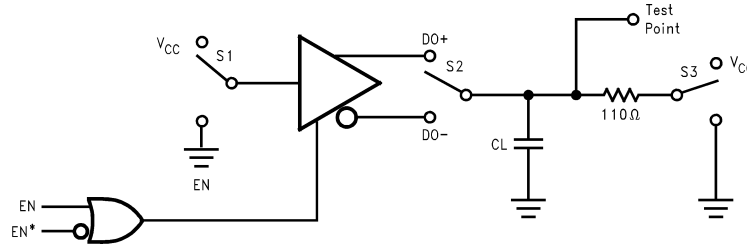

Figure 3. Differential Driver Propagation Delay and Transition Time Test Circuit



- A. Generator waveform for all tests unless otherwise specified: $f = 1 \text{ MHz}$, Duty Cycle = 50% $Z_0 = 50\Omega$, $t_r \leq 10 \text{ ns}$, $t_f \leq 10$.
- B. C_L includes probe and fixture capacitance.

Figure 4. Differential Driver Propagation Delay and Transition Time Waveforms



If EN is the input, then EN* = High
 If EN* is the input, then EN = Low

Figure 5. Driver Single-Ended TRI-STATE Test Circuit

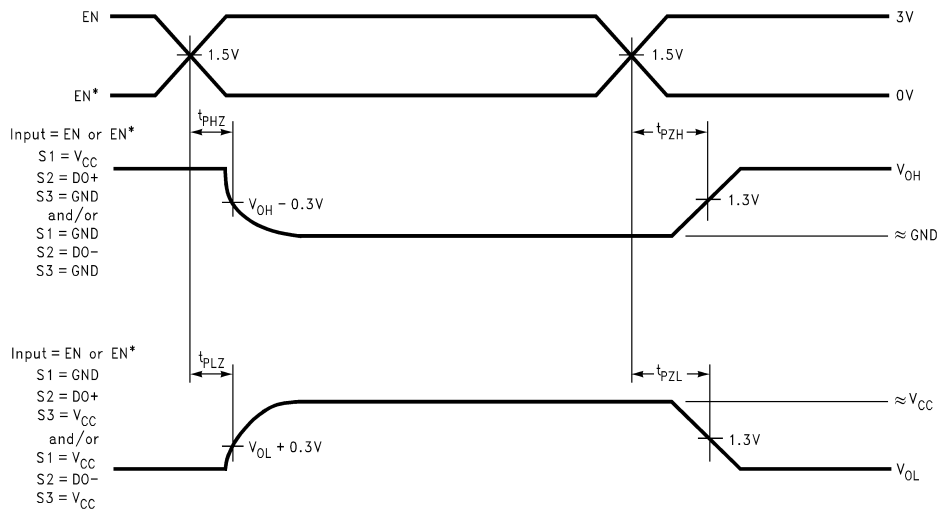

Figure 6. Driver Single-Ended TRI-STATE Waveforms

Typical Application Information

General application guidelines and hints for differential drivers and receivers may be found in the following application notes:

- AN-214
- AN-457
- AN-805
- AN-847
- AN-903
- AN-912
- AN-916

Power Decoupling Recommendations:

Bypass caps must be used on power pins. High frequency ceramic (surface mount is recommended) 0.1 μF in parallel with 0.01 μF at the power supply pin. A 10 μF or greater solid tantalum or electrolytic should be connected at the power entry point on the printed circuit board.

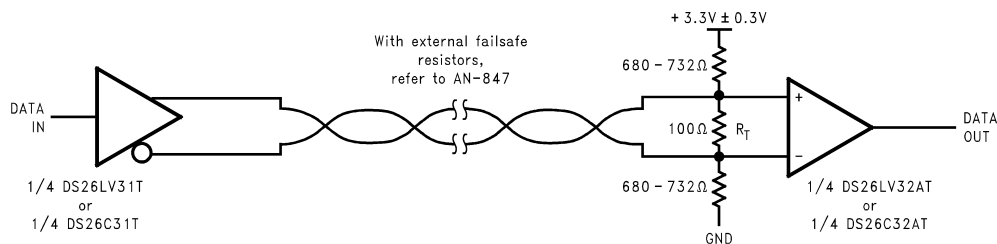
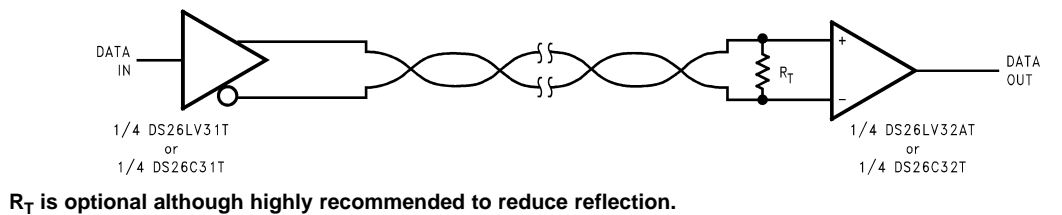

Figure 7. Typical Driver Connection

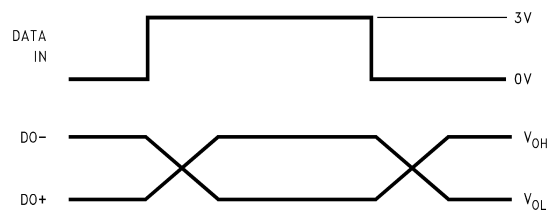

Figure 8. Typical Driver Output Waveforms

REVISION HISTORY

Changes from Revision B (February 2013) to Revision C	Page
• Changed layout of National Data Sheet to TI format	7

PACKAGING INFORMATION

Orderable Device	Status (1)	Package Type	Package Drawing	Pins	Package Qty	Eco Plan (2)	Lead/Ball Finish	MSL Peak Temp (3)	Op Temp (°C)	Top-Side Markings (4)	Samples
DS26LV31TM	ACTIVE	SOIC	D	16	48	TBD	Call TI	Call TI	-40 to 85	DS26LV31 TM	Samples
DS26LV31TM/NOPB	ACTIVE	SOIC	D	16	48	Green (RoHS & no Sb/Br)	CU SN	Level-1-260C-UNLIM	-40 to 85	DS26LV31 TM	Samples
DS26LV31TMX	ACTIVE	SOIC	D	16	2500	TBD	Call TI	Call TI	-40 to 85	DS26LV31 TM	Samples
DS26LV31TMX/NOPB	ACTIVE	SOIC	D	16	2500	Green (RoHS & no Sb/Br)	CU SN	Level-1-260C-UNLIM	-40 to 85	DS26LV31 TM	Samples

(1) The marketing status values are defined as follows:

ACTIVE: Product device recommended for new designs.

LIFEBUY: TI has announced that the device will be discontinued, and a lifetime-buy period is in effect.

NRND: Not recommended for new designs. Device is in production to support existing customers, but TI does not recommend using this part in a new design.

PREVIEW: Device has been announced but is not in production. Samples may or may not be available.

OBSELETE: TI has discontinued the production of the device.

(2) Eco Plan - The planned eco-friendly classification: Pb-Free (RoHS), Pb-Free (RoHS Exempt), or Green (RoHS & no Sb/Br) - please check <http://www.ti.com/productcontent> for the latest availability information and additional product content details.

TBD: The Pb-Free/Green conversion plan has not been defined.

Pb-Free (RoHS): TI's terms "Lead-Free" or "Pb-Free" mean semiconductor products that are compatible with the current RoHS requirements for all 6 substances, including the requirement that lead not exceed 0.1% by weight in homogeneous materials. Where designed to be soldered at high temperatures, TI Pb-Free products are suitable for use in specified lead-free processes.

Pb-Free (RoHS Exempt): This component has a RoHS exemption for either 1) lead-based flip-chip solder bumps used between the die and package, or 2) lead-based die adhesive used between the die and leadframe. The component is otherwise considered Pb-Free (RoHS compatible) as defined above.

Green (RoHS & no Sb/Br): TI defines "Green" to mean Pb-Free (RoHS compatible), and free of Bromine (Br) and Antimony (Sb) based flame retardants (Br or Sb do not exceed 0.1% by weight in homogeneous material)

(3) MSL, Peak Temp. -- The Moisture Sensitivity Level rating according to the JEDEC industry standard classifications, and peak solder temperature.

(4) Multiple Top-Side Markings will be inside parentheses. Only one Top-Side Marking contained in parentheses and separated by a "~" will appear on a device. If a line is indented then it is a continuation of the previous line and the two combined represent the entire Top-Side Marking for that device.

Important Information and Disclaimer: The information provided on this page represents TI's knowledge and belief as of the date that it is provided. TI bases its knowledge and belief on information provided by third parties, and makes no representation or warranty as to the accuracy of such information. Efforts are underway to better integrate information from third parties. TI has taken and continues to take reasonable steps to provide representative and accurate information but may not have conducted destructive testing or chemical analysis on incoming materials and chemicals. TI and TI suppliers consider certain information to be proprietary, and thus CAS numbers and other limited information may not be available for release.

In no event shall TI's liability arising out of such information exceed the total purchase price of the TI part(s) at issue in this document sold by TI to Customer on an annual basis.

TAPE AND REEL INFORMATION

QUADRANT ASSIGNMENTS FOR PIN 1 ORIENTATION IN TAPE

*All dimensions are nominal

Device	Package Type	Package Drawing	Pins	SPQ	Reel Diameter (mm)	Reel Width W1 (mm)	A0 (mm)	B0 (mm)	K0 (mm)	P1 (mm)	W (mm)	Pin1 Quadrant
DS26LV31TMX	SOIC	D	16	2500	330.0	16.4	6.5	10.3	2.3	8.0	16.0	Q1
DS26LV31TMX/NOPB	SOIC	D	16	2500	330.0	16.4	6.5	10.3	2.3	8.0	16.0	Q1

TAPE AND REEL BOX DIMENSIONS



*All dimensions are nominal



Device	Package Type	Package Drawing	Pins	SPQ	Length (mm)	Width (mm)	Height (mm)
DS26LV31TMX	SOIC	D	16	2500	367.0	367.0	35.0
DS26LV31TMX/NOPB	SOIC	D	16	2500	367.0	367.0	35.0

D (R-PDSO-G16)

PLASTIC SMALL OUTLINE



4040047-6/M 06/11

- NOTES:
- A. All linear dimensions are in inches (millimeters).
 - B. This drawing is subject to change without notice.
 -  Body length does not include mold flash, protrusions, or gate burrs. Mold flash, protrusions, or gate burrs shall not exceed 0.006 (0,15) each side.
 -  Body width does not include interlead flash. Interlead flash shall not exceed 0.017 (0,43) each side.
 - E. Reference JEDEC MS-012 variation AC.

IMPORTANT NOTICE

Texas Instruments Incorporated and its subsidiaries (TI) reserve the right to make corrections, enhancements, improvements and other changes to its semiconductor products and services per JESD46, latest issue, and to discontinue any product or service per JESD48, latest issue. Buyers should obtain the latest relevant information before placing orders and should verify that such information is current and complete. All semiconductor products (also referred to herein as "components") are sold subject to TI's terms and conditions of sale supplied at the time of order acknowledgment.

TI warrants performance of its components to the specifications applicable at the time of sale, in accordance with the warranty in TI's terms and conditions of sale of semiconductor products. Testing and other quality control techniques are used to the extent TI deems necessary to support this warranty. Except where mandated by applicable law, testing of all parameters of each component is not necessarily performed.

TI assumes no liability for applications assistance or the design of Buyers' products. Buyers are responsible for their products and applications using TI components. To minimize the risks associated with Buyers' products and applications, Buyers should provide adequate design and operating safeguards.

TI does not warrant or represent that any license, either express or implied, is granted under any patent right, copyright, mask work right, or other intellectual property right relating to any combination, machine, or process in which TI components or services are used. Information published by TI regarding third-party products or services does not constitute a license to use such products or services or a warranty or endorsement thereof. Use of such information may require a license from a third party under the patents or other intellectual property of the third party, or a license from TI under the patents or other intellectual property of TI.

Reproduction of significant portions of TI information in TI data books or data sheets is permissible only if reproduction is without alteration and is accompanied by all associated warranties, conditions, limitations, and notices. TI is not responsible or liable for such altered documentation. Information of third parties may be subject to additional restrictions.

Resale of TI components or services with statements different from or beyond the parameters stated by TI for that component or service voids all express and any implied warranties for the associated TI component or service and is an unfair and deceptive business practice. TI is not responsible or liable for any such statements.

Buyer acknowledges and agrees that it is solely responsible for compliance with all legal, regulatory and safety-related requirements concerning its products, and any use of TI components in its applications, notwithstanding any applications-related information or support that may be provided by TI. Buyer represents and agrees that it has all the necessary expertise to create and implement safeguards which anticipate dangerous consequences of failures, monitor failures and their consequences, lessen the likelihood of failures that might cause harm and take appropriate remedial actions. Buyer will fully indemnify TI and its representatives against any damages arising out of the use of any TI components in safety-critical applications.

In some cases, TI components may be promoted specifically to facilitate safety-related applications. With such components, TI's goal is to help enable customers to design and create their own end-product solutions that meet applicable functional safety standards and requirements. Nonetheless, such components are subject to these terms.

No TI components are authorized for use in FDA Class III (or similar life-critical medical equipment) unless authorized officers of the parties have executed a special agreement specifically governing such use.

Only those TI components which TI has specifically designated as military grade or "enhanced plastic" are designed and intended for use in military/aerospace applications or environments. Buyer acknowledges and agrees that any military or aerospace use of TI components which have **not** been so designated is solely at the Buyer's risk, and that Buyer is solely responsible for compliance with all legal and regulatory requirements in connection with such use.

TI has specifically designated certain components as meeting ISO/TS16949 requirements, mainly for automotive use. In any case of use of non-designated products, TI will not be responsible for any failure to meet ISO/TS16949.

Products

Audio	www.ti.com/audio
Amplifiers	amplifier.ti.com
Data Converters	dataconverter.ti.com
DLP® Products	www.dlp.com
DSP	dsp.ti.com
Clocks and Timers	www.ti.com/clocks
Interface	interface.ti.com
Logic	logic.ti.com
Power Mgmt	power.ti.com
Microcontrollers	microcontroller.ti.com
RFID	www.ti-rfid.com
OMAP Applications Processors	www.ti.com/omap
Wireless Connectivity	www.ti.com/wirelessconnectivity

Applications

Automotive and Transportation	www.ti.com/automotive
Communications and Telecom	www.ti.com/communications
Computers and Peripherals	www.ti.com/computers
Consumer Electronics	www.ti.com/consumer-apps
Energy and Lighting	www.ti.com/energy
Industrial	www.ti.com/industrial
Medical	www.ti.com/medical
Security	www.ti.com/security
Space, Avionics and Defense	www.ti.com/space-avionics-defense
Video and Imaging	www.ti.com/video

TI E2E Community

e2e.ti.com