

Agilent ATF-511P8 High Linearity Enhancement Mode^[1] Pseudomorphic HEMT in 2x2 mm² LPCC^[3] Package

Data Sheet

Description

Agilent Technologies's ATF-511P8 is a single-voltage high linearity, low noise E-pHEMT housed in an 8-lead JEDEC-standard leadless plastic chip carrier (LPCC^[3]) package. The device is ideal as a high linearity, low-noise, medium-power amplifier. Its operating frequency range is from 50 MHz to 6 GHz.

The thermally efficient package measures only 2 mm x 2 mm x 0.75 mm. Its backside metalization provides excellent thermal dissipation as well as visual evidence of solder reflow. The device has a Point MTTF of over 300 years at a mounting temperature of +85°C. All devices are 100% RF & DC tested.

Note:

1. Enhancement mode technology employs a single positive V_{gs} , eliminating the need of negative gate voltage associated with conventional depletion mode devices.
2. Refer to reliability datasheet for detailed MTTF data.
3. Conforms to JEDEC reference outline M0229 for DRP-N.
4. Linearity Figure of Merit (LFOM) is essentially OIP3 divided by DC bias power.

Pin Connections and Package Marking

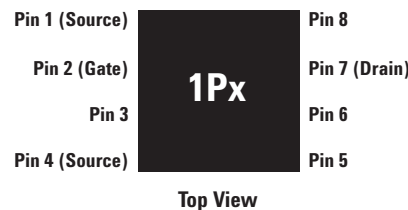
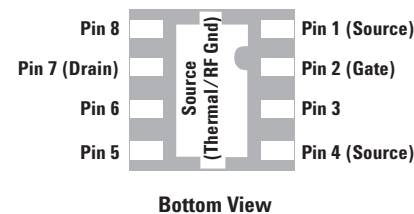

Note:

Package marking provides orientation and identification:

"1P" = Device Code

"x" = Date code indicates the month of manufacture.

Features

- Single voltage operation
- High linearity and P1dB
- Low noise figure
- Excellent uniformity in product specifications
- Small package size: 2.0 x 2.0 x 0.75 mm
- Point MTTF > 300 years^[2]
- MSL-1 and lead-free
- Tape-and-reel packaging option available

Specifications

2 GHz; 4.5V, 200 mA (Typ.)

- 41.7 dBm output IP3
- 30 dBm output power at 1 dB gain compression
- 1.4 dB noise figure
- 14.8 dB gain
- 12.1 dB LFOM^[4]
- 69% PAE

Applications

- Front-end LNA Q2 and Q3 driver or pre-driver amplifier for Cellular/PCS and WCDMA wireless infrastructure
- Driver amplifier for WLAN, WLL/RLL and MMDS applications
- General purpose discrete E-pHEMT for other high linearity applications



Agilent Technologies

ATF-511P8 Absolute Maximum Ratings^[1]

Symbol	Parameter	Units	Absolute Maximum
V_{DS}	Drain-Source Voltage ^[2]	V	7
V_{GS}	Gate-Source Voltage ^[2]	V	-5 to 1
V_{GD}	Gate Drain Voltage ^[2]	V	-5 to 1
I_{DS}	Drain Current ^[2]	A	1
I_{GS}	Gate Current	mA	46
P_{diss}	Total Power Dissipation ^[3]	W	3
$P_{in\ max.}$	RF Input Power ^[4]	dBm	+30
T_{CH}	Channel Temperature	°C	150
T_{STG}	Storage Temperature	°C	-65 to 150
θ_{ch_b}	Thermal Resistance ^[5]	°C/W	33

Notes:

1. Operation of this device in excess of any one of these parameters may cause permanent damage.
2. Assumes DC quiescent conditions.
3. Board (package belly) temperature T_B is 25°C. Derate 30 mW/°C for $T_B > 50^\circ\text{C}$.
4. With 10 Ohm series resistor in gate supply and 3:1 VSWR.
5. Channel-to-board thermal resistance measured using 150°C Liquid Crystal Measurement method.
6. Device can safely handle +30dBm RF Input Power provided I_{GS} limited to 46mA. I_{GS} at P_{1dB} drive level is bias circuit dependent.

Product Consistency Distribution Charts at 2 GHz, 4.5V, 200 mA^[6,7]

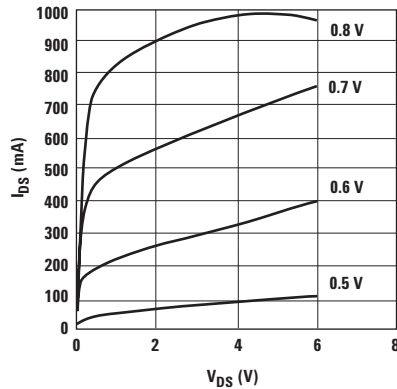

Figure 1. Typical I-V Curves
($V_{GS} = 0.1$ per step).

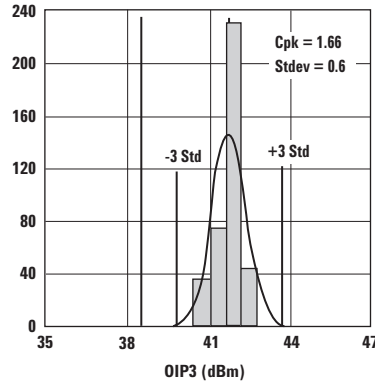

Figure 2. OIP3
LSL = 38.5, Nominal = 41.7.

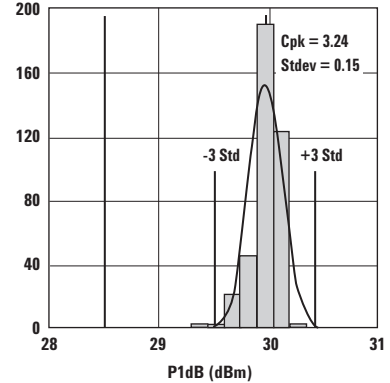

Figure 3. P1dB
LSL = 28.5, Nominal = 30.

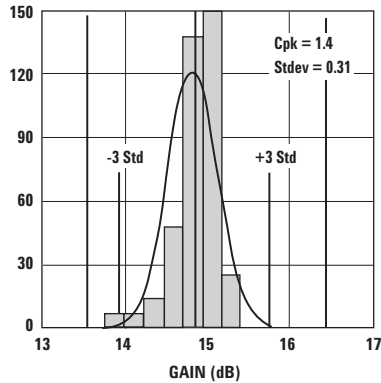

Figure 4. Gain
LSL = 13.5, Nominal = 14.8, USL = 16.5.

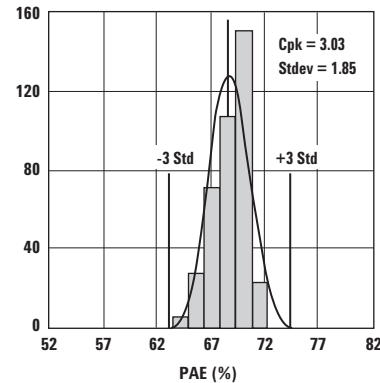

Figure 5. PAE
LSL = 52, Nominal = 68.9.

Notes:

6. Distribution data sample size is 400 samples taken from 4 different wafers and 3 different lots. Future wafers allocated to this product may have nominal values anywhere between the upper and lower limits.
7. Measurements are made on production test board, which represents a trade-off between optimal OIP3, P1dB and VSWR. Circuit losses have been de-embedded from actual measurements.

ATF-511P8 Electrical Specifications

$T_A = 25^\circ\text{C}$, DC bias for RF parameters is $V_{ds} = 4.5\text{V}$ and $I_{ds} = 200\text{ mA}$ unless otherwise specified.

Symbol	Parameter and Test Condition	Units	Min.	Typ.	Max.	
V_{gs}	Operational Gate Voltage	$V_{ds} = 4.5\text{V}, I_{ds} = 200\text{ mA}$	V	0.25	0.51	0.8
V_{th}	Threshold Voltage	$V_{ds} = 4.5\text{V}, I_{ds} = 32\text{ mA}$	V	—	0.28	—
I_{dss}	Saturated Drain Current	$V_{ds} = 4.5\text{V}, V_{gs} = 0\text{V}$	μA	—	16.4	—
G_m	Transconductance	$V_{ds} = 4.5\text{V}, G_m = \Delta I_{dss} / \Delta V_{gs};$ $\Delta V_{gs} = V_{gs1} - V_{gs2}$ $V_{gs1} = 0.55\text{V}, V_{gs2} = 0.5\text{V}$	mmho	—	2178	—
I_{gss}	Gate Leakage Current	$V_{ds} = 0\text{V}, V_{gs} = -4.5\text{V}$	μA	-27	-2	—
NF	Noise Figure ^[1]	$f = 2\text{ GHz}$	dB	—	1.4	—
		$f = 900\text{ MHz}$	dB	—	1.2	—
G	Gain ^[1]	$f = 2\text{ GHz}$	dB	13.5	14.8	16.5
		$f = 900\text{ MHz}$	dB	—	17.8	—
OIP3	Output 3 rd Order Intercept Point ^[1,2]	$f = 2\text{ GHz}$	dBm	38.5	41.7	—
		$f = 900\text{ MHz}$	dBm	—	43	—
P1dB	Output 1dB Compressed ^[1]	$f = 2\text{ GHz}$	dBm	28.5	30	—
		$f = 900\text{ MHz}$	dBm	—	29.6	—
PAE	Power Added Efficiency	$f = 2\text{ GHz}$	%	52	68.9	—
		$f = 900\text{ MHz}$	%	—	68.6	—
ACLR	Adjacent Channel Leakage Power Ratio ^[1,3]	Offset BW = 5 MHz	dBc	—	-58.9	—
		Offset BW = 10 MHz	dBc	—	-62.7	—

Notes:

- Measurements obtained using production test board described in Figure 6 and PAE tested at P1dB condition.
- I) 2 GHz OIP3 test condition: $F1 = 2.0\text{ GHz}, F2 = 2.01\text{ GHz}$ and $\text{Pin} = -5\text{ dBm}$ per tone.
II) 900 MHz OIP3 test condition: $F1 = 900\text{ MHz}, F2 = 910\text{ MHz}$ and $\text{Pin} = -5\text{ dBm}$ per tone.
- ACLR test spec is based on 3GPP TS 25.141 V5.3.1 (2002-06)
 - Test Model 1
 - Active Channels: PCCPCH + SCH + CPICH + PICH + SCCPCH + 64 DPCH (SF=128)
 - Freq = 2140 MHz
 - Pin = -5 dBm
 - Channel Integrate Bandwidth = 3.84 MHz
- Use proper bias, board, heatsink and derating designs to ensure maximum channel temperature is not exceeded. See absolute maximum ratings and application note for more details.

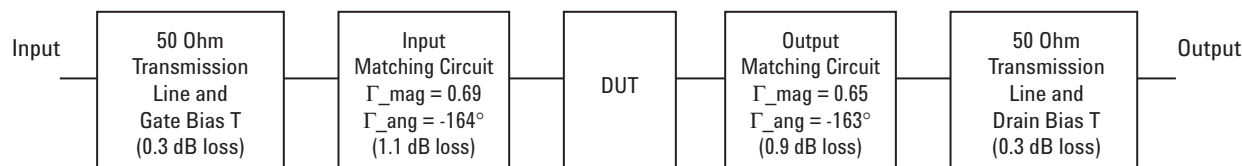

Figure 6. Block diagram of the 2 GHz production test board used for NF, Gain, OIP3, P1dB and PAE and ACLR measurements. This circuit achieves a trade-off between optimal OIP3, P1dB and VSWR. Circuit losses have been de-embedded from actual measurements.

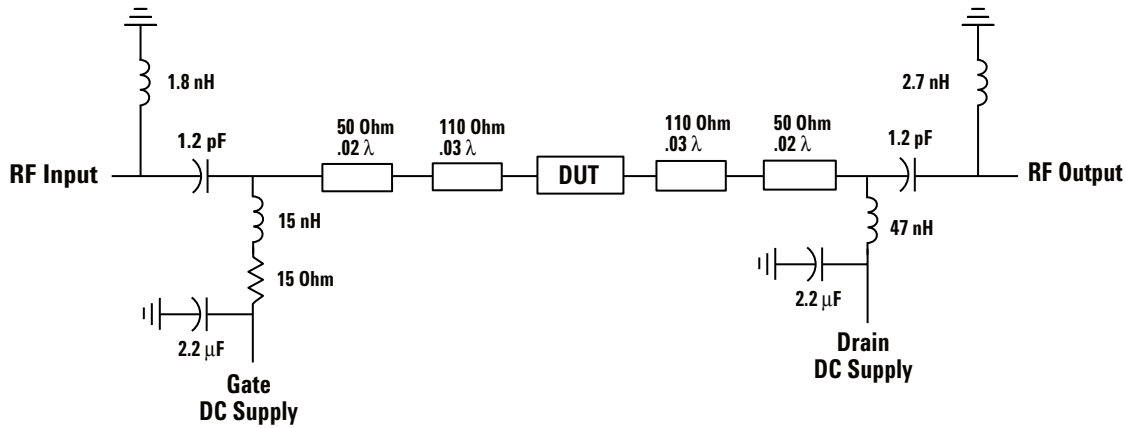

Figure 7. Simplified schematic of production test board. Primary purpose is to show 15 Ohm series resistor placement in gate supply. Transmission line tapers, tee intersections, bias lines and parasitic values are not shown.

Gamma Load and Source at Optimum OIP3 and P1dB Tuning Conditions

The device's optimum OIP3 and P1dB measurements were determined using a load pull system at 4.5V, 200 mA quiescent bias:

Optimum OIP3

Freq (GHz)	Gamma Source		Gamma Load		OIP3 (dBm)	Gain (dB)	P1dB (dBm)	PAE (%)
	Mag	Ang	Mag	Ang				
0.9	0.776	152	0.549	-178	43.3	17.94	29.63	63.8
2.0	0.872	-171	0.683	-179	43.1	15.06	30.12	66.8
2.4	0.893	-162	0.715	-174	42.8	14.03	29.90	64.5
3.9	0.765	-132	0.574	-144	41.7	9.47	29.02	52

Optimum P1dB

Freq (GHz)	Gamma Source		Gamma Load		OIP3 (dBm)	Gain (dB)	P1dB (dBm)	PAE (%)
	Mag	Ang	Mag	Ang				
0.9	0.773	153	0.784	-173	38.0	19.28	31.9	54.23
2.0	0.691	147	0.841	-166	36.4	10.34	31.4	38.15
2.4	0.797	164	0.827	-166	36.2	8.43	31.2	37.38
3.9	0.602	-163	0.794	-155	35.4	7.03	31	32.72

ATF-511P8 Typical Performance Curves (at 25°C unless specified otherwise)
Tuned for Optimal OIP3 at 4.5V 200 mA

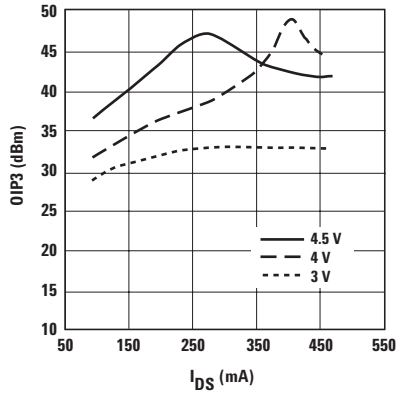

Figure 8. OIP3 vs. I_{DS} and V_{DS} at 2 GHz.

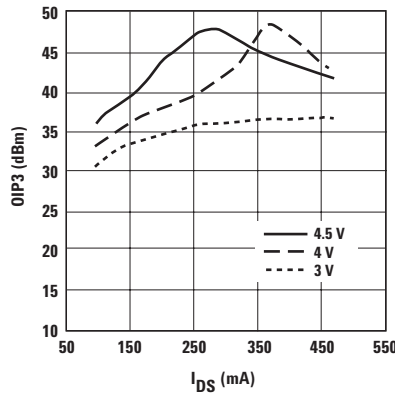

Figure 9. OIP3 vs. I_{DS} and V_{DS} at 900 MHz.

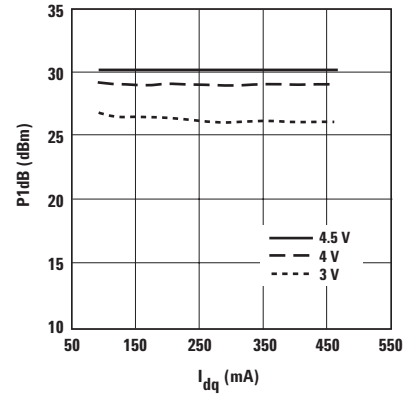

Figure 10. P1dB vs. I_{dq} and V_{DS} at 2 GHz.

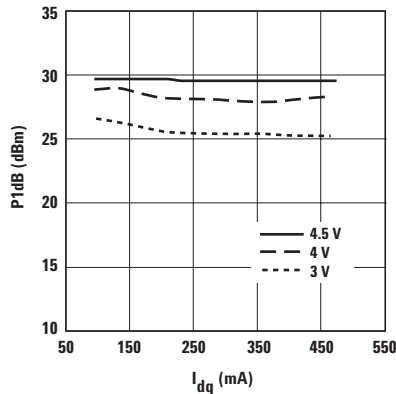

Figure 11. P1dB vs. I_{dq} and V_{DS} at 900 MHz.

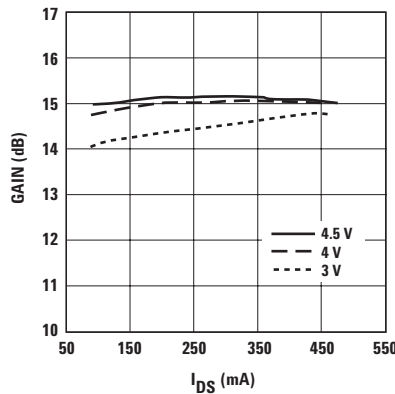

Figure 12. Gain vs. I_{DS} and V_{DS} at 2 GHz.

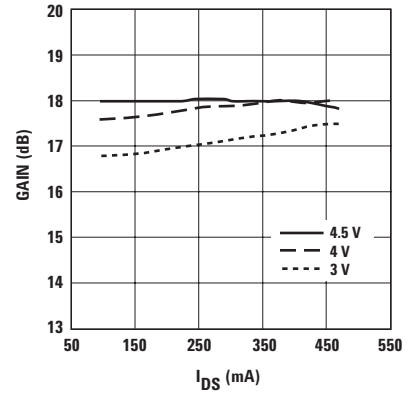

Figure 13. Gain vs. I_{DS} and V_{DS} at 900 MHz.

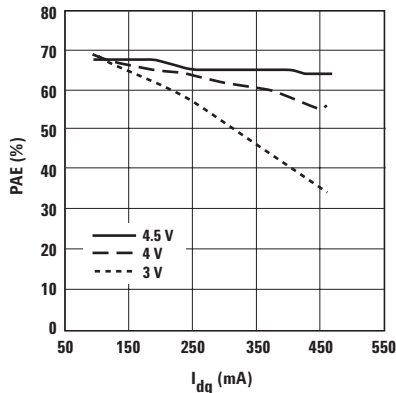

Figure 14. PAE vs. I_{dq} and V_{DS} at 2 GHz.

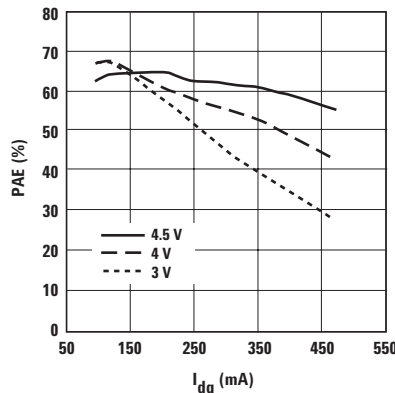

Figure 15. PAE vs. I_{dq} and V_{DS} at 900 MHz.

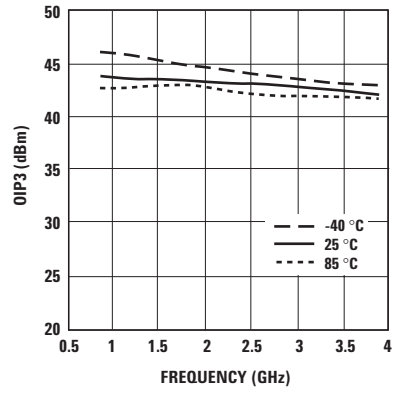

Figure 16. OIP3 vs. Temp and Freq.

Note:

Bias current for the above charts are quiescent conditions. Actual level may increase or decrease depending on amount of RF drive.

ATF-511P8 Typical Performance Curves, continued (at 25°C unless specified otherwise)
Tuned for Optimal OIP3 at 4.5V, 200 mA

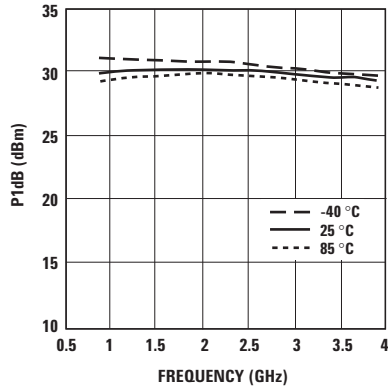

Figure 17. P1dB vs. Temp and Freq.

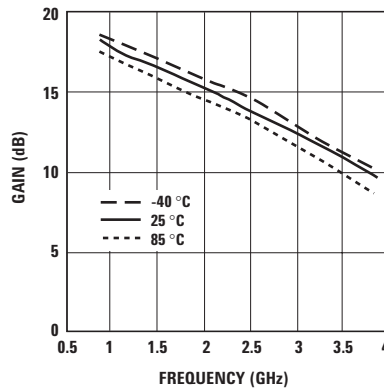

Figure 18. Gain vs. Temp and Freq.

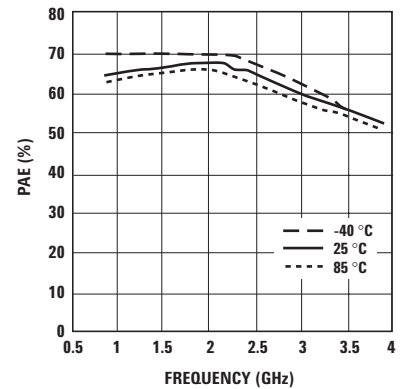

Figure 19. PAE vs. Temp and Freq.

ATF-511P8 Typical Performance Curves (at 25°C unless specified otherwise)
Tuned for Optimal P1dB at 4.5 V, 200 mA

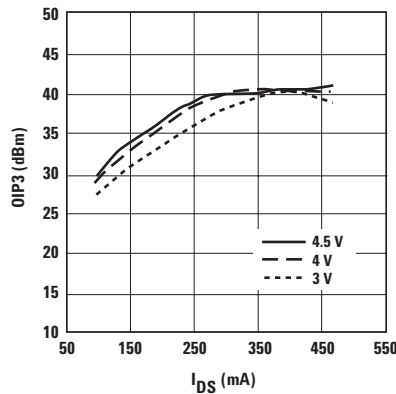

Figure 20. OIP3 vs. I_{DS} and V_{DS} at 2 GHz.

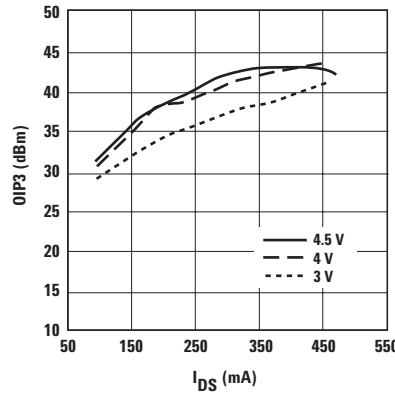

Figure 21. OIP3 vs. I_{DS} and V_{DS} at 900 MHz.

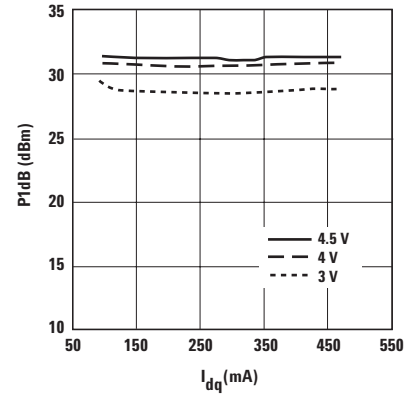

Figure 22. P1dB vs. I_{dq} and V_{DS} at 2 GHz.

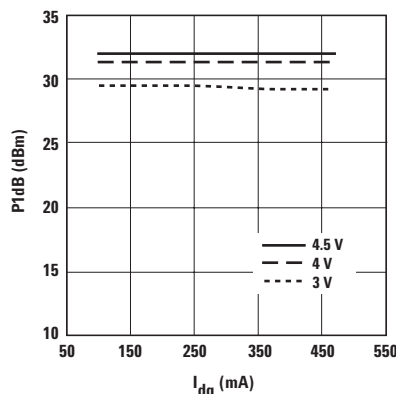

Figure 23. P1dB vs. I_{dq} and V_{DS} at 900 MHz.

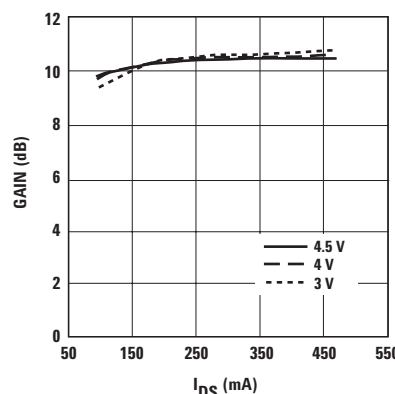

Figure 24. Gain vs. I_{DS} and V_{DS} at 2 GHz.

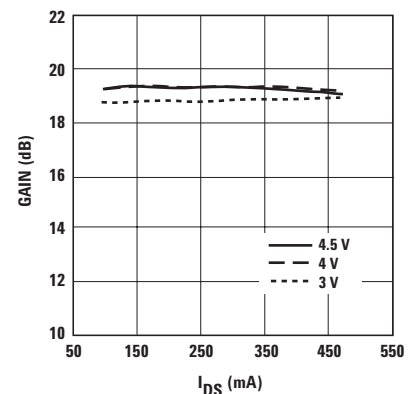

Figure 25. Gain vs. I_{DS} and V_{DS} at 900 MHz.

Note:

Bias current for the above charts are quiescent conditions. Actual level may increase or decrease depending on amount of RF drive.

**ATF-511P8 Typical Performance Curves, continued (at 25°C unless specified otherwise)
Tuned for Optimal P1dB at 4.5V, 200 mA**

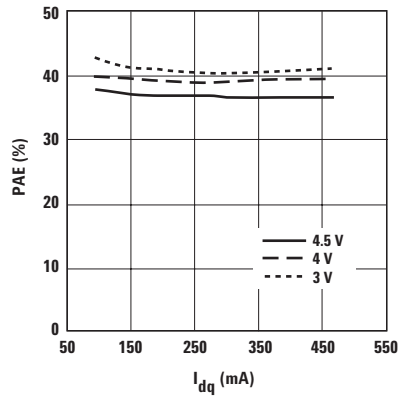

Figure 26. PAE vs. I_{dq} and V_{DS} at 2 GHz.

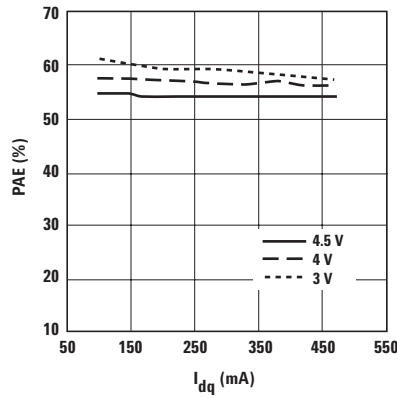

Figure 27. PAE vs. I_{dq} and V_{DS} at 900 MHz.

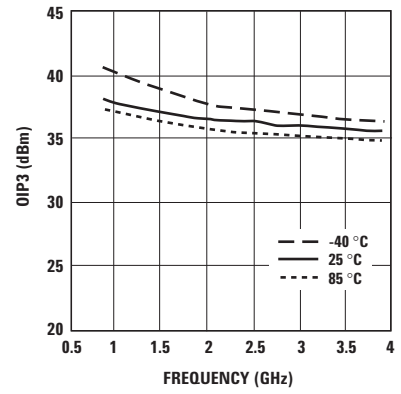

Figure 28. OIP3 vs. Temp and Freq.

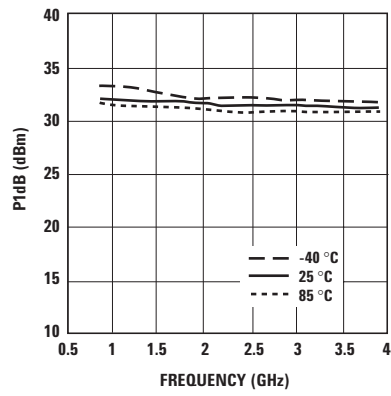

Figure 29. P1dB vs. Temp and Freq.

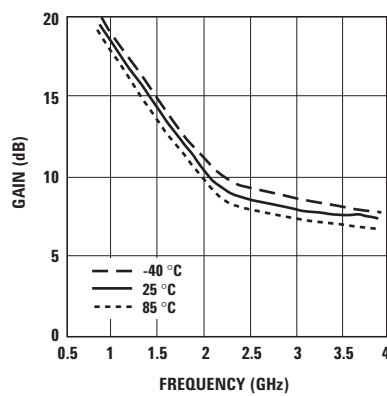

Figure 30. Gain vs. Temp and Freq.

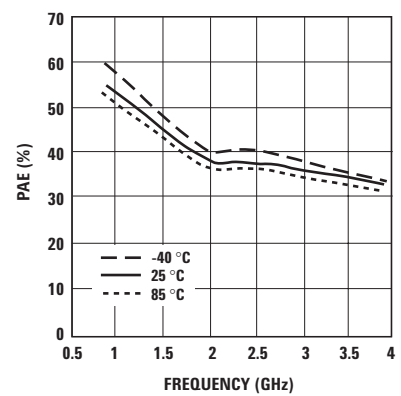

Figure 31. PAE vs. Temp and Freq.

Note:

Bias current for the above charts are quiescent conditions. Actual level may increase or decrease depending on amount of RF drive.

ATF-511P8 Typical Scattering Parameters, $V_{DS} = 4.5V$, $I_{DS} = 300\text{ mA}$

Freq. GHz	S_{11}			S_{21}			S_{12}		S_{22}		MSG/MAG dB
	Mag.	Ang.	dB	Mag.	Ang.	dB	Mag.	Ang.	Mag.	Ang.	
0.1	0.94	-134.9	31.16	36.15	111.2	-38.53	0.01	29.7	0.73	-164.5	34.79
0.2	0.93	-157.7	25.64	19.14	99.2	-37.87	0.01	21.8	0.76	-173.7	31.68
0.3	0.93	-166.6	22.26	12.97	94.2	-37.61	0.01	21.1	0.78	-176.8	29.99
0.4	0.93	-171.8	19.78	9.74	90.9	-37.09	0.01	23.4	0.78	-179.9	28.43
0.5	0.92	-173.9	18.70	8.60	88.9	-36.15	0.01	25.4	0.75	-178.9	27.31
0.6	0.93	-176.9	17.12	7.18	86.1	-35.80	0.01	27.0	0.75	-176.9	26.52
0.7	0.92	-178.8	15.78	6.15	84.3	-35.41	0.01	29.5	0.75	-175.5	25.59
0.8	0.93	178.7	14.61	5.37	82.3	-35.11	0.01	32.5	0.76	-174.0	24.75
0.9	0.92	177.1	13.58	4.77	80.6	-35.00	0.01	33.1	0.75	-172.8	24.24
1	0.93	175.7	12.64	4.28	79.1	-34.46	0.01	35.0	0.76	-171.6	23.53
1.5	0.93	168.7	8.99	2.81	71.4	-32.70	0.02	40.0	0.76	-166.0	20.88
2	0.93	163.0	6.36	2.08	64.2	-31.27	0.02	42.3	0.76	-160.6	17.20
2.5	0.92	157.8	4.40	1.66	57.2	-29.90	0.03	42.5	0.76	-155.5	14.71
3	0.92	152.5	2.73	1.36	50.4	-28.59	0.03	41.6	0.75	-149.7	12.65
4	0.92	142.8	0.03	1.00	37.6	-26.69	0.04	35.7	0.74	-138.6	9.96
5	0.91	133.2	-2.17	0.77	24.2	-25.30	0.05	29.8	0.71	-127.2	7.23
6	0.91	124.6	-4.21	0.61	14.1	-24.32	0.06	23.7	0.65	-117.2	4.97
7	0.91	115.7	-5.80	0.51	5.6	-23.48	0.06	19.5	0.59	-111.3	3.02
8	0.91	106.0	-6.82	0.45	-2.6	-22.49	0.07	14.1	0.56	-108.2	1.86
9	0.91	95.5	-7.36	0.42	-10.2	-21.39	0.08	8.5	0.58	-103.7	1.19
10	0.90	85.2	-7.98	0.40	-22.2	-20.50	0.09	0.4	0.60	-96.0	0.53
11	0.89	74.3	-8.69	0.38	-29.1	-19.72	0.10	-8.4	0.63	-87.2	-0.04
12	0.89	63.0	-9.25	0.35	-40.1	-19.42	0.10	-17.1	0.65	-77.6	-0.61
13	0.89	54.1	-9.80	0.32	-51.7	-19.12	0.11	-23.9	0.67	-68.2	-1.04
14	0.90	46.3	-10.25	0.31	-55.2	-18.65	0.11	-29.7	0.69	-58.7	-1.13
15	0.90	40.6	-10.86	0.30	-57.3	-18.57	0.11	-35.8	0.69	-50.1	-1.88
16	0.89	33.3	-11.16	0.32	-71.1	-18.02	0.12	-42.3	0.71	-41.8	-2.26
17	0.83	25.4	-11.81	0.24	-75.3	-17.65	0.13	-47.1	0.73	-35.1	-3.17
18	0.86	20.0	-12.07	0.24	-90.5	-17.43	0.13	-53.1	0.76	-27.7	-3.76

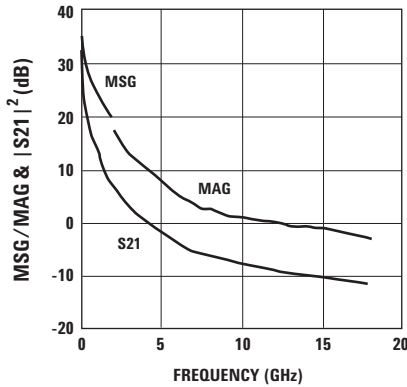

Figure 32. MSG/MAG & $|S_{21}|^2$ (dB)
@ 4.5V, 300 mA.

Notes:

1. S parameter is measured on a microstrip line made on 0.025 inch thick alumina carrier. The input reference plane is at the end of the gate lead. The output reference plane is at the end of the drain lead.

ATF-511P8 Typical Scattering Parameters, $V_{DS} = 4.5V$, $I_{DS} = 200\text{ mA}$

Freq. GHz	S_{11}			S_{21}			S_{12}		S_{22}		MSG/MAG dB
	Mag.	Ang.	dB	Mag.	Ang.	dB	Mag.	Ang.	Mag.	Ang.	
0.1	0.94	-132.6	31.26	36.54	112.1	-37.40	0.01	27.2	0.70	-161.0	34.49
0.2	0.93	-156.3	25.79	19.47	99.6	-36.68	0.01	19.2	0.74	-171.6	31.13
0.3	0.94	-165.6	22.40	13.18	94.4	-36.47	0.01	19.9	0.76	-175.6	29.44
0.4	0.93	-170.8	19.93	9.92	91.1	-36.17	0.01	19.9	0.76	-178.8	27.93
0.5	0.92	-173.1	18.84	8.75	89.0	-35.11	0.01	24.6	0.73	-179.9	26.87
0.6	0.92	-176.2	17.26	7.29	86.2	-34.84	0.01	23.9	0.73	-177.8	26.08
0.7	0.92	-178.2	15.92	6.25	84.3	-34.72	0.01	25.6	0.73	-176.2	25.41
0.8	0.92	179.4	14.76	5.47	82.3	-34.37	0.01	27.6	0.74	-174.7	24.59
0.9	0.93	177.4	13.72	4.85	80.4	-34.02	0.02	28.6	0.74	-173.4	23.85
1	0.92	176.0	12.77	4.34	79.1	-33.71	0.02	30.8	0.74	-172.2	23.16
1.5	0.93	168.9	9.13	2.86	70.9	-32.20	0.02	35.0	0.74	-166.5	20.59
2	0.93	163.6	6.49	2.11	63.7	-30.97	0.02	38.2	0.74	-161.1	17.50
2.5	0.92	157.9	4.50	1.67	56.8	-29.65	0.03	39.1	0.74	-155.9	14.78
3	0.93	152.6	2.81	1.38	49.3	-28.54	0.03	38.1	0.74	-150.2	13.16
4	0.91	143.1	0.16	1.01	35.8	-26.68	0.04	33.9	0.73	-139.0	9.84
5	0.91	133.7	-2.08	0.78	22.7	-25.40	0.05	28.0	0.70	-127.4	7.34
6	0.91	124.7	-4.02	0.62	12.0	-24.42	0.06	22.3	0.65	-117.0	5.01
7	0.90	115.7	-5.75	0.51	3.3	-23.61	0.06	18.2	0.58	-110.2	2.77
8	0.90	105.6	-6.77	0.45	-3.9	-22.73	0.07	14.4	0.54	-107.5	1.56
9	0.91	95.7	-7.45	0.42	-12.1	-21.60	0.08	8.4	0.55	-103.9	1.13
10	0.91	84.9	-7.95	0.40	-22.4	-20.76	0.09	0.9	0.58	-97.0	0.82
11	0.89	74.0	-8.29	0.38	-32.0	-19.93	0.10	-8.6	0.61	-88.4	-0.05
12	0.89	63.1	-9.19	0.34	-39.5	-19.45	0.10	-16.8	0.64	-78.9	-0.82
13	0.89	54.0	-9.74	0.326	-51.1	-19.03	0.11	-24.1	0.67	-69.1	-1.38
14	0.90	46.4	-10.17	0.31	-58.1	-18.78	0.11	-30.7	0.68	-59.6	-1.33
15	0.90	38.8	-10.85	0.28	-67.8	-18.47	0.11	-36.1	0.68	-50.9	-1.80
16	0.91	33.1	-10.77	0.28	-73.7	-18.19	0.12	-42.9	0.71	-42.0	-2.11
17	0.85	26.8	-11.05	0.28	-83.3	-17.88	0.12	-47.5	0.73	-35.3	-2.60
18	0.87	19.3	-11.53	0.26	-100.4	-17.54	0.13	-53.8	0.75	-27.3	-2.83

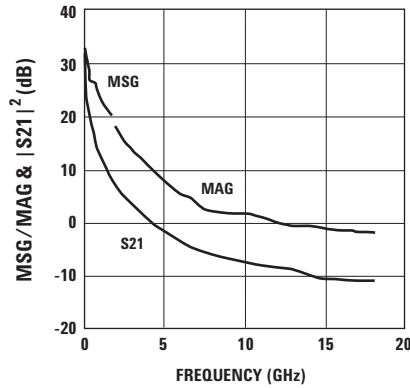

Notes:

1. S parameter is measured on a microstrip line made on 0.025 inch thick alumina carrier. The input reference plane is at the end of the gate lead. The output reference plane is at the end of the drain lead.

Figure 33. MSG/MAG & $|S_{21}|^2$ (dB)
@ 4.5V, 200 mA.

ATF-511P8 Typical Scattering Parameters, $V_{DS} = 4.5V$, $I_{DS} = 100\text{ mA}$

Freq. GHz	S_{11}			S_{21}			S_{12}		S_{22}		MSG/MAG dB
	Mag.	Ang.	dB	Mag.	Ang.	dB	Mag.	Ang.	Mag.	Ang.	
0.1	0.93	-125.4	30.99	35.43	115.3	-34.72	0.01	28.6	0.65	-151.1	32.94
0.2	0.93	-152.1	25.70	19.27	101.4	-33.88	0.02	18.9	0.70	-166.3	29.84
0.3	0.93	-162.8	22.34	13.09	95.5	-33.70	0.02	15.5	0.72	-172.2	27.95
0.4	0.92	-168.7	19.90	9.88	91.8	-33.49	0.02	16.5	0.72	-176.0	26.73
0.5	0.91	-170.8	18.78	8.68	89.5	-32.50	0.02	17.7	0.69	-177.2	25.59
0.6	0.91	-174.4	17.21	7.25	86.6	-32.42	0.02	17.6	0.7	-179.7	24.80
0.7	0.92	-176.8	15.88	6.22	84.4	-32.20	0.02	19.1	0.7	178.3	23.96
0.8	0.92	-179.0	14.72	5.44	82.3	-32.13	0.02	18.8	0.70	176.6	23.38
0.9	0.92	178.7	13.69	4.83	80.4	-32.02	0.02	18.9	0.70	175.2	22.86
1	0.91	177.0	12.73	4.33	78.8	-31.85	0.02	20.6	0.70	173.8	22.22
1.5	0.92	169.8	9.11	2.85	70.2	-30.95	0.02	24.8	0.70	167.8	20.08
2	0.91	163.9	6.49	2.11	62.8	-30.00	0.03	27.8	0.71	162.3	18.19
2.5	0.91	158.8	4.52	1.68	55.2	-29.22	0.03	29.0	0.71	157.2	14.84
3	0.91	153.0	2.89	1.39	47.7	-28.39	0.03	29.0	0.71	151.6	12.76
4	0.91	143.7	0.20	1.02	33.1	-26.77	0.04	27.2	0.70	140.4	9.92
5	0.91	134.0	-2.08	0.78	19.2	-25.62	0.05	22.2	0.68	128.7	7.42
6	0.90	125.0	-4.20	0.61	7.3	-24.73	0.05	17.3	0.64	117.4	4.79
7	0.90	115.7	-6.04	0.49	-1.6	-23.99	0.06	14.3	0.56	109.1	2.45
8	0.90	106.4	-7.35	0.42	-7.7	-23.23	0.06	11.2	0.51	106.4	0.71
9	0.90	96.5	-8.14	0.39	-16.4	-22.04	0.07	7.2	0.51	105.0	0.01
10	0.9	86.1	-8.45	0.37	-25.3	-20.89	0.09	0.5	0.54	99.3	-0.37
11	0.89	75.4	-9.46	0.33	-35.2	-20.08	0.09	-7.5	0.58	90.9	-1.33
12	0.90	63.8	-9.59	0.33	-46.1	-19.41	0.10	-16.7	0.62	81.3	-1.60
13	0.89	54.7	-10.42	0.30	-52.9	-19.02	0.11	-25.1	0.65	71.3	-1.93
14	0.90	46.5	-10.99	0.28	-59.8	-18.87	0.11	-31.7	0.67	61.4	-2.12
15	0.88	40.2	-11.15	0.27	-70.6	-18.71	0.11	-38.2	0.68	52.4	-2.66
16	0.90	33.5	-11.50	0.26	-71.7	-18.22	0.12	-45.5	0.70	43.3	-2.83
17	0.86	26.4	-11.50	0.26	-80.8	-18.28	0.12	-49.0	0.72	35.9	-3.33
18	0.86	19.3	-11.51	0.26	-92.6	-17.88	0.12	-54.8	0.74	27.9	-3.69

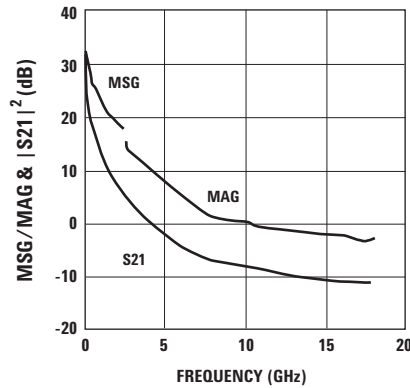

Notes:

1. S parameter is measured on a microstrip line made on 0.025 inch thick alumina carrier. The input reference plane is at the end of the gate lead. The output reference plane is at the end of the drain lead.

Figure 34. MSG/MAG & $|S_{21}|^2$ (dB)
@ 4.5V, 100 mA.

ATF-511P8 Typical Scattering Parameters, $V_{DS} = 4V$, $I_{DS} = 200\text{ mA}$

Freq. GHz	S_{11}			S_{21}			S_{12}		S_{22}		MSG/MAG dB
	Mag.	Ang.	dB	Mag.	Ang.	dB	Mag.	Ang.	Mag.	Ang.	
0.1	0.94	-133.7	30.85	34.87	111.4	-37.28	0.01	28.2	0.73	-162.5	33.96
0.2	0.93	-156.9	25.31	18.41	99.5	-36.61	0.01	20.4	0.76	-172.6	30.89
0.3	0.93	-165.9	21.89	12.43	94.2	-36.19	0.01	20.2	0.78	-176.3	28.90
0.4	0.94	-170.9	19.48	9.42	90.9	-35.98	0.01	20.4	0.78	-179.5	27.70
0.5	0.93	-174.5	17.53	7.52	88.8	-35.84	0.01	23.0	0.78	-178.5	26.73
0.6	0.93	-175.8	16.77	6.89	86.0	-34.69	0.01	23.5	0.76	-177.3	25.83
0.7	0.93	-178.2	15.53	5.97	84.2	-34.42	0.01	25.0	0.75	-175.5	24.98
0.8	0.92	-179.7	14.28	5.17	82.5	-34.11	0.02	27.1	0.76	-173.9	24.13
0.9	0.92	-178.0	13.21	4.57	80.5	-33.77	0.02	29.2	0.76	-172.5	23.60
1	0.93	-176.3	12.34	4.13	78.6	-33.66	0.02	29.6	0.76	-171.4	22.95
1.5	0.92	-169.6	8.63	2.70	71.0	-32.21	0.02	34.5	0.76	-165.3	20.34
2	0.93	-164.4	6.12	2.02	63.5	-30.69	0.02	38.0	0.76	-159.2	17.32
2.5	0.92	-159.6	4.07	1.59	57.0	-29.46	0.03	39.4	0.76	-154.1	14.52
3	0.92	-154.2	2.30	1.30	50.3	-28.47	0.03	37.7	0.75	-148.6	12.34
4	0.92	-144.9	-0.31	0.96	37.4	-26.48	0.04	33.8	0.73	-137.1	9.75
5	0.91	-135.5	-2.55	0.74	25.4	-25.14	0.05	28.4	0.69	-127.3	6.74
6	0.92	-126.6	-4.30	0.60	15.1	-24.15	0.06	23.4	0.64	-119.4	5.17
7	0.91	-117.1	-5.64	0.52	6.50	-23.20	0.06	18.3	0.62	-114.5	3.27
8	0.91	-108.2	-6.81	0.45	-2.8	-22.06	0.07	12.3	0.62	-108.5	2.03
9	0.90	-99.1	-7.13	0.44	-13.7	-21.10	0.08	5.2	0.62	-100.8	1.60
10	0.92	-89.2	-7.76	0.40	-21.2	-20.40	0.09	-2.7	0.64	-90.4	1.40
11	0.90	-79.6	-8.39	0.38	-30.0	-19.67	0.10	-11.0	0.65	-79.3	0.26
12	0.91	-70.9	-8.92	0.35	-42.9	-19.28	0.10	-19.9	0.66	-67.0	0.15
13	0.90	-62.2	-9.42	0.33	-48.9	-19.11	0.11	-27.2	0.67	-57.1	-0.69
14	0.94	-53.8	-9.84	0.32	-60.1	-18.86	0.11	-33.1	0.68	-48.7	-1.20
15	0.87	-45.0	-10.51	0.29	-68.5	-18.58	0.11	-38.4	0.7	-40.0	-1.56
16	0.89	-37.7	-10.74	0.29	-72.4	-18.59	0.11	-43.7	0.71	-36.3	-1.97
17	0.89	-30.5	-10.03	0.31	-85.1	-17.88	0.12	-48.3	0.73	-28.8	-2.50
18	0.88	-25.4	-11.77	0.25	-91.8	-17.72	0.13	-59.0	0.74	-19.5	-2.82

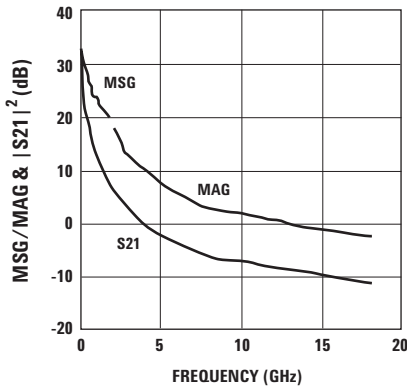

Notes:

1. S parameter is measured on a microstrip line made on 0.025 inch thick alumina carrier. The input reference plane is at the end of the gate lead. The output reference plane is at the end of the drain lead.

Figure 35. MSG/MAG & $|S_{21}|^2$ (dB)
@ 4V, 200 mA.

ATF-511P8 Typical Scattering Parameters, $V_{DS} = 3V$, $I_{DS} = 200\text{ mA}$

Freq. GHz	S_{11}			S_{21}			S_{12}		S_{22}		MSG/MAG dB
	Mag.	Ang.	dB	Mag.	Ang.	dB	Mag.	Ang.	Mag.	Ang.	
0.1	0.95	-137.1	29.51	29.89	109.9	-36.88	0.01	25.2	0.78	-166.0	33.29
0.2	0.94	-159.0	23.89	15.65	98.7	-36.27	0.01	19.8	0.81	-174.5	30.18
0.3	0.94	-167.3	20.46	10.54	93.8	-36.20	0.01	18.0	0.82	-177.6	28.47
0.4	0.94	-172.0	18.04	7.98	90.7	-35.82	0.01	20.5	0.83	-179.4	26.98
0.5	0.93	-175.3	16.10	6.38	88.7	-35.59	0.01	22.4	0.83	-177.6	25.75
0.6	0.93	-176.8	15.36	5.86	85.9	-34.34	0.01	24.0	0.81	-176.3	24.89
0.7	0.93	-178.7	14.14	5.09	84.2	-34.27	0.01	24.8	0.81	-174.6	24.28
0.8	0.93	179.1	12.87	4.4	82.6	-34.12	0.02	27.1	0.81	-173.1	23.42
0.9	0.93	177.3	11.82	3.89	80.6	-33.66	0.02	29.1	0.81	-171.7	22.69
1	0.93	176.1	10.91	3.51	78.9	-33.55	0.02	29.3	0.81	-170.7	22.23
1.5	0.93	169.4	7.24	2.30	71.8	-31.97	0.02	35.4	0.81	-164.6	19.64
2	0.93	164.0	4.75	1.72	64.7	-30.60	0.03	38.5	0.81	-158.5	16.34
2.5	0.93	159.1	2.73	1.36	58.5	-29.39	0.03	38.5	0.81	-153.4	14.08
3	0.92	154.0	0.93	1.11	51.6	-28.15	0.03	37.4	0.80	-147.6	11.72
4	0.93	144.8	-1.58	0.83	38.7	-26.26	0.04	33.1	0.78	-135.8	9.24
5	0.92	135.2	-3.78	0.64	27.3	-24.91	0.05	27.7	0.74	-125.0	6.28
6	0.93	126.0	-5.54	0.52	17.2	-24.05	0.06	22.1	0.68	-115.6	4.39
7	0.91	116.6	-7.07	0.44	10.5	-23.11	0.07	17.2	0.63	-110.7	1.96
8	0.91	107.4	-7.66	0.41	2.06	-22.08	0.07	12.1	0.62	-106.3	1.32
9	0.90	98.4	-8.06	0.39	-5.6	-21.04	0.08	5.0	0.63	-99.5	0.60
10	0.92	89.0	-8.99	0.35	-15.9	-20.23	0.09	-2.7	0.64	-89.8	0.49
11	0.92	79.5	-9.12	0.35	-25.8	-19.45	0.10	-12.4	0.66	-78.7	0.19
12	0.91	70.1	-9.28	0.34	-35.9	-19.08	0.11	-21.4	0.68	-66.3	-0.19
13	0.91	61.9	-9.71	0.32	-39.9	-18.93	0.11	-29.2	0.69	-56.4	-0.68
14	0.92	51.8	-10.04	0.31	-54.7	-18.89	0.11	-35.6	0.70	-47.9	-0.40
15	0.88	44.1	-10.01	0.31	-59.8	-18.63	0.11	-40.7	0.72	-39.0	-1.57
16	0.87	36.4	-10.16	0.31	-77.5	-18.83	0.11	-44.7	0.73	-35.3	-1.85
17	0.83	30.1	-10.61	0.31	-87.2	-18.17	0.12	-51.2	0.74	-27.7	-2.42
18	0.85	24.0	-11.96	0.25	-97.4	-17.69	0.13	-58.3	0.75	-18.3	-3.71

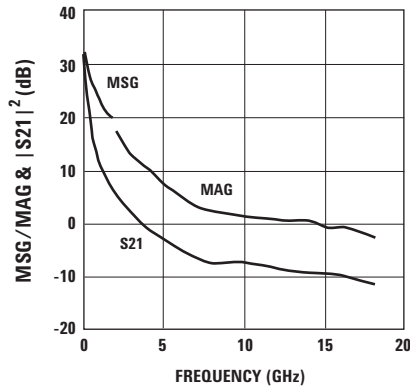

Figure 36. MSG/MAG & $|S_{21}|^2$ (dB)
@ 3V, 200 mA.

Notes:

1. S parameter is measured on a microstrip line made on 0.025 inch thick alumina carrier. The input reference plane is at the end of the gate lead. The output reference plane is at the end of the drain lead.

Device Models
Refer to Agilent's Web Site
www.agilent.com/view/rf

Ordering Information

Part Number	No. of Devices	Container
ATF-511P8-TR1	3000	7" Reel
ATF-511P8-TR2	10000	13" Reel
ATF-511P8-BLK	100	antistatic bag

2x2 LPCC (JEDEC DFP-N) Package Dimensions

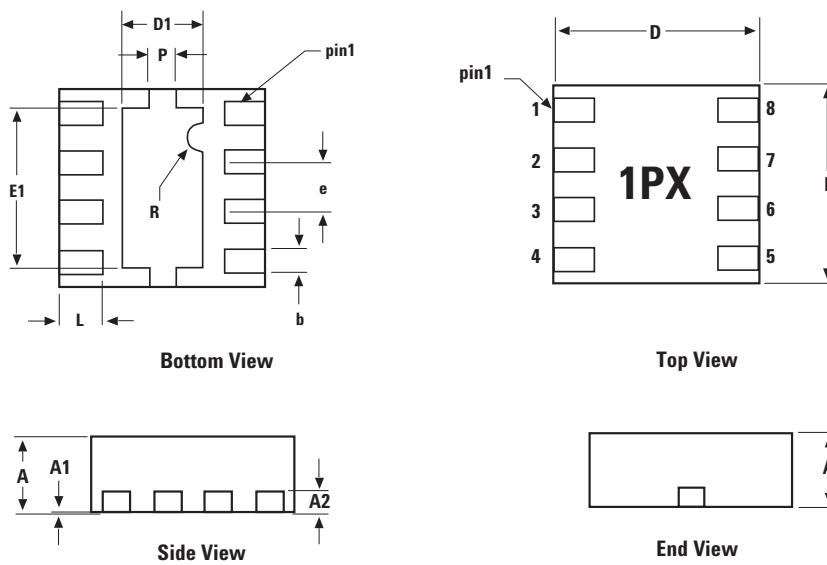

SYMBOL	DIMENSIONS		
	MIN.	NOM.	MAX.
A	0.70	0.75	0.80
A1	0	0.02	0.05
A2	0.203 REF	0.203 REF	0.203 REF
b	0.225	0.25	0.275
D	1.9	2.0	2.1
D1	0.65	0.80	0.95
E	1.9	2.0	2.1
E1	1.45	1.6	1.75
e	0.50 BSC	0.50 BSC	0.50 BSC
P	0.20	0.25	0.30
L	0.35	0.40	0.45

DIMENSIONS ARE IN MILLIMETERS

PCB Land Pattern and Stencil Design

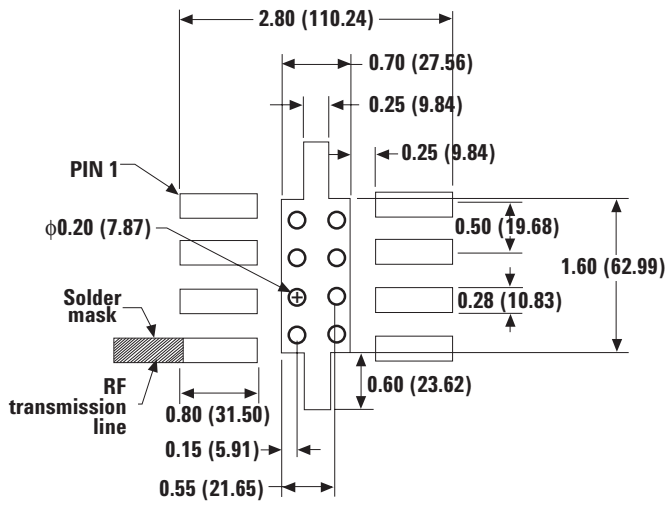

PCB Land Pattern (top view)

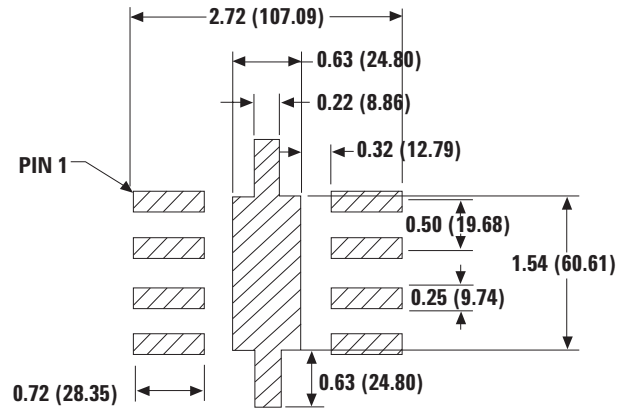

Stencil Layout (top view)

Notes:

Typical stencil thickness is 5 mils.
Measurements are in millimeters (mils).

Device Orientation

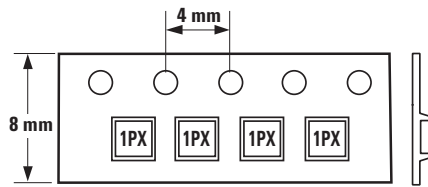
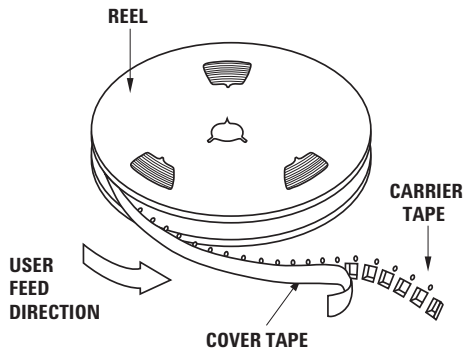

Tape Dimensions

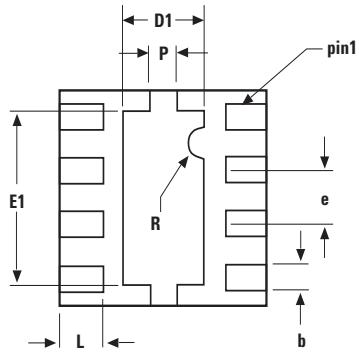

Bottom View

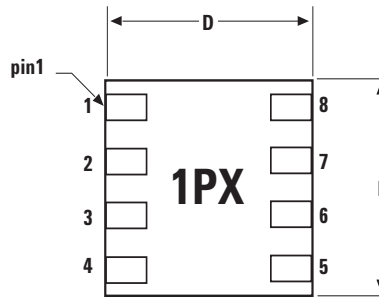

Top View

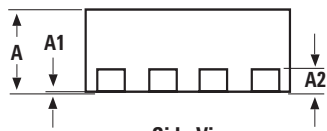

Side View

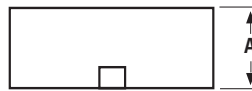

End View

SYMBOL	DIMENSIONS		
	MIN.	NOM.	MAX.
A	0.70	0.75	0.80
A1	0	0.02	0.05
A2	0.203 REF	0.203 REF	0.203 REF
b	0.225	0.25	0.275
D	1.9	2.0	2.1
D1	0.65	0.80	0.95
E	1.9	2.0	2.1
E1	1.45	1.6	1.75
e	0.50 BSC	0.50 BSC	0.50 BSC
P	0.20	0.25	0.30
L	0.35	0.40	0.45

DIMENSIONS ARE IN MILLIMETERS

www.agilent.com/semiconductors

For product information and a complete list of distributors, please go to our web site.

For technical assistance call:

Americas/Canada: +1 (800) 235-0312 or
(916) 788-6763

Europe: +49 (0) 6441 92460

China: 10800 650 0017

Hong Kong: (+65) 6271 2451

India, Australia, New Zealand: (+65) 6271 2394

Japan: (+81 3) 3335-8152(Domestic/International), or
0120-61-1280(Domestic Only)

Korea: (+65) 6271 2194

Malaysia, Singapore: (+65) 6271 2054

Taiwan: (+65) 6271 2654

Data subject to change.

Copyright © 2003 Agilent Technologies, Inc.

Obsoletes 5988-8246EN (12/02)

August 5, 2003

5989-0003EN



Agilent Technologies