

# HFBR-0508Z Series HFBR-1528Z Transmitter HFBR-2528Z Receiver

10 Megabaud Versatile Link Fiber Optic Transmitter  
and Receiver for 1 mm POF and 200  $\mu\text{m}$  HCS®

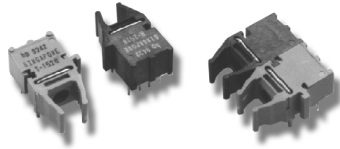

## Data Sheet



### Description

The HFBR-0508Z Series consists of a fiber-optic transmitter and receiver operating at a 650 nm wavelength (red). The HFBR-1528Z transmitter is an LED in a low cost plastic housing designed to efficiently couple power into 200  $\mu\text{m}$  diameter HCS and 1 mm diameter POF. The HFBR-2528Z receiver incorporates a PIN detector and digital output IC compatible with CMOS and TTL logic families.

HFBR-0508Z links operate from DC to 10 MBd at distances up to 50 meters with 1 mm POF and up to 500 meters with 200  $\mu\text{m}$  HCS®.

No minimum link distances are required when using recommended circuits, simplifying design.

Versatile Link components can be interlocked (N-plexed together) to minimize space and to provide dual connections with the duplex connectors. Up to eight packages can be interlocked and inserted into a printed circuit board.

POF and HCS are available in pre-connected lengths or can be easily field-terminated. A single transmitter drive current for POF and HCS allows both fibers to be used with a single design.

### Features

- RoHS-compliant
- Data transmission at signal rates of dc to 10 MBd
- Up to 50 meters distances with 1 mm Plastic Optical Fiber (POF)
- Up to 500 meters distances with 200  $\mu\text{m}$  Hard Clad Silica (HCS®)
- Wide dynamic range receiver allows operation from zero to maximum link distance with a single transmitter drive current
- Link distances specified for variations in temperature, power supply, and fiber attenuation
- DC coupled receiver with CMOS/TTL output for easy designs: No data encoding or digitizing circuitry required
- Pulse width distortion controlled to limit distortion from low duty cycle or burst mode data
- High noise immunity
- Compatible with Avago's versatile link family of connectors, for easy termination of fiber

### Applications

- Industrial control and factory automation
- Serial field buses
- Intra-system links; board-to-board, rack-to-rack
- Extension of RS-232, RS-485
- Elimination of ground loops
- High voltage isolation
- Reduces voltage transient susceptibility

HCS® is a registered trademark of SpecTran Corporation.

**CAUTION:** It is advised that normal static precautions be taken in handling and assembly of these components to prevent damage and/or degradation which may be induced by ESD.

## HFBR-0508Z Series 10 MBd Data Link

Typical Link Performance,  $T_A = +25^\circ\text{C}$

Parameter	Symbol	Typ. <sup>[1]</sup>	Unit	Condition	Note
Signaling Rate	$f_S$	15	Mb/s	NRZ	2
Link Distance with Extra Low Loss POF Cable	$\ell$	100	m	10 MBd	2, 3, 5
Link Distance with 200 $\mu\text{m}$ HCS Cable	$\ell$	900	m	10 MBd	2, 4, 5

Specified Link Performance,  $T_A = -40^\circ$  to  $+85^\circ\text{C}$ , DC to 10 MBd, unless otherwise noted.

Parameter	Symbol	Min.	Max.	Unit	Condition	Note
Signaling Rate	$f_S$	DC	10	Mb/s	NRZ	2
Link Distance with Extra Low Loss POF Cable	$\ell$	0.1	50	m	+25°C	2, 3, 5
		0.1	40		0 to +70°C	
		0.1	30		-40 to +85°C	
Link Distance with 200 $\mu\text{m}$ HCS Cable	$\ell$	0.1	500	m	+25°C	2, 4, 5
		0.1	300		0 to +70°C	
		0.1	100		-40 to +85°C	
Pulse Width Distortion	PWD	-30	+30	ns	25 – 75% Duty Cycle	2
		-50	+50	ns	Arbitrary Duty Cycle	

## Absolute Maximum Ratings

Parameter	Symbol	Min.	Max.	Unit	Note	
Storage and Operating Temperature	$T_{S,0}$	-40	+85	°C		
Receiver Supply Voltage	$V_{CC}$	-0.5	+5.5	V		
Receiver Average Output Current	$I_{O,AVG}$	-16	+16	mA		
Receiver Output Power Dissipation	$P_{OD}$		80	mW		
Transmitter Peak Forward Input Current	$I_{F,PK}$		90	mA	6	
Transmitter Average Forward Input Current	$I_{F,AVG}$		60	mA		
Transmitter Reverse Input Voltage	$V_R$		3	V		
Lead Soldering Cycle	Temp	$T_{SOL}$		+260	°C	7
	Time			10	sec	7

## Recommended Operating Conditions

Parameter	Symbol	Min.	Max.	Unit	Condition	Note
Ambient Temperature	$T_A$	-40	+85	°C		
Power Supply Voltage	$V_{CC}$	4.75	5.25	V	<100 mV <sub>p-p</sub> Noise	
Transmitter Peak Forward Current	$I_{F,PK}$	20	90	mA		6
Transmitter Average Forward Current	$I_{F,AV}$		60	mA		
Fanout (7400 Series TTL)	N		1			

### Notes:

- Typical data at +25°C,  $V_{CC} = 5\text{ V}$ .
- With recommended transmitter and receiver application circuits (60 mA nominal drive current).
- POF is HFBR-R/EXXYYYY plastic (1 mm) optical fiber. Worst case attenuation used (0.23 dB/m from -40°C to +85°C at 660 nm).
- HCS is HFBR-H/VXXYYYY hard clad silica (200/230  $\mu\text{m}$ ) fiber. Worst case attenuation is used (10 dB/km from 0°C to +70°C and 12 dB/km from -40°C to +85°C at 650 nm).
- $\text{BER} \leq 10^{-9}$ , 2<sup>23</sup> - 1 PRBS NRZ 10 MBd.
- For  $I_{F,PK} > 60\text{ mA}$ , the duty factor must maintain  $I_{F,AV} \leq 60\text{ mA}$  and pulse with  $\leq 1\ \mu\text{s}$ .
- 1.6 mm below seating plane.

### HFBR-1528Z Transmitter

The HFBR-1528Z transmitter incorporates a 650 nm LED in a light gray, nonconductive plastic housing. The high light output power enables the use of both plastic optical fiber (POF) and

Hard Clad Silica (HCS) fiber. This transmitter can be operated up to 10 Mbd using a simple driver circuit. The HFBR-1528Z is compatible with all Versatile Link connectors.

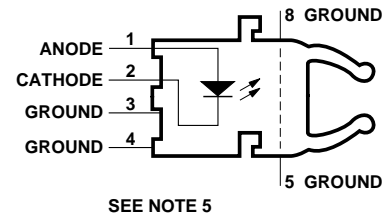

HFBR-1528Z Transmitter, top view

**Electrical and Optical Characteristics:**  $T_A = -40^\circ$  to  $+85^\circ\text{C}$  unless otherwise noted.

Parameter	Symbol	Min.	Typ. <sup>[1]</sup>	Max.	Units	$T_A$ ( $^\circ\text{C}$ )	Conditions	Note
Peak Output Power 1 mm POF, 60 mA	$P_T$	-6.0	-3.5	0.0	dBm	+25	$I_{F,dc} = 60$ mA	2, 3 Fig. 2
		-6.9		+0.5		0 to +70		
		-7.2		+1.3		-40 to +85		
Peak Output Power 1 mm POF, 20 mA	$P_T$	-15.6	-9.0	-2.0	dBm	+25	$I_{F,dc} = 20$ mA	2, 3 Fig. 2
		-16.5		-1.5		0 to +70		
		-16.8		-0.7		-40 to +85		
Peak Output Power 200 $\mu\text{m}$ HCS, 60 mA	$P_T$	-16.1	-12.5	-8.5	dBm	+25	$I_{F,dc} = 60$ mA	2, 3 Fig. 2
		-17.0		-8.0		0 to +70		
		-17.3		-7.2		-40 to +85		
Optical Power Tem- perature Coefficient	$\Delta P_T / \Delta T$		-0.40		%/°C			
			-0.02			dB/°C		
Peak Emission Wavelength	$\lambda_p$	640	650	660	nm	0 to +70		Fig. 3
		635		662		-40 to +85		
Peak Wavelength Temperature Coefficient	$\Delta \lambda / \Delta T$		0.12		nm/°C			
Spectral Width	FWHM		21		nm			Fig. 3
Forward Voltage	$V_F$	1.8	2.1	2.65	V		$I_{F,dc} = 60$ mA	Fig. 1
Forward Voltage Tem- perature Coefficient	$\Delta V_F / \Delta T$		-1.8		mV/°C			Fig. 1
Reverse Input Break- down Voltage	$V_{BR}$	3.0	13		V		$I_{F,dc} = -10$ $\mu\text{A}$	
Diode Capacitance	$C_O$		60		pF		$V_F = 0$ V, $f = 1$ MHz	
Transmitter Numerical Aperture	NA		0.5					
Thermal Resistance, Junction to Case	$\theta_{jc}$		140		°C/W			4
50 $\Omega$ Optical Rise Time	$t_r$		13		ns		10% to 90%, $I_F = 60$ mA	
50 $\Omega$ Optical Fall Time	$t_f$		10		ns			

**Notes:**

- Typical data are at 25°C.
- Optical power measured at the end of 0.5 meters of 1 mm diameter plastic or 200  $\mu\text{m}$  diameter hard clad silica fiber with a large area detector.
- Minimum and maximum values for  $P_T$  over temperature are based on a fixed drive current. The recommended drive circuit has temperature compensation which reduces the variation in  $P_T$  over temperature; refer to Figures 4 and 6.
- Typical value measured from junction to PC board solder joint for horizontal mount package, HFBR-1528Z.
- Pins 5 and 8 are for mounting and retaining purposes, but are electrically connected; pins 3 and 4 are electrically isolated. It is recommended that pins 3, 4, 5 and 8 all be connected to ground to reduce coupling of electrical noise.
- Refer to the "Plastic Optical Fiber and HCS Fiber Cable and Connectors for Versatile Link" Technical Data Sheet for cable connector options for 1 mm plastic and 200  $\mu\text{m}$  HCS optical fiber.

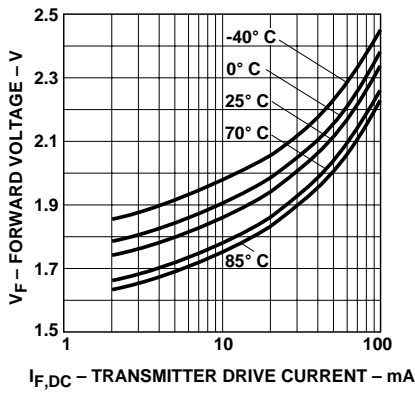

Figure 1. Typical forward voltage vs. drive current.

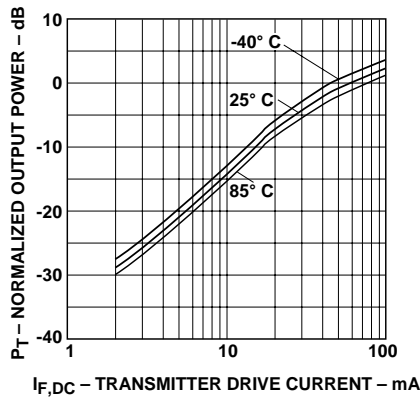

Figure 2. Typical normalized optical power vs. drive current.

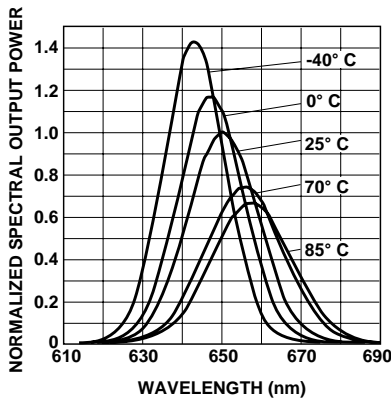

Figure 3. Typical normalized optical spectra.

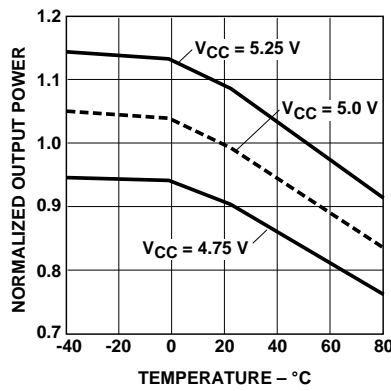

Figure 4. Typical normalized optical power vs. temperature (in recommended drive circuit).

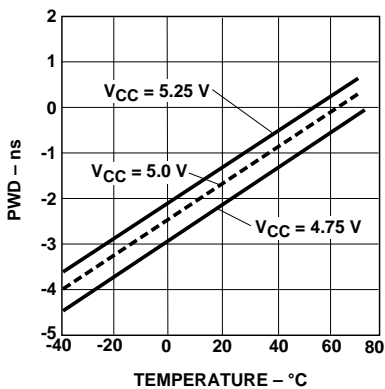

Figure 5. Typical optical pulse width distortion vs. temperature and power supply voltage (in recommended drive circuit).

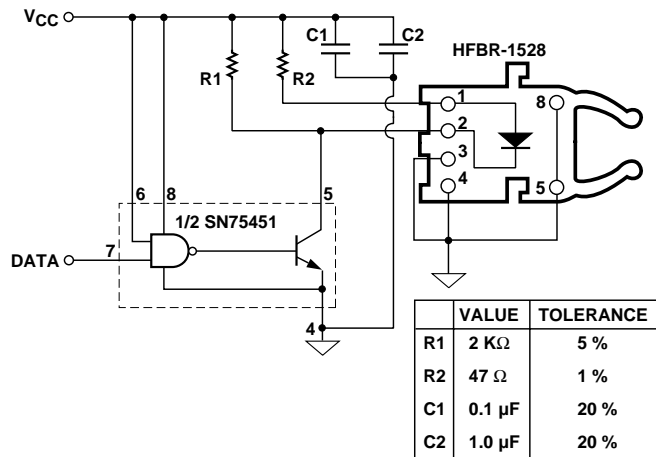

Figure 6. Recommended transmitter drive circuit ( $I_{F,on} = 60$  mA nominal at  $T_A = 25^\circ\text{C}$ ).

**WARNING: WHEN VIEWED UNDER SOME CONDITIONS, THE OPTICAL PORT MAY EXPOSE THE EYE BEYOND THE MAXIMUM PERMISSIBLE EXPOSURE RECOMMENDED IN ANSI Z136.2, 1993. UNDER MOST VIEWING CONDITIONS THERE IS NO EYE HAZARD.**

### HFBR-2528Z Receiver

The HFBR-2528Z receiver consists of a silicon PIN photodiode and digitizing IC to produce a logic compatible output. The IC includes a unique circuit to correct the pulse width distortion of the first bit after a long idle period. This enables operation

from DC to 10 MBd with low PWD for arbitrary data patterns.

The receiver output is a “push-pull” stage compatible with TTL and CMOS logic. The receiver housing is a dark, conductive plastic, compatible with all Versatile Link connectors.

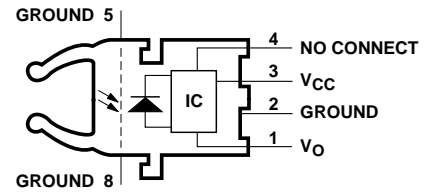

SEE NOTES 5,7

HFBR-2528Z Receiver, top view

**Electrical and Optical Characteristics:**  $T_A = -40^\circ$  to  $+85^\circ\text{C}$ ,  $4.75\text{ V} < V_{CC} < 5.25\text{ V}$ , unless otherwise noted.

Parameter	Symbol	Min.	Typ. <sup>[1]</sup>	Max.	Unit	$T_A$ ( $^\circ\text{C}$ )	Condition	Note	Fig.
Peak POF Sensitivity: Minimum Input for Logic "0"	$P_{RL,min}$		-23.0	-21.0 -20.0 -19.5	dBm	+25 0 to +70 -40 to +85	1 mm POF,  PWD  < 30 ns	2,6	2,4
Peak POF Overdrive Limit: Maximum Input for Logic "0"	$P_{RL,max}$	+1.0 +0.0 -1.0	+5.0		dBm	+25 0 to +70 -40 to +85	1 mm POF,  PWD  < 30 ns	2,3, 6	1,2, 3
Peak POF Off State Limit: Maximum Input for Logic "1"	$P_{RH,max}$			-42	dBm		1 mm POF	2,6, 8	
Peak HCS Sensitivity: Minimum Input for Logic "0"	$P_{RL,min}$		-25.0	-23.0 -22.0 -21.5	dBm	+25 0 to +70 -40 to +85	200 $\mu\text{m}$ HCS,  PWD  < 30 ns	2,6	
Peak HCS Overdrive Limit: Maximum Input for Logic "0"	$P_{RL,max}$	-1.0 -2.0 -3.0	+3.0		dBm	+25 0 to +70 -40 to +85	200 $\mu\text{m}$ HCS,  PWD  < 30 ns	2,3, 6	
Peak HCS Off State Limit: Maximum Input for Logic "1"	$P_{RH,max}$			-44	dBm		200 $\mu\text{m}$ HCS	2,6, 8	
Supply Current	$I_{CC}$		27	45	mA		$V_O = \text{Open}$		
High Level Output Voltage	$V_{OH}$	4.2	4.7		V		$I_O = -40\ \mu\text{A}$		
Low Level Output Voltage	$V_{OL}$		0.22	0.4	V		$I_O = +1.6\ \text{mA}$		
Output Rise Time	$t_r$		12	30	ns		$C_L = 10\ \text{pF}$	6	
Output Fall Time	$t_f$		10	30	ns		$C_L = 10\ \text{pF}$	6	
Thermal Resistance, Junction to Case	$\theta_{jc}$		200		$^\circ\text{C}/\text{W}$			4	
Electric Field Immunity	$E_{MAX}$		8		V/m		Near Field, Electrical Field Source	5	
Power Supply Noise Immunity	PSNI	0.1	0.4		$V_{pp}$		Sine Wave DC - 10 MHz	6	

#### Notes:

- Typical data are at  $+25^\circ\text{C}$ ,  $V_{CC} = 5.0\text{ V}$ .
- Input power levels are for peak (not average) optical input levels. For 50% duty cycle data, peak optical power is twice the average optical power.
- Receiver overdrive ( $P_{RL,max}$ ) is specified as the limit where |PWD| will not exceed 30 ns. The receiver will be in the correct state (logic "0") for optical powers above  $P_{RL,max}$ . However, it may not meet a 30% symbol period PWD if the overdrive limit is exceeded. Refer to Figure 2 for PWD performance at high received optical powers.
- Typical value measured from junction to PC board solder joint for horizontal mount package, HFBR-2528Z.
- Pins 5 and 8 are electrically connected to the conductive housing and are also used for mounting and retaining purposes. It is required that pins 5 and 8 be connected to ground to maintain conductive housing shield effectiveness.
- In recommended receiver circuit, with an optical signal from the recommended transmitter circuit.
- Pin 4 is electrically isolated internally. Pin 4 may be externally connected to pin 1 for board layout compatibility with HFBR-25X1Z, HFBR-25X2Z and HFBR-25X4Z. Otherwise it is recommended pin 4 be grounded as in Figure 5.
- $\text{BER} \leq 10\text{E}-9$ , includes a 10.8 dB margin below the receiver switching threshold level (signal to noise ratio = 12).

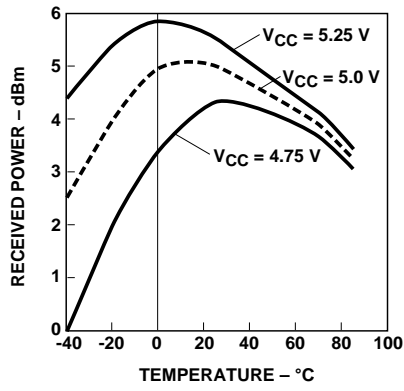

Figure 1. Typical POF receiver overdrive,  $P_{RL,max}$ , at 10 MBd, vs. temperature and power supply voltage.

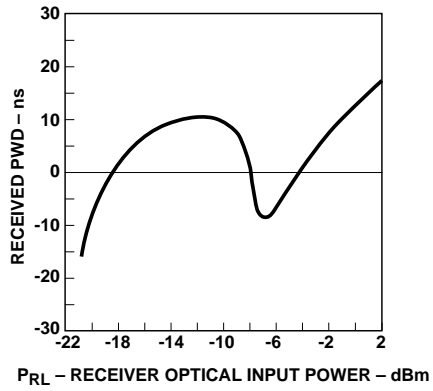

Figure 2. Typical POF receiver pulse width distortion vs. optical power at 10 MBd.

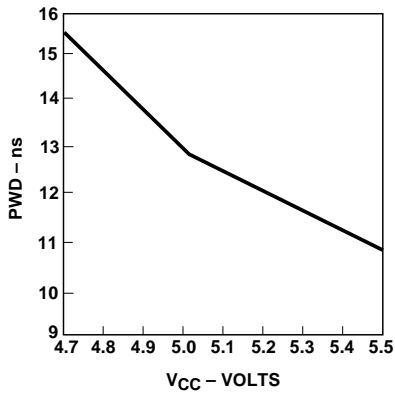

Figure 3. Typical POF receiver pulse width distortion vs. power supply voltage at high optical power (0 dBm,pk, 10 MBd).

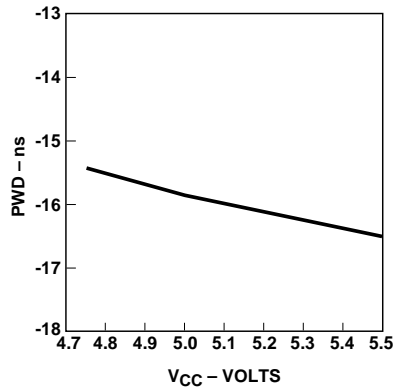

Figure 4. Typical POF receiver pulse width distortion vs. power supply voltage at low optical power, (-21 dBm,pk, 10 MBd).

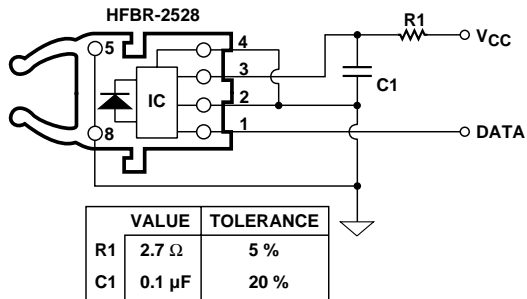

Figure 5. Recommended receiver application circuit.

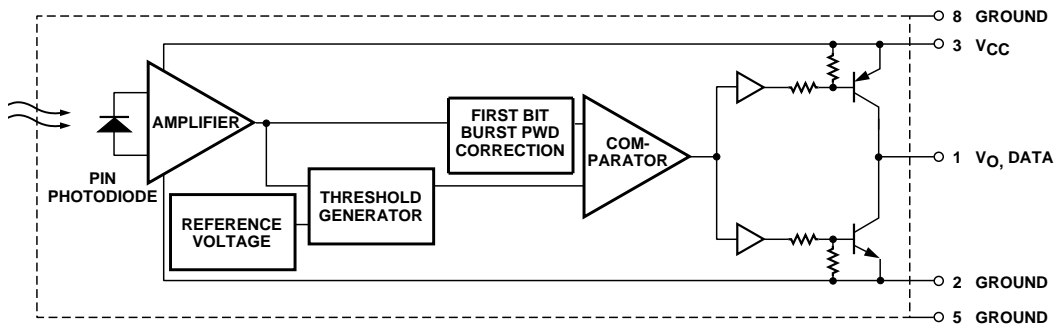
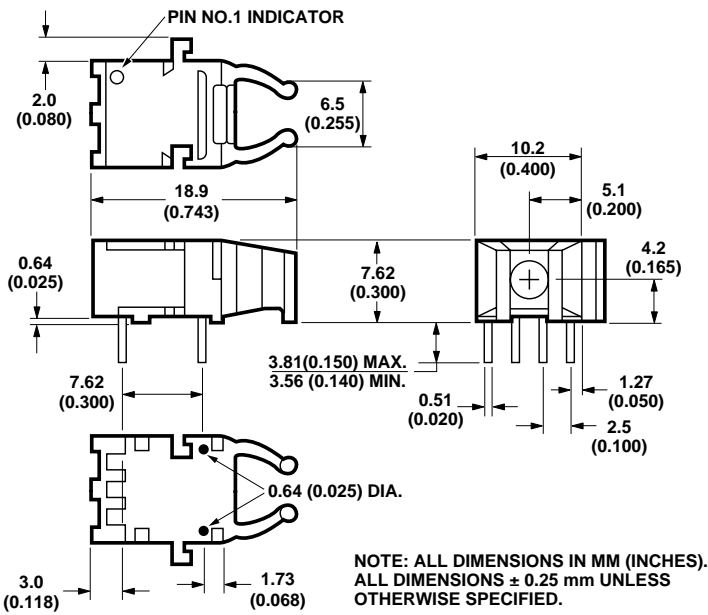
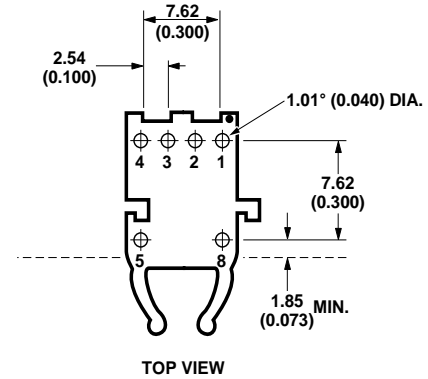

Figure 6. HFBR-2528Z receiver block diagram.

### Versatile Link Mechanical Dimensions



### Versatile Link Printed Circuit Board Layout Dimensions



#### ELECTRICAL PIN FUNCTIONS

PIN NO.	TRANSMITTER HFBR-1528	RECEIVER HFBR-2528
1	ANODE	SIGNAL, $V_O$
2	CATHODE	GROUND
3	GROUND*	$V_{CC}$ (+5 V)
4	GROUND*	GROUND*
5	GROUND**	GROUND**
8	GROUND**	GROUND**

\* NO INTERNAL CONNECTION, GROUND CONNECTION RECOMMENDED.  
\*\* PINS 5 AND 8 CONNECTED INTERNALLY TO EACH OTHER.

For product information and a complete list of distributors, please go to our website: [www.avagotech.com](http://www.avagotech.com)

Avago, Avago Technologies, and the A logo are trademarks of Avago Technologies, Pte. in the United States and other countries.  
Data subject to change. Copyright © 2006 Avago Technologies Pte. All rights reserved.  
5989-4632EN 1/24/06

