

TrenchP™
Power MOSFETs

IXTA96P085T
IXTP96P085T
IXTH96P085T

$V_{DSS} = -85V$
 $I_{D25} = -96A$
 $R_{DS(on)} \leq 13m\Omega$

P-Channel Enhancement Mode
Avalanche Rated

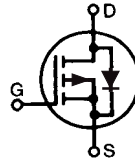

Symbol	Test Conditions	Maximum Ratings	
V_{DSS}	$T_J = 25^\circ C$ to $150^\circ C$	- 85	V
V_{DGR}	$T_J = 25^\circ C$ to $150^\circ C$, $R_{GS} = 1M\Omega$	- 85	V
V_{GSS}	Continuous	± 15	V
V_{GSM}	Transient	± 25	V
I_{D25}	$T_C = 25^\circ C$	- 96	A
I_{DM}	$T_C = 25^\circ C$, Pulse Width Limited by T_{JM}	- 300	A
I_A	$T_C = 25^\circ C$	- 48	A
E_{AS}	$T_C = 25^\circ C$	1	J
P_D	$T_C = 25^\circ C$	298	W
T_J		-55 ... +150	$^\circ C$
T_{JM}		150	$^\circ C$
T_{stg}		-55 ... +150	$^\circ C$
T_L	1.6mm (0.062 in.) from Case for 10s	300	$^\circ C$
T_{sOLD}	Plastic Body for 10s	260	$^\circ C$
M_d	Mounting Torque (TO-220 & TO-247)	1.13/10	Nm/lb.in.
Weight	TO-263	2.5	g
	TO-220	3.0	g
	TO-247	6.0	g

Symbol	Test Conditions ($T_J = 25^\circ C$, Unless Otherwise Specified)	Characteristic Values		
		Min.	Typ.	Max.
BV_{DSS}	$V_{GS} = 0V$, $I_D = -250\mu A$	- 85		V
$V_{GS(th)}$	$V_{DS} = V_{GS}$, $I_D = -250\mu A$	- 2.0		- 4.0 V
I_{GSS}	$V_{GS} = \pm 15V$, $V_{DS} = 0V$			± 100 nA
I_{DSS}	$V_{DS} = V_{DSS}$, $V_{GS} = 0V$			- 10 μA - 750 μA
$R_{DS(on)}$	$V_{GS} = -10V$, $I_D = 0.5 \cdot I_{D25}$, Note 1 $T_J = 125^\circ C$			13 m Ω

TO-263 AA (IXTA)

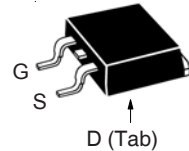

TO-220AB (IXTP)

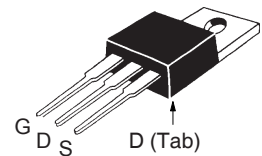

TO-247 (IXTH)

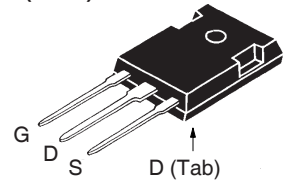

G = Gate D = Drain
S = Source Tab = Drain

Features

- International Standard Packages
- Avalanche Rated
- Extended FBSOA
- Fast Intrinsic Diode
- Low $R_{DS(ON)}$ and Q_G

Advantages

- Easy to Mount
- Space Savings
- High Power Density

Applications

- High-Side Switching
- Push Pull Amplifiers
- DC Choppers
- Automatic Test Equipment
- Current Regulators
- Battery Charger Applications

Symbol	Test Conditions ($T_J = 25^\circ\text{C}$, Unless Otherwise Specified)	Characteristic Values		
		Min.	Typ.	Max.
g_{fs}	$V_{DS} = -10\text{V}$, $I_D = 0.5 \cdot I_{D25}$, Note 1	40	66	S
C_{iss}	$V_{GS} = 0\text{V}$, $V_{DS} = -25\text{V}$, $f = 1\text{MHz}$		13.1	nF
C_{oss}			1175	pF
C_{rss}			460	pF
$t_{d(on)}$	Resistive Switching Times $V_{GS} = -10\text{V}$, $V_{DS} = 0.5 \cdot V_{DSS}$, $I_D = 0.5 \cdot I_{D25}$ $R_G = 1\Omega$ (External)		23	ns
t_r			34	ns
$t_{d(off)}$			45	ns
t_f			22	ns
$Q_{g(on)}$	$V_{GS} = -10\text{V}$, $V_{DS} = 0.5 \cdot V_{DSS}$, $I_D = 0.5 \cdot I_{D25}$		180	nC
Q_{gs}			52	nC
Q_{gd}			62	nC
R_{thJC}			0.42	$^\circ\text{C/W}$
R_{thCS}	TO-220	0.50		$^\circ\text{C/W}$
	TO-247	0.21		$^\circ\text{C/W}$

Source-Drain Diode

Symbol	Test Conditions ($T_J = 25^\circ\text{C}$, Unless Otherwise Specified)	Characteristic Values		
		Min.	Typ.	Max.
I_S	$V_{GS} = 0\text{V}$			-96 A
I_{SM}	Repetitive, Pulse Width Limited by T_{JM}			-394 A
V_{SD}	$I_F = -48\text{A}$, $V_{GS} = 0\text{V}$, Note 1			-1.3 V
t_{rr}	$I_F = -48\text{A}$, $-di/dt = -100\text{A}/\mu\text{s}$ $V_R = -43\text{V}$, $V_{GS} = 0\text{V}$		55	ns
Q_{RM}			100	nC
I_{RM}			-3.6	A

Note 1. Pulse test, $t \leq 300\mu\text{s}$, duty cycle, $d \leq 2\%$.

TO-263 Outline

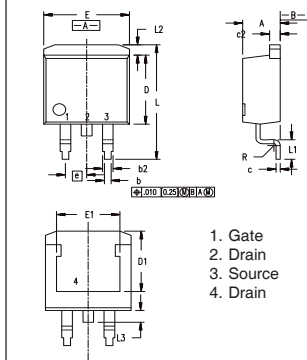

1. Gate
2. Drain
3. Source
4. Drain

Dim.	Millimeter		Inches	
	Min.	Max.	Min.	Max.
A	4.06	4.83	.160	.190
b	0.51	0.99	.020	.039
b2	1.14	1.40	.045	.055
c	0.40	0.74	.016	.029
c2	1.14	1.40	.045	.055
D	8.64	9.65	.340	.380
D1	8.00	8.89	.280	.320
E	9.65	10.41	.380	.405
E1	6.22	8.13	.270	.320
e	2.54	BSC	.100	BSC
L	14.61	15.88	.575	.625
L1	2.29	2.79	.090	.110
L2	1.02	1.40	.040	.055
L3	1.27	1.78	.050	.070
L4	0	0.13	0	.005

TO-247 Outline

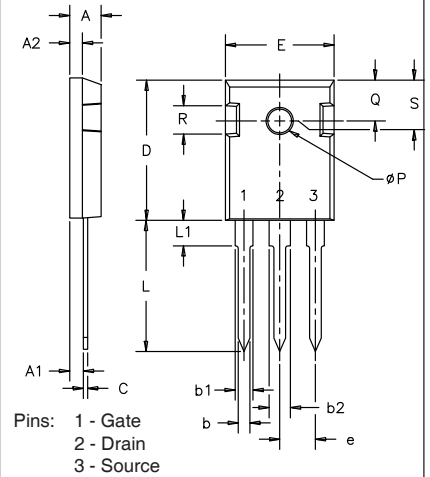

- Pins: 1 - Gate
2 - Drain
3 - Source

SYM	INCHES		MILLIMETERS	
	MIN	MAX	MIN	MAX
A	.185	.209	4.7	5.3
A1	.087	.102	2.2	2.54
A2	.059	.098	2.2	2.6
b	.040	.055	1.0	1.4
b1	.065	.084	1.65	2.13
b2	.113	.123	2.87	3.12
C	.016	.031	.4	.8
D	.819	.845	20.80	21.46
E	.610	.640	15.75	16.26
e	.215	BSC	5.45	BSC
L	.780	.800	19.81	20.32
L1		.177		4.50
ϕP	.140	.144	3.55	3.65
Q	.212	.244	5.4	6.2
R	.170	.216	4.32	5.49
S	.242	BSC	6.15	BSC

TO-220 Outline

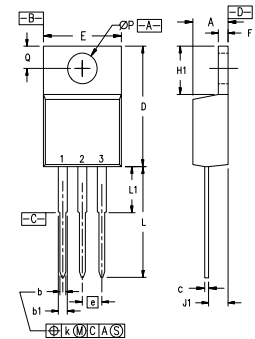

- Pins: 1 - Gate
2 - Drain
3 - Source

SYM	INCHES		MILLIMETERS	
	MIN	MAX	MIN	MAX
A	.170	.190	4.32	4.83
b	.025	.040	0.64	1.02
b1	.045	.065	1.15	1.65
c	.014	.022	0.35	0.56
D	.580	.630	14.73	16.00
E	.390	.420	9.91	10.66
e	.100	BSC	2.54	BSC
F	.045	.055	1.14	1.40
H1	.230	.270	5.85	6.85
J1	.090	.110	2.29	2.79
k	0	.015	0	0.38
L	.500	.550	12.70	13.97
L1	.110	.230	2.79	5.84
ϕP	.139	.161	3.53	4.08
Q	.100	.125	2.54	3.18

IXYS Reserves The Right to Change Limits, Test Conditions, and Dimensions.

IXYS MOSFETs and IGBTs are covered 4,835,592 4,931,844 5,049,961 5,237,481 6,162,665 6,404,065 B1 6,683,344 6,727,585 7,005,734 B2 7,157,338B2
by one or more of the following U.S. patents: 4,860,072 5,017,508 5,063,307 5,381,025 6,259,123 B1 6,534,343 6,710,405 B2 6,759,692 7,063,975 B2
4,881,106 5,034,796 5,187,117 5,486,715 6,306,728 B1 6,583,505 6,710,463 6,771,478 B2 7,071,537

Fig. 1. Output Characteristics @ $T_J = 25^\circ\text{C}$

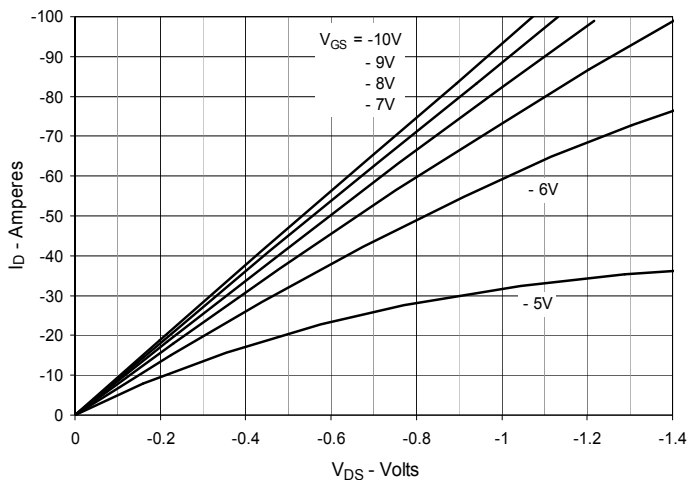

Fig. 2. Extended Output Characteristics @ $T_J = 25^\circ\text{C}$

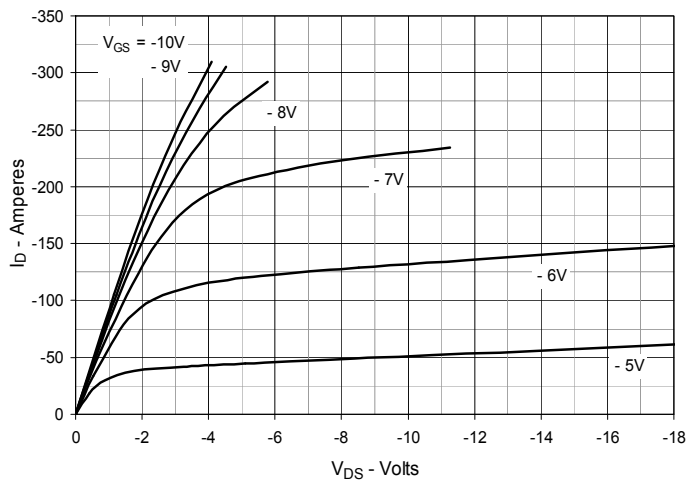

Fig. 3. Output Characteristics @ $T_J = 125^\circ\text{C}$

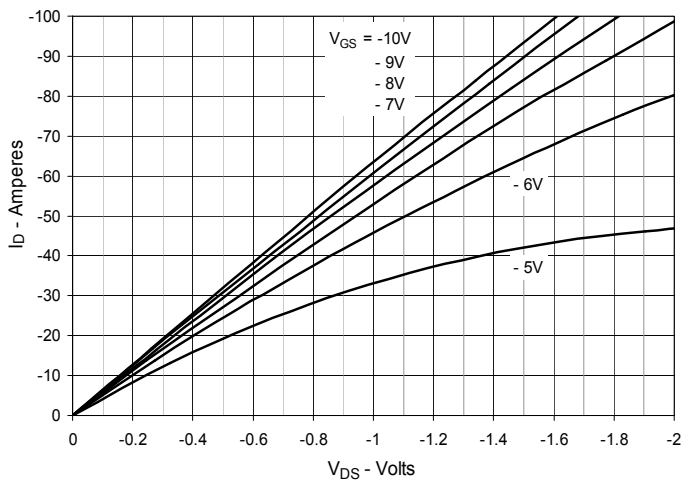

Fig. 4. $R_{DS(on)}$ Normalized to $I_D = -48\text{A}$ Value vs. Junction Temperature

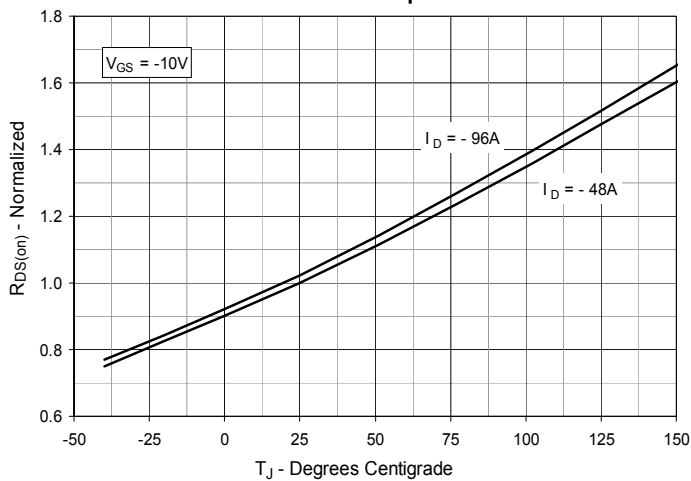

Fig. 5. $R_{DS(on)}$ Normalized to $I_D = -48\text{A}$ Value vs. Drain Current

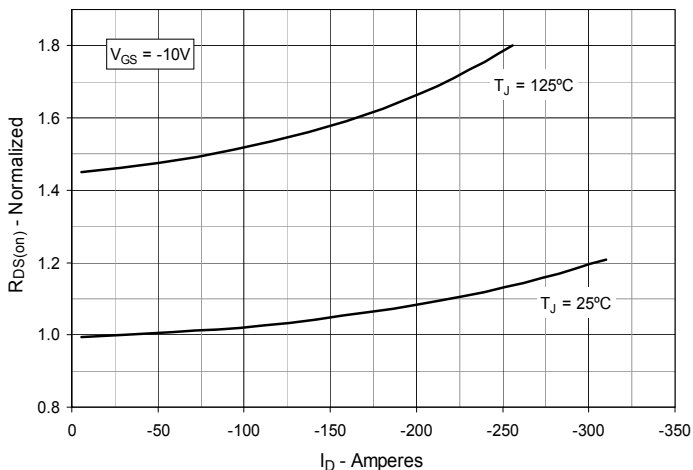

Fig. 6. Maximum Drain Current vs. Case Temperature

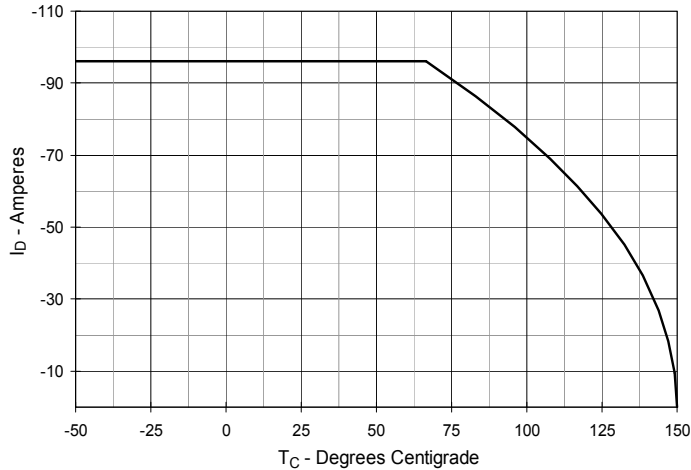

Fig. 7. Input Admittance

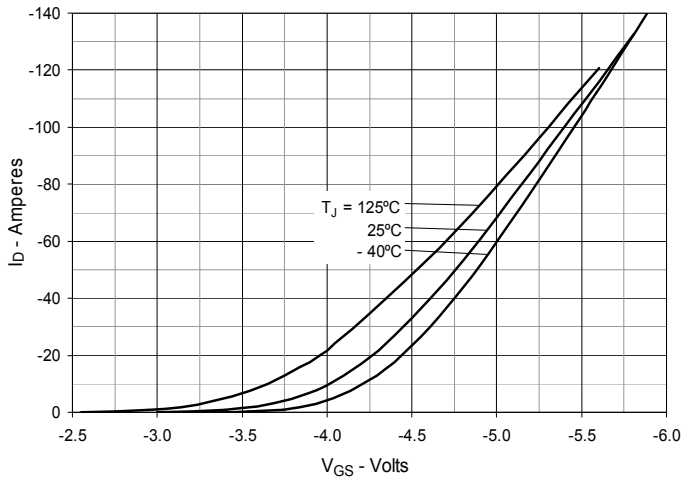

Fig. 8. Transconductance

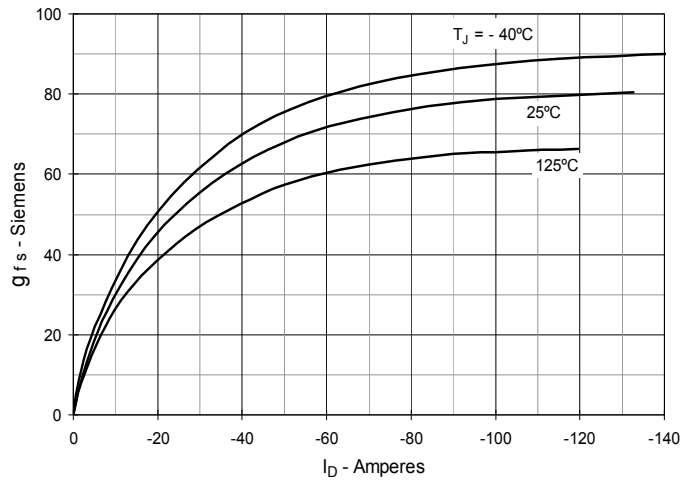

Fig. 9. Forward Voltage Drop of Intrinsic Diode

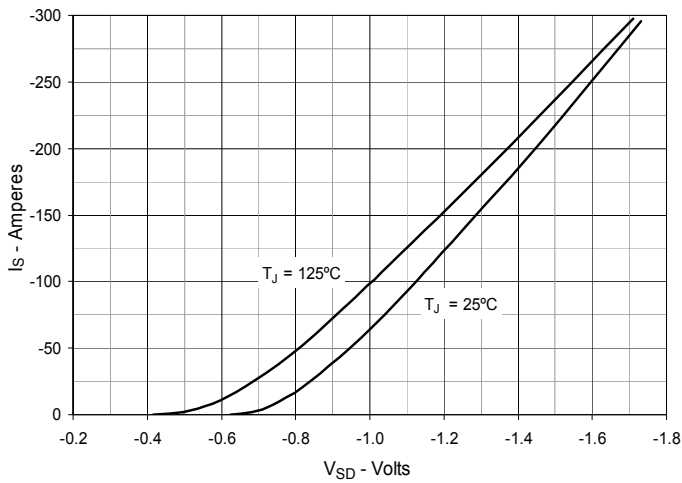

Fig. 10. Gate Charge

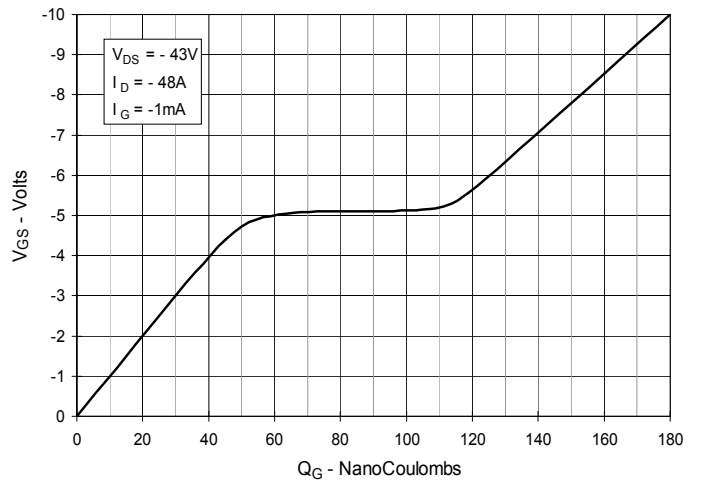

Fig. 11. Capacitance

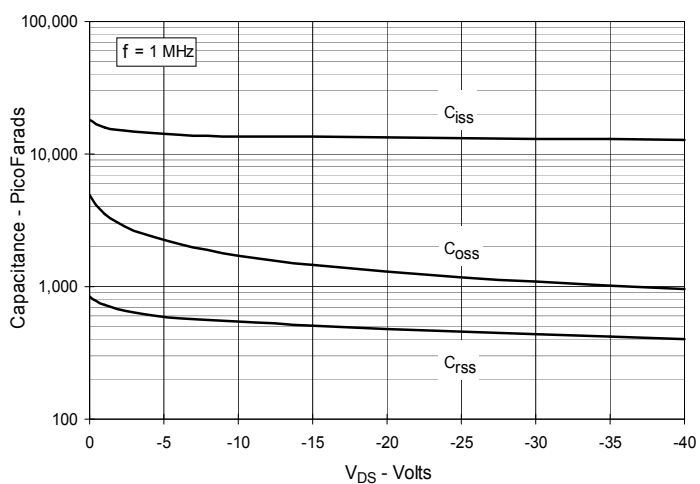

Fig. 12. Forward-Bias Safe Operating Area

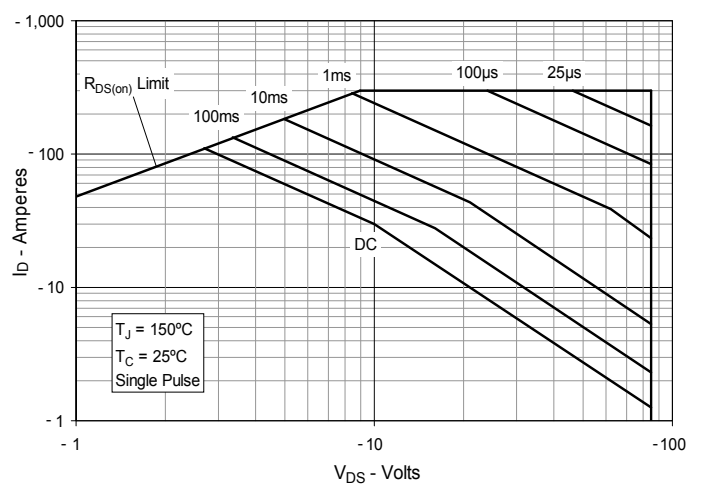

Fig. 13. Resistive Turn-on Rise Time vs. Junction Temperature

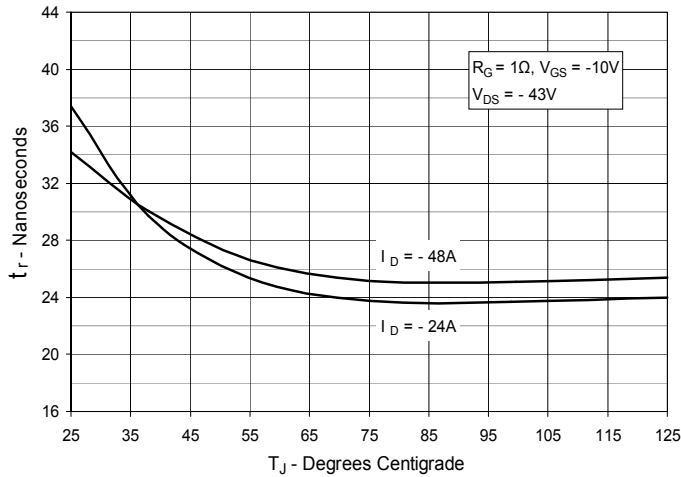

Fig. 14. Resistive Turn-on Rise Time vs. Drain Current

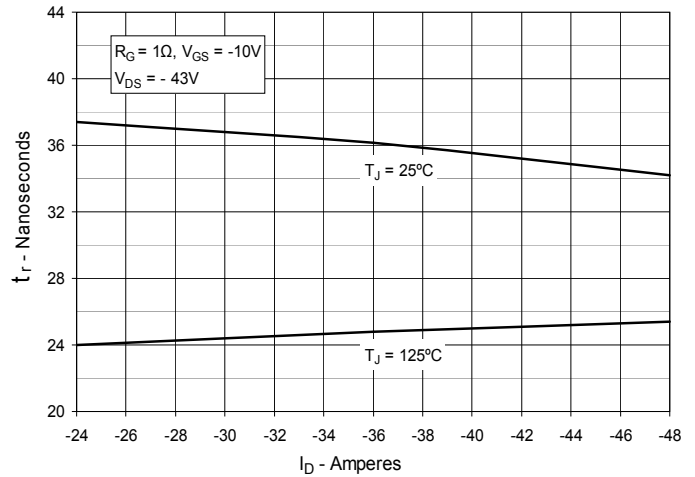

Fig. 15. Resistive Turn-on Switching Times vs. Gate Resistance

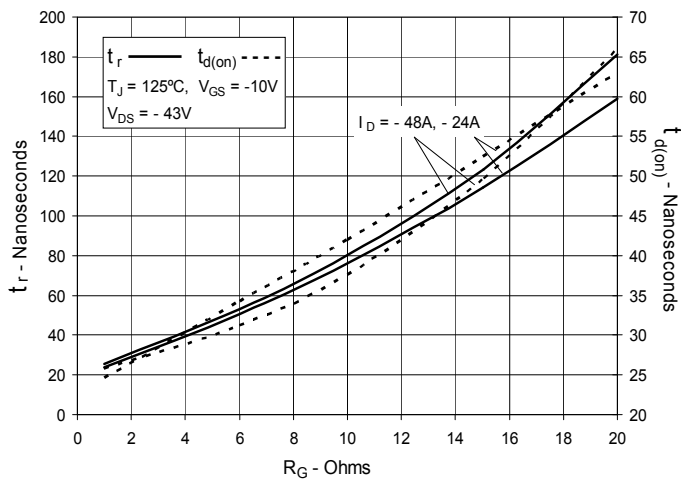

Fig. 16. Resistive Turn-off Switching Times vs. Junction Temperature

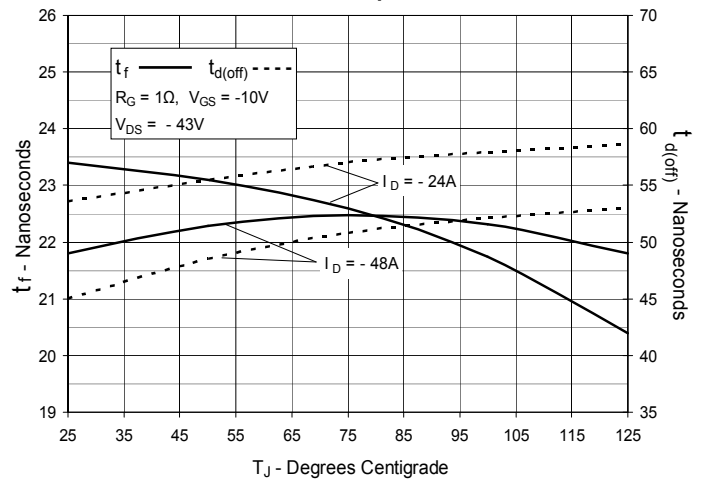

Fig. 17. Resistive Turn-off Switching Times vs. Drain Current

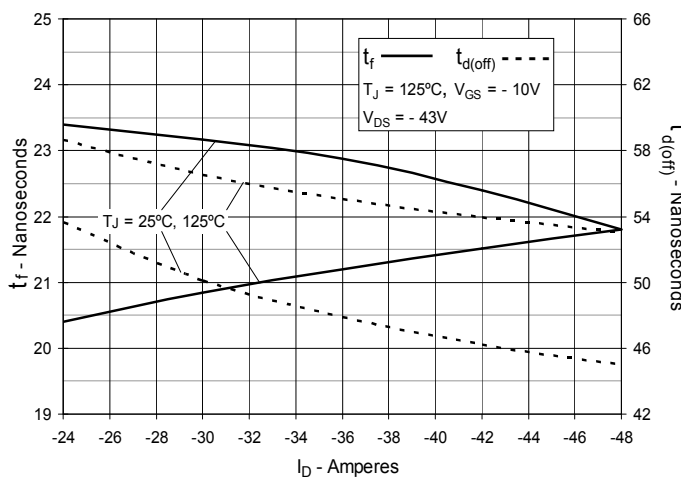

Fig. 18. Resistive Turn-off Switching Times vs. Gate Resistance

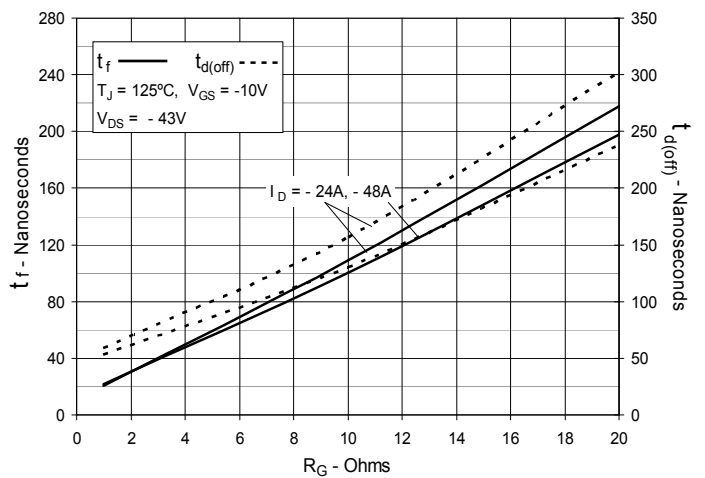

Fig. 19. Maximum Transient Thermal Impedance

