

# DATA SHEET

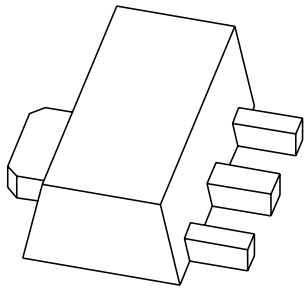

## **BZV49 series** Voltage regulator diodes

Product specification  
Supersedes data of 1999 May 11

2005 Feb 03

# Voltage regulator diodes

# BZV49 series

### FEATURES

- Total power dissipation: max. 1 W
- Tolerance series: approx.  $\pm 5\%$
- Working voltage range: nom. 2.4 to 75 V (E24 range)
- Non-repetitive peak reverse power dissipation: max. 40 W.

### APPLICATIONS

- General regulation functions.

### DESCRIPTION

Medium-power voltage regulator diodes in a SOT89 plastic SMD package.

The diodes are available in the normalized E24 approx.  $\pm 5\%$  tolerance range. The series consists of 37 types with nominal working voltages from 2.4 to 75 V (BZV49-C2V4 to BZV49-C75).

### PINNING

PIN	DESCRIPTION
1	anode
2	cathode
3	anode

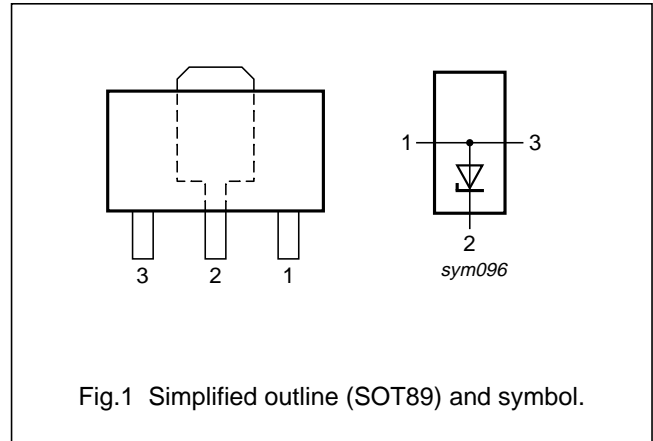

Fig.1 Simplified outline (SOT89) and symbol.

### ORDERING INFORMATION

TYPE NUMBER	PACKAGE		
	NAME	DESCRIPTION	VERSION
BZV49-C2V4 to BZV49-C75 note 1	SC-62	plastic surface mounted package; collector pad for good heat transfer; 3 leads	SOT89

### Note

1. The series consists of 37 types with nominal working voltages from 2.4 to 75 V (E24 range).

### MARKING

TYPE NUMBER	MARKING CODE	TYPE NUMBER	MARKING CODE	TYPE NUMBER	MARKING CODE	TYPE NUMBER	MARKING CODE
BZV49-C2V4	2Y4	BZV49-C6V2	6Y2	BZV49-C16	16Y	BZV49-C43	43Y
BZV49-C2V7	2Y7	BZV49-C6V8	6Y8	BZV49-C18	18Y	BZV49-C47	47Y
BZV49-C3V0	3Y0	BZV49-C7V5	7Y5	BZV49-C20	20Y	BZV49-C51	51Y
BZV49-C3Y3	3Y3	BZV49-C8V2	8Y2	BZV49-C22	22Y	BZV49-C56	56Y
BZV49-C3V6	3Y6	BZV49-C9V1	9Y1	BZV49-C24	24Y	BZV49-C62	62Y
BZV49-C3V9	3Y9	BZV49-C10	10Y	BZV49-C27	27Y	BZV49-C68	68Y
BZV49-C4V3	4Y3	BZV49-C11	11Y	BZV49-C30	30Y	BZV49-C75	75Y
BZV49-C4V7	4Y7	BZV49-C12	12Y	BZV49-C33	33Y	-	-
BZV49-C5V1	5Y1	BZV49-C13	13Y	BZV49-C36	36Y	-	-
BZV49-C5V6	5Y6	BZV49-C15	15Y	BZV49-C39	39Y	-	-

## Voltage regulator diodes

## BZV49 series

**LIMITING VALUES**

In accordance with the Absolute Maximum Rating System (IEC 60134).

SYMBOL	PARAMETER	CONDITIONS	MIN.	MAX.	UNIT
$I_F$	continuous forward current		–	250	mA
$I_{ZSM}$	non-repetitive peak reverse current	$t_p = 100 \mu\text{s}$ ; square wave; $T_j = 25 \text{ }^\circ\text{C}$ prior to surge	see Table "Per type"		
$P_{tot}$	total power dissipation	$T_{amb} = 25 \text{ }^\circ\text{C}$ ; note 1	–	1	W
$P_{ZSM}$	non-repetitive peak reverse power dissipation	$t_p = 100 \mu\text{s}$ ; square wave; $T_j = 25 \text{ }^\circ\text{C}$ prior to surge; see Fig.2	–	40	W
$T_{stg}$	storage temperature		–65	+150	$^\circ\text{C}$
$T_j$	junction temperature		–	150	$^\circ\text{C}$

**Note**

1. Device mounted on a ceramic substrate; area = 2.5 cm<sup>2</sup>; thickness = 0.7 mm.

**ELECTRICAL CHARACTERISTICS****Total series**

$T_{amb} = 25 \text{ }^\circ\text{C}$  unless otherwise specified.

SYMBOL	PARAMETER	CONDITIONS	MAX.	UNIT
$V_F$	forward voltage	$I_F = 50 \text{ mA}$ ; see Fig.3	1	V

## Voltage regulator diodes

## BZV49 series

## Per type

$T_j = 25\text{ °C}$  unless otherwise specified.

BZV49- CXXX	WORKING VOLTAGE $V_Z$ (V) at $I_{Ztest}$		DIFFERENTIAL RESISTANCE $r_{dif}$ ( $\Omega$ ) at $I_{Ztest}$		TEMP. COEFF. $S_Z$ (mV/K) at $I_{Ztest}$ see Figs 4 and 5			TEST CURRENT $I_{Ztest}$ (mA)	DIODE CAP. $C_d$ (pF) at $f = 1\text{ MHz}$ ; at $V_R = 0\text{ V}$	REVERSE CURRENT at REVERSE VOLTAGE		NON-REPETITIVE PEAK REVERSE CURRENT $I_{ZSM}$ (A) at $t_p = 100\text{ }\mu\text{s}$ ; $T_{amb} = 25\text{ °C}$
	MIN.	MAX.	TYP.	MAX.	MIN.	TYP.	MAX.			$I_R$ ( $\mu\text{A}$ )	$V_R$ (V)	
2V4	2.2	2.6	70	100	-3.5	-1.6	0	5	450	50	1.0	6.0
2V7	2.5	2.9	75	100	-3.5	-2.0	0	5	450	20	1.0	6.0
3V0	2.8	3.2	80	95	-3.5	-2.1	0	5	450	10	1.0	6.0
3V3	3.1	3.5	85	95	-3.5	-2.4	0	5	450	5	1.0	6.0
3V6	3.4	3.8	85	90	-3.5	-2.4	0	5	450	5	1.0	6.0
3V9	3.7	4.1	85	90	-3.5	-2.5	0	5	450	3	1.0	6.0
4V3	4.0	4.6	80	90	-3.5	-2.5	0	5	450	3	1.0	6.0
4V7	4.4	5.0	50	80	-3.5	-1.4	+0.2	5	300	3	2.0	6.0
5V1	4.8	5.4	40	60	-2.7	-0.8	+1.2	5	300	2	2.0	6.0
5V6	5.2	6.0	15	40	-2.0	+1.2	+2.5	5	300	1	2.0	6.0
6V2	5.8	6.6	6	10	0.4	2.3	3.7	5	200	3	4.0	6.0
6V8	6.4	7.2	6	15	1.2	3.0	4.5	5	200	2	4.0	6.0
7V5	7.0	7.9	6	15	2.5	4.0	5.3	5	150	1	5.0	4.0
8V2	7.7	8.7	6	15	3.2	4.6	6.2	5	150	0.7	5.0	4.0
9V1	8.5	9.6	6	15	3.8	5.5	7.0	5	150	0.5	6.0	3.0
10	9.4	10.6	8	20	4.5	6.4	8.0	5	90	0.2	7.0	3.0
11	10.4	11.6	10	20	5.4	7.4	9.0	5	85	0.1	8.0	2.5
12	11.4	12.7	10	25	6.0	8.4	10.0	5	85	0.1	8.0	2.5
13	12.4	14.1	10	30	7.0	9.4	11.0	5	80	0.1	8.0	2.5
15	13.8	15.6	10	30	9.2	11.4	13.0	5	75	0.05	10.5	2.0
16	15.3	17.1	10	40	10.4	12.4	14.0	5	75	0.05	11.2	1.5
18	16.8	19.1	10	45	12.4	14.4	16.0	5	70	0.05	12.6	1.5
20	18.8	21.2	15	55	14.4	16.4	18.0	5	60	0.05	14.0	1.5
22	20.8	23.3	20	55	16.4	18.4	20.0	5	60	0.05	15.4	1.25
24	22.8	25.6	25	70	18.4	20.4	22.0	5	55	0.05	16.8	1.25

## Voltage regulator diodes

## BZV49 series

BZV49- CXXX	WORKING VOLTAGE $V_Z$ (V) at $I_{Ztest}$		DIFFERENTIAL RESISTANCE $r_{dif}$ ( $\Omega$ ) at $I_{Ztest}$		TEMP. COEFF. $S_Z$ (mV/K) at $I_{Ztest}$ see Figs 4 and 5			TEST CURRENT $I_{Ztest}$ (mA)	DIODE CAP. $C_d$ (pF) at $f = 1$ MHz; at $V_R = 0$ V	REVERSE CURRENT at REVERSE VOLTAGE		NON-REPETITIVE PEAK REVERSE CURRENT $I_{ZSM}$ (A) at $t_p = 100 \mu s$ ; $T_{amb} = 25^\circ C$
	MIN.	MAX.	TYP.	MAX.	MIN.	TYP.	MAX.			$I_R$ ( $\mu A$ )	$V_R$ (V)	
27	25.1	28.9	25	80	21.4	23.4	25.3	2	50	0.05	18.9	1.0
30	28.0	32.0	30	80	24.4	26.6	29.4	2	50	0.05	21.0	1.0
33	31.0	35.0	35	80	27.4	29.7	33.4	2	45	0.05	23.1	0.9
36	34.0	38.0	35	90	30.4	33.0	37.4	2	45	0.05	25.2	0.8
39	37.0	41.0	40	130	33.4	36.4	41.2	2	45	0.05	27.3	0.7
43	40.0	46.0	45	150	37.6	41.2	46.6	2	40	0.05	30.1	0.6
47	44.0	50.0	50	170	42.0	46.1	51.8	2	40	0.05	32.9	0.5
51	48.0	54.0	60	180	46.6	51.0	57.2	2	40	0.05	35.7	0.4
56	52.0	60.0	70	200	52.2	57.0	63.8	2	40	0.05	39.2	0.3
62	58.0	66.0	80	215	58.8	64.4	71.6	2	35	0.05	43.4	0.3
68	64.0	72.0	90	240	65.6	71.7	79.8	2	35	0.05	47.6	0.25
75	70.0	79.0	95	255	73.4	80.2	88.6	2	35	0.05	52.5	0.2

Voltage regulator diodes

BZV49 series

THERMAL CHARACTERISTICS

SYMBOL	PARAMETER	CONDITIONS	VALUE	UNIT
$R_{th(j-tp)}$	thermal resistance from junction to tie-point		15	K/W
$R_{th(j-a)}$	thermal resistance from junction to ambient	note 1	125	K/W

Note

1. Device mounted on a ceramic substrate; area = 2.5 cm<sup>2</sup>; thickness = 0.7 mm.

GRAPHICAL DATA

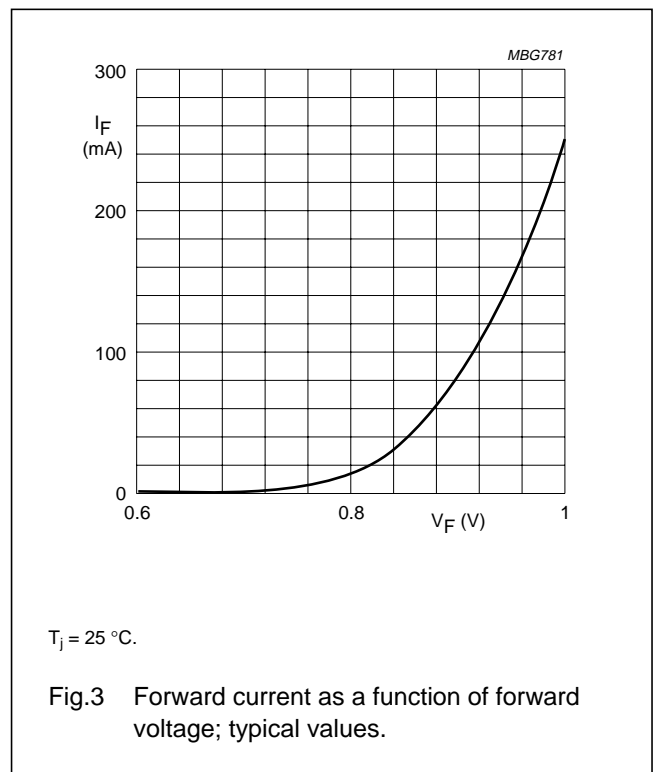
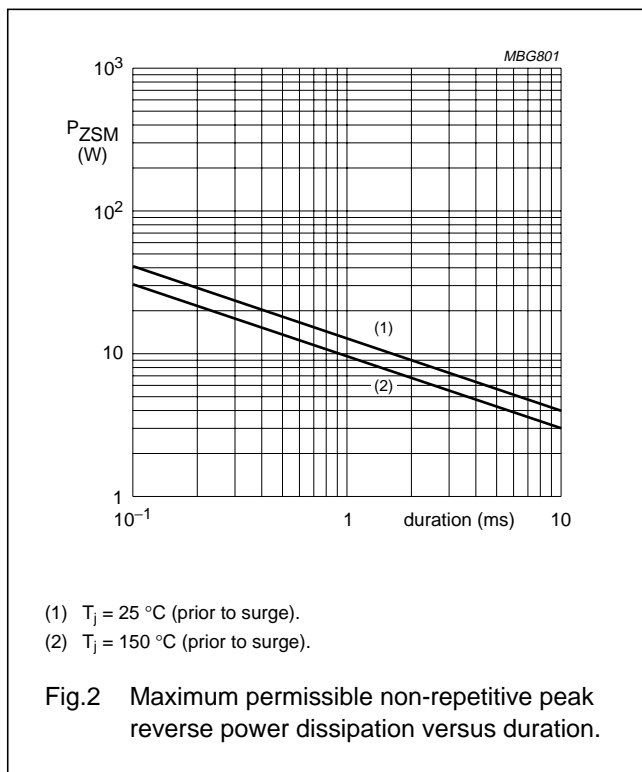

Voltage regulator diodes

BZV49 series

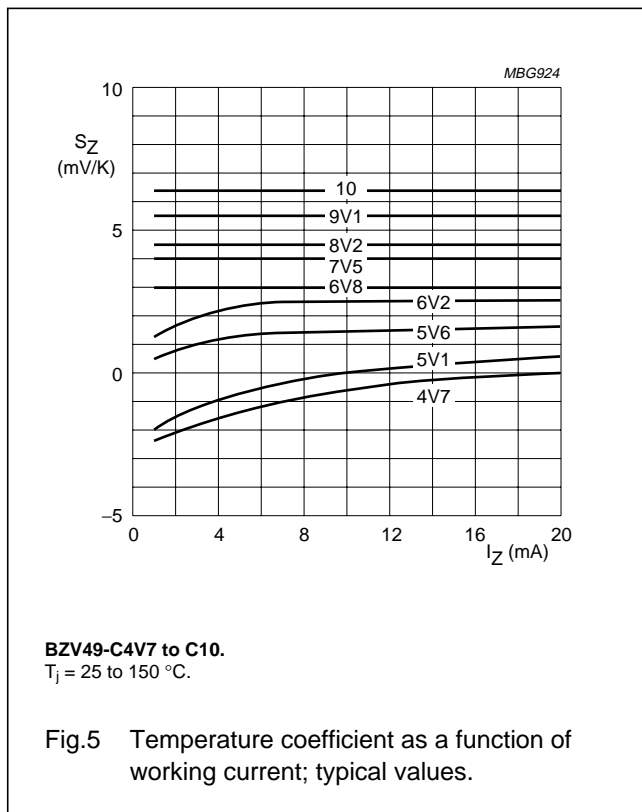
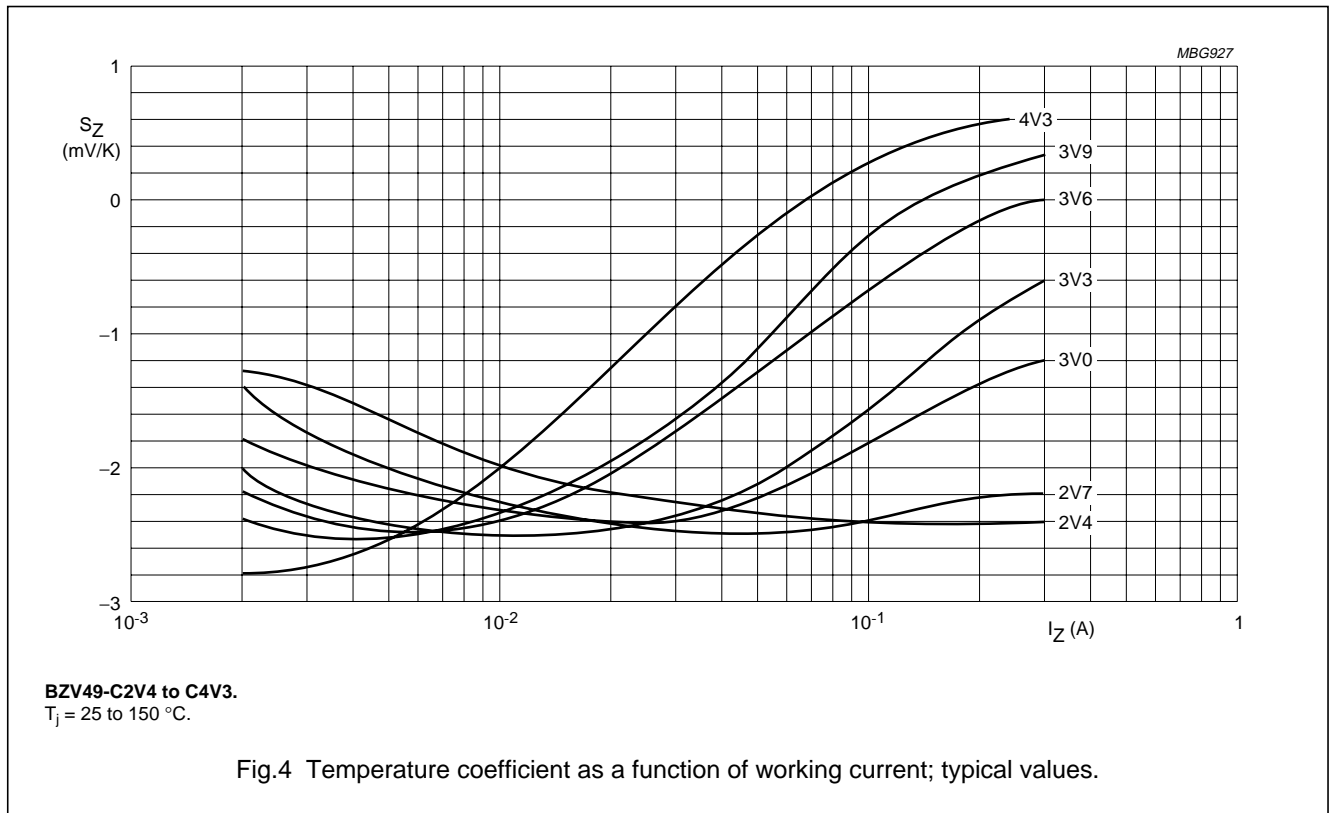

Voltage regulator diodes

BZV49 series

PACKAGE OUTLINE

Plastic surface mounted package; collector pad for good heat transfer; 3 leads

SOT89

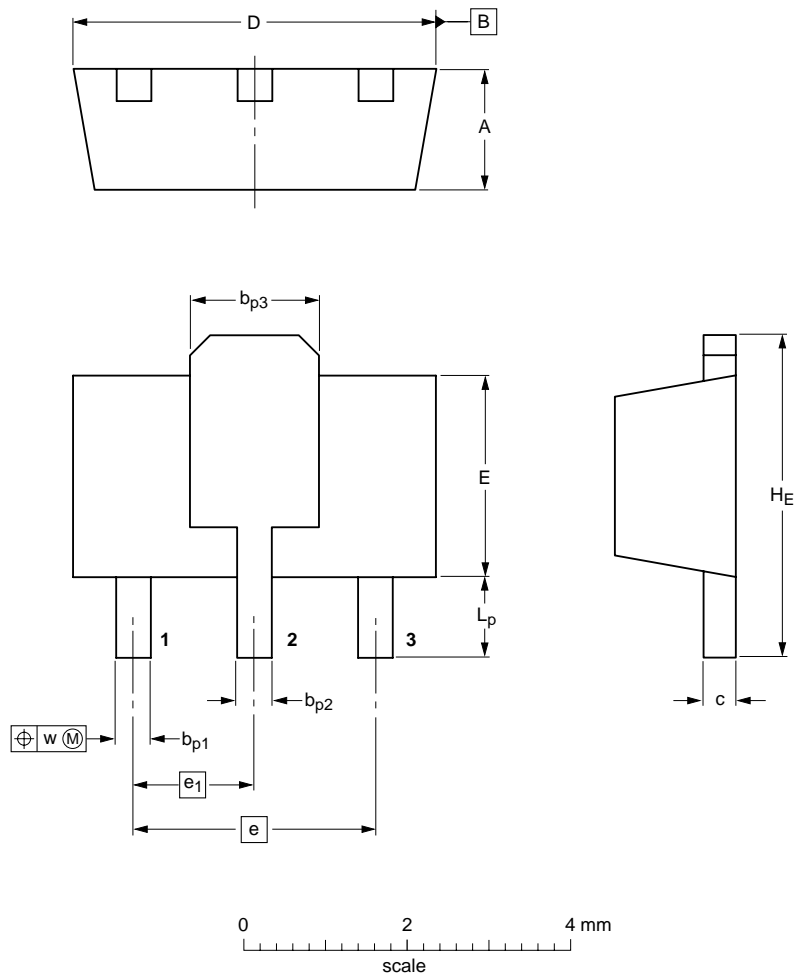

DIMENSIONS (mm are the original dimensions)

UNIT	A	b <sub>p1</sub>	b <sub>p2</sub>	b <sub>p3</sub>	c	D	E	e	e <sub>1</sub>	H <sub>E</sub>	L <sub>p</sub>	w
mm	1.6 1.4	0.48 0.35	0.53 0.40	1.8 1.4	0.44 0.23	4.6 4.4	2.6 2.4	3.0	1.5	4.25 3.75	1.2 0.8	0.13

OUTLINE VERSION	REFERENCES			EUROPEAN PROJECTION	ISSUE DATE
	IEC	JEDEC	JEITA		
SOT89		TO-243	SC-62		99-09-13 04-08-03



## Voltage regulator diodes

## BZV49 series

## DATA SHEET STATUS

LEVEL	DATA SHEET STATUS <sup>(1)</sup>	PRODUCT STATUS <sup>(2)(3)</sup>	DEFINITION
I	Objective data	Development	This data sheet contains data from the objective specification for product development. Philips Semiconductors reserves the right to change the specification in any manner without notice.
II	Preliminary data	Qualification	This data sheet contains data from the preliminary specification. Supplementary data will be published at a later date. Philips Semiconductors reserves the right to change the specification without notice, in order to improve the design and supply the best possible product.
III	Product data	Production	This data sheet contains data from the product specification. Philips Semiconductors reserves the right to make changes at any time in order to improve the design, manufacturing and supply. Relevant changes will be communicated via a Customer Product/Process Change Notification (CPCN).

## Notes

1. Please consult the most recently issued data sheet before initiating or completing a design.
2. The product status of the device(s) described in this data sheet may have changed since this data sheet was published. The latest information is available on the Internet at URL <http://www.semiconductors.philips.com>.
3. For data sheets describing multiple type numbers, the highest-level product status determines the data sheet status.

## DEFINITIONS

**Short-form specification** — The data in a short-form specification is extracted from a full data sheet with the same type number and title. For detailed information see the relevant data sheet or data handbook.

**Limiting values definition** — Limiting values given are in accordance with the Absolute Maximum Rating System (IEC 60134). Stress above one or more of the limiting values may cause permanent damage to the device. These are stress ratings only and operation of the device at these or at any other conditions above those given in the Characteristics sections of the specification is not implied. Exposure to limiting values for extended periods may affect device reliability.

**Application information** — Applications that are described herein for any of these products are for illustrative purposes only. Philips Semiconductors make no representation or warranty that such applications will be suitable for the specified use without further testing or modification.

## DISCLAIMERS

**Life support applications** — These products are not designed for use in life support appliances, devices, or systems where malfunction of these products can reasonably be expected to result in personal injury. Philips Semiconductors customers using or selling these products for use in such applications do so at their own risk and agree to fully indemnify Philips Semiconductors for any damages resulting from such application.

**Right to make changes** — Philips Semiconductors reserves the right to make changes in the products - including circuits, standard cells, and/or software - described or contained herein in order to improve design and/or performance. When the product is in full production (status 'Production'), relevant changes will be communicated via a Customer Product/Process Change Notification (CPCN). Philips Semiconductors assumes no responsibility or liability for the use of any of these products, conveys no licence or title under any patent, copyright, or mask work right to these products, and makes no representations or warranties that these products are free from patent, copyright, or mask work right infringement, unless otherwise specified.

# ***Philips Semiconductors – a worldwide company***

## **Contact information**

For additional information please visit <http://www.semiconductors.philips.com>. Fax: +31 40 27 24825

For sales offices addresses send e-mail to: [sales.addresses@www.semiconductors.philips.com](mailto:sales.addresses@www.semiconductors.philips.com).

© Koninklijke Philips Electronics N.V. 2005

SCA76

All rights are reserved. Reproduction in whole or in part is prohibited without the prior written consent of the copyright owner.

The information presented in this document does not form part of any quotation or contract, is believed to be accurate and reliable and may be changed without notice. No liability will be accepted by the publisher for any consequence of its use. Publication thereof does not convey nor imply any license under patent- or other industrial or intellectual property rights.

Printed in The Netherlands

R76/04/pp10

Date of release: 2005 Feb 03

Document order number: 9397 750 13926

*Let's make things better.*

**Philips  
Semiconductors**



**PHILIPS**