

24-V Input Voltage, 150-mA, Ultralow I_Q Low-Dropout Regulators

FEATURES

- **Wide Input Voltage Range: 2.5 V to 24 V**
- **Low 3.2- μ A Quiescent Current**
- **Ground Pin Current: 3.4 μ A at 100-mA I_{OUT}**
- **Stable with Any Capacitor ($> 0.47 \mu$ F)**
- **Operating Junction Temperature: -40°C to $+125^\circ\text{C}$**
- **Available in SOT23-5 Package**
 - See *Package Option Addendum* at end of this document for complete list of available voltage options

APPLICATIONS

- **Ultralow Power Microcontrollers**
- **E-Meters**
- **Fire Alarms/Smoke Detector Systems**
- **Handset Peripherals**
- **Industrial/Automotive Applications**
- **Remote Controllers**
- **Zigbee™ Networks**
- **PDA's**
- **Portable, Battery-Powered Equipment**

DESCRIPTION

The TLV704xx series of low dropout (LDO) regulators are ultralow quiescent current devices designed for extremely power-sensitive applications. Quiescent current is virtually constant over the complete load current and ambient temperature range. These devices are an ideal power management attachment to low-power microcontrollers, such as the [MSP430](#).

The TLV704xx operate over a wide operating input voltage of 2.5 V to 24 V. Thus, it is an excellent choice for both battery-powered systems as well as industrial applications that see large line transients.

The TLV704xx is available in a 3-mm \times 3-mm SOT23-5 package, which is ideal for cost-effective board manufacturing.

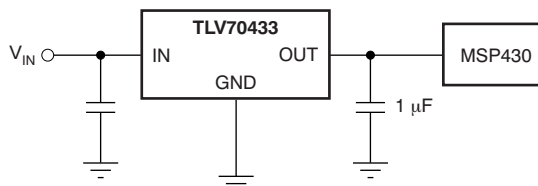
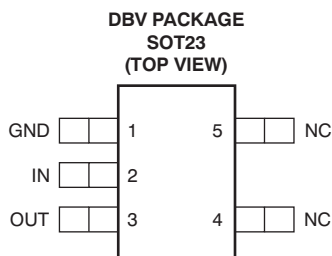

Please be aware that an important notice concerning availability, standard warranty, and use in critical applications of Texas Instruments semiconductor products and disclaimers thereto appears at the end of this data sheet.

ZigBee is a trademark of ZigBee Alliance.

All other trademarks are the property of their respective owners.



This integrated circuit can be damaged by ESD. Texas Instruments recommends that all integrated circuits be handled with appropriate precautions. Failure to observe proper handling and installation procedures can cause damage.

ESD damage can range from subtle performance degradation to complete device failure. Precision integrated circuits may be more susceptible to damage because very small parametric changes could cause the device not to meet its published specifications.

AVAILABLE OPTIONS⁽¹⁾

PRODUCT	V _{OUT}
TLV704xxyyyz	XX is nominal output voltage (for example 33 = 3.3 V) YYY is Package Designator Z is Package Quantity

- (1) For the most current package and ordering information, see the Package Option Addendum at the end of this document, or visit the device product folder at www.ti.com.

ABSOLUTE MAXIMUM RATINGS⁽¹⁾

Over operating free-air temperature range, unless otherwise noted.

		VALUE		UNIT
		MIN	MAX	
Voltage ⁽²⁾	IN	-0.3	24	V
Current source	OUT	Internally limited		
Temperature	Operating junction, T _J	-40	+150	°C
	Storage, T _{stg}	-65	+150	°C
Electrostatic Discharge Rating ⁽³⁾	Human body model (HBM) QSS 009-105 (JEDEC22-A114A)		2	kV
	Charge device model (CDM) QSS 009-147 (JEDEC22-C101B.01)		500	V

- (1) Stresses beyond those listed under *absolute maximum ratings* may cause permanent damage to the device. These are stress ratings only, and functional operation of the device at these or any other conditions beyond those indicated under *recommended operating conditions* is not implied. Exposure to absolute-maximum-rated conditions for extended periods may affect device reliability.
- (2) All voltages are with respect to network ground terminal.
- (3) ESD testing is performed according to the respective JEDEC standard.

THERMAL INFORMATION

THERMAL METRIC ⁽¹⁾		TLV70433DBV	UNITS
		DBV	
		5 PINS	
θ_{JA}	Junction-to-ambient thermal resistance	213.1	°C/W
θ_{JcTop}	Junction-to-case (top) thermal resistance	110.9	
θ_{JB}	Junction-to-board thermal resistance	97.4	
ψ_{JT}	Junction-to-top characterization parameter	22.0	
ψ_{JB}	Junction-to-board characterization parameter	78.4	
θ_{JcBot}	Junction-to-case (bottom) thermal resistance	n/a	

- (1) For more information about traditional and new thermal metrics, see the *IC Package Thermal Metrics* application report, [SPRA953](http://www.ti.com/lit/zip/spra953).

POWER DISSIPATION RATING TABLE

BOARD	PACKAGE	R _{θJA}	T _A ≤ 25°C POWER RATING	T _A = +70°C POWER RATING	T _A = +85°C POWER RATING
High-K ⁽¹⁾	DBV	213.1 °C/W	470 mW	258 mW	188 mW

- (1) The JEDEC High-K (2s2p) board design used to derive this data was a 3-inch × 3-inch, multilayer board with 1-ounce internal power and ground planes and 2-ounce copper traces on top and bottom of the board.

ELECTRICAL CHARACTERISTICS

All values are at $T_A = +25^\circ\text{C}$, $V_{IN} = V_{OUT(nom)} + 1\text{ V}$, $I_{OUT} = 1\text{ mA}$, and $C_{OUT} = 1\text{ }\mu\text{F}$, unless otherwise noted.

PARAMETER	TEST CONDITIONS	TLV704xx			UNIT	
		MIN	TYP	MAX		
V_O	Input voltage range			24	V	
	Output voltage range	1.2		5	V	
V_{OUT}	DC output accuracy	-2		2	%	
ΔV_O for ΔV_{IN}	Line regulation	$V_{OUT(NOM)} + 1\text{ V} < V_{IN} < 24\text{ V}$		20	50	mV
ΔV_O for ΔI_{OUT}	Load regulation	$V_{OUT} \leq 3.3\text{ V}$	$0\text{ mA} < I_{OUT} < 10\text{ mA}$	10		mV
			$0\text{ mA} < I_{OUT} < 50\text{ mA}$	25		mV
			$0\text{ mA} < I_{OUT} < 100\text{ mA}$	33	50	mV
		$V_{OUT} \geq 3.3\text{ V}$	$0\text{ mA} < I_{OUT} < 10\text{ mA}$	7		mV
			$0\text{ mA} < I_{OUT} < 50\text{ mA}$	35		mV
			$0\text{ mA} < I_{OUT} < 100\text{ mA}$	50	75	mV
V_{DO}	Dropout voltage ⁽¹⁾	$I_{OUT} = 10\text{ mA}$		75	mV	
		$I_{OUT} = 50\text{ mA}$		400	mV	
		$I_{OUT} = 100\text{ mA}$		850	1100	mV
I_{CL}	Output current limit	$V_{OUT} = 0\text{ V}$	160		1000	mA
I_{GND}	Ground pin current	$I_{OUT} = 0\text{ mA}$		3.2	4.5	μA
		$I_{OUT} = 100\text{ mA}$		3.4	5.5	μA
PSRR	Power-supply rejection ratio	$f = 100\text{ kHz}$, $C_{OUT} = 10\text{ }\mu\text{F}$		60		dB
T_J	Operating junction temperature		-40		+125	$^\circ\text{C}$

(1) $V_{IN} = V_{OUT(NOM)} - 0.1\text{ V}$.

FUNCTIONAL BLOCK DIAGRAM

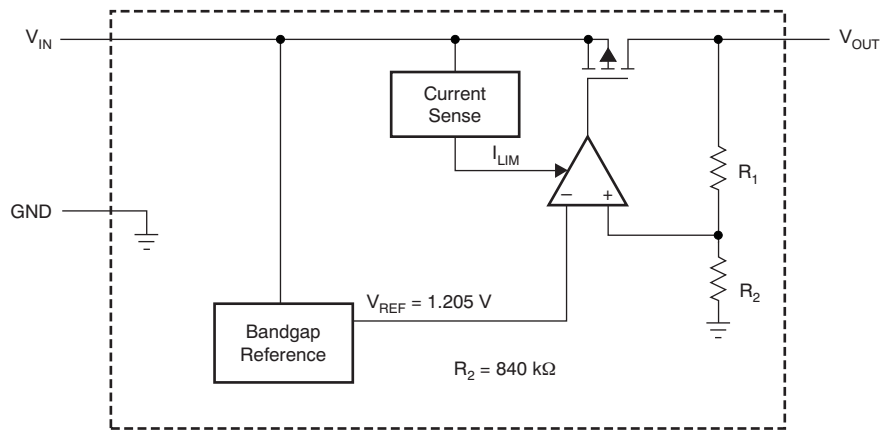

Table 1. Pin Descriptions

TLV704xx		DESCRIPTION
NAME	DBV	
GND	1	Ground
IN	2	Unregulated input voltage.
OUT	3	Regulated output voltage. Any capacitor greater than 1 μF between this pin and ground is needed for stability.
NC	4, 5	No connection. This pin can be left open or tied to ground for improved thermal performance.

TYPICAL CHARACTERISTICS

LINE REGULATION

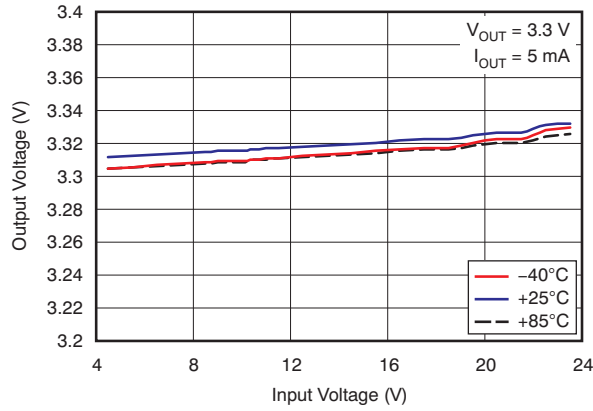

Figure 1.

LOAD REGULATION
($V_{OUT} = 3.3\text{ V}$)

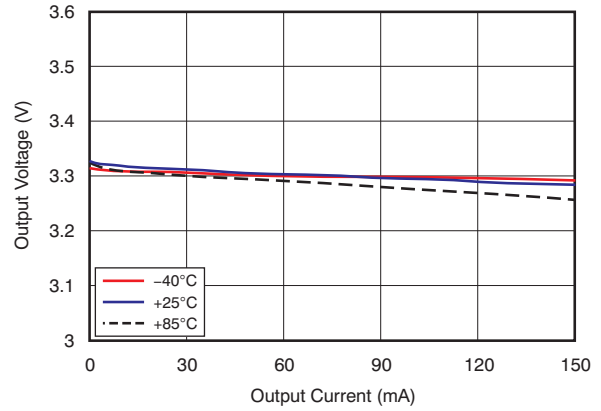

Figure 2.

OUTPUT VOLTAGE vs
JUNCTION TEMPERATURE

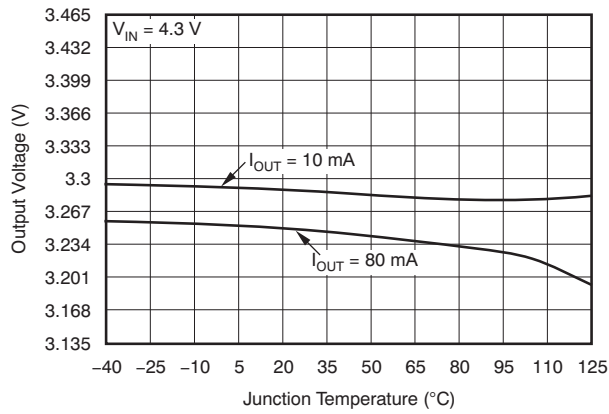

Figure 3.

DROPOUT VOLTAGE vs INPUT VOLTAGE
TLV70433

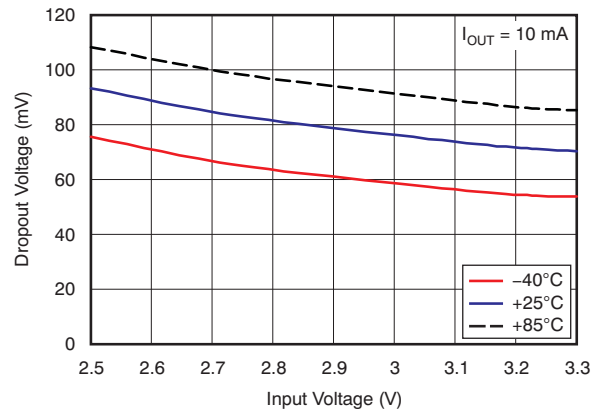

Figure 4.

DROPOUT VOLTAGE vs OUTPUT CURRENT

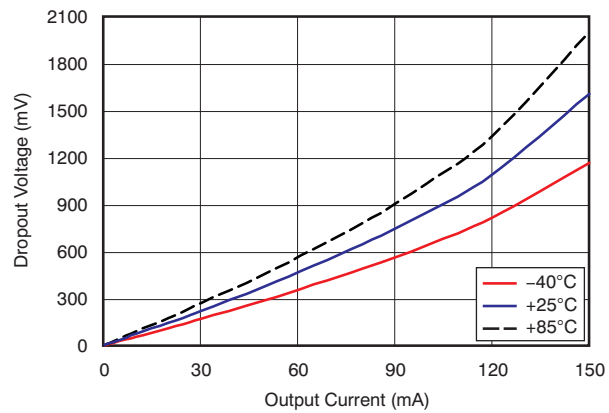

Figure 5.

GROUND CURRENT vs JUNCTION TEMPERATURE

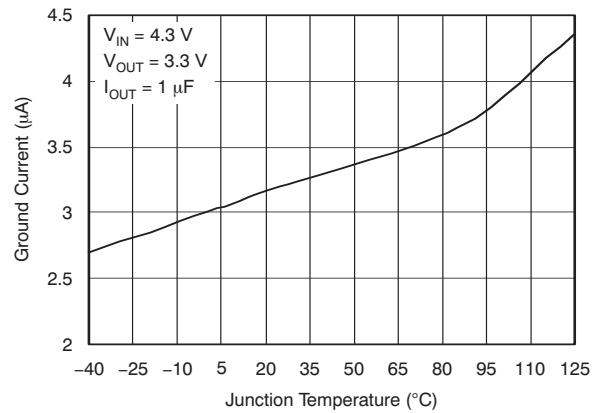

Figure 6.

TYPICAL CHARACTERISTICS (continued)

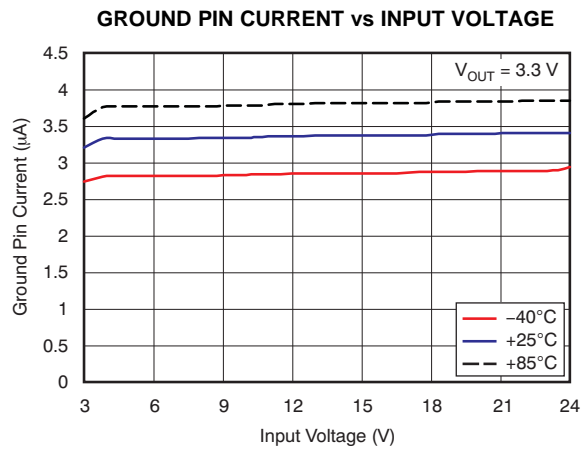

Figure 7.

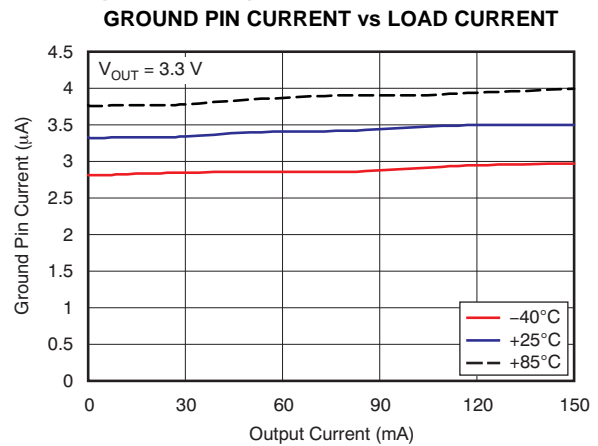

Figure 8.

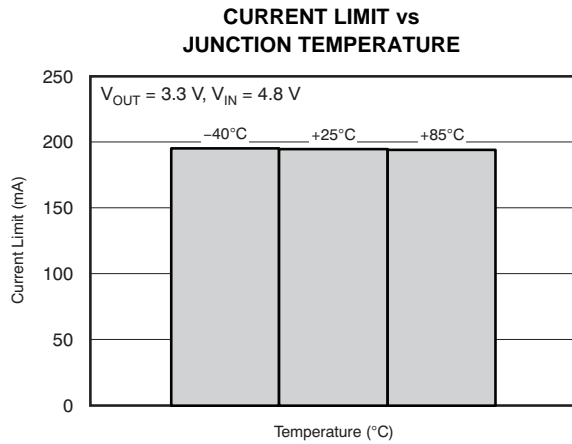

Figure 9.

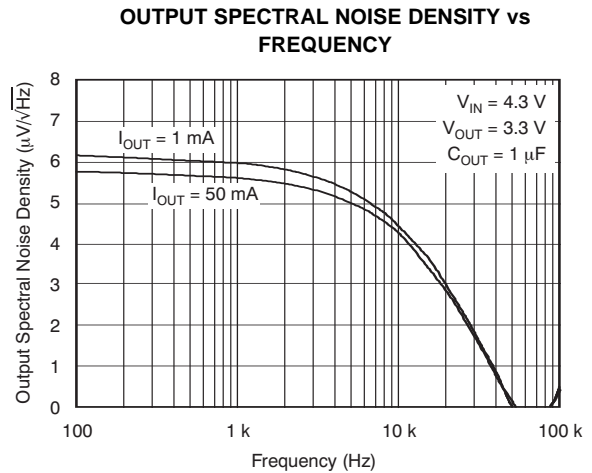

Figure 10.

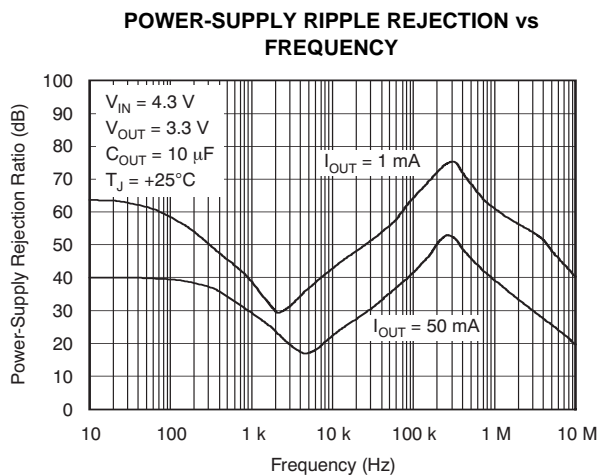

Figure 11.

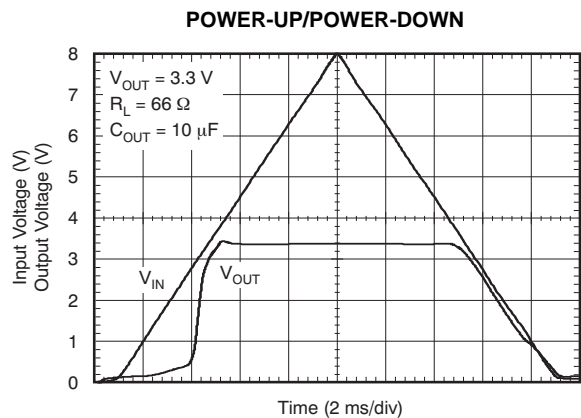

Figure 12.

TYPICAL CHARACTERISTICS (continued)

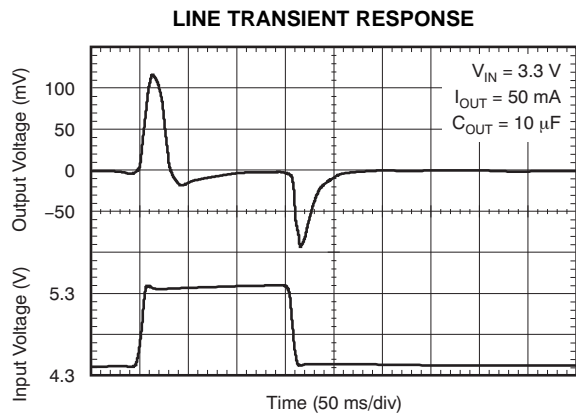

Figure 13.

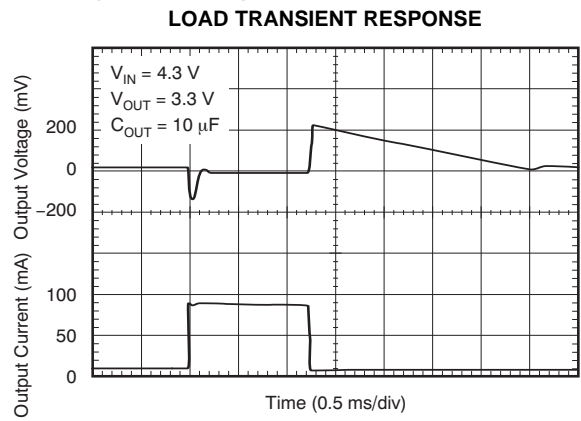

Figure 14.

APPLICATION INFORMATION

The TLV704xx series belong to a family of ultralow I_Q LDO regulators. I_Q remains fairly constant over the complete output load current and temperature range. The devices are ensured to operate over a temperature range of -40°C to $+125^{\circ}\text{C}$.

INPUT AND OUTPUT CAPACITOR REQUIREMENTS

The TLV704 requires a 1- μF or larger capacitor connected between OUT and GND for stability. Ceramic or tantalum capacitors can be used. Larger value capacitors result in better transient and noise performance.

Although an input capacitor is not required for stability, when a 0.1- μF or larger capacitor is placed between IN and GND, it counteracts reactive input sources and improves transient and noise performance. Higher value capacitors are necessary if large, fast rise time load transients are anticipated.

BOARD LAYOUT RECOMMENDATIONS

Input and output capacitors should be placed as close to the device pins as possible. To avoid interference of noise and ripple on the board, it is recommended that the board be designed with separate ground planes for V_{IN} and V_{OUT} , with the ground plane connected only at the device GND pin. In addition, the ground connection for the output capacitor should be connected directly to the device GND pin.

POWER DISSIPATION AND JUNCTION TEMPERATURE

To ensure reliable operation, worst-case junction temperature should not exceed $+125^{\circ}\text{C}$. This restriction limits the power dissipation the regulator can handle in any given application. To ensure the junction temperature is within acceptable limits, calculate the maximum allowable dissipation, $P_{\text{D(max)}}$, and the actual dissipation, P_{D} , which must be less than or equal to $P_{\text{D(max)}}$.

The maximum power dissipation limit is determined using Equation 1:

$$P_{\text{D(max)}} = \frac{T_{\text{J max}} - T_{\text{A}}}{R_{\theta\text{JA}}} \quad (1)$$

where:

$T_{\text{J max}}$ is the maximum allowable junction temperature.

$R_{\theta\text{JA}}$ is the thermal resistance junction-to-ambient for the package (see the [Power Dissipation Rating](#) table).

T_{A} is the ambient temperature.

The regulator dissipation is calculated using Equation 2:

$$P_{\text{D}} = (V_{\text{IN}} - V_{\text{OUT}}) \times I_{\text{OUT}} \quad (2)$$

Power dissipation resulting from quiescent current is negligible.

REGULATOR PROTECTION

The TLV704xx series of LDO regulators use a PMOS-pass transistor that has a built-in back diode that conducts reverse current when the input voltage drops below the output voltage (for example, during power-down). Current is conducted from the output to the input and is not internally limited. If extended reverse voltage operation is anticipated, external limiting might be appropriate.

The TLV704xx features internal current limiting. During normal operation, the TLV704xx limits output current to approximately 250 mA. When current limiting engages, the output voltage scales back linearly until the overcurrent condition ends. Take care not to exceed the rated maximum operating junction temperature of $+125^{\circ}\text{C}$. Continuously running the device under conditions where the junction temperature exceeds $+125^{\circ}\text{C}$ degrades device reliability.

The ability to remove heat from the die is different for each package type, presenting different considerations in the printed circuit board (PCB) layout. The PCB area around the device that is free of other components moves the heat from the device to the ambient air. Performance data for JEDEC high-K boards are given in the [Power Dissipation Rating](#) table. Using heavier copper increases the effectiveness in removing heat from the device. The addition of plated through-holes to heat-dissipating layers also improves heatsink effectiveness. Power dissipation depends on input voltage and load conditions. Power dissipation (P_{D}) is equal to the product of the output current and the voltage drop across the output pass element, as shown in Equation 2.

PACKAGE MOUNTING

Solder pad footprint recommendations for the TLV704xx are available from the Texas Instruments web site at www.ti.com through the [TLV704 series product folders](#). The recommended land pattern for the DBV package is appended to this data sheet.

REVISION HISTORY

NOTE: Page numbers for previous revisions may differ from page numbers in the current version.

Changes from Revision B (November, 2010) to Revision C	Page
• Revised document to reflect PK package option removal	1
• Removed SOT89 (PK) package from front-page figure	1
• Revised <i>Thermal Information</i> table and <i>Power Dissipation Rating</i> table	2
• Added load regulation specifications for $V_{OUT} \geq 3.3\text{ V}$	3
• Deleted PK package information from <i>Pin Descriptions</i> table	3
• Removed Figure 15 and Figure 16	7
<hr/>	
Changes from Revision A (October, 2010) to Revision B	Page
• Updated document to reflect availability of PK package option	1
• Corrected typo in front-page figure	1
• Changed <i>Pin Descriptions</i> table to correct pin numbering for PK package option	3
• Revised <i>Typical Characteristics</i> section; added and removed graphs	4
• Updated format of <i>Application Information</i> section	7
• Added <i>Package Mounting</i> section and	7

PACKAGING INFORMATION

Orderable Device	Status ⁽¹⁾	Package Type	Package Drawing	Pins	Package Qty	Eco Plan ⁽²⁾	Lead/ Ball Finish	MSL Peak Temp ⁽³⁾	Samples (Requires Login)
TLV70430DBVR	ACTIVE	SOT-23	DBV	5	3000	Green (RoHS & no Sb/Br)	CU NIPDAU	Level-1-260C-UNLIM	
TLV70430DBVT	ACTIVE	SOT-23	DBV	5	250	Green (RoHS & no Sb/Br)	CU NIPDAU	Level-1-260C-UNLIM	
TLV70433DBVR	ACTIVE	SOT-23	DBV	5	3000	Green (RoHS & no Sb/Br)	CU NIPDAU	Level-1-260C-UNLIM	
TLV70433DBVT	ACTIVE	SOT-23	DBV	5	250	Green (RoHS & no Sb/Br)	CU NIPDAU	Level-1-260C-UNLIM	
TLV70436DBVR	ACTIVE	SOT-23	DBV	5	3000	Green (RoHS & no Sb/Br)	CU NIPDAU	Level-1-260C-UNLIM	
TLV70436DBVT	ACTIVE	SOT-23	DBV	5	250	Green (RoHS & no Sb/Br)	CU NIPDAU	Level-1-260C-UNLIM	
TLV70450DBVR	ACTIVE	SOT-23	DBV	5	3000	Green (RoHS & no Sb/Br)	CU NIPDAU	Level-1-260C-UNLIM	
TLV70450DBVT	ACTIVE	SOT-23	DBV	5	250	Green (RoHS & no Sb/Br)	CU NIPDAU	Level-1-260C-UNLIM	

⁽¹⁾ The marketing status values are defined as follows:

ACTIVE: Product device recommended for new designs.

LIFEBUY: TI has announced that the device will be discontinued, and a lifetime-buy period is in effect.

NRND: Not recommended for new designs. Device is in production to support existing customers, but TI does not recommend using this part in a new design.

PREVIEW: Device has been announced but is not in production. Samples may or may not be available.

OBSOLETE: TI has discontinued the production of the device.

⁽²⁾ Eco Plan - The planned eco-friendly classification: Pb-Free (RoHS), Pb-Free (RoHS Exempt), or Green (RoHS & no Sb/Br) - please check <http://www.ti.com/productcontent> for the latest availability information and additional product content details.

TBD: The Pb-Free/Green conversion plan has not been defined.

Pb-Free (RoHS): TI's terms "Lead-Free" or "Pb-Free" mean semiconductor products that are compatible with the current RoHS requirements for all 6 substances, including the requirement that lead not exceed 0.1% by weight in homogeneous materials. Where designed to be soldered at high temperatures, TI Pb-Free products are suitable for use in specified lead-free processes.

Pb-Free (RoHS Exempt): This component has a RoHS exemption for either 1) lead-based flip-chip solder bumps used between the die and package, or 2) lead-based die adhesive used between the die and leadframe. The component is otherwise considered Pb-Free (RoHS compatible) as defined above.

Green (RoHS & no Sb/Br): TI defines "Green" to mean Pb-Free (RoHS compatible), and free of Bromine (Br) and Antimony (Sb) based flame retardants (Br or Sb do not exceed 0.1% by weight in homogeneous material)

⁽³⁾ MSL, Peak Temp. -- The Moisture Sensitivity Level rating according to the JEDEC industry standard classifications, and peak solder temperature.

Important Information and Disclaimer: The information provided on this page represents TI's knowledge and belief as of the date that it is provided. TI bases its knowledge and belief on information provided by third parties, and makes no representation or warranty as to the accuracy of such information. Efforts are underway to better integrate information from third parties. TI has taken and continues to take reasonable steps to provide representative and accurate information but may not have conducted destructive testing or chemical analysis on incoming materials and chemicals. TI and TI suppliers consider certain information to be proprietary, and thus CAS numbers and other limited information may not be available for release.

In no event shall TI's liability arising out of such information exceed the total purchase price of the TI part(s) at issue in this document sold by TI to Customer on an annual basis.

TAPE AND REEL INFORMATION
REEL DIMENSIONS

TAPE DIMENSIONS

A0	Dimension designed to accommodate the component width
B0	Dimension designed to accommodate the component length
K0	Dimension designed to accommodate the component thickness
W	Overall width of the carrier tape
P1	Pitch between successive cavity centers

TAPE AND REEL INFORMATION

*All dimensions are nominal

Device	Package Type	Package Drawing	Pins	SPQ	Reel Diameter (mm)	Reel Width W1 (mm)	A0 (mm)	B0 (mm)	K0 (mm)	P1 (mm)	W (mm)	Pin1 Quadrant
TLV70430DBVR	SOT-23	DBV	5	3000	178.0	9.0	3.23	3.17	1.37	4.0	8.0	Q3
TLV70433DBVR	SOT-23	DBV	5	3000	178.0	9.0	3.23	3.17	1.37	4.0	8.0	Q3
TLV70436DBVR	SOT-23	DBV	5	3000	178.0	9.0	3.23	3.17	1.37	4.0	8.0	Q3
TLV70450DBVR	SOT-23	DBV	5	3000	178.0	9.0	3.23	3.17	1.37	4.0	8.0	Q3

TAPE AND REEL BOX DIMENSIONS

*All dimensions are nominal

Device	Package Type	Package Drawing	Pins	SPQ	Length (mm)	Width (mm)	Height (mm)
TLV70430DBVR	SOT-23	DBV	5	3000	180.0	180.0	18.0
TLV70433DBVR	SOT-23	DBV	5	3000	180.0	180.0	18.0
TLV70436DBVR	SOT-23	DBV	5	3000	180.0	180.0	18.0
TLV70450DBVR	SOT-23	DBV	5	3000	180.0	180.0	18.0

DBV (R-PDSO-G5)

PLASTIC SMALL-OUTLINE PACKAGE



- NOTES:
- A. All linear dimensions are in millimeters.
 - B. This drawing is subject to change without notice.
 - C. Body dimensions do not include mold flash or protrusion. Mold flash and protrusion shall not exceed 0.15 per side.
 - D. Falls within JEDEC MO-178 Variation AA.

DBV (R-PDSO-G5)

PLASTIC SMALL OUTLINE



- NOTES:
- A. All linear dimensions are in millimeters.
 - B. This drawing is subject to change without notice.
 - C. Customers should place a note on the circuit board fabrication drawing not to alter the center solder mask defined pad.
 - D. Publication IPC-7351 is recommended for alternate designs.
 - E. Laser cutting apertures with trapezoidal walls and also rounding corners will offer better paste release. Customers should contact their board assembly site for stencil design recommendations. Example stencil design based on a 50% volumetric metal load solder paste. Refer to IPC-7525 for other stencil recommendations.

IMPORTANT NOTICE

Texas Instruments Incorporated and its subsidiaries (TI) reserve the right to make corrections, modifications, enhancements, improvements, and other changes to its products and services at any time and to discontinue any product or service without notice. Customers should obtain the latest relevant information before placing orders and should verify that such information is current and complete. All products are sold subject to TI's terms and conditions of sale supplied at the time of order acknowledgment.

TI warrants performance of its hardware products to the specifications applicable at the time of sale in accordance with TI's standard warranty. Testing and other quality control techniques are used to the extent TI deems necessary to support this warranty. Except where mandated by government requirements, testing of all parameters of each product is not necessarily performed.

TI assumes no liability for applications assistance or customer product design. Customers are responsible for their products and applications using TI components. To minimize the risks associated with customer products and applications, customers should provide adequate design and operating safeguards.

TI does not warrant or represent that any license, either express or implied, is granted under any TI patent right, copyright, mask work right, or other TI intellectual property right relating to any combination, machine, or process in which TI products or services are used. Information published by TI regarding third-party products or services does not constitute a license from TI to use such products or services or a warranty or endorsement thereof. Use of such information may require a license from a third party under the patents or other intellectual property of the third party, or a license from TI under the patents or other intellectual property of TI.

Reproduction of TI information in TI data books or data sheets is permissible only if reproduction is without alteration and is accompanied by all associated warranties, conditions, limitations, and notices. Reproduction of this information with alteration is an unfair and deceptive business practice. TI is not responsible or liable for such altered documentation. Information of third parties may be subject to additional restrictions.

Resale of TI products or services with statements different from or beyond the parameters stated by TI for that product or service voids all express and any implied warranties for the associated TI product or service and is an unfair and deceptive business practice. TI is not responsible or liable for any such statements.

TI products are not authorized for use in safety-critical applications (such as life support) where a failure of the TI product would reasonably be expected to cause severe personal injury or death, unless officers of the parties have executed an agreement specifically governing such use. Buyers represent that they have all necessary expertise in the safety and regulatory ramifications of their applications, and acknowledge and agree that they are solely responsible for all legal, regulatory and safety-related requirements concerning their products and any use of TI products in such safety-critical applications, notwithstanding any applications-related information or support that may be provided by TI. Further, Buyers must fully indemnify TI and its representatives against any damages arising out of the use of TI products in such safety-critical applications.

TI products are neither designed nor intended for use in military/aerospace applications or environments unless the TI products are specifically designated by TI as military-grade or "enhanced plastic." Only products designated by TI as military-grade meet military specifications. Buyers acknowledge and agree that any such use of TI products which TI has not designated as military-grade is solely at the Buyer's risk, and that they are solely responsible for compliance with all legal and regulatory requirements in connection with such use.

TI products are neither designed nor intended for use in automotive applications or environments unless the specific TI products are designated by TI as compliant with ISO/TS 16949 requirements. Buyers acknowledge and agree that, if they use any non-designated products in automotive applications, TI will not be responsible for any failure to meet such requirements.

Following are URLs where you can obtain information on other Texas Instruments products and application solutions:

Products

Audio	www.ti.com/audio
Amplifiers	amplifier.ti.com
Data Converters	dataconverter.ti.com
DLP® Products	www.dlp.com
DSP	dsp.ti.com
Clocks and Timers	www.ti.com/clocks
Interface	interface.ti.com
Logic	logic.ti.com
Power Mgmt	power.ti.com
Microcontrollers	microcontroller.ti.com
RFID	www.ti-rfid.com
OMAP Mobile Processors	www.ti.com/omap
Wireless Connectivity	www.ti.com/wirelessconnectivity

Applications

Automotive and Transportation	www.ti.com/automotive
Communications and Telecom	www.ti.com/communications
Computers and Peripherals	www.ti.com/computers
Consumer Electronics	www.ti.com/consumer-apps
Energy and Lighting	www.ti.com/energy
Industrial	www.ti.com/industrial
Medical	www.ti.com/medical
Security	www.ti.com/security
Space, Avionics and Defense	www.ti.com/space-avionics-defense
Video and Imaging	www.ti.com/video

TI E2E Community Home Page

e2e.ti.com

Mailing Address: Texas Instruments, Post Office Box 655303, Dallas, Texas 75265
Copyright © 2012, Texas Instruments Incorporated